

554

SCIENTIFIC LIBRARY

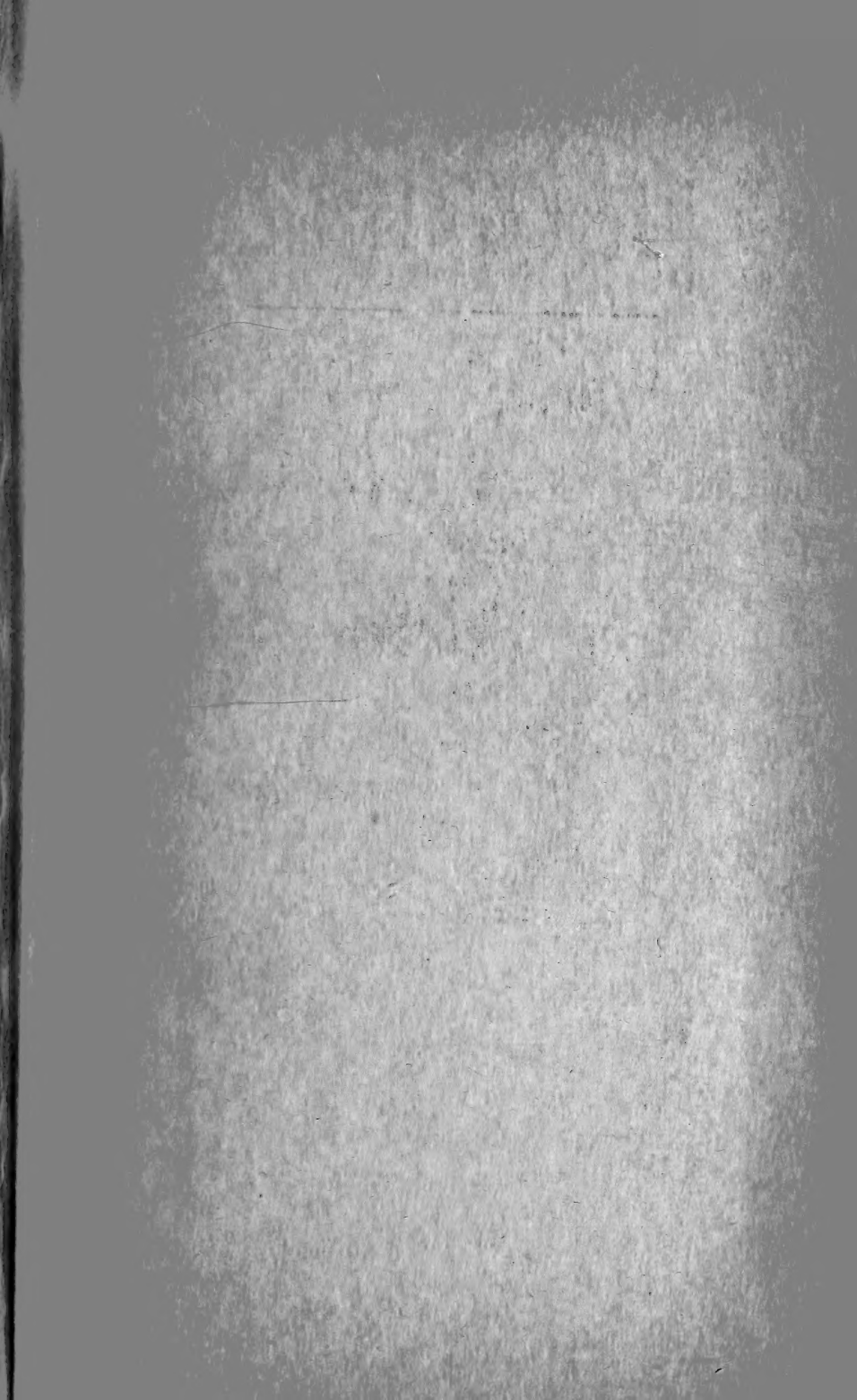

UNITED STATES PATENT OFFICE



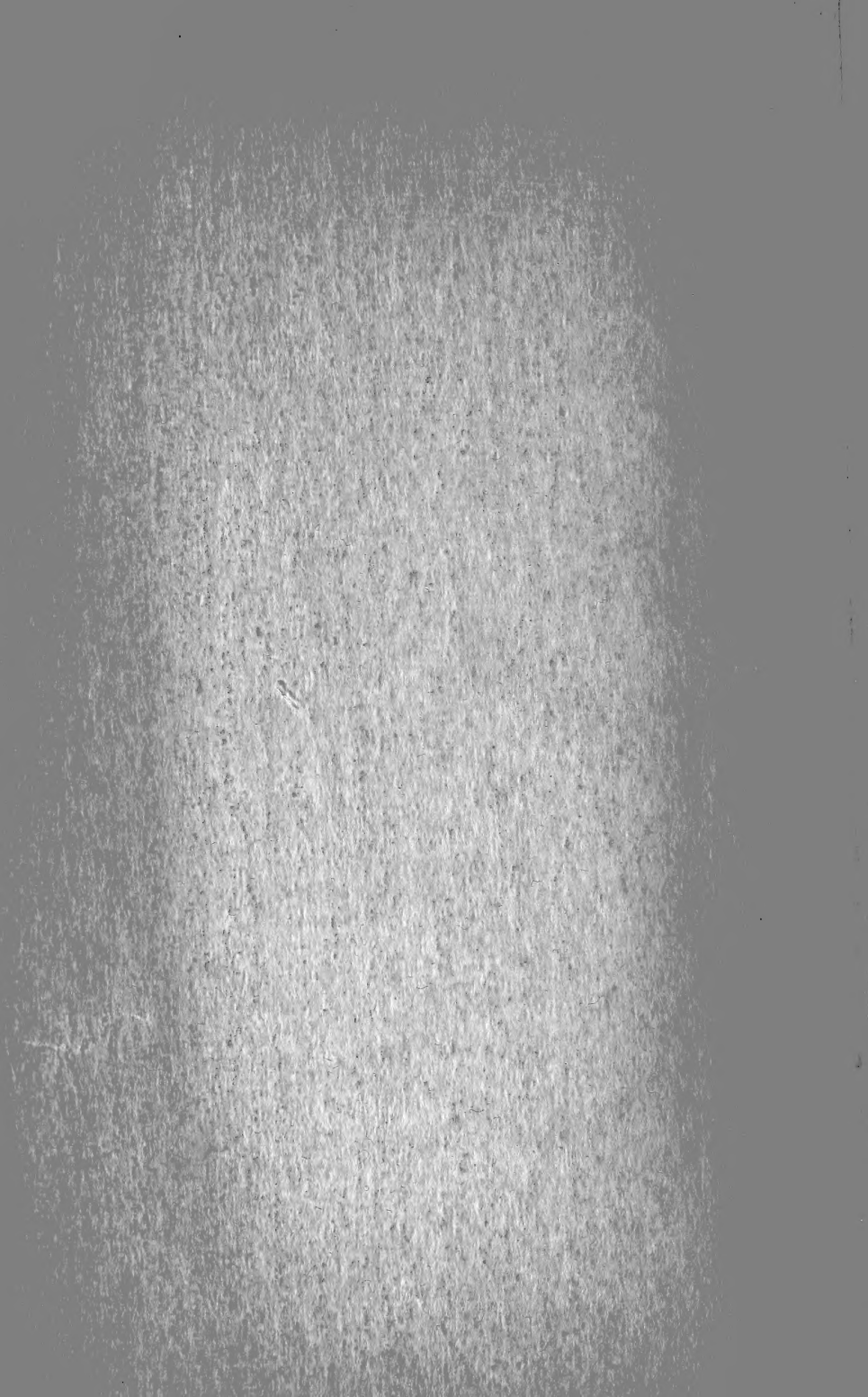

39082
Int
51

THE
LONDON, EDINBURGH, AND DUBLIN
PHILOSOPHICAL MAGAZINE
AND
JOURNAL OF SCIENCE.

CONDUCTED BY

SIR OLIVER JOSEPH LODGE, D.Sc., LL.D., F.R.S.
SIR JOSEPH JOHN THOMSON, M.A., Sc.D., LL.D., F.R.S.
JOHN JOLY, M.A., D.Sc., F.R.S., F.G.S.
GEORGE CAREY FOSTER, B.A., LL.D., F.R.S.

AND

WILLIAM FRANCIS, F.L.S.

51

"Nec aranearum sane textus ideo melior quia ex se fila gignunt, nec noster vilior quia ex alienis libamus ut apes." JUST. LIPS. *Polit. lib. i. cap. 1. Not.*

18191

VOL. XXVI.—SIXTH SERIES.
JULY—DECEMBER 1913.

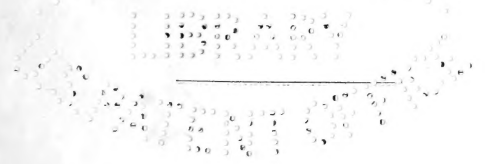

LONDON:

TAYLOR AND FRANCIS, RED LION COURT, FLEET STREET.

SOLD BY SIMPKIN, MARSHALL, HAMILTON, KENT, AND CO., LD.
SMITH AND SON, GLASGOW;—HODGES, FIGGIS, AND CO., DUBLIN;
VEUVE J. BOYVEAU, PARIS;—AND ASHER AND CO., BERLIN.

Q
1
P5

“Meditationis est perscrutari occulta; contemplationis est admirari perspicua . . . Admiratio generat quæstionem, quæstio investigationem, investigatio inventionem.”—*Hugo de S. Victore.*

—“Cur spirent venti, cur terra dehiscat,
Cur mare turgescat, pelago cur tantus amaror,
Cur caput obscura Phœbus ferrugine condat,
Quid toties diros cogat flagrare cometas,
Quid pariat nubes, veniant cur fulmina cœlo,
Quo micet igne Iris, superos quis conciat orbes
Tam vario motu.”

J. B. Pinelli ad Mazonium.



CONTENTS OF VOL. XXVI.

(SIXTH SERIES).

NUMBER CLI.—JULY 1913.

	Page
Dr. N. Bohr on the Constitution of Atoms and Molecules . .	1
Dr. A. C. Crehore on the Formation of the Molecules of the Elements and their Compounds, with Atoms as constituted on the Corpuscular-Ring Theory. (Plates I. & II.)	25
Messrs. R. M. Deeley and P. H. Parr on the Viscosity of Glacier Ice. (Plate III.)	85
Prof. E. H. Barton on Range and Sharpness of Resonance under Sustained Forcing and their Variations with Pitch. .	111
Prof. D. N. Mallik on Fermat's Law	144
Mr. D. E. Roberts on the Effect of Temperature and Magnetization on the Resistance of Graphite	158
Prof. R. W. Wood on the Use of the Interferometer for the Study of Band Spectra. (Plate IV.)	176
Mr. H. C. Stevens on the Flicker Photometer and the Iris . .	180
Dr. R. T. Beatty on the Energy required to Ionize an Atom. 183	
Dr. T. J. F. A. Bromwich on the Ballistic Galvanometer . . .	186
Mr. A. Norman Shaw on Interference Phenomena with Gamma Rays. (Plate V.)	190
Lord Rayleigh on the Approximate Solution of certain Problems relating to the Potential: II.	195
Mr. J. Patterson on a Self-Recording Electrometer. (Plate VI.)	200
Messrs. H. G. J. Moseley and C. G. Darwin on the Reflexion of the X-rays	210
Notices respecting New Books:—	
Results of Observations made at the Coast and Geodetic Survey Magnetic Observatory near Tucson, Arizona. . .	232

NUMBER CLII.—AUGUST.

Prof. H. A. Bumstead on the Velocities of Delta Rays	233
Prof. L. T. More and Mr. S. J. Mauchly on the Action of a Magnetic Field upon the Electric Discharge through Gases. .	252
Mr. H. J. E. Beth on the Oscillations about a Position of Equilibrium where a Simple Linear Relation exists between the Frequencies of the Principal Vibrations. (Plates VII. & VIII.)	268
Prof. E. Rutherford and Mr. H. Richardson: Analysis of the γ Rays from Radium D and Radium E	324

	Page
Dr. G. N. Antonoff on the Existence of Uranium Y	332
Prof. W. G. Duffield on the Deposit upon the Poles of Metallic Arcs. (Plates IX. & X.)	333
Prof. O. W. Richardson on the Emission of Electrons from Tungsten at High Temperatures: an Experimental Proof that the Electric Current in Metals is carried by Electrons.	345
Prof. A. Anderson on Electric Currents through Air Films	351
Messrs. E. Marsden and R. H. Wilson: Some Experiments with the Active Deposit of Thorium	354
Mr. G. H. Livens on Magneto-Optical Rotativity	362
Messrs. F. S. Bryson and J. Logie on the Constitution of the Mercury Green Line ($\lambda=5461 \text{ \AA.U.}$)	366
Dr. K. Bergwitz: Remarks on the Note of Mr. W. A. D. Rudge, "On the Electrification of the Atmosphere and Surface of the Earth"	375
Proceedings of the Geological Society:—	
Mr. M. Odling on the Bathonian Rocks of the Oxford District	376
Mr. J. A. Thomson on the Petrology of the Kalgoorlie Goldfield (Western Australia)	377
Mr. P. G. H. Boswell on the Age of the Suffolk Valleys; with Notes on the Buried Channels of Drift	379
Mr. A. Jowett on the Volcanic Rocks in the Forfarshire Coast and their Associated Sediments	380

NUMBER CLIII.—SEPTEMBER.

Mr. H. P. Walmsley on the Distribution of the Active Deposit of Actinium in Electric Fields	381
Dr. T. S. Taylor on the Range and Ionization of the Alpha Particle in Simple Gases	402
Dr. B. Hodgson and Mr. P. A. Mainstone on Heating Effects at the Cathode in Vacuum Tubes	411
Mr. P. G. Nutting on the Absorption of Light in Heterogeneous Media	423
Mr. J. Hollingworth on a Physical Interpretation of the Bessel Function of Zero Order	427
Mr. J. R. Wilton on Plane Waves of Sound	440
Prof. O. W. Richardson on the Ions from Hot Salts	452
Prof. H. L. Cooke and O. W. Richardson on the Absorption of Heat produced by the Emission of Ions from Hot Bodies: II.	472
Dr. N. Bohr on the Constitution of Atoms and Molecules	476
Mr. R. V. Southwell on the Collapse of Tubes by External Pressure: II.	502
Prof. E. M. Wellisch and Dr. J. W. Woodrow: Experiments on Columnar Ionization	511

	Page
Mr. A. Fleck on the Disintegration of Uranium X.	528
Mr. G. H. Livens on the Intrinsic Optical Rotativity of Solutions	535
Dr. J. A. Gray: Notes on β and γ Rays	540
Notices respecting New Books:—	
Prof. J. Perry's Elementary Practical Mathematics	544
The Collected Mathematical Papers of J. J. Sylvester. Vol. IV.	545
Dr. F. A. Tarleton's Introduction to the Mathematical Theory of Attraction	546
Prof. G. W. Patterson's Revolving Vectors with special Application to Alternating Current Phenomena	546
Dr. A. A. Robb's Optical Geometry of Motion: a new View of the Theory of Relativity	547
Dr. G. A. Schott's Electromagnetic Radiation and the Mechanical Reactions arising from it.	547
Proceedings of the Geological Society:—	
Mr. J. Parkinson on a Group of Metamorphosed Sediments situated between Machakos and Lake Magadi in British East Africa	548

NUMBER CLIV.—OCTOBER.

Mr. K. T. Compton and Prof. O. W. Richardson on the Photoelectric Effect.—II.	549
Prof. E. H. Barton and Mr. W. B. Kilby on the Effect of Ionization of Air on Electrical Oscillations and its bearing on Long-Distance Wireless Telegraphy. (Plate XI.) . . .	567
Dr. H. Bateman on Corpuscular Radiation	579
Mr. A. B. Wood on the Range of the Recoil Atoms from Thorium C and Actinium C	586
Mr. I. Williams on the Absolute Thermal Conductivity of Glass	598
Mr. L. V. King on the Gradient of the Penetrating Radiation from the Earth.	604
Dr. J. A. Gray on the Scattering and Absorption of the γ Rays of Radium	611
Prof. E. M. Wellisch on the Distribution of the Active Deposit of Radium in an Electric Field.—II.	623
Prof. S. B. McLaren on a Theory of Gravity	636
Mr. A. L. Fletcher on a Method for the Determination of Radium in Radioactive Substances.	674
Dr. W. F. G. Swann on a Case of Anomalous Conduction in a Solid Dielectric.	678
Mr. J. R. Boon on the Effect of Pressure on the Electric Wind from a Discharging Point	694

	Page
Prof. E. Rutherford and Mr. J. M. Nuttall on the Scattering of α Particles by Gases	702
Mr. H. B. Keene on the Transmission of X Rays through Metals	712
Prof. E. Rutherford and Mr. H. Robinson on the Analysis of the β Rays from Radium B and Radium C. (Plate XII.)	717
Prof. J. S. Townsend on Low Potential Discharges in High Vacua	730
Dr. H. Wilde on some new Multiple Relations of the Atomic Weights of Elementary Substances; and on the Classification and Transformations of Neon and Helium	732
Prof. J. C. McLennan and Mr. A. R. McLeod: Measurements on the Earth's Penetrating Radiation with a Wulf Electrometer.....	740
Mr. W. A. Jenkins on a New Method of Determining the Horizontal Intensity of the Earth's Magnetic Field.....	752
Dr. Norman Campbell on the Velocity of δ Rays.....	774
Lord Rayleigh on the Motion of a Viscous Fluid.....	776
Prof. H. L. Callendar on Radiation and Specific Heat.....	787
Sir J. J. Thomson on the Structure of the Atom.....	792
Intelligence and Miscellaneous Articles:—	
Electrification of the Atmosphere and Surface of the Earth, by W. A. Douglas Rudge	800
The Magnetron and Planck's Universal Constant, by S. B. McLaren	800

NUMBER CLV.—NOVEMBER.

Mr. H. L. P. Jolly on the Distribution of Energy in the Spectra of Gases. (Plates XIII. & XIV.)	801
Prof. R. W. Wood on Resonance Spectra of Iodine under High Dispersion. (Plates XV. & XVI.)	828
Prof. R. W. Wood on the Polarization of the Light of Resonance Spectra. (Plate XVII.)	846
Prof. A. Righi: New Experiments on the Virtual Anode in the Tubes for Magnetic Rays	848
Dr. N. Bohr on the Constitution of Atoms and Molecules ..	857
Prof. J. C. McLennan and Mr. D. A. Keys on the Electrical Conductivity imparted to Liquid Air by Alpha Rays. (Plate XVIII.).....	876
Dr. I. J. Schwatt on the Summation of a Type of a Family of Trigonometric Series	895
Dr. I. J. Schwatt on a Method for the Summation of a Type of Infinite Series	898
Dr. F. Horton on Low Potential Discharges in High Vacua.	902
Mr. C. D. Child on the Line Spectrum from Uncharged Molecules	906

	Page
Dr. Norman Campbell on a Special Case of Gaseous Conduction	912
Mr. A. Ferguson on the Forces acting on a Solid Sphere in contact with a Liquid Surface	925
Notices respecting New Books:—	
Dr. L. Silberstein's Vectorial Mechanics	935
Bulletin of the Bureau of Standards	936

NUMBER CLVI.—DECEMBER.

Prof. E. Rutherford and Mr. H. Richardson: Analysis of the γ Rays of the Thorium and Actinium Products. (Plate XIX.)	937
Messrs. E. Marsden and A. B. Wood on a Method for the Determination of the Molecular Weights of the Radioactive Emanations with Application to Actinium Emanation	948
Prof. A. H. Gibson on the Motion of Long Air-bubbles in a Vertical Tube. (Plate XX.)	952
Mr. R. W. Lawson on the Spectra of High-Frequency Discharges in Geissler Tubes. (Plates XXI. & XXII.)	966
Mr. R. Rossi on Series of Lines in the Spectrum of Neon ..	981
Mr. J. W. Stewart on a New Solution to an Historical Theorem in Geometry	984
Prof. S. J. Barnett on some Experiments on the Magnetic Field of two Electromagnets in Rotation	987
Mr. H. Ogden on the Recombination of Ions made by α Rays	991
Lord Rayleigh on the Stability of the Laminar Motion of an Inviscid Fluid	1001
Prof. A. W. Conway on an Electromagnetic Hypothesis as to the Origin of Series Spectra	1010
Dr. R. Pohl and Dr. P. Pringsheim on the Long-wave Limits of the Normal Photoelectric Effect	1017
Mr. H. G. J. Moseley on the High-Frequency Spectra of the Elements. (Plate XXIII.)	1024
Mr. F. W. Wheatley on the Ionization of Gases by Collision with Low Electric Forces. (Plate XXIV.)	1034
Sir J. J. Thomson on the Structure of the Atom	1044
Dr. Norman Campbell on the Electrical Resistance of Mixtures of Xylol and Alcohol	1044
Mr. J. R. Wilton on the Highest Wave in Deep Water ..	1053
Intelligence and Miscellaneous Articles:—	
On the Existence of Uranium Y, by G. N. Antonoff..	1058
Index	1059

P L A T E S.

- I. & II. Illustrative of Dr. A. C. Crehore's Paper on the Formation of the Molecules of the Elements and their Compounds.
- III. Illustrative of Messrs. R. M. Deeley and P. H. Parr's Paper on the Viscosity of Glacier Ice.
- IV. Illustrative of Prof. R. W. Wood's Paper on the Use of the Interferometer for the Study of Band Spectra.
- V. Illustrative of Mr. A. N. Shaw's Paper on Interference Phenomena with Gamma Rays.
- VI. Illustrative of Mr. J. Patterson's Paper on a Self-Recording Electrometer.
- VII. & VIII. Illustrative of Mr. H. J. E. Beth's Paper on the Oscillations about a Position of Equilibrium where a Simple Linear Relation exists between the Frequencies of the Principal Vibrations.
- IX. & X. Illustrative of Prof. W. G. Duffield's Paper on the Deposit upon the Poles of Metallic Arcs.
- XI. Illustrative of Prof. E. H. Barton and Mr. W. B. Kilby's Paper on the Effect of Ionization of Air on Electrical Oscillations and its bearing on Long-Distance Wireless Telegraphy.
- XII. Illustrative of Prof. E. Rutherford and Mr. H. Robinson's Paper on the Analysis of the β Rays from Radium B and Radium C.
- XIII. & XIV. Illustrative of Mr. H. L. P. Jolly's Paper on the Distribution of Energy in the Spectra of Gases.
- XV. & XVI. Illustrative of Prof. R. W. Wood's Paper on Resonance Spectra of Iodine under High Dispersion.
- XVII. Illustrative of Prof. R. W. Wood's Paper on the Polarization of the Light of Resonance Spectra.
- XVIII. Illustrative of Prof. J. C. McLennan and Mr. D. A. Keys's Paper on the Electrical Conductivity imparted to Liquid Air by Alpha Rays.
- XIX. Illustrative of Prof. E. Rutherford and Mr. H. Richardson's Paper on the γ Rays of the Thorium and Actinium Products.
- XX. Illustrative of Prof. A. H. Gibson's Paper on the Motion of Long Air-bubbles in a Vertical Tube.
- XXI. & XXII. Illustrative of Mr. R. W. Lawson's Paper on the Spectra of High-Frequency Discharges in Geissler Tubes.
- XXIII. Illustrative of Mr. H. G. J. Moseley's Paper on the High-Frequency Spectra of the Elements.
- XXIV. Illustrative of Mr. F. W. Wheatley's Paper on the Ionization of Gases by Collision with Low Electric Forces.

THE
LONDON, EDINBURGH, AND DUBLIN
PHILOSOPHICAL MAGAZINE
AND
JOURNAL OF SCIENCE.

[SIXTH SERIES.]

JULY 1913.

I. *On the Constitution of Atoms and Molecules.*
By N. BOHR, *Dr. phil. Copenhagen* *.

Introduction.

IN order to explain the results of experiments on scattering of α rays by matter Prof. Rutherford† has given a theory of the structure of atoms. According to this theory, the atoms consist of a positively charged nucleus surrounded by a system of electrons kept together by attractive forces from the nucleus; the total negative charge of the electrons is equal to the positive charge of the nucleus. Further, the nucleus is assumed to be the seat of the essential part of the mass of the atom, and to have linear dimensions exceedingly small compared with the linear dimensions of the whole atom. The number of electrons in an atom is deduced to be approximately equal to half the atomic weight. Great interest is to be attributed to this atom-model; for, as Rutherford has shown, the assumption of the existence of nuclei, as those in question, seems to be necessary in order to account for the results of the experiments on large angle scattering of the α rays‡.

In an attempt to explain some of the properties of matter on the basis of this atom-model we meet, however, with difficulties of a serious nature arising from the apparent

* Communicated by Prof. E. Rutherford, F.R.S.

† E. Rutherford, *Phil. Mag.* xxi. p. 669 (1911).

‡ See also Geiger and Marsden, *Phil. Mag.* April 1913.

instability of the system of electrons: difficulties purposely avoided in atom-models previously considered, for instance, in the one proposed by Sir J. J. Thomson*. According to the theory of the latter the atom consists of a sphere of uniform positive electrification, inside which the electrons move in circular orbits.

The principal difference between the atom-models proposed by Thomson and Rutherford consists in the circumstance that the forces acting on the electrons in the atom-model of Thomson allow of certain configurations and motions of the electrons for which the system is in a stable equilibrium; such configurations, however, apparently do not exist for the second atom-model. The nature of the difference in question will perhaps be most clearly seen by noticing that among the quantities characterizing the first atom a quantity appears—the radius of the positive sphere—of dimensions of a length and of the same order of magnitude as the linear extension of the atom, while such a length does not appear among the quantities characterizing the second atom, viz. the charges and masses of the electrons and the positive nucleus; nor can it be determined solely by help of the latter quantities.

The way of considering a problem of this kind has, however, undergone essential alterations in recent years owing to the development of the theory of the energy radiation, and the direct affirmation of the new assumptions introduced in this theory, found by experiments on very different phenomena such as specific heats, photoelectric effect, Röntgen-rays, &c. The result of the discussion of these questions seems to be a general acknowledgment of the inadequacy of the classical electrodynamics in describing the behaviour of systems of atomic size†. Whatever the alteration in the laws of motion of the electrons may be, it seems necessary to introduce in the laws in question a quantity foreign to the classical electrodynamics, *i. e.* Planck's constant, or as it often is called the elementary quantum of action. By the introduction of this quantity the question of the stable configuration of the electrons in the atoms is essentially changed, as this constant is of such dimensions and magnitude that it, together with the mass and charge of the particles, can determine a length of the order of magnitude required.

This paper is an attempt to show that the application of the above ideas to Rutherford's atom-model affords a basis

* J. J. Thomson, *Phil. Mag.* vii. p. 237 (1904).

† See *f. inst.*, 'Théorie du rayonnement et les quanta.' *Rapports de la réunion à Bruxelles*, Nov. 1911. Paris, 1912.

for a theory of the constitution of atoms. It will further be shown that from this theory we are led to a theory of the constitution of molecules.

In the present first part of the paper the mechanism of the binding of electrons by a positive nucleus is discussed in relation to Planck's theory. It will be shown that it is possible from the point of view taken to account in a simple way for the law of the line spectrum of hydrogen. Further, reasons are given for a principal hypothesis on which the considerations contained in the following parts are based.

I wish here to express my thanks to Prof. Rutherford for his kind and encouraging interest in this work.

PART I.—BINDING OF ELECTRONS BY POSITIVE NUCLEI.

§ 1. *General Considerations.*

The inadequacy of the classical electrodynamics in accounting for the properties of atoms from an atom-model as Rutherford's, will appear very clearly if we consider a simple system consisting of a positively charged nucleus of very small dimensions and an electron describing closed orbits around it. For simplicity, let us assume that the mass of the electron is negligibly small in comparison with that of the nucleus, and further, that the velocity of the electron is small compared with that of light.

Let us at first assume that there is no energy radiation. In this case the electron will describe stationary elliptical orbits. The frequency of revolution ω and the major-axis of the orbit $2a$ will depend on the amount of energy W which must be transferred to the system in order to remove the electron to an infinitely great distance apart from the nucleus. Denoting the charge of the electron and of the nucleus by $-e$ and E respectively and the mass of the electron by m , we thus get

$$\omega = \frac{\sqrt{2}}{\pi} \frac{W^{\frac{3}{2}}}{eE\sqrt{m}}, \quad 2a = \frac{eE}{W}. \quad \dots \quad (1)$$

Further, it can easily be shown that the mean value of the kinetic energy of the electron taken for a whole revolution is equal to W . We see that if the value of W is not given, there will be no values of ω and a characteristic for the system in question.

Let us now, however, take the effect of the energy radiation into account, calculated in the ordinary way from the acceleration of the electron. In this case the electron will

no longer describe stationary orbits. W will continuously increase, and the electron will approach the nucleus describing orbits of smaller and smaller dimensions, and with greater and greater frequency; the electron on the average gaining in kinetic energy at the same time as the whole system loses energy. This process will go on until the dimensions of the orbit are of the same order of magnitude as the dimensions of the electron or those of the nucleus. A simple calculation shows that the energy radiated out during the process considered will be enormously great compared with that radiated out by ordinary molecular processes.

It is obvious that the behaviour of such a system will be very different from that of an atomic system occurring in nature. In the first place, the actual atoms in their permanent state seem to have absolutely fixed dimensions and frequencies. Further, if we consider any molecular process, the result seems always to be that after a certain amount of energy characteristic for the systems in question is radiated out, the systems will again settle down in a stable state of equilibrium, in which the distances apart of the particles are of the same order of magnitude as before the process.

Now the essential point in Planck's theory of radiation is that the energy radiation from an atomic system does not take place in the continuous way assumed in the ordinary electrodynamics, but that it, on the contrary, takes place in distinctly separated emissions, the amount of energy radiated out from an atomic vibrator of frequency ν in a single emission being equal to $\tau h\nu$, where τ is an entire number, and h is a universal constant*.

Returning to the simple case of an electron and a positive nucleus considered above, let us assume that the electron at the beginning of the interaction with the nucleus was at a great distance apart from the nucleus, and had no sensible velocity relative to the latter. Let us further assume that the electron after the interaction has taken place has settled down in a stationary orbit around the nucleus. We shall, for reasons referred to later, assume that the orbit in question is circular; this assumption will, however, make no alteration in the calculations for systems containing only a single electron.

Let us now assume that, during the binding of the electron, a homogeneous radiation is emitted of a frequency ν , equal to half the frequency of revolution of the electron in its final

* See f. inst., M. Planck, *Ann. d. Phys.* xxxi. p. 758 (1910); xxxvii. p. 642 (1912); *Verh. deutsch. Phys. Ges.* 1911, p. 138.

orbit ; then, from Planck's theory, we might expect that the amount of energy emitted by the process considered is equal to $\tau h\nu$, where h is Planck's constant and τ an entire number. If we assume that the radiation emitted is homogeneous, the second assumption concerning the frequency of the radiation suggests itself, since the frequency of revolution of the electron at the beginning of the emission is 0. The question, however, of the rigorous validity of both assumptions, and also of the application made of Planck's theory, will be more closely discussed in § 3.

Putting
$$W = \tau h \frac{\omega}{2}, \quad (2)$$

we get by help of the formula (1)

$$W = \frac{2\pi^2 m e^3 E^2}{\tau^2 h^2}, \quad \omega = \frac{4\pi^2 m e^2 E^2}{\tau^3 h^3}, \quad 2a = \frac{\tau^2 h^2}{2\pi^2 m e E} . . . (3)$$

If in these expressions we give τ different values, we get a series of values for W , ω , and a corresponding to a series of configurations of the system. According to the above considerations, we are led to assume that these configurations will correspond to states of the system in which there is no radiation of energy; states which consequently will be stationary as long as the system is not disturbed from outside. We see that the value of W is greatest if τ has its smallest value 1. This case will therefore correspond to the most stable state of the system, *i. e.* will correspond to the binding of the electron for the breaking up of which the greatest amount of energy is required.

Putting in the above expressions $\tau=1$ and $E=e$, and introducing the experimental values

$$e = 4.7 \cdot 10^{-10}, \quad \frac{e}{m} = 5.31 \cdot 10^{17}, \quad h = 6.5 \cdot 10^{-27},$$

we get

$$2a = 1.1 \cdot 10^{-8} \text{ cm.}, \quad \omega = 6.2 \cdot 10^{15} \frac{1}{\text{sec.}}, \quad \frac{W}{e} = 13 \text{ volt.}$$

We see that these values are of the same order of magnitude as the linear dimensions of the atoms, the optical frequencies, and the ionization-potentials.

The general importance of Planck's theory for the discussion of the behaviour of atomic systems was originally pointed out by Einstein*. The considerations of Einstein

* A. Einstein, *Ann. d. Phys.* xvii. p. 132 (1905); xx. p. 199 (1906); xxii. p. 180 (1907).

have been developed and applied on a number of different phenomena, especially by Stark, Nernst, and Sommerfeld. The agreement as to the order of magnitude between values observed for the frequencies and dimensions of the atoms, and values for these quantities calculated by considerations similar to those given above, has been the subject of much discussion. It was first pointed out by Haas*, in an attempt to explain the meaning and the value of Planck's constant on the basis of J. J. Thomson's atom-model, by help of the linear dimensions and frequency of an hydrogen atom.

Systems of the kind considered in this paper, in which the forces between the particles vary inversely as the square of the distance, are discussed in relation to Planck's theory by J. W. Nicholson †. In a series of papers this author has shown that it seems to be possible to account for lines of hitherto unknown origin in the spectra of the stellar nebulae and that of the solar corona, by assuming the presence in these bodies of certain hypothetical elements of exactly indicated constitution. The atoms of these elements are supposed to consist simply of a ring of a few electrons surrounding a positive nucleus of negligibly small dimensions. The ratios between the frequencies corresponding to the lines in question are compared with the ratios between the frequencies corresponding to different modes of vibration of the ring of electrons. Nicholson has obtained a relation to Planck's theory showing that the ratios between the wave-length of different sets of lines of the coronal spectrum can be accounted for with great accuracy by assuming that the ratio between the energy of the system and the frequency of rotation of the ring is equal to an entire multiple of Planck's constant. The quantity Nicholson refers to as the energy is equal to twice the quantity which we have denoted above by W . In the latest paper cited Nicholson has found it necessary to give the theory a more complicated form, still, however, representing the ratio of energy to frequency by a simple function of whole numbers.

The excellent agreement between the calculated and observed values of the ratios between the wave-lengths in question seems a strong argument in favour of the validity of the foundation of Nicholson's calculations. Serious

* A. E. Haas, *Jahrb. d. Rad. u. El.* vii. p. 261 (1910). See further, A. Schidlof, *Ann. d. Phys.* xxxv. p. 90 (1911); E. Wertheimer, *Phys. Zeitschr.* xii. p. 409 (1911), *Verh. deutsch. Phys. Ges.* 1912, p. 431; F. A. Lindemann, *Verh. deutsch. Phys. Ges.* 1911, pp. 482, 1107; F. Haber, *Verh. deutsch. Phys. Ges.* 1911, p. 1117.

† J. W. Nicholson, *Month. Not. Roy. Astr. Soc.* lxxii. pp. 49, 139, 677, 693, 729 (1912).

objections, however, may be raised against the theory. These objections are intimately connected with the problem of the homogeneity of the radiation emitted. In Nicholson's calculations the frequency of lines in a line-spectrum is identified with the frequency of vibration of a mechanical system in a distinctly indicated state of equilibrium. As a relation from Planck's theory is used, we might expect that the radiation is sent out in quanta; but systems like those considered, in which the frequency is a function of the energy, cannot emit a finite amount of a homogeneous radiation; for, as soon as the emission of radiation is started, the energy and also the frequency of the system are altered. Further, according to the calculation of Nicholson, the systems are unstable for some modes of vibration. Apart from such objections—which may be only formal (see p. 23)—it must be remarked, that the theory in the form given does not seem to be able to account for the well-known laws of Balmer and Rydberg connecting the frequencies of the lines in the line-spectra of the ordinary elements.

It will now be attempted to show that the difficulties in question disappear if we consider the problems from the point of view taken in this paper. Before proceeding it may be useful to restate briefly the ideas characterizing the calculations on p. 5. The principal assumptions used are :

- (1) That the dynamical equilibrium of the systems in the stationary states can be discussed by help of the ordinary mechanics, while the passing of the systems between different stationary states cannot be treated on that basis.
- (2) That the latter process is followed by the emission of a *homogeneous* radiation, for which the relation between the frequency and the amount of energy emitted is the one given by Planck's theory.

The first assumption seems to present itself; for it is known that the ordinary mechanics cannot have an absolute validity, but will only hold in calculations of certain mean values of the motion of the electrons. On the other hand, in the calculations of the dynamical equilibrium in a stationary state in which there is no relative displacement of the particles, we need not distinguish between the actual motions and their mean values. The second assumption is in obvious contrast to the ordinary ideas of electrodynamics, but appears to be necessary in order to account for experimental facts.

In the calculations on page 5 we have further made use

of the more special assumptions, viz. that the different stationary states correspond to the emission of a different number of Planck's energy-quanta, and that the frequency of the radiation emitted during the passing of the system from a state in which no energy is yet radiated out to one of the stationary states, is equal to half the frequency of revolution of the electron in the latter state. We can, however (see § 3), also arrive at the expressions (3) for the stationary states by using assumptions of somewhat different form. We shall, therefore, postpone the discussion of the special assumptions, and first show how by the help of the above principal assumptions, and of the expressions (3) for the stationary states, we can account for the line-spectrum of hydrogen.

§ 2. Emission of Line-spectra.

Spectrum of Hydrogen.—General evidence indicates that an atom of hydrogen consists simply of a single electron rotating round a positive nucleus of charge e^* . The re-formation of a hydrogen atom, when the electron has been removed to great distances away from the nucleus—*e. g.* by the effect of electrical discharge in a vacuum tube—will accordingly correspond to the binding of an electron by a positive nucleus considered on p. 5. If in (3) we put $E=e$, we get for the total amount of energy radiated out by the formation of one of the stationary states,

$$W_{\tau} = \frac{2\pi^2 m e^4}{h^2 \tau^2}.$$

The amount of energy emitted by the passing of the system from a state corresponding to $\tau = \tau_1$ to one corresponding to $\tau = \tau_2$, is consequently

$$W_{\tau_2} - W_{\tau_1} = \frac{2\pi^2 m e^4}{h^2} \left(\frac{1}{\tau_2^2} - \frac{1}{\tau_1^2} \right).$$

If now we suppose that the radiation in question is homogeneous, and that the amount of energy emitted is equal to $h\nu$, where ν is the frequency of the radiation, we get

$$W_{\tau_2} - W_{\tau_1} = h\nu,$$

* See *f. inst.* N. Bohr, *Phil. Mag.* xxv. p. 24 (1913). The conclusion drawn in the paper cited is strongly supported by the fact that hydrogen, in the experiments on positive rays of Sir J. J. Thomson, is the only element which never occurs with a positive charge corresponding to the loss of more than one electron (*comp. Phil. Mag.* xxiv. p. 672 (1912)).

and from this

$$\nu = \frac{2\pi^2 m e^4}{h^3} \left(\frac{1}{\tau_2^2} - \frac{1}{\tau_1^2} \right) \dots \dots \dots (4)$$

We see that this expression accounts for the law connecting the lines in the spectrum of hydrogen. If we put $\tau_2=2$ and let τ_1 vary, we get the ordinary Balmer series. If we put $\tau_2=3$, we get the series in the ultra-red observed by Paschen* and previously suspected by Ritz. If we put $\tau_2=1$ and $\tau_1=4, 5, \dots$, we get series respectively in the extreme ultra-violet and the extreme ultra-red, which are not observed, but the existence of which may be expected.

The agreement in question is quantitative as well as qualitative. Putting

$$e=4.7 \cdot 10^{-10}, \quad \frac{e}{m} = 5.31 \cdot 10^{17}, \quad \text{and} \quad h=6.5 \cdot 10^{-27},$$

we get

$$\frac{2\pi^2 m e^4}{h^3} = 3.1 \cdot 10^{15}.$$

The observed value for the factor outside the bracket in the formula (4) is

$$3.290 \cdot 10^{15}.$$

The agreement between the theoretical and observed values is inside the uncertainty due to experimental errors in the constants entering in the expression for the theoretical value. We shall in § 3 return to consider the possible importance of the agreement in question.

It may be remarked that the fact, that it has not been possible to observe more than 12 lines of the Balmer series in experiments with vacuum tubes, while 33 lines are observed in the spectra of some celestial bodies, is just what we should expect from the above theory. According to the equation (3) the diameter of the orbit of the electron in the different stationary states is proportional to τ^2 . For $\tau=12$ the diameter is equal to $1.6 \cdot 10^{-6}$ cm., or equal to the mean distance between the molecules in a gas at a pressure of about 7 mm. mercury; for $\tau=33$ the diameter is equal to $1.2 \cdot 10^{-5}$ cm., corresponding to the mean distance of the molecules at a pressure of about 0.02 mm. mercury. According to the theory the necessary condition for the appearance of a great number of lines is therefore a very small density of the gas; for simultaneously to obtain an

* F. Paschen, *Ann. d. Phys.* xxvii. p. 565 (1908).

intensity sufficient for observation the space filled with the gas must be very great. If the theory is right, we may therefore never expect to be able in experiments with vacuum tubes to observe the lines corresponding to high numbers of the Balmer series of the emission spectrum of hydrogen; it might, however, be possible to observe the lines by investigation of the absorption spectrum of this gas (see § 4).

It will be observed that we in the above way do not obtain other series of lines, generally ascribed to hydrogen; for instance, the series first observed by Pickering* in the spectrum of the star ζ Puppis, and the set of series recently found by Fowler† by experiments with vacuum tubes containing a mixture of hydrogen and helium. We shall, however, see that, by help of the above theory, we can account naturally for these series of lines if we ascribe them to helium.

A neutral atom of the latter element consists, according to Rutherford's theory, of a positive nucleus of charge $2e$ and two electrons. Now considering the binding of a single electron by a helium nucleus, we get, putting $E=2e$ in the expressions (3) on page 5, and proceeding in exactly the same way as above,

$$\nu = \frac{8\pi^2 m e^4}{h^3} \left(\frac{1}{\tau_2^2} - \frac{1}{\tau_1^2} \right) = \frac{2\pi^2 m e^4}{h^3} \left(\frac{1}{\left(\frac{\tau_2}{2}\right)^2} - \frac{1}{\left(\frac{\tau_1}{2}\right)^2} \right).$$

If we in this formula put $\tau_2=1$ or $\tau_2=2$, we get series of lines in the extreme ultra-violet. If we put $\tau_2=3$, and let τ_1 vary, we get a series which includes 2 of the series observed by Fowler, and denoted by him as the first and second principal series of the hydrogen spectrum. If we put $\tau_2=4$, we get the series observed by Pickering in the spectrum of ζ Puppis. Every second of the lines in this series is identical with a line in the Balmer series of the hydrogen spectrum; the presence of hydrogen in the star in question may therefore account for the fact that these lines are of a greater intensity than the rest of the lines in the series. The series is also observed in the experiments of Fowler, and denoted in his paper as the Sharp series of the hydrogen spectrum. If we finally in the above formula put $\tau_2=5, 6, \dots$, we get series, the strong lines of which are to be expected in the ultra-red.

The reason why the spectrum considered is not observed in

* E. C. Pickering, *Astrophys. J.* iv. p. 369 (1896); v. p. 92 (1897).

† A. Fowler, *Month. Not. Roy. Astr. Soc.* lxxiii. Dec. 1912.

ordinary helium tubes may be that in such tubes the ionization of helium is not so complete as in the star considered or in the experiments of Fowler, where a strong discharge was sent through a mixture of hydrogen and helium. The condition for the appearance of the spectrum is, according to the above theory, that helium atoms are present in a state in which they have lost both their electrons. Now we must assume that the amount of energy to be used in removing the second electron from a helium atom is much greater than that to be used in removing the first. Further, it is known from experiments on positive rays, that hydrogen atoms can acquire a negative charge; therefore the presence of hydrogen in the experiments of Fowler may effect that more electrons are removed from some of the helium atoms than would be the case if only helium were present.

Spectra of other substances.—In case of systems containing more electrons we must—in conformity with the result of experiments—expect more complicated laws for the line-spectra than those considered. I shall try to show that the point of view taken above allows, at any rate, a certain understanding of the laws observed.

According to Rydberg's theory—with the generalization given by Ritz*—the frequency corresponding to the lines of the spectrum of an element can be expressed by

$$\nu = F_r(\tau_1) - F_s(\tau_2),$$

where τ_1 and τ_2 are entire numbers, and F_1, F_2, F_3, \dots are functions of τ which approximately are equal to $\frac{K}{(\tau + a_1)^2}, \frac{K}{(\tau + a_2)^2}, \dots$ K is a universal constant, equal to the factor outside the bracket in the formula (4) for the spectrum of hydrogen. The different series appear if we put τ_1 or τ_2 equal to a fixed number and let the other vary.

The circumstance that the frequency can be written as a difference between two functions of entire numbers suggests an origin of the lines in the spectra in question similar to the one we have assumed for hydrogen; *i. e.* that the lines correspond to a radiation emitted during the passing of the system between two different stationary states. For systems containing more than one electron the detailed discussion may be very complicated, as there will be many different configurations of the electrons which can be taken into consideration as stationary states. This may account for the different sets of series in the line spectra emitted from the

* W. Ritz, *Phys. Zeitschr.* ix. p. 521 (1908).

substances in question. Here I shall only try to show how, by help of the theory, it can be simply explained that the constant K entering in Rydberg's formula is the same for all substances.

Let us assume that the spectrum in question corresponds to the radiation emitted during the binding of an electron; and let us further assume that the system including the electron considered is neutral. The force on the electron, when at a great distance apart from the nucleus and the electrons previously bound, will be very nearly the same as in the above case of the binding of an electron by a hydrogen nucleus. The energy corresponding to one of the stationary states will therefore for τ great be very nearly equal to that given by the expression (3) on p. 5, if we put $E=e$. For τ great we consequently get

$$\lim (\tau^2 \cdot F_1(\tau)) = \lim (\tau^2 \cdot F_2(\tau)) = \dots = \frac{2\pi^2 m e^4}{h^3},$$

in conformity with Rydberg's theory.

§ 3. General Considerations continued.

We shall now return to the discussion (see p. 7) of the special assumptions used in deducing the expressions (3) on p. 5 for the stationary states of a system consisting of an electron rotating round a nucleus.

For one, we have assumed that the different stationary states correspond to an emission of a different number of energy-quanta. Considering systems in which the frequency is a function of the energy, this assumption, however, may be regarded as improbable; for as soon as one quantum is sent out the frequency is altered. We shall now see that we can leave the assumption used and still retain the equation (2) on p. 5, and thereby the formal analogy with Planck's theory.

Firstly, it will be observed that it has not been necessary, in order to account for the law of the spectra by help of the expressions (3) for the stationary states, to assume that in any case a radiation is sent out corresponding to more than a single energy-quantum, $h\nu$. Further information on the frequency of the radiation may be obtained by comparing calculations of the energy radiation in the region of slow vibrations based on the above assumptions with calculations based on the ordinary mechanics. As is known, calculations on the latter basis are in agreement with experiments on the energy radiation in the named region.

Let us assume that the ratio between the total amount of

energy emitted and the frequency of revolution of the electron for the different stationary states is given by the equation $W = f(\tau) \cdot h\omega$, instead of by the equation (2). Proceeding in the same way as above, we get in this case instead of (3)

$$W = \frac{\pi^2 m e^2 E^2}{2h^2 f^2(\tau)}, \quad \omega = \frac{\pi^2 m e^2 E^2}{2h^3 f^3(\tau)}.$$

Assuming as above that the amount of energy emitted during the passing of the system from a state corresponding to $\tau = \tau_1$ to one for which $\tau = \tau_2$ is equal to $h\nu$, we get instead of (4)

$$\nu = \frac{\pi^2 m e^2 E^2}{2h^3} \left(\frac{1}{f^2(\tau_2)} - \frac{1}{f^2(\tau_1)} \right).$$

We see that in order to get an expression of the same form as the Balmer series we must put $f(\tau) = c\tau$.

In order to determine c let us now consider the passing of the system between two successive stationary states corresponding to $\tau = N$ and $\tau = N - 1$; introducing $f(\tau) = c\tau$, we get for the frequency of the radiation emitted

$$\nu = \frac{\pi^2 m e^2 E^2}{2c^2 h^3} \cdot \frac{2N - 1}{N^2(N - 1)^2}.$$

For the frequency of revolution of the electron before and after the emission we have

$$\omega_N = \frac{\pi^2 m e^2 E^2}{2c^3 h^3 N^3} \quad \text{and} \quad \omega_{N-1} = \frac{\pi^2 m e^2 E^2}{2c^3 h^3 (N - 1)^3}.$$

If N is great the ratio between the frequency before and after the emission will be very near equal to 1; and according to the ordinary electrodynamics we should therefore expect that the ratio between the frequency of radiation and the frequency of revolution also is very nearly equal to 1. This condition will only be satisfied if $c = \frac{1}{2}$. Putting $f(\tau) = \frac{\tau}{2}$, we, however, again arrive at the equation (2) and consequently at the expression (3) for the stationary states.

If we consider the passing of the system between two states corresponding to $\tau = N$ and $\tau = N - n$, where n is small compared with N , we get with the same approximation as above, putting $f(\tau) = \frac{\tau}{2}$,

$$\nu = n\omega.$$

The possibility of an emission of a radiation of such a frequency may also be interpreted from analogy with the ordinary electrodynamics, as an electron rotating round a nucleus in an elliptical orbit will emit a radiation which according to Fourier's theorem can be resolved into homogeneous components, the frequencies of which are $n\omega$, if ω is the frequency of revolution of the electron.

We are thus led to assume that the interpretation of the equation (2) is not that the different stationary states correspond to an emission of different numbers of energy-quanta, but that the frequency of the energy emitted during the passing of the system from a state in which no energy is yet radiated out to one of the different stationary states, is equal to different multiples of $\frac{\omega}{2}$, where ω is the frequency of revolution of the electron in the state considered. From this assumption we get exactly the same expressions as before for the stationary states, and from these by help of the principal assumptions on p. 7 the same expression for the law of the hydrogen spectrum. Consequently we may regard our preliminary considerations on p. 5 only as a simple form of representing the results of the theory.

Before we leave the discussion of this question, we shall for a moment return to the question of the significance of the agreement between the observed and calculated values of the constant entering in the expressions (4) for the Balmer series of the hydrogen spectrum. From the above consideration it will follow that, taking the starting-point in the form of the law of the hydrogen spectrum and assuming that the different lines correspond to a homogeneous radiation emitted during the passing between different stationary states, we shall arrive at exactly the same expression for the constant in question as that given by (4), if we only assume (1) that the radiation is sent out in quanta $h\nu$, and (2) that the frequency of the radiation emitted during the passing of the system between successive stationary states will coincide with the frequency of revolution of the electron in the region of slow vibrations.

As all the assumptions used in this latter way of representing the theory are of what we may call a qualitative character, we are justified in expecting—if the whole way of considering is a sound one—an absolute agreement between the values calculated and observed for the constant in question, and not only an approximate agreement. The formula (4) may therefore be of value in the discussion of the results of experimental determinations of the constants e , m , and h .

While there obviously can be no question of a mechanical foundation of the calculations given in this paper, it is, however, possible to give a very simple interpretation of the result of the calculation on p. 5 by help of symbols taken from the ordinary mechanics. Denoting the angular momentum of the electron round the nucleus by M , we have immediately for a circular orbit $\pi M = \frac{T}{\omega}$, where ω is the frequency of revolution and T the kinetic energy of the electron; for a circular orbit we further have $T = W$ (see p. 3) and from (2), p. 5, we consequently get

$$M = \tau M_0,$$

where

$$M_0 = \frac{h}{2\pi} = 1.04 \times 10^{-27}.$$

If we therefore assume that the orbit of the electron in the stationary states is circular, the result of the calculation on p. 5 can be expressed by the simple condition: that the angular momentum of the electron round the nucleus in a stationary state of the system is equal to an entire multiple of a universal value, independent of the charge on the nucleus. The possible importance of the angular momentum in the discussion of atomic systems in relation to Planck's theory is emphasized by Nicholson*.

The great number of different stationary states we do not observe except by investigation of the emission and absorption of radiation. In most of the other physical phenomena, however, we only observe the atoms of the matter in a single distinct state, *i. e.* the state of the atoms at low temperature. From the preceding considerations we are immediately led to the assumption that the "permanent" state is the one among the stationary states during the formation of which the greatest amount of energy is emitted. According to the equation (3) on p. 5, this state is the one which corresponds to $\tau = 1$.

§ 4. Absorption of Radiation.

In order to account for Kirchhoff's law it is necessary to introduce assumptions on the mechanism of absorption of radiation which correspond to those we have used considering the emission. Thus we must assume that a system consisting of a nucleus and an electron rotating round it under certain circumstances can absorb a radiation of a frequency equal to the frequency of the homogeneous radiation emitted during

* J. W. Nicholson, *loc. cit.* p. 679.

the passing of the system between different stationary states. Let us consider the radiation emitted during the passing of the system between two stationary states A_1 and A_2 corresponding to values for τ equal to τ_1 and τ_2 , $\tau_1 > \tau_2$. As the necessary condition for an emission of the radiation in question was the presence of systems in the state A_1 , we must assume that the necessary condition for an absorption of the radiation is the presence of systems in the state A_2 .

These considerations seem to be in conformity with experiments on absorption in gases. In hydrogen gas at ordinary conditions for instance there is no absorption of a radiation of a frequency corresponding to the line-spectrum of this gas; such an absorption is only observed in hydrogen gas in a luminous state. This is what we should expect according to the above. We have on p. 9 assumed that the radiation in question was emitted during the passing of the systems between stationary states corresponding to $\tau \geq 2$. The state of the atoms in hydrogen gas at ordinary conditions should, however, correspond to $\tau=1$; furthermore, hydrogen atoms at ordinary conditions combine into molecules, *i. e.* into systems in which the electrons have frequencies different from those in the atoms (see Part III.). From the circumstance that certain substances in a non-luminous state, as, for instance, sodium vapour, absorb radiation corresponding to lines in the line-spectra of the substances, we may, on the other hand, conclude that the lines in question are emitted during the passing of the system between two states, one of which is the permanent state.

How much the above considerations differ from an interpretation based on the ordinary electrodynamics is perhaps most clearly shown by the fact that we have been forced to assume that a system of electrons will absorb a radiation of a frequency different from the frequency of vibration of the electrons calculated in the ordinary way. It may in this connexion be of interest to mention a generalization of the considerations to which we are led by experiments on the photo-electric effect, and which may be able to throw some light on the problem in question. Let us consider a state of the system in which the electron is free, *i. e.* in which the electron possesses kinetic energy sufficient to remove to infinite distances from the nucleus. If we assume that the motion of the electron is governed by the ordinary mechanics and that there is no (sensible) energy radiation, the total energy of the system—as in the above considered stationary states—will be constant. Further, there will be perfect continuity between the two kinds of states, as the difference between

frequency and dimensions of the systems in successive stationary states will diminish without limit if τ increases. In the following considerations we shall for the sake of brevity refer to the two kinds of states in question as "mechanical" states; by this notation only emphasizing the assumption that the motion of the electron in both cases can be accounted for by the ordinary mechanics.

Tracing the analogy between the two kinds of mechanical states, we might now expect the possibility of an absorption of radiation, not only corresponding to the passing of the system between two different stationary states, but also corresponding to the passing between one of the stationary states and a state in which the electron is free; and as above, we might expect that the frequency of this radiation was determined by the equation $E = h\nu$, where E is the difference between the total energy of the system in the two states. As it will be seen, such an absorption of radiation is just what is observed in experiments on ionization by ultra-violet light and by Röntgen rays. Obviously, we get in this way the same expression for the kinetic energy of an electron ejected from an atom by photo-electric effect as that deduced by Einstein *, *i. e.* $T = h\nu - W$, where T is the kinetic energy of the electron ejected, and W the total amount of energy emitted during the original binding of the electron.

The above considerations may further account for the result of some experiments of R. W. Wood † on absorption of light by sodium vapour. In these experiments, an absorption corresponding to a very great number of lines in the principal series of the sodium spectrum is observed, and in addition a continuous absorption which begins at the head of the series and extends to the extreme ultra-violet. This is exactly what we should expect according to the analogy in question, and, as we shall see, a closer consideration of the above experiments allows us to trace the analogy still further. As mentioned on p. 9 the radii of the orbits of the electrons will for stationary states corresponding to high values for τ be very great compared with ordinary atomic dimensions. This circumstance was used as an explanation of the non-appearance in experiments with vacuum-tubes of lines corresponding to the higher numbers in the Balmer series of the hydrogen spectrum. This is also in conformity with experiments on the emission spectrum of sodium; in the principal series of the emission spectrum of this substance

* A. Einstein, *Ann. d. Phys.* xvii, p. 146 (1905).

† R. W. Wood, *Physical Optics*, p. 513 (1911).

rather few lines are observed. Now in Wood's experiments the pressure was not very low, and the states corresponding to high values for τ could therefore not appear; yet in the absorption spectrum about 50 lines were detected. In the experiments in question we consequently observe an absorption of radiation which is not accompanied by a complete transition between two different stationary states. According to the present theory we must assume that this absorption is followed by an emission of energy during which the systems pass back to the original stationary state. If there are no collisions between the different systems this energy will be emitted as a radiation of the same frequency as that absorbed, and there will be no true absorption but only a scattering of the original radiation; a true absorption will not occur unless the energy in question is transformed by collisions into kinetic energy of free particles. In analogy we may now from the above experiments conclude that a bound electron—also in cases in which there is no ionization—will have an absorbing (scattering) influence on a homogeneous radiation, as soon as the frequency of the radiation is greater than W/h , where W is the total amount of energy emitted during the binding of the electron. This would be highly in favour of a theory of absorption as the one sketched above, as there can in such a case be no question of a coincidence of the frequency of the radiation and a characteristic frequency of vibration of the electron. It will further be seen that the assumption, that there will be an absorption (scattering) of any radiation corresponding to a transition between two different mechanical states, is in perfect analogy with the assumption generally used that a free electron will have an absorbing (scattering) influence on light of any frequency. Corresponding considerations will hold for the emission of radiation.

In analogy to the assumption used in this paper that the emission of line-spectra is due to the re-formation of atoms after one or more of the lightly bound electrons are removed, we may assume that the homogeneous Röntgen radiation is emitted during the settling down of the systems after one of the firmly bound electrons escapes, *e. g.* by impact of cathode particles*. In the next part of this paper, dealing with the constitution of atoms, we shall consider the question more closely and try to show that a calculation based on this assumption is in quantitative agreement with the results of experiments: here we shall only mention briefly a problem with which we meet in such a calculation.

* Compare J. J. Thomson, *Phil. Mag.* xxiii. p. 456 (1912).

Experiments on the phenomena of X-rays suggest that not only the emission and absorption of radiation cannot be treated by the help of the ordinary electrodynamics, but not even the result of a collision between two electrons of which the one is bound in an atom. This is perhaps most clearly shown by some very instructive calculations on the energy of β -particles emitted from radioactive substances recently published by Rutherford*. These calculations strongly suggest that an electron of great velocity in passing through an atom and colliding with the electrons bound will lose energy in distinct finite quanta. As is immediately seen, this is very different from what we might expect if the result of the collisions was governed by the usual mechanical laws. The failure of the classical mechanics in such a problem might also be expected beforehand from the absence of anything like equipartition of kinetic energy between free electrons and electrons bound in atoms. From the point of view of the "mechanical" states we see, however, that the following assumption—which is in accord with the above analogy—might be able to account for the result of Rutherford's calculation and for the absence of equipartition of kinetic energy: two colliding electrons, bound or free, will, after the collision as well as before, be in mechanical states. Obviously, the introduction of such an assumption would not make any alteration necessary in the classical treatment of a collision between two free particles. But, considering a collision between a free and a bound electron, it would follow that the bound electron by the collision could not acquire a less amount of energy than the difference in energy corresponding to successive stationary states, and consequently that the free electron which collides with it could not lose a less amount.

The preliminary and hypothetical character of the above considerations needs not to be emphasized. The intention, however, has been to show that the sketched generalization of the theory of the stationary states possibly may afford a simple basis of representing a number of experimental facts which cannot be explained by help of the ordinary electrodynamics, and that the assumptions used do not seem to be inconsistent with experiments on phenomena for which a satisfactory explanation has been given by the classical dynamics and the wave theory of light.

* E. Rutherford, *Phil. Mag.* xxiv. pp. 453 & 893 (1912).

§ 5. *The permanent State of an Atomic System.*

We shall now return to the main object of this paper—the discussion of the “permanent” state of a system consisting of nuclei and bound electrons. For a system consisting of a nucleus and an electron rotating round it, this state is, according to the above, determined by the condition that the angular momentum of the electron round the nucleus is equal to $\frac{h}{2\pi}$.

On the theory of this paper the only neutral atom which contains a single electron is the hydrogen atom. The permanent state of this atom should correspond to the values of a and ω calculated on p. 5. Unfortunately, however, we know very little of the behaviour of hydrogen atoms on account of the small dissociation of hydrogen molecules at ordinary temperatures. In order to get a closer comparison with experiments, it is necessary to consider more complicated systems.

Considering systems in which more electrons are bound by a positive nucleus, a configuration of the electrons which presents itself as a permanent state is one in which the electrons are arranged in a ring round the nucleus. In the discussion of this problem on the basis of the ordinary electrodynamics, we meet—apart from the question of the energy radiation—with new difficulties due to the question of the stability of the ring. Disregarding for a moment this latter difficulty, we shall first consider the dimensions and frequency of the systems in relation to Planck’s theory of radiation.

Let us consider a ring consisting of n electrons rotating round a nucleus of charge E , the electrons being arranged at equal angular intervals around the circumference of a circle of radius a .

The total potential energy of the system consisting of the electrons and the nucleus is

$$P = -\frac{ne^2}{a} (E - es_n),$$

where

$$s_n = \frac{1}{4} \sum_{s=1}^{s=n-1} \operatorname{cosec} \frac{s\pi}{n}.$$

For the radial force exerted on an electron by the nucleus and the other electrons we get

$$F = -\frac{1}{n} \frac{dP}{da} = -\frac{e}{a^2} (E - es_n).$$

Denoting the kinetic energy of an electron by T and neglecting the electromagnetic forces due to the motion of the electrons (see Part II.), we get, putting the centrifugal force on an electron equal to the radial force,

$$\frac{2T}{a} = \frac{e}{a^2}(E - es_n),$$

or

$$T = \frac{e}{2a}(E - es_n).$$

From this we get for the frequency of revolution

$$\omega = \frac{1}{2\pi} \sqrt{\frac{e(E - es_n)}{ma^3}}.$$

The total amount of energy W necessary transferred to the system in order to remove the electrons to infinite distances apart from the nucleus and from each other is

$$W = -P - nT = \frac{ne}{2a}(E - es_n) = nT,$$

equal to the total kinetic energy of the electrons.

We see that the only difference in the above formula and those holding for the motion of a single electron in a circular orbit round a nucleus is the exchange of E for $E - es_n$. It is also immediately seen that corresponding to the motion of an electron in an elliptical orbit round a nucleus, there will be a motion of the n electrons in which each rotates in an elliptical orbit with the nucleus in the focus, and the n electrons at any moment are situated at equal angular intervals on a circle with the nucleus as the centre. The major axis and frequency of the orbit of the single electrons will for this motion be given by the expressions (1) on p. 3 if we replace E by $E - es_n$ and W by $\frac{W}{n}$. Let us now suppose

that the system of n electrons rotating in a ring round a nucleus is formed in a way analogous to the one assumed for a single electron rotating round a nucleus. It will thus be assumed that the electrons, before the binding by the nucleus, were at a great distance apart from the latter and possessed no sensible velocities, and also that during the binding a homogeneous radiation is emitted. As in the case of a single electron, we have here that the total amount of energy emitted during the formation of the system is equal to the final kinetic energy of the electrons. If we now suppose that during the

formation of the system the electrons at any moment are situated at equal angular intervals on the circumference of a circle with the nucleus in the centre, from analogy with the considerations on p. 5 we are here led to assume the existence of a series of stationary configurations in which the kinetic energy per electron is equal to $\tau h \frac{\omega}{2}$, where τ is an entire number, h Planck's constant, and ω the frequency of revolution. The configuration in which the greatest amount of energy is emitted is, as before, the one in which $\tau=1$. This configuration we shall assume to be the permanent state of the system if the electrons in this state are arranged in a single ring. As for the case of a single electron we get that the angular momentum of each of the electrons is equal to $\frac{h}{2\pi}$. It may be remarked that instead of considering the single electrons we might have considered the ring as an entity. This would, however, lead to the same result, for in this case the frequency of revolution ω will be replaced by the frequency $n\omega$ of the radiation from the whole ring calculated from the ordinary electrodynamics, and T by the total kinetic energy nT .

There may be many other stationary states corresponding to other ways of forming the system. The assumption of the existence of such states seems necessary in order to account for the line-spectra of systems containing more than one electron (p. 11); it is also suggested by the theory of Nicholson mentioned on p. 6, to which we shall return in a moment. The consideration of the spectra, however, gives, as far as I can see, no indication of the existence of stationary states in which all the electrons are arranged in a ring and which correspond to greater values for the total energy emitted than the one we above have assumed to be the permanent state.

Further, there may be stationary configurations of a system of n electrons and a nucleus of charge E in which all the electrons are not arranged in a single ring. The question, however, of the existence of such stationary configurations is not essential for our determination of the permanent state, as long as we assume that the electrons in this state of the system are arranged in a single ring. Systems corresponding to more complicated configurations will be discussed on p. 24.

Using the relation $T = h \frac{\omega}{2}$ we get, by help of the above expressions for T and ω , values for a and ω corresponding to

the permanent state of the system which only differ from those given by the equations (3) on p. 5, by exchange of E for $E - es_n$.

The question of stability of a ring of electrons rotating round a positive charge is discussed in great detail by Sir J. J. Thomson *. An adaption of Thomson's analysis for the case here considered of a ring rotating round a nucleus of negligibly small linear dimensions is given by Nicholson †. The investigation of the problem in question naturally divides in two parts: one concerning the stability for displacements of the electrons in the plane of the ring; one concerning displacements perpendicular to this plane. As Nicholson's calculations show, the answer to the question of stability differs very much in the two cases in question. While the ring for the latter displacements in general is stable if the number of electrons is not great; the ring is in no case considered by Nicholson stable for displacements of the first kind.

According, however, to the point of view taken in this paper, the question of stability for displacements of the electrons in the plane of the ring is most intimately connected with the question of the mechanism of the binding of the electrons, and like the latter cannot be treated on the basis of the ordinary dynamics. The hypothesis of which we shall make use in the following is that the stability of a ring of electrons rotating round a nucleus is secured through the above condition of the universal constancy of the angular momentum, together with the further condition that the configuration of the particles is the one by the formation of which the greatest amount of energy is emitted. As will be shown, this hypothesis is, concerning the question of stability for a displacement of the electrons perpendicular to the plane of the ring, equivalent to that used in ordinary mechanical calculations.

Returning to the theory of Nicholson on the origin of lines observed in the spectrum of the solar corona, we shall now see that the difficulties mentioned on p. 7 may be only formal. In the first place, from the point of view considered above the objection as to the instability of the systems for displacements of the electrons in the plane of the ring may not be valid. Further, the objection as to the emission of the radiation in quanta will not have reference to the calculations in question, if we assume that in the coronal spectrum we are not dealing with a true emission but only with a scattering of radiation. This assumption seems probable if we consider

* *Loc. cit.*† *Loc. cit.*

the conditions in the celestial body in question; for on account of the enormous rarefaction of the matter there may be comparatively few collisions to disturb the stationary states and to cause a true emission of light corresponding to the transition between different stationary states; on the other hand there will in the solar corona be intense illumination of light of all frequencies which may excite the natural vibrations of the systems in the different stationary states. If the above assumption is correct, we immediately understand the entirely different form for the laws connecting the lines discussed by Nicholson and those connecting the ordinary line-spectra considered in this paper.

Proceeding to consider systems of a more complicated constitution, we shall make use of the following theorem, which can be very simply proved:—

“In every system consisting of electrons and positive nuclei, in which the nuclei are at rest and the electrons move in circular orbits with a velocity small compared with the velocity of light, the kinetic energy will be numerically equal to half the potential energy.”

By help of this theorem we get—as in the previous cases of a single electron or of a ring rotating round a nucleus—that the total amount of energy emitted, by the formation of the systems from a configuration in which the distances apart of the particles are infinitely great and in which the particles have no velocities relative to each other, is equal to the kinetic energy of the electrons in the final configuration.

In analogy with the case of a single ring we are here led to assume that corresponding to any configuration of equilibrium a series of geometrically similar, stationary configurations of the system will exist in which the kinetic energy of every electron is equal to the frequency of revolution multiplied by $\frac{\tau}{2}h$ where τ is an entire number and h

Planck's constant. In any such series of stationary configurations the one corresponding to the greatest amount of energy emitted will be the one in which τ for every electron is equal to 1. Considering that the ratio of kinetic energy to frequency for a particle rotating in a circular orbit is equal to π times the angular momentum round the centre of the orbit, we are therefore led to the following simple generalization of the hypotheses mentioned on pp. 15 and 22.

“*In any molecular system consisting of positive nuclei and electrons in which the nuclei are at rest relative to each other and the electrons move in circular orbits, the angular momentum*

of every electron round the centre of its orbit will in the permanent state of the system be equal to $\frac{h}{2\pi}$, where h is Planck's constant"*.

In analogy with the considerations on p. 23, we shall assume that a configuration satisfying this condition is stable if the total energy of the system is less than in any neighbouring configuration satisfying the same condition of the angular momentum of the electrons.

As mentioned in the introduction, the above hypothesis will be used in a following communication as a basis for a theory of the constitution of atoms and molecules. It will be shown that it leads to results which seem to be in conformity with experiments on a number of different phenomena.

The foundation of the hypothesis has been sought entirely in its relation with Planck's theory of radiation; by help of considerations given later it will be attempted to throw some further light on the foundation of it from another point of view.

April 5, 1913.

II. *On the Formation of the Molecules of the Elements and their Compounds, with Atoms as constituted on the Corpuscular-Ring Theory.* By ALBERT C. CREHORE, Ph.D.†

[Plates I. & II.]

PART I.

REASONS have been given that make it seem very probable that the atoms are constituted, as suggested by Sir J. J. Thomson, of masses of positive electrification within which negative electrons are revolving. The electrons take positions of dynamical equilibrium due to their mutual action upon each other, and upon the positive electricity. The present investigation aims, first, to obtain more exact information concerning these atoms themselves, and, second, to examine the manner in which two or more such atoms, either of the same or of different kinds, must act upon each other when brought within molecular range. To anticipate the results which are later described it is found that such atoms come to definite positions of stable equilibrium

* In the considerations leading to this hypothesis we have assumed that the velocity of the electrons is small compared with the velocity of light. The limits of the validity of this assumption will be discussed in Part II.

† Communicated by the Author.

with each other at fixed distances, thus forming the molecules of compounds. The diatomic molecules consist of two atoms rigidly held at fixed distances apart resembling the well-known dumb-bell molecule which has been deduced from the theory of heat. The reason that carbon may unite with more hydrogen atoms than nitrogen, and nitrogen with more than oxygen, and oxygen with more than fluorine, becomes apparent.

These and other conclusions are deduced from the mechanical forces between moving electrical charges that have been derived from Maxwell's electromagnetic theory. The expression for this mechanical force in the modern theory* involves the transmission of all of the effects of the moving charge with a velocity equal to that of light. The introduction of this hypothesis makes the formulæ difficult to use. It has been shown † that if the velocity of transmission is allowed to increase without limit these more recent formulæ become identical with those derived by Thomson in 1881. These latter formulæ are much simpler and can be managed. On this account, and for other reasons, it has seemed to be very desirable to know the nature of the results that can be obtained by the use of these simpler formulæ. There are reasons that will appear which make it not unlikely that results of precisely the same nature as to the formation of molecules would be obtained by the use of the more complex equations involving the velocity of light. The mathematical deductions in this paper are, therefore, derived from these Thomson equations.

For the sake of clearness the derivation of the formulæ are given in the last part of the paper, a statement and discussion of the conclusions being given first, and reference being made to the equations as required.

Before any theory can be applied to find how two atoms will act upon each other, it is necessary to have some hypothesis as to the atom itself. The distribution of the electrons within the atom on the assumption that they all lie in one plane has been approximately calculated ‡. Table I. shows the distribution from one to one hundred electrons. These calculations were based upon an assumption that the effect of the electrons in all the inside rings upon those in the outside ring is the same as if all the electrons in inside rings were at the centre of the sphere. It also assumes that the rings are true circles. From experimental evidence it seems

* See Abraham's *Elektrizität*, vol. ii.

† F. R. Sharpe, *Physical Review*, vol. xxv. Sept. 1912, p. 231.

‡ J. J. Thomson, 'The Corpuscular Theory of Matter,' p. 109 (1907).

certain that these rings are not true circles for all those combinations after the second ring begins to form, but approximate circles. If this is a fact, the theoretical difficulties are increased.

TABLE I.

	1	2	3	4	5
1	1	2	3	4	5
	5	6	7	8	8
	8	9	10	10	11
	1	1	1	2	3
	3	3	4	5	5
2	6	7	8	9	10
	11	12	12	13	13
	13	13	13	13	14
	14	14	15	15	
	5	6	7	7	8
	8	8	8	8	9
	10	10	10	10	11
	1	1	1	1	2
	2	2	3	3	3
	4	4	5	5	5
3	17	18	19	20	21
	22	23	24	25	26
	27	28	29	30	31
	15	15	16	16	16
	16	16	16	16	16
	17	17	17	17	17
	17	17	17	17	17
	11	11	11	12	12
	12	12	12	13	13
	13	13	13	13	13
	13	13	14	14	15
	15	15	15	15	15
	5	6	7	7	8
	8	8	8	8	9
	9	9	10	10	10
	10	10	10	10	11
	1	1	1	1	1
	2	2	3	3	3
	3	3	4	4	5
	5	5	5	5	5
4	32	33	34	35	36
	37	38	39	40	41
	42	43	44	45	46
	47	48			
	17	18	18	18	18
	19	19	19	19	19
	19	19	20	20	20
	20	20	20	20	20
	20	20	20	20	20
	20	20	20	20	21
	21	21	21	21	21
	15	15	15	16	16
	16	16	16	16	16
	16	16	16	16	16
	16	16	16	16	16
	11	11	11	11	12
	12	12	12	12	13
	13	13	13	13	13
	13	13	13	13	14
	14	14	15	15	15
	15	15	15	15	15
	5	5	6	7	7
	7	7	7	8	8
	8	8	8	8	8
	8	8	9	9	10
	10	10	10	10	10
	10	10	10	10	11
	1	1	1	1	1
	1	1	1	1	2
	2	2	3	3	3
	3	3	4	4	5
	5	5	5	5	5
5	49	50	51	52	53
	54	55	56	57	58
	59	60	61	62	63
	64	65	66	67	68
	69				
	21	21	21	21	21
	21	21	21	21	22
	22	22	22	22	22
	22	22	22	22	22
	22	22	22	22	23
	23	23	23	23	23
	23	23	23	23	23
	17	18	18	18	18
	18	18	18	19	19
	19	19	19	19	19
	19	19	20	20	20
	20	20	20	20	20
	20	20	20	20	20
	20	20	20	20	21
	21	21	21	21	21
	15	15	15	16	16
	16	16	16	16	16
	16	16	16	16	16
	16	16	16	16	16
	11	11	11	11	12
	12	12	12	12	13
	13	13	13	13	13
	13	13	13	13	14
	14	14	15	15	15
	15	15	15	15	15
	5	5	6	7	7
	7	7	7	8	8
	8	8	8	8	8
	8	8	9	9	10
	10	10	10	10	10
	10	10	10	10	11
	1	1	1	1	1
	1	1	1	1	2
	2	2	3	3	3
	3	3	4	4	5
	5	5	5	5	5
6	70	71	72	73	74
	75	76	77	78	79
	80	81	82	83	84
	85	86	87	88	89
	90	91	92	93	
	24	24	24	24	24
	24	24	24	24	24
	21	21	21	21	21
	17	18	18	18	18
	18	18	18	18	19
	15	15	15	16	16
	16	16	16	16	16
	11	11	11	11	12
	12	12	12	12	12
	5	5	6	7	7
	7	7	7	7	7
	1	1	1	1	1
	1	1	1	1	1
7	94	95	96	97	98
	99	100			

This table does not give the relative radii of the orbits of the various electrons, and their exact positions for equilibrium, which information is essential if we are to use such atoms as a basis for calculating the molecules of compounds. On this

account an experimental apparatus has been arranged from which approximate results have been secured.

Whether it is true or not that the electrons are confined to one plane within the positive sphere because of revolution in their orbits, there is reason to suspect that this is a fact sufficiently convincing to make it desirable to determine the exact positions of the electrons under the hypothesis that all their orbits lie in one plane in one atom. The difficulties of solution almost limit us to this hypothesis anyway, but the results seem to show that this is probably the true arrangement, thus making it unnecessary to consider a space distribution for this purpose.

Experimental Methods.

The experimental problem to be solved may then be stated as follows: given a number of equal bodies confined to one plane and perfectly free to move in that plane without friction, where will each come to rest in stable equilibrium if we suppose that they are acted upon by forces obeying two different laws? First, that each body is attracted toward one common centre by a force proportional to its displacement from that centre; and second, that each of the bodies repels each of the others by a force inversely proportional to the square of the distance between them. These are the assumptions made with reference to the electrons within the sphere of positive electrification of the atom.

An attempt has been made by others to solve this problem by the use of magnets floating upon the surface of a liquid. Some of the figures obtained in this way are shown in fig. 1 (Pl. I.). Comparing these figures with Table I., it is seen that the calculated figures are not produced in this manner by the magnets. The central rings form sooner as magnets are added than they should to reproduce the figures in the table exactly. For example, the third ring begins to form when there are but 15 magnets as compared with 17 electrons calculated.

On account of anticipated difficulties in obtaining an arrangement with magnets in a magnetic field to produce the required laws of attraction and repulsion, it was considered more probable that the conditions could be more nearly approximated by the use of electrostatic charges upon spheres. This force is the same in kind which operates between the electrons themselves, the difference being that there is a collection of electrons upon each charged sphere corresponding to a single electron in the atom. Instead of floating the spheres upon a liquid as with magnets each was

suspended as a pendulum from a common point by long conducting fibres or wires. If the deflexion is small compared with the length of the pendulum, so that the value of the angle does not differ appreciably from its sine, the force of gravity tends to return each sphere to the centre or lowest point with a force proportional to the deflexion, and by this means the positive sphere in the atom is simulated by the weight of the spheres.

If the spheres are equally charged with electricity of the same kind and the distance between adjacent spheres is large compared with their radii, then the force of repulsion between any two of them is inversely proportional to the square of the distance between them. This meets the second required condition, and such an arrangement should give the required equilibrium figures. Many practical difficulties in securing these conditions are apparent at once. How shall each sphere be given an equal charge, and how can the disturbing effect of the charge upon the supporting fibre or wire be avoided?

The facilities available in making these experiments were limited, but having secured the results described below with the means at hand, a preliminary account is given partly to show that it is very desirable to make an exhaustive study of the subject with every means that is known for making exact measurements. A steady source of direct potential such as that from a storage-battery would be an ideal electrical supply for this purpose, but since it requires between 5000 and 10,000 volts electromotive force this was not used. The available power-supply was 60 cycles alternating current at 104 or 208 volts, and this was stepped up to several thousand volts alternating potential by transformers of the closed circuit type.

For a preliminary trial aluminium spheres 0.607 cm. diameter were turned accurate to about 0.0025 cm., and a small hole drilled through on a diameter to facilitate fastening the supporting wire. A copper wire 0.0038 cm. diameter was first used. The length of the pendulum was 203 cm., and even with this fine wire the weight of the aluminium ball was not sufficient to keep it taut. Two spheres were suspended from the same point, being 30.5 cm. above the floor in the open space of the room, the wires being adjusted to the same length. One terminal of the power was connected to the point of support, and the other to a metal plate lying upon the floor under the point of suspension. With 4000 volts alternating, the spheres separated several cm., and an interesting feature was the fact that the supporting

wires did not remain straight lines from the point of support to the spheres, but each wire curved away from the other. A light weight aluminium ball was first employed in order to work with smaller voltages than would be necessary with a heavier one. However, as they were not heavy enough to keep the wire taut, a larger ball was tried also of aluminium having a diameter of .9 cm. A photograph of these two suspended spheres showing the full length of the wires was taken for the purpose of measuring their curvature after they had come to rest in their position of equilibrium. To keep them from revolving and to maintain their plane at right angles to the line of the camera they were suspended from separate points near together. By measurements on this photograph the curves assumed by the wires were obtained, shown in fig. 2 (Pl. I.).

By means of this curve much information may be obtained concerning the distribution of charge upon the conductors. The problem is the inverse of that of the suspension bridge, in which it is usual to assume a uniformly distributed dead load and calculate the curve that the cable will assume. Here the load is replaced by the distributed charge upon the wire repelled by the charge upon the other wire. The load or charge is the unknown factor, and the resulting curvature of the suspension cable is known by measurement. In this way differences between the distributions of the charges and currents for different kinds of applied voltages might be studied. A steady potential is likely to differ from an alternating one at different frequencies. There are comparatively few cases where the distribution of charge upon conductors can be calculated, and a determination of the distribution experimentally is likely to add something to our knowledge upon this subject.

Even with these heavier spheres it was found that there was not enough weight to keep this fine wire sufficiently taut to proceed to increase the number of spheres. Another kind of suspension was therefore sought. Finally a silk-fibre suspension was employed, but as this is a good insulator it was necessary to find some means of making it conducting. The most practical way was to moisten each fibre with glycerine by wetting the thumb and finger after the spheres were suspended and rubbing the whole length of the fibre. When the same alternating potential as before was applied in the same manner as with the wire suspension, the spheres would not separate at all.

It was surmised that the resistance of the fibres was so great that the spheres could not receive a sufficient alternating

charge, and this was shown to be correct by applying a direct potential. To secure it a synchronous motor was operated to drive a contact-maker in order that the spheres might be connected to the alternating potential at selected points of its phase. This method proved to be very satisfactory after a sufficient electrical capacity was added to the system to prevent too rapid a discharge of the spheres. No actual contact is required at the contact-maker, which was placed in the high-potential circuit, the voltage being sufficient to cause a spark to pass over a considerable distance in the air as the contact points approach the proper phase. In this manner, by suitably adjusting the contact distance, it was possible so to arrange the apparatus that one spark would pass at intervals of half a minute to a minute. The condenser during this interval would gradually lose its charge as it leaked away until the pressure became low enough for another spark to pass, recharging it. By means of a switch in the high-potential circuit controlled by a cord passing to a point convenient to the operator, the source of power was disconnected and the condenser left charged while a photograph of the figures assumed by the spheres was taken after they had come to rest.

When the direct potential is applied to the point supporting the spheres, they separate to a greater distance than when the alternating potential is applied if a wire suspension is used, but the distance is adjustable by altering the phase of the contact, and it is thus possible to make use of the highest point of the alternating wave. When alternating potential is applied to the silk fibres, however, there is no separation of the spheres. With the silk suspension it proved to be possible to use the lighter aluminium spheres and secure greater deflexion for the same voltage, as the fibre is stretched taut by their weight. After adjusting each pendulum to the same length as they hang quietly side by side, a charge is suddenly given the condenser, and the high-potential switch opened immediately thereafter, leaving the condenser connected to the spheres charged. With the first charge the spheres suddenly separate from each other, and oscillate about positions of equilibrium, finally coming to rest in these positions. Each silk fibre separates from its neighbour owing to the charge it carries, and on this account the spheres are free to oscillate without so much danger of their getting twisted or tangled together. After they have come to rest a photograph is secured. The camera was placed about 30 cm. above the point of support of the spheres just enough to one side of it to avoid interference

with the view. As the distance from the spheres was at least 250 cm., this displacement of the camera by 2.5 cm. to one side of the vertical line caused no appreciable distortion due to perspective. It is most fascinating and instructive to watch the oscillations of the spheres as they are assuming their final positions. A moving picture film recording these motions might be instructive, and certainly would be of interest.

In this manner the set of negatives of each combination from two to eleven spheres, reproduced in fig. 3 (Pl. II.), was obtained. The plates used were $3\frac{1}{4}$ by $4\frac{1}{4}$ inches, a size adapted for use in a stereopticon. When measurements are desired, the figures are projected by the lantern upon a drawing-board and the positions marked in the enlargement, where measurements may easily be made with some degree of accuracy. This set of negatives was secured during the first three days of May, but on the next day rain and wet weather set in, which entirely prevented any repetition of the series in the same manner, because the condenser would immediately discharge at such a rate that there was not time for the oscillations to die out, and for the figures to be formed, although there was furnace-heat in the room for the purpose of keeping the apparatus dry. It will not be practicable to work again by this method until the cold dry season. The method is very satisfactory because there is no disturbing cause for variation of potential which is always present when the source of power is connected. On account of the weather another plan was adopted and good negatives secured, as described below.

An examination of the figures assumed by the spheres in fig. 3 (Pl. II.) shows that they not only differ from those in the calculated table, but also from those obtained with magnets. With magnets the central rings begin to form earlier for a smaller number of magnets than the calculated figures, and they form earlier still in fig. 3. The whole series may be said to be farther away from the figures in Table I. than those obtained with magnets. For example, the third ring begins to form when the eleventh sphere is added, instead of at the seventeenth electron as in the table.

With an arrangement like this all the spheres, being connected together, are at the same electrical potential, and the charge is greater on the spheres in the outside ring than upon those in the centre of the system. Hence, the desired figures ought not to be formed without further modification.

Before describing any modification of this experiment, it

should be noted that by carefully manipulating the spheres with a glass rod held in the hand while they are charged, it is possible to alter the arrangement of the figures and produce alternative configurations with the same number of spheres. With four spheres it is possible to produce two figures, one a square, and the other an equilateral triangle with one sphere at the centre (no photograph of this was secured), and each arrangement is in perfect equilibrium. With five spheres either a pentagon or a square with one at the centre is obtained. There are two alternative figures obtained with six also, only one of which is shown in this figure. A complete description of this interesting case is given below*.

Being temporarily obliged to use some arrangement whereby the power could be applied continuously, or in such rapid succession as to be in effect continuous, a different form of synchronous motor and contact-maker was devised by which the condenser is charged and discharged at each cycle of the alternating power. A heavier sphere than heretofore was used, so that the fine copper wire could be employed. Lead buck-shot were tried, but the difficulty of making them equal in weight and size prevented their use. It is very important to employ spheres as nearly equal as possible. A steel ball .794 cm. diameter, such as is used for ball-bearings, was next tried and found to be satisfactory. The reason for not employing them earlier was the fear that their magnetic effect might introduce additional difficulty, but this did not prove to be the case. With these larger spheres it is necessary to employ higher voltage to maintain the distances between the spheres large compared with their diameter. The available alternating potential was not great enough to make a figure of sufficient size. The potential might have been increased by additional transformers, but the liability of putting undue strain upon the insulation of the transformers as well as the increased danger in working with the apparatus, decided against the plan. Hence, the synchronous contact-maker and condenser were employed. It was found that with the contact-maker there was a deflexion obtained when a silk-fibre suspension was used, but that it was much greater when wire was substituted for the fibre. The charge was thus shown to be a mixture of alternating and direct potential, and it seems probable that there was a high frequency charge and discharge of the condenser with each spark, though no direct measurement of this was made.

* See page 83.

The purpose in view was to produce if possible a set of figures exactly similar to those in the calculated Table I., and the means by which this was accomplished were considered of secondary importance. Exact measurements may be made afterwards. This is proceeding upon the principle that if the proper series of figures were obtained, the probability is that the laws of force assumed when those figures were calculated would be fairly closely approximated, and the results seem to show that this is correct.

With this source of power it is not possible to avoid a continual vibration of the supporting wires, and this is so great that the figures cannot be obtained when the suspension is in free air. The spheres only were immersed in a bath of oil. There is a two-fold advantage in this: first, the spheres come to their equilibrium positions without oscillation and remain at rest in these positions; and second, by using the proper oil the specific inductive capacity of the medium is increased several fold, and the charge on the spheres increased in greater proportion than that upon the supporting wires which are in the air. This makes the effect of the supporting wires more negligible, and approximates nearer to the desired condition. In the tables the specific inductive capacity of castor-oil is given as 4.7, and this was used partly because of its large value, and also because it is viscous at ordinary temperatures and quite transparent, which is better for securing photographs. The temperature was controlled by a spirit-lamp under the oil-bath, and the viscosity of the oil kept at any desired point. At 21° C. it is about right.

A series of photographs secured with the 0.794 cm. steel balls suspended in castor-oil is shown in fig. 4 (Pl. II.). The figures are seen to resemble those of the first set, fig. 3, in that the rings are formed in the centre for a smaller number of spheres than either those with magnets or the calculated table.

The next process was to control the figures, which was accomplished by surrounding the spheres and suspension wires by conductors connected to the opposite terminal of the power from the spheres. The final arrangement was to surround the whole system by an iron wire screen about 30.5 cm. in diameter and 53 cm. high resting upon a flat steel plate, the distance of which below the spheres was adjustable. By this means it was found that the exact figures calculated in Table I. could be reproduced. The exact distribution of the charge has not as yet been measured. When there is only a single ring of spheres, it may be said

from symmetry that the charges are equal, but when there are two or more rings the relative charges should be measured. By giving a proper curvature to the surface under the spheres, and adjusting the lengths of the pendulums to suit, it seems not unlikely that all the conditions may be met to obtain ideal experimental atoms, but this has not yet been attempted.

No careful measurements of the negatives were made until those were obtained which gave a series similar to the calculated table. Such a series is given in fig. 5 (Pl. II.) It is seen that the alternative figures for the same number of spheres persist throughout the set, it being possible to form sometimes two, three, or four different equilibrium figures with the same number of spheres.

Experimental Results.

The chief results of the experiment are summarized in the Table II. (pp. 36-7) and the charts, figs. 6 & 7 (Pl. I.). The radius, b , of the positive sphere of the atom is calculated by the formula (72) on the assumption that the density of the positive electricity is uniform, so that the volume of the sphere increases in proportion to the number of electrons within it, and the radius as the cube root of the number of electrons. This gives the smooth curve in fig. 6. The radius, a_1 , of the outside ring is then calculated on the assumption that all the electrons in the inside rings are at the centre of the sphere, since it may be obtained from formula (74). A correction term, c , is then obtained, as explained on page 80, for the purpose of correcting the radius of the outside ring, so that the true radius is obtained as if the inside electrons are distributed in rings and not assumed to be at the centre of the sphere. This gives a slightly larger radius, a_{1c} , in each instance than is given by the formula.

Having obtained the radius of the outside ring of electrons, the radii of the other rings are found from the experimental atoms, since the ratios, r_2 , of the average radii of the outside ring to the second ring have been carefully measured in each instance. a_2 gives the radius of the second ring, and a_{2c} its corrected value. The column Σa gives the sum of the radii of the orbit of each electron in the atom. The broken lines in fig. 6 show the radii of the outside ring in the various experimental atoms, and those in fig. 7 show the sums of the radii as given in the table. The experimental work can be judged in a measure from this chart by the smoothness of the curves, each point of which is determined from the

TABLE II.

Neg. No.	Element.	p .	n_1 .	n_2 .	n_3 .	b .	a_1 .	a_{1c} .	c .	r_3 .	a_2 .	a_{2c} .	Σa .	At. Wt.
1 <i>a</i> .	Æther	1	1	0	0	0.794	0.000	0.000
1 <i>c</i> .	Hydrogen	2	2	0	0	1.000	0.500	1.000	1.008
2 <i>c</i>	3	3	0	0	1.145	0.661	1.983	...
3 <i>c</i>	4	4	0	0	1.260	0.782	3.128	...
5 <i>c</i>	5	5	0	0	1.357	0.883	4.415	...
7 <i>c</i>	6	6	0	0	1.443	0.970	5.822	...
1 <i>h</i>	4	3	1	0	1.260	0.923	2.769	...
4 <i>c</i>	5	4	1	0	1.357	0.993	3.970	...
6 <i>c</i>	6	5	1	0	1.443	1.060	5.30	...
8 <i>c</i>	7	6	1	0	1.518	1.122	6.732	...
10 <i>c</i>	8	7	1	0	1.587	1.185	8.295	...
4 <i>h</i>	9	8	1	0	1.651	1.239	9.915	...
9 <i>c</i>	8	6	2	0	1.587	1.241	3.50	8.15	...
11 <i>c</i>	9	7	2	0	1.651	1.294	1.305	0.12	3.84	0.34	...	9.75	...
6 <i>h</i>	10	8	2	0	1.710	1.339	3.94	0.339	...	11.39	...
3 <i>h</i>	9	6	3	0	1.651	1.341	2.90	0.463	...	9.435	...
5 <i>h</i>	10	7	3	0	1.710	1.386	1.409	0.27	2.97	0.467	0.475	11.10	...
8 <i>h</i>	11	8	3	0	1.765	1.426	3.20	0.445	...	12.75	12.00
10 <i>h</i>	12	9	3	0	1.817	1.469	3.40	0.432	...	14.52	14.01
13 <i>h</i>	13	10	3	0	1.867	1.510	3.35	0.451	...	16.45	...

16 <i>h.</i>	10	6	4	0	1.710	1.428	...	2.62	0.545	...	10.748	...
7 <i>h.</i>	11	7	4	0	1.765	1.468	0.48	2.68	0.549	0.562	12.47	...
9 <i>h.</i>	12	8	4	0	1.871	1.504	...	2.88	0.522	...	14.128	...
12 <i>h.</i>	13	9	4	0	1.867	1.540	...	2.85	0.540	...	16.02	16.00
3 <i>d.</i>	14	10	4	0	1.913	1.580	...	2.92	0.544	...	17.976	...
14 <i>h.</i>	13	8	5	0	1.867	1.574	0.68	2.57	0.616	0.630	15.64	...
14 <i>h.</i>	14	9	5	0	1.913	1.605	0.63	2.62	0.602	0.630	17.46	...
6 <i>d.</i>	15	10	5	0	1.957	1.640	...	2.68	0.613	...	19.47	19.0
10 <i>d.</i>	16	11	5	0	2.000	1.676	...	2.78	0.605	...	21.47	...
1 <i>j.</i>	13	8	4	1	1.867	1.574	...	2.33	0.677	...	15.30	...
2 <i>j.</i>	14	9	4	1	1.913	1.609	...	2.32	0.682	...	17.20	...
3 <i>j.</i>	15	10	4	1	1.957	1.640	0.58	2.46	0.668	0.682	19.07	...
1 <i>d.</i>	14	8	5	1	1.913	1.640	...	2.13	0.786	...	16.80	...
4 <i>d.</i>	15	9	5	1	1.957	1.666	...	2.23	0.748	...	18.73	...
9 <i>d.</i>	16	10	5	1	2.000	1.702	...	2.31	0.737	...	20.71	...
12 <i>d.</i>	17	11	5	1	2.048	1.740	...	2.36	0.785	...	22.82	...
8 <i>d.</i>	16	9	6	1	2.000	1.728	...	2.19	0.790	...	20.29	...
11 <i>d.</i>	17	10	6	1	2.048	1.760	1.08	2.23	0.793	0.815	22.36	...
14 <i>d.</i>	18	11	6	1	2.080	1.785	...	2.31	0.774	...	24.28	...
...	18	10	7	1	2.080	1.810
15 <i>d.</i>	19	11	7	1	2.118	1.835	...	2.29	0.800	...	25.79	...
16 <i>d.</i>	20	12	7	1	2.080	1.810	...	2.06	0.880	...	23.95	...
13 <i>d.</i>	18	10	6	2	2.080	1.810	$r_3 = 6.35$	$a_3 = .285$

experiment. Take, for example, the curve passing through the combinations 6-4, 7-4, 8-4, 9-4, and 10-4, each of which gives stable figures. This shows a systematic law of change, which suddenly jumps, when there are 15 electrons, to the next broken line. The chart shows a relationship not so plainly seen from the table. When there are alternative combinations with the same number of electrons, the sums of their radii differ.

The names of the elements, provisionally assigned to certain combinations of the electrons, have been so adopted for purposes of convenience of reference. It is more convenient to refer to the combinations by means of a chemical symbol, as N denoting nitrogen, than to give their numbers, $12=9+3$. The assignment has been made as nearly correct as possible in accordance with the indications of the periodic * table of the elements. The atomic weights of the elements are seen to correspond in an approximate manner only with the sum of the radii of the orbits of the electrons.

The calculated radii given in the table are not sensibly changed by the angular velocity of revolution of the whole atom. This velocity is allowed for in the formula, and the probability is that it is such that the change in the radii may be entirely neglected, as being small compared with the errors in determining the radii by experiment.

PART II.

Combinations of Atoms.

The atoms, as described, have been determined with sufficient definiteness to make possible a calculation of the attraction or repulsion that one may have for another. This depends upon the expressions for the mechanical force which one moving electron exerts upon another. A definite example with the simplest atom containing but two electrons within a positive sphere will serve to illustrate the method of procedure. First, suppose that there are two such atoms placed one over the other so that the axes of their orbits are coincident, and their planes parallel. Moreover, suppose for simplicity that the electrons are in phase, the one standing directly over the other, all four lying in the same meridian plane. We will suppose at first that the electrons are at rest in these positions, for there are then the ordinary electrostatic forces of attraction and repulsion between the various parts of the atom. As soon as revolution begins

* A. C. Crehore, *Physical Review*, vol. xiv. no. 4, Apr. 1912.

additional forces are brought into play, but the forces that act when they were at rest still continue to act. If the atoms are A and A' and the electrons within A are e_1, e_2 , and within A' e_1', e_2' , the electron e_1 repels e_1' with a force $\frac{e^2}{r^2}$, and e_1 repels e_2' , diagonally opposite, with a force $\frac{e^2 r}{(r^2 + 4a^2)^{\frac{3}{2}}}$ when resolved along OO', "a" denoting the radius of the orbit of each electron. e_2 repels e_2' and e_2 repels e_1' in like manner, thus doubling the sum of the forces found, for the total repulsion between the electrons themselves. Electron e_1 attracts the positive sphere $2e$ of the opposite atom with a force which, when resolved along the line OO' joining the centres, is equal to $\frac{2e^2 r}{(r^2 + a^2)^{\frac{3}{2}}}$. Each of the four electrons acts upon the opposite sphere in the same manner, giving a total attraction four times the preceding. There is, in addition, the repulsion between the positive spheres themselves, which is $4\frac{e^2}{r^2}$. Hence the total electrostatic force between the atoms, assuming that they are at rest, is

$$F = \frac{8e^2 r}{(r^2 + a^2)^{\frac{3}{2}}} - \frac{2e^2 r}{(r^2 + 4a^2)^{\frac{3}{2}}} - \frac{6e^2}{r^2}.$$

If the distance r is expressed as av , where v denotes the distance between the atoms measured in radii, the force becomes

$$F = \frac{e^2}{a^2} \left[\frac{8v}{(v^2 + 1)^{\frac{3}{2}}} - \frac{2v}{(v^2 + 4)^{\frac{3}{2}}} - \frac{6}{v^2} \right].$$

The negative terms denoting repulsion may be shown to exceed the positive term at all distances. If each term is expanded into a series of terms by the binomial theorem, we find

$$\begin{aligned} \frac{8v}{(v^2 + 1)^{\frac{3}{2}}} &= 8v^{-2} - 12v^{-4} + 15v^{-6} - \frac{35}{2}v^{-8} + \frac{315}{16}v^{-10} - \dots, \\ -\frac{2v}{(v^2 + 4)^{\frac{3}{2}}} &= -2v^{-2} + 12v^{-4} - 60v^{-6} + 280v^{-8} - 1260v^{-10} + \dots, \\ -\frac{6}{v^2} &= -6v^{-2}. \end{aligned}$$

Hence

$$F = \frac{e^2}{a^2} (-45v^{-6} + 262.5v^{-8} - 1240.31v^{-10} + \dots),$$

which gives the electrostatic force between the two atoms at

any distance. It is to be observed that the second and fourth power terms exactly cancel each other, leaving the total force controlled by the principal term denoting a repulsion, and varying as the inverse sixth power of the distance. For very small values of v the series is not rapidly convergent. If the value of v is 4, the positive spheres just touch each other, and at this distance, by the first equation, $F = -0.008 \frac{e^2}{a^2}$. That is, the whole repulsion

between the atoms, containing in all four electrons, even when in contact is only 8/1000 of the repulsion that exists between two free electrons at one quarter the distance, or about 1/8th of the repulsion there is between two electrons at the same distance. To illustrate the very rapid decrease of the repulsion with the distance, when the second atom is 1000 radii distant from the first the repulsion is $45 \times 10^{-18} \frac{e^2}{a^2}$, and the repulsion between two free electrons at the same distance is $10^{-6} \times \frac{e^2}{a^2}$, which is 2.2×10^{10} times greater than the actual repulsion between the atoms.

If the electrons in the two atoms are now supposed to revolve around the common axis, new forces are brought into existence which oppose the electrostatic forces, and it is shown, by considering these new forces alone which are due to the revolution, that their effect upon the atoms as a whole produces a resulting attraction varying, not as the inverse sixth power, but as the inverse fourth power of the distance between them. Because of this difference between the two laws of variation of the forces with the distance, it is evident that at great distances the attraction between the atoms must exceed the repulsion, and at small distances the repulsion must be greater. At a certain definite distance, therefore, the repulsion exactly balances the attraction, allowing the atoms to come to equilibrium at this distance. It is shown later that the equilibrium is not stable in this position, but this does not invalidate the general conclusions now under consideration. The fixed distance at which the atoms finally come to stable equilibrium depends entirely upon the speed of the electrons in their orbits, but the distance is probably many times greater than the radius of the orbit. This distance between the atoms may be regarded as of the order of magnitude of the dimensions of molecules which are thus seen to be of an entirely different order of magnitude from the atoms of which they are composed.

The attractive force varying as the inverse fourth power of

the distance rapidly diminishes with increasing distance to a value which is less than the gravitational attraction between the atoms. Without assigning any cause for the existence of the gravitational force, no one doubts that there is a small force between the atoms varying as the inverse square of the distance. This force, no matter how small, must at great distances exceed any force varying as the inverse fourth power, and at small distances must be negligible comparatively. There is, therefore, a second critical distance where the forces varying as the inverse second and fourth powers of the distance become equal to each other. This critical distance explains the existence of what is known as molecular range, a distance at which the law of gravity changes. This is probably many times greater than the first critical distance giving the dimensions of the molecule.

Method of calculating the Forces between Atoms.

The manner in which the forces between the atoms have been calculated from the equations (1) to (4) for the instantaneous force between two moving charges is as follows. Two electrons are first assumed to be moving each at a uniform rate in some fixed circular orbit, as they would if each formed a part of two separate atoms, and the whole atom is not supposed to move from one fixed position while the electron executes several revolutions within it. Expressions for the instantaneous values of these four component forces, as functions of the time, are then obtained. As each depends upon the instantaneous distance between the two electrons, it is required to find this distance as a function of the time. When the distance between the centres of the two orbits is so large compared with the radii of the orbits that all distances from any part of one orbit to the other are sensibly parallel, the expression for the distance between the electrons is a comparatively simple function of the time; but, when the centres of the orbits are as near to each other as you please, and their axes turned at any angle, and the rates of revolution different, the complete value of the square of the distance is given by equation (11). R is the instantaneous distance between the electrons; a and a' the radii of the orbits; ω and ω' the angular velocities; x , y , and z the components of r , the constant distance between the centres of the orbits, referred to a set of rectangular axes with origin at the centre of the orbit of electron, e . The y -axis is assumed to be parallel to the line of intersection of the planes of the two orbits, and the x -axis is in the plane of the orbit of e . the

z -axis being coincident with the axis of rotation of e . α is the angle between the directions of the axes.

Since the instantaneous values of the four component forces each act in different directions, they are resolved in each instance along three selected rectangular axes. The atom, in which the electron, e , describes a circular orbit, may be considered to have an equator, poles, meridians and circles of latitudes. The selected axes are, first, along the line joining the centres of the orbits, OO' ; second, perpendicular to OO' in the plane of the meridian of e ; and third, perpendicular to each of these directions along the circle of latitude. The complete expression for the instantaneous force due to the first component is given by (18), and due to the second component by (23). These forces are then averaged over a long period of time, and the resulting expressions give the attraction or repulsion, as the case may be, along the line OO' joining the centres of the orbits, which the two electrons contribute toward the force between the atoms.

When the average is taken, different results are obtained according to the assumption made as to the relative angular velocities of rotation of the electrons in the two orbits. When these velocities are equal to each other, there is a particular solution which does not obtain when they are incommensurable. When two atoms are in equilibrium with each other forming a molecule, it has been shown that if their electrons are displaced a little from a fixed phase relation, the moment of the forces tends to return them to their original phase relation, and they are again in phase equilibrium. It is considered that, if the periods of revolution are nearly the same, they will become synchronized during the process of forming a stable molecule. This emphasizes the importance of obtaining the solution of the equations on the assumption of equal angular velocities; and, while the work has not been entirely restricted to this hypothesis, the chief results as applied to stable molecules are based upon this assumption. With this understanding, the average force along the line OO' between the two electrons due to the first component is given by (24), and due to the second component by (25).

The third and fourth components of the force, (3) and (4), have not been mentioned because it is shown generally, page 63, that, while their instantaneous values are not zero individually, their sum is always zero when averaged over a long time. These components contribute nothing, therefore, to the translational force between two atoms, and the whole force is obtained from the first and second components. They do, however, contribute much toward the internal

moments of the force, determining the relative positions of the axes of rotation, and the phase positions of the electrons in their orbits for equilibrium. If the axes of the two orbits are not parallel to each other, the forces due to the third and fourth components have a tendency to alter the direction of the axis of rotation, since these forces act parallel to the acceleration and the velocity of the second charge, that is, in a plane parallel to the orbit of e' . If the planes are exactly parallel, on the other hand, there is no component of these forces perpendicular to the common planes, and, consequently, no tendency to alter the direction of the axes. This is, therefore, the stable condition. If the axis of rotation is slightly disturbed, there are forces tending to return it to parallelism, and at the same time giving the whole system all the effects of a gyroscopic motion. The gyroscopic motion of the whole atom must, however, be of a peculiarly modified character because of the flexibility of the rings of electrons not being exactly the same as if the ring were a rigid body.

In this discussion the first and second components of the force have been omitted from consideration because, when the two atoms have come to positions of equilibrium forming a molecule, the average translational force is zero in this position, the first and second components exactly balancing each other; and, although their instantaneous values do not balance, it is thought that their joint effect in determining the direction of the axis is negligible in comparison with that due to the third and fourth components.

The quantity " u " (12), which is the chief part of the variable distance, R , between the electrons, enters the instantaneous values of the forces (18) and (23) as an infinite series. The first power of u only has been included in the average equations (24) and (25), and these expressions are even then too complex to be of much value. The approximation is better the larger the value of r . In the molecules, it is considered, for the reasons given above, that the axes of the atoms are approximately parallel to each other. The introduction of this assumption greatly simplifies the expressions for the forces. The value of u becomes (26), and the product of the vector velocities of the electrons which enters into the second component (2) becomes a constant (27) independent of the time. The instantaneous value of the first component force becomes (28), and it is now easy to derive the average value of the second component from the first component because of the constancy of the product of these velocities. The first component multiplied by the

constant, $\beta\beta' \cos \gamma$, gives the second component. Here β denotes the ratio of the linear velocity, q , of the electron, e , to that of light, c ; and γ the phase difference between the positions of the two electrons in their respective orbits.

Owing to this simplification it has been possible to obtain a general solution (42) for the average value of the force between two electrons due to the first component, in which all the powers of u are included, since the law of the series of terms entering into the force-equation has been found.

The instantaneous value of the force perpendicular to OO' in the meridian plane is given by (23), and the average value in the general form in (44). The instantaneous force along the circle of latitude, that is, in a direction perpendicular to each of the other two directions, is given by (38). When this force is integrated between the limits $t=0$ and $t=\infty$ to find its average value, the result gives zero for the force in this direction.

Application to Atoms.

To find the whole force between two atoms, in distinction to two electrons, similar equations are written down for each combination of pairs of charges that there is in the two atoms, taking one charge from each and forming all possible combinations including each of the electrons and the two positive spheres. In taking the sum of such components, due, say, to the effect of one electron in the one atom upon a ring of equally-spaced electrons in the other atom, it is necessary to add together the different powers of the cosines of the phase-angles, γ , between the single electron and each of those in the ring. The following propositions concerning the addition of the various powers of the cosine will be found useful. If there are n points equally spaced in a circle, then the sums of the powers of the cosine of the angles, measured from the centre of the circle, between any point in the circle and each of the n points are as follows:—

$$\sum_{\lambda=1}^{\lambda=n} \cos \left(\gamma + \lambda \frac{2\pi}{n} \right) = 0 ; \text{ except for } n=1, \text{ when } \Sigma = \cos \gamma ;$$

$$\sum_{\lambda=1}^{\lambda=n} \cos^2 \left(\gamma + \lambda \frac{2\pi}{n} \right) = \frac{n}{2} ; \text{ except for } n=1, \text{ or } 2, \\ \text{when } \Sigma = \cos^2 \gamma \text{ or } 2 \cos^2 \gamma ;$$

$$\sum_{\lambda=1}^{\lambda=n} \cos^3 \left(\gamma + \lambda \frac{2\pi}{n} \right) = 0 ; \text{ except for } n=1, \text{ or } 3, \\ \text{when } \Sigma = \cos^3 \gamma \text{ or } \frac{3}{4} \cos 3\gamma ;$$

$$\sum_{\lambda=1}^{\lambda=n} \cos^4 \left(\gamma + \lambda \frac{2\pi}{n} \right) = \frac{3n}{8} ; \text{ except for } n=1, 2, \text{ or } 4, \\ \text{when } \Sigma = \cos^4 \gamma, 2 \cos^4 \gamma, \text{ or } \frac{1}{2} \cos 4\gamma + \frac{3}{2}.$$

Generally the sums of the odd powers of the cosines are zero, and the sums of the even powers are constant, independent of the initial phase-angle, γ , except in the very special cases where the number of electrons in the ring is small. In certain atoms this number is small, and the resulting force depends to a large extent upon the relative phase-angles; but in the majority of them the equilibrium position is independent of this phase-angle to a very close degree of approximation. To illustrate: when there is a ring containing but two electrons in each atom, the force involves the phase-angle γ in those terms containing the inverse sixth power of the distance, v^{-6} , and with a ring of three electrons terms do not appear until v^{-8} . For most purposes the approximation is sufficiently close for a determination of the equilibrium position if we neglect all terms containing v^{-8} and higher powers; so that it happens that in all the cases, except when there is a ring of two electrons in each atom, the equilibrium position is approximately independent of the relative phase-angles of the different electrons.

Equations (45) and (46) give the complete values of the forces which the atom A' exerts upon A including the inverse sixth power of v , except for certain terms containing β which are negligible in comparison with the other terms. These equations may safely be used for atoms, except in the case where each atom has one ring with two electrons. It may be used if one atom has such a ring and the other has not.

Table III. gives the values of the ratios m_1, m_2 , of the radii of the outside and second rings of electrons in several selected atoms, referred to the radius of the single ring atom having but three electrons; also the values of k_2 and k_4 (48) and

TABLE III.

	m_1 .	m_2 .	k_2 .	k_4 .	k_4/k_2 .
2,0	0.7566	0.000	1.144	0.655	0.573
3,0	1.0000	0.000	3.000	3.000	1.000
4,1	1.505	0.000	9.064	20.48	2.26
6,1	1.700	0.000	17.34	50.10	2.89
8,1	1.875	0.000	28.20	98.80	3.50
8,2	2.03	0.590	33.46	135.63	4.05
8,3	2.195	0.689	39.99	186.52	4.66
9,3	2.255	0.666	47.05	232.79	4.95
9,4	2.385	0.832	53.96	293.16	5.44
10,5	2.545	0.971	69.49	423.95	6.10

their ratios k_4/k_2 . Table IV. gives the products $k_2 k_2'$ for the different combinations; and Table V. the values of " h ," $\cos^2 \lambda$ and λ . With the data the equations for the forces between any two of the atoms may be written in full.

TABLE IV.

 $k_2 k_2'$.

	2,0	3,0	4,1	6,1	8,1	8,2	8,3	9,3	9,4	10,5
2,0	1.31	3.43	10.37	19.85	33.40	38.35	45.75	53.9	61.7	79.5
3,0		9.00	52.0	87.6	84.6	100.4	120.0	141.15	161.8	208.5
4,1			82.0	157.0	255.5	303.0	362.	426.0	488.0	629.0
6,1				301.0	489.0	581.	693.	816.	935.	1205.
8,1					795.0	944.	1128.	1328.	1520.	1960.
8,2						1120.	1338.	1575.	1805.	2325.
8,3							1600.	1885.	2158.	2780.
9,3								2215.	2535.	3270.
9,4									2910.	3745.
10,5										4825.

TABLE V.

 h .

		H	C	N	O	F
	2,0.	3,0.	8,3.	9,3.	9,4.	10,5.
2,0	$h =$	1008	3317	3497	3806	4221
	$\cos^2 \lambda =$	0.1894	0.1043	0.1015	0.0974	0.0927
	$\lambda =$	64° 12'	71° 9'	71° 25'	71° 49'	72° 16'
3,0	H.	1277.5	3586	3766	4075	4490
		16765	0.1003	0.09805	0.0942	0.0901
		65° 50'	71° 32'	71° 45'	72° 8'	72° 32'
8,3	C.		5895	6075	6384	6799
			0.0788	0.0778	0.07594	0.0735
			73° 42'	73° 48'	74° 0'	74° 16'
9,3	N.			6254.5	6563	6979
				0.0767	0.07514	0.0727
				73° 55'	74° 5'	74° 22'
9,4	O.				6872	7288
					0.0734	0.0712
					74° 17'	74° 32'
10,5	F.					7704
						0.0692
						74° 45'

By equating to zero both equations (45) and (46) we have the condition for the equilibrium of the two atoms to which they correspond. There are in effect but two variables in

these equations—the product, βv , which is proportional to the distance between the atoms, and the angle of latitude, λ , each of which is thereby determined. It is shown later that these values give the stable position of the two atoms. These equations for the zero force along and perpendicular to the line joining the centres of the atoms are shown graphically for several different combinations of atoms in fig. 8 (Pl. I.). The perpendicular zero-force curve is precisely the same, to this degree of approximation, for each combination of the atoms, the equation being independent of h ; but the along-force curve differs according to the particular atoms. At the points of intersection of the two curves the force is zero in all directions, and these are stable equilibrium positions for the two atoms. All the along-force curves intersect the axis at a common distance $\beta^2 v^2 = 5$, and the perpendicular curve intersects at a greater distance, $\beta^2 v^2 = 10$. The directions of the forces are shown by the arrows; for all points above or without the along-curves the force is an attraction towards O, changing direction at the curve of zero force; and for points within, the force is a repulsion. The perpendicular force has a direction away from the axis for all points within the critical distance $\beta^2 v^2 = 10$, and toward the axis for all points without. At the equator the perpendicular force is zero, but for any small displacement it is away from the equator. It is evident from the figure that the forces restore the atom to the intersection of the along and perpendicular curves for any small displacement from this position.

It has been shown, equation (38), that the force upon the atom along the circle of latitude, that is, perpendicular to the paper in the figure, is zero. The atom is, therefore, free to stand at any point in either of the two circles of revolution generated by the along and perpendicular curves about the axis. The distance between the atoms of the different diatomic molecules is represented by the radius vector from the origin to some point upon the perpendicular curve, being greater than $\beta^2 v^2 = 7.075$ and less than $\beta^2 v^2 = 10$. If the distance between the atoms in the diatomic molecule is the dimension of the molecule, then it appears that all diatomic molecules have about the same dimensions, even though the atoms of which they are composed vary greatly in size.

It seems that there is yet great uncertainty in the determination of the relative dimensions of the atom, the molecule, and the average space required by a single molecule within a solid or liquid substance. The latter may be found with a fair degree of accuracy in the case of a few substances which can be measured in both the gaseous and the liquid forms.

Table VI. gives the volume in cub. cm. allotted to one molecule in the liquid form for nine different substances, and the data from which the information is derived. The number of molecules in a cub. cm. of gas at the standard pressure and

TABLE VI.

	Density referred to air.	Cub. cm. per gram.	Density referred to water.	Cub. cm. per Molecule. 10^{-24}	Cm. per Molecule. 10^{-8}
O	0·0014292	700·	1·14	46·4	3·595
H	0·00009004	11110·	0·070	47·7	3·628
F	0·001697	590·	1·14	55·1	3·81
N	0·0012542	798·	0·810	57·4	3·86
A	0·001782	562·	0·854	54·4	3·79
			1·3845	47·6	3·625
Br	0·0071426	140·3	1·4233	46·2	3·59
			3·187	83·	4·37
Cl	0·0031666	316·	3·15	84·	4·38
			1·507	78·	4·27
Xe	0·005717	175·	3·52	60·1	3·92
H ₂ O ...	0·000581	1723·	1·00	29·3	3·08

temperature is taken as $2·7 \times 10^{19}$. The last column gives the average distance from the centre of one to the centre of the adjacent molecule in cms. These figures are surprisingly near to equality, much nearer than they would be were the space proportional to the size of the atoms composing the substance. If the diatomic molecule is formed in the manner indicated by the equations, it would be unreasonable to suppose that any atoms in the adjacent molecules of a solid could be nearer together than the two atoms of the molecule itself. The space allotted to one molecule in these substances agrees well with the conception that each molecule is of the same order of magnitude as any other. How much of this distance between adjacent molecules is interspace, and how much is occupied by the molecule, as well as the relative sizes of the atom and molecule, is most important to determine.

Before entering upon this question, some consideration will be given to the manner in which more than two atoms may combine to form the molecules of compounds. The curves of zero force shown in fig. 8 are independent of any assumption as to the speed of the electrons within the atoms.

Although these curves in terms of βv are independent of the speed of the electrons, the distance, v , and the force do depend upon the value of β . The two figures, 9 and 10, represent the lines of equal force between two atoms. In making such figures it is necessary to assume a definite pair of atoms, and also the value of the speed of the electrons; for the results differ for different atoms and the speeds of their electrons. The case represented is that of two similar atoms each having but a single ring of three electrons, and it is assumed that their linear velocity is $1/316$ that of light, that is, $\beta = .00316$ and $\beta^2 = 10^{-5}$. The dotted curves of zero force are alike on the two charts, and are similar to the βv curves in fig. 8 (Pl. I.). The full lines are lines of equal force, fig. 9 showing the force along the radius vector joining the point and the origin, that is, joining the two atoms, and fig. 10 showing the force upon the atom perpendicular to this radius, in the meridian plane. The rate of change of the force and its direction at each point are shown. In passing from one curve to the adjacent curve the force changes by a constant amount, $\frac{3}{16} \frac{e^2}{a^2} \times 10^{-16}$ dyne. Upon the axis the force is an attraction which increases as the atoms approach from an infinite distance until a point of maximum force is reached, after passing which the force decreases to zero and reverses direction, becoming a repulsion. The rate of change is then very rapid with decreasing distance. Some curves showing the variation of the force on the axis and on the equator as well as along several fixed radii, each curve being designated by a number which is the square of cosine λ , are given in fig. 11 for the forces along the radius, and fig. 12 for forces perpendicular to the radius. The force is a repulsion at all distances on the equator. It should be stated, however, that for small distances, such as that between atoms whose positive spheres are in contact, the convergence of the series upon which these formulæ depend is not rapid, and they must not be employed for very small distances. In this example the formulæ would be good for values of $v = 10$ or more. In figs. 9 and 10 the scale on the equatorial line gives the values of v .

More than two Atoms per Molecule.

It has been shown that there are at least two stable positions in which three atoms may come to equilibrium. The degree of stability differs in each case, and no attempt has yet been made to measure it, and to predict which arrangement would be the more likely to persist and withstand the shocks received

from other atoms ; but it is no doubt possible to do this. In showing these combinations it is to be understood that it is not stated that they represent the molecules of the compounds, but that they are some of the possible forms that may exist. If a third atom, similar to the second, is placed in the lower of the two equilibrium circles which accompany any single atom, the second atom being in the upper circle, the control by the central or first atom is very much greater than the influence which the second atom has upon the third atom, because the distance between the outside atoms is nearly double that between the central and outside atom, and the force varies not as the inverse square, but as a higher power of the distance. Calculation in the case of a central atom $13=9+4$, representing oxygen, and two outside atoms, each with a single ring of three electrons, representing hydrogen, shows that the angle of latitude is decreased only 3.5 minutes of arc, and the distance v is increased about three parts in 1000 by the presence of the third atom.

The central atom, however, exercises no control over the position of the outside atoms in their respective circles. The second and third atoms alone then determine their own positions in these circles. It is clear from the charts that the stable position must be such that the axes of the two outside atoms will be coincident ; for, at the distance of the two circles the along-force is an attraction, the distance between the atoms being greater than the critical distance $\beta v = \sqrt{5}$, and that the perpendicular force is zero and the position stable for small displacements ; for the distance between the atoms is also greater than the critical distance $\beta v = \sqrt{10}$, where the perpendicular curve of zero force intersects the axis. This gives a complete proof of the stability of this combination of three atoms.

Fig. 13 shows several molecules with two, three, four, and five atoms per molecule. The diatomic molecules are H_2 , C_2 , N_2 , O_2 , F_2 , CN , NO , and CO . These chemical symbols are intended to designate the atoms for which the combination of electrons in rings is given in Table III. In this figure hydrogen has been taken as a single ring of three electrons. The experimental results obtained by Thomson indicate that two or three is the correct number of electrons in the hydrogen atom. The diatomic molecule with atoms of only two electrons each has not yet been calculated for reasons given in another place, that this combination is not independent of the phase relation of the electrons, and a determination of it requires that the equations be carried out to the next order of approximation, including terms in v^{-8} .

There are certain reasons that make it not unlikely that the atom with only two electrons best represents hydrogen. Eventually all combinations should be calculated; but the labour involved has limited us to a few typical solutions. The angles of latitude are given in the figure, that for hydrogen being $65^{\circ} 50'$. The other diatomic molecules shown have angles ranging from $73^{\circ} 40'$ for carbon to $74^{\circ} 45'$ for fluorine, a small variation, but a small variation in this angle is very important in the property of forming compounds.

The three-atom molecules shown are drawn to the same scale as the two-atom molecules. They represent H_3 , C_3 , N_3 , O_3 , HCN , CO_2 , H_2O , N_2O , and HNO . The angles of latitude are a few minutes of arc less than the corresponding diatomic molecules.

If the third atom is located on the same side of the equator as the second atom, instead of on the opposite side, as in the above molecules, it is evident from fig. 9 that the second and third atoms repel each other with considerable force if they should remain in the equilibrium circle of the diatomic molecule; for the second atom is upon the equator of the third atom, and the distance between them is not so great as the distance to the central or first atom. These circles will no longer apply to these molecules, because the atoms separate from each other to a greater distance than the diameter of the circles, and the distance from the central atom also increases. The equations have been obtained by which the angles and distances may be found, and it has been proved in certain cases that the combination is stable; but no sketches are shown in fig. 13 as the particular angles and distances have not been calculated.

One case has been calculated with four atoms in the molecule: a ring of three hydrogen atoms with one nitrogen atom at the apex of the right cone of which the ring forms the base. This represents ammonia, NH_3 . The addition of a third atom in the ring rapidly increases the dimensions of the whole molecule, and consequently reduces the degree of stability possible. The distance between the nitrogen and the hydrogen atoms in this figure is $\beta v = 4.9$, as compared with $\beta v = 2.88$ in the diatomic molecule NH , and the angle of latitude is $64^{\circ} 31'$ as compared with $71^{\circ} 46'$. The distance between any two hydrogen atoms is $\beta v = 3.65$.

If a fourth atom is added to the ring, making a five-atom molecule, the equations show that for equilibrium the distances are very greatly increased. The combination of carbon with a ring of four hydrogen atoms has been

calculated, and illustrates the case. The distance between the carbon and hydrogen atoms is $\beta v = 13.75$, and between diametrically opposite hydrogen atoms, $\beta v = 15.08$. If nitrogen were substituted for the carbon with the four hydrogen atoms, the distances would be greater yet; and if oxygen or fluorine were substituted for the carbon, the distances rapidly increase for each change. This is due to the differences in these atoms which make the small differences in the angles of the diatomic molecules shown in the figures. Consequently the degree of stability is greater with carbon combined with four hydrogen atoms in a ring than it is with nitrogen so combined, and with nitrogen than with oxygen, and with oxygen than with fluorine.

The dimensions of this molecule from atom to atom seem to be too great for long continued existence as a compound molecule; but if two of the hydrogen atoms are removed from the upper and placed in the lower ring of the carbon atom, it is found that the distance between the carbon and hydrogen atoms is reduced from 13.75 to 6.85, which is almost exactly one-half of the former distance. The distance between the hydrogen atoms in the same ring is 6.3 as compared with 15.08 before. The two lower atoms take positions at right angles to the upper atoms, thus forming a tetrahedron, of four hydrogen atoms with one carbon atom at the centre. This is a much more stable arrangement than the preceding on account of the reduced distances. If nitrogen is substituted for carbon the dimensions all increase to a considerable extent, and the stability diminishes, as in the case of the ring of four atoms above. This combination represents the compound Methane or Marsh gas, perhaps the most fundamental of the very great family of hydrocarbon compounds. Special graphical methods of notation for this family are used in Chemistry, and it has been shown that there are compounds which demand that the lines of connexion between the different atoms must be represented by a geometrical figure in space instead of one in a plane. Such an atom as this in the tetrahedron form makes the reason for this peculiarity in the case of the carbon compounds apparent.

Ions.

It has been very difficult to reconcile the theory, at the present time much in vogue, that atoms easily gain or lose electrons, with the theory of the formation of the atoms by groups of electrons in stable equilibrium within the positive sphere. At one time it was supposed by many that there

were large numbers of electrons in each atom, and it was not a difficult matter to imagine that it might gain or lose one. This was because no explanation was given of the manner in which they were held within the atom itself. But, with smaller numbers, each electron makes itself distinctly felt in determining the characteristics of the atom. The supposition of the loss of electrons is made to confer upon the atom an electrical charge which is not neutralized or of zero value for the purpose of allowing the atom to be attracted or repelled, as they are observed to be in an ionized gas. The assumption seems to have been made by those advocating this theory, that because a normal atom is neutral, the total sum of its charges being zero, such an atom is not attracted or repelled by a free outside charge. The equations show that each neutral atom may be either attracted or repelled by an outside charge depending upon their relative positions, provided they are within molecular range of each other. The reason for this is due to the fact that it leads to a false conclusion, to assume that all the charge in an atom has an effect equivalent to that of the same charge situated at the centre of its sphere. The force is due solely to the electrostatic distribution of the charges within the atom, and not to their motion. The values of this force for the different atoms, both along and perpendicular to the line joining the centres of the atom and charge, have been calculated, and are given by (61) and (62) respectively. They show that a positive charge is attracted by any atom when situated on its equator, and is repelled when on its axis. At large distances there is an angle $36^{\circ} 18'$ of latitude at which the force changes sign, passing through a zero value. At the limits of molecular range the force varies as the inverse fourth power of the distance. With decreasing distance the force does not change sign, at least until the charge approaches very close to the atom. The equations in their present form unfortunately tell us nothing about the force close to the atom, since the series is not convergent, and what becomes of a charge drawn toward an atom, thus forming an ion, remains an unsolved problem.

*The Angular and Linear Velocities of the Electrons
within the Atoms.*

A determination of the angular velocity of the electrons within the atoms is much more certain than that of the linear velocity, according to this theory of the formation of

molecules. Denoting the angular velocity of the electron in the three-electron atom, which we may call hydrogen, by ω , the linear velocity by q , velocity of light by c , the radius of the orbit by a , the distance between the two atoms in the H_2 molecule by $r=av$, the ratio $q/c=\beta$, we have the evident relations

$$\beta = \frac{a\omega}{c}, \quad \beta v = \frac{r\omega}{c}, \quad \text{or } \omega = \frac{\beta v c}{r},$$

from which the wave-length of a wave travelling with the velocity of light, having the same period as the electrons in their orbits, and the frequency are found to be

$$\lambda = \frac{2\pi r}{\beta v} \quad \text{and} \quad n = \frac{\beta v c}{2\pi r}.$$

It has been shown that the product βv is nearly the same for all the diatomic molecules, being 2.66 for atoms with a single ring of three electrons. Hence the only factor in the wave-length or the frequency that is uncertain is the distance r between the two atoms. In round numbers it is usual to take the dimensions of a molecule as 10^{-8} cm., and this is the approximate value of r . This value of r makes the fundamental frequency of the electrons in their orbits 1270×10^{15} , and the wave-length 2.36×10^{-8} cm. Very short ultra-violet waves of light have a frequency and wave-length 1.5×10^{15} and 2000×10^{-8} respectively. The frequency of the electron is, therefore, 847 times greater than short ultra-violet waves, and the wave-length correspondingly shorter.

The size of the molecule, 10^{-8} , is obtained by one method from the kinetic theory of gases by considerations of the mean free paths of the molecules. It is quite conceivable that by this means larger values would be obtained than would be the case if we could directly measure the distance between the two atoms of the molecule. For the reasons above given that the parts of adjacent molecules should be considerably further apart than the atoms of the molecule itself, it seems probable that the separation between the two atoms of the diatomic molecule is somewhat less than 10^{-8} cm. If so, the wave-length computed above would be shorter still, and the frequency greater.

The wave-length and frequency of the X-rays has recently been measured, or computed from measurements of the diffraction patterns obtained from crystals*, to be from $\lambda = 1.27$ to 4.83×10^{-9} cm. and $n = 2.36$ to $.621 \times 10^{19}$ cm.

* Laue, Friedrich, and Knipping, *Münch. Ber.* pp. 303-322 (1912).

This is from 18.6 to 4.9 times shorter than the *calculated* wave emitted by the fundamental period of the electrons in the atom, and the difference would be less still if the distance between the two atoms of the molecule is less than 10^{-8} cm.

Linear Velocity.—It must be said that no definite result has yet been reached in determining the linear velocity of the electron in the atom, except that it seems to be small compared with that of light. There are at least two modes of inquiry; first, by means of the spectra. If the atoms described represent true atoms it should be possible to account for the various spectra of the elements and their compounds. Whittaker* has in a very general manner derived the law of the hydrogen series, and has shown that the only kind of terms in the general equations that can account for such a law are those that arise from a gyroscopic connexion between the atoms of a molecule. The molecules indicated by this theory are simply little gyroscopes connected in a semi-rigid manner. It seems as though it might be possible to derive the law of the hydrogen series in this manner, and the subject is referred to here in the hope that some one will undertake these calculations. If successful, not only will the spectra be derived, but the linear velocity, and the relative size of atom and distance between them be found. It will also be possible to decide whether hydrogen has two or three electrons per atom.

Second, the linear velocity might be derived from the heats of combination of the elements and compounds. Attempts have been made to do this, but the results are not entirely conclusive for the following reasons. It should be possible to calculate the energy required to separate the atoms of a molecule on this theory of the formation of molecules. The difficulty is that the energy comes out a different quantity according to the path along which the atom is moved from any fixed position to infinity. That is to say, the energy in going around a closed path is not zero apparently. No doubt this is due to some difficulty in calculating the energy, possibly the alteration of the internal phase of the electrons with the motion from point to point which has been neglected, or to some other causes.

If one of the atoms in the diatomic molecule (three electrons) is separated from the other along the line joining their centres when in the position of stable equilibrium, the

* E. T. Whittaker, Proc. Roy. Soc. ser. A. vol. lxxxv. no. A 578, June 9, 1911, p. 262.

total work required is shown to be $E = .0716 \frac{e^2}{a^2} \beta^5$. The energy of dissociation* of one gram of hydrogen at constant pressure has been measured to be 136,000 calories, that is, 569×10^{10} ergs. From this the energy of dissociation of one molecule of hydrogen is found to be 25.6×10^{-12} erg. By equating the calculated and the measured energy, we obtain the relation

$$\beta^3 = \frac{25.6 \times 10^{-12}}{.0716} \frac{c^2}{e^2 \omega^2} = .0254 \times 10^{-18}.$$

In using $r = 10^{-8}$ as the dimensions of the molecule we obtain from this $\beta = .00281$; $a = 1.057 \times 10^{-11}$ cm.; $v = 947$, and $q = 8.43 \times 10^7$ cm. per sec. If however, we assume that the longest X-rays, given above, have substantially the same period as the electrons in their orbits, this condition is obtained by assuming that the distance between the atoms of the molecule is about five times smaller, namely, $r = 2 \times 10^{-9}$ cm., from which we find $\beta = .00096$; $a = .72 \times 10^{-12}$ cm.; $v = 2770$, and $q = 2.89 \times 10^7$ cm. per sec.

$$\lambda = 4.83 \times 10^{-9}; \quad n = .621 \times 10^{19}; \quad \omega = 3.9 \times 10^{19}.$$

It seems clear that we do not need to assume velocities for the electrons approaching that of light to account for the formation of molecules by this theory. Also, the dimensions of the atoms are indicated to be much smaller than molecular dimensions, probably nearer to the size of an electron than to that of a molecule. The radius of the electron has been calculated to be about 1.8×10^{-13} cm., and the smaller value of the radius of the ring of electrons in the three-ring atom above is less than ten times the radius of the electron.

Phase Relations.

The equations (45) and (46) which determine the equilibrium positions of the atoms in a molecule are independent of the phase angle, γ , which the electrons make with each other. This is merely because we are satisfied with this degree of approximation. If the terms in v^{-8} are included, some of these terms would depend upon the phase angle. The forces resolved along the tangent to the orbit at the position of the electron are given by (57) to (60). By these equations it has been shown that in the case of two atoms with three electrons each the phase relation of the electrons for equilibrium, if the one atom were on the axis of the

* Langmuir, Am. Chem. Soc. Jour. xxxiv. pp. 860-877, July 1912.

other, would be such that each electron in the one stands half-way between those in the other atom; while in the stable position of the two atoms at an angle of latitude $65^{\circ} 50'$, they stand exactly in phase with each other.

The fact that the approximate equations (45) and (46) are independent of this phase angle has an important significance. It means that one ring of electrons may advance ahead of or become retarded behind the other without altering the approximate positions of the atoms relatively to each other. If the transmission of the force from the one atom to the other requires a certain time, instead of being instantaneously transmitted as these equations assume, the electrons in the rings would occupy a different phase position according to the time of transmission; but if the equilibrium position is independent of the phase relation, it is not unreasonable to suppose that approximately the same positions would be obtained had the more complex equations involving transmission at the velocity of light been employed.

Atoms at a great distance from each other.

When the distance between the atoms is very great, as in astronomical problems, the equations are very much simplified. It is shown that the electrostatic forces give a zero resultant between two atoms, if those terms only are admitted which give the law of the inverse square of the distance; but that the second component force, due to the motion of the electrons, gives a term varying as the inverse square of the distance, provided only that the angular velocities of the electrons are assumed to be equal. For incommensurable velocities the principal term of the force varies as the inverse fourth power of the distance. Equation (65) gives the complete expression for the force between two electrons varying as the inverse square of the distance, revolving in true circles inclined at any angle, α , to each other, and at great distances apart, if the rotation is synchronous. It is seen that the force may be an attraction or a repulsion according to the sign of $\cos \gamma$. If this force is summed for every combination of electrons in two masses of matter, the result appears to be zero. This summation is difficult to make, however, for it must be done with such accuracy that it is correct to almost one part in 10^{36} . This number is the approximate ratio of the total unbalanced force between all the electrons in a gram of matter to the very small gravitational attraction between them. It is also difficult to show that if there were any residual force, it would be an attraction and not a repulsion. The true motion of the

electrons in the molecules must depart somewhat from a circle, as has been shown; and whether or not any terms may be found due to the gyroscopic motions of the atoms that will give rise to a force varying as the inverse square of the distance is worth investigating. The only way as yet found to obtain terms with the inverse square of the distance is by the assumption of synchronous revolution of the electrons at a great distance apart. The probabilities against such synchronous motions are very great, but it is different at molecular distances when a rigid connexion has been established between the atoms of a molecule.

PART III.

Let e and e' denote two electrical charges moving with velocities q and q' , and accelerations \dot{q} and \dot{q}' respectively. Let the distance between them be R at the time t , and the angle between their directions of motion be γ , then the mechanical force which the second charge, e' , exerts upon the first charge, e , at the instant t , is expressed as a vector sum of four component vectors :

$$F_1 = \frac{ee'}{KR^2}, \quad \dots \quad \text{a repulsion along the line joining} \\ \text{the centres of the charges.} \quad \dots \quad (1)$$

$$F_2 = \frac{\mu ee'}{R^2} qq' \cos \gamma, \quad \dots \quad \text{an attraction along the line joining} \\ \text{the centres of the charges} \quad \dots \quad (2)$$

$$F_3 = \frac{\mu ee'}{R} \dot{q}', \quad \dots \quad \text{a force in a direction opposite to} \\ \text{the acceleration of the second} \\ \text{charge} \quad \dots \quad (3)$$

$$F_4 = \mu ee' q' \frac{d}{dt} \left(\frac{1}{R} \right), \quad \dots \quad \text{a force in a direction opposite to} \\ \text{the direction of motion of the} \\ \text{second charge} \quad \dots \quad (4)$$

These equations will now be applied to the case where each of the charges e and e' is revolving at uniform angular velocities ω and ω' in circular orbits of radii a and a' respectively. The orbits are situated in the most general position, the two axes of rotation having an angle α between their directions, and the distance, r , between the centres of the two orbits being any value large or small. Select two systems of rectangular axes, i, j , and k , and i', j' , and k' , these letters representing unit vectors along their respective directions, the first set of axes referring to the charge e and

the second to e' . Let the k - and k' -axes take the directions of the axes of rotation of e and e' respectively, making an angle α with each other. The i - and j -axes will, therefore, lie in the plane of the orbit of e , and i' - and j' -axes in a plane parallel to the orbit of e' . Since the planes of the two orbits in general intersect in some line, this direction may be chosen for the direction of the j - and j' -axes, and the prime may be suppressed. This line of intersection is perpendicular to both the k - and k' -axes, and the positive direction along the j -axis may be defined as the vector $k \times k'$. The angle between the i - and i' -axes is, therefore, α , and that between the i' - and k -axes is the complement of α .

It is required to find the total average translational force exerted by the second charge e' upon the charge e , when averaged over a long period of time on the assumption that the positions of the orbits remain unchanged during this time. This average force will be found by resolving the instantaneous forces along certain selected directions and averaging them in these directions. It is convenient in referring to an atom to speak of its axis, equator, which is the plane of the orbit, and a meridian plane, and circle of latitude, as we refer to the earth. The three directions chosen for resolving all forces are, first, along the line joining the centres of the orbits, and, second, perpendicular to this direction in the plane of the meridian of e , and, third, along a small circle of latitude. It will be shown that the average force in the latter direction is always zero, so that there are only two directions in which the force must be calculated to obtain the total force.

Let the position of the charge, e , in its orbit be defined by the equation (5), and of e' by (6), where \mathbf{r}_1 and \mathbf{r}_2 are the vectors from the centres of their orbits to the charges e and e' respectively.

$$\mathbf{r}_1 = [a \sin(\omega t + \theta)] i + [a \cos(\omega t + \theta)] j, \quad \dots \quad (5)$$

$$\mathbf{r}_2 = [a' \sin(\omega' t + \theta')] i' + [a' \cos(\omega' t + \theta')] j. \quad \dots \quad (6)$$

Let \mathbf{r} denote the constant vector from the centre of the orbit of e to that of e' , having the components x , y , and z referred to the i -, j -, and k -axes, whence

$$\mathbf{r} = xi + yj + zk \quad \dots \quad (7)$$

The vector \mathbf{R} , from the charge e to the charge e' , is, therefore,

$$\mathbf{R} = -\mathbf{r}_1 + \mathbf{r} + \mathbf{r}_2 \quad \dots \quad (8)$$

60 Dr. A. C. Crehore on the Formation of the
and, by addition, we find

$$\mathbf{R} = A\mathbf{i} + B\mathbf{j} + C\mathbf{k} + D\mathbf{i}' \dots \dots \dots (9)$$

where

$$A = x - a \sin(\omega t + \theta),$$

$$B = y - a \cos(\omega t + \theta) + a' \cos(\omega' t + \theta'),$$

$$C = z,$$

$$D = a' \sin(\omega' t + \theta').$$

To obtain the magnitude of \mathbf{R} , namely R , take the direct product $\mathbf{R} \cdot \mathbf{R}$ from (9), and find

$$R^2 = A^2 + B^2 + C^2 + D^2 + 2AD \cos \alpha + 2CD \sin \alpha \dots (10)$$

Upon substituting the values of A , B , &c., in (10), we obtain the value of R^2 as a function of the time, which is true for any distance, r , between the centres of orbits, and for any inclination, α , of the axes of rotation.

$$R^2 = s^2(1 + u) \dots \dots \dots (11)$$

$$u = \frac{2}{s^2} \left[-ax \sin(\omega t + \theta) - ay \cos(\omega t + \theta) + a'z \sin \alpha \sin(\omega' t + \theta') \right. \\ \left. + a'y \cos(\omega' t + \theta') + a'x \cos \alpha \sin(\omega' t + \theta') \right. \\ \left. - aa' \cos \alpha \sin(\omega t + \theta) \sin(\omega' t + \theta') - aa' \cos(\omega t + \theta) \cos(\omega' t + \theta') \right] \dots \dots \dots (12)$$

where $s^2 = x^2 + y^2 + z^2 + a^2 + a'^2 = r^2 + a^2 + a'^2$, a constant $\dots \dots \dots (13)$

The value of R^2 is put in this form for convenience in expansion, as we shall require R^{-3} in obtaining the first and second component forces. The first component force (1) is the electrostatic repulsion of the charge e' upon that of e , and it acts in the direction $e'e$, or $-\mathbf{R}$. To resolve this force along the direction $O'O$, or $-\mathbf{r}$, the line joining the centres of the orbits, multiply F_1 by the cosine of the angle between \mathbf{R} and \mathbf{r} . The cosine of this angle is obtained from the direct product of \mathbf{R} and \mathbf{r} , and is equal to $\frac{\mathbf{R} \cdot \mathbf{r}}{Rr}$. Hence

$$F_1 = -\frac{ee'}{K\gamma^2 R^3} (\mathbf{R} \cdot \mathbf{r}) \mathbf{r} \dots \dots \dots (14)$$

The value of $\mathbf{R} \cdot \mathbf{r}$ may be obtained from (7) and (9), whence

$$\mathbf{R} \cdot \mathbf{r} = Ax + By + Cz + xD \cos \alpha + zD \sin \alpha \dots (15)$$

or, substituting the values of A, &c.,

$$\mathbf{R} \cdot \mathbf{r} = r^2 - ax \sin(\omega t + \theta) - ay \cos(\omega t + \theta) + a'z \sin \alpha \sin(\omega' t + \theta') + a'y \cos(\omega' t + \theta') + a'x \cos \alpha \sin(\omega' t + \theta') \dots \dots \dots (16)$$

By (11) we find

$$R^{-3} = s^{-3}(1+u)^{-3} = \frac{1}{s^3} \left(1 - \frac{3}{2}u + \frac{15}{8}u^2 - \frac{35}{16}u^3 + \frac{315}{128}u^4 - \frac{693}{256}u^5 + \dots \right) \dots \dots (17)$$

Upon substitution of (17) and (16) in (14), the complete value of F_1 when resolved along the vector \mathbf{r} , from O to O', becomes

$$F_1 = \frac{-ee'}{Ks^3r^2} \left[r^2 - ax \sin(\omega t + \theta) - ay \cos(\omega t + \theta) + a'z \sin \alpha \sin(\omega' t + \theta') + a'y \cos(\omega' t + \theta') + a'x \cos \alpha \sin(\omega' t + \theta') \right] \left[1 - \frac{3}{2}u + \frac{15}{8}u^2 - \frac{35}{16}u^3 + \frac{315}{128}u^4 - \dots \right] \mathbf{r} \dots \dots \dots (18)$$

The Second Component Force resolved along the direction r.

The value of the second component of the force (2) has the same form as the first component, or electrostatic force, except for the factor $qq' \cos \gamma$. If \mathbf{q} and \mathbf{q}' denote the vector velocities, this factor is $\mathbf{q} \cdot \mathbf{q}'$, and may be obtained by differentiating (5) and (6), and then taking the direct product. The differentials of \mathbf{r}_1 and \mathbf{r}_2 with respect to the time are

$$\mathbf{q} = \frac{d\mathbf{r}_1}{dt} = a\omega \left\{ [\cos(\omega t + \theta)](i) - [\sin(\omega t + \theta)](j) \right\} \dots (19)$$

$$\mathbf{q}' = \frac{d\mathbf{r}_2}{dt} = a'\omega' \left\{ [\cos(\omega' t + \theta')](i') - [\sin(\omega' t + \theta')](j) \right\} \dots (20)$$

and their direct product

$$\mathbf{q} \cdot \mathbf{q}' = aa'\omega\omega' [\cos \alpha \cos(\omega t + \theta) \cos(\omega' t + \theta') + \sin(\omega t + \theta) \sin(\omega' t + \theta')] \dots \dots \dots (21)$$

The second component force (2) when resolved along the vector, \mathbf{r} , is therefore,

$$F_2 = \frac{ee'}{r^2R^3} (\mathbf{R} \cdot \mathbf{r})(\mathbf{q} \cdot \mathbf{q}') \mathbf{r} \dots \dots \dots (22)$$

The complete value of the second component force resolved along \mathbf{r} is, then, denoting for brevity $S = \sin(\omega t + \theta)$; $S' = \sin(\omega' t + \theta')$; $C = \cos(\omega t + \theta)$; $C' = \cos(\omega' t + \theta')$,

$$F_2 = \frac{\mu e e' a a' \omega \omega'}{r^2 s^3} \left[C C' \cos \alpha + S S' \right] \left[r^2 - a x S - a y C + a' z S' \sin \alpha + a' y C' + a' x S' \cos \alpha \right] \left[1 + u \right]^{-\frac{3}{2}} \mathbf{r} \dots \dots \dots (23)$$

Average Values of the Forces.

To obtain the average force of the charge e' upon e , each describing circular orbits in any fixed position, the first component (18) and the second (23) will be averaged separately over a long time.

$$\bar{F}_1 = \frac{\int_0^\infty F_1 dt}{\int_0^\infty dt = T} \quad \bar{F}_2 = \frac{\int_0^\infty F_2 dt}{\int_0^\infty dt = T}$$

The values of these integrals depend upon the assumptions made concerning the relative angular velocities, ω and ω' , of the two electrons. If the angular velocities are the same, or some exact multiple of each other, there is a particular solution for that case. When two atoms unite to form a molecule there is a tendency to synchronize the periods of revolution in their orbits if they are not very different originally, and on this account the solution when the angular velocities are exactly equal takes on an added importance. The average forces in the general position of the orbits become involved expressions when higher powers of u are considered, and for this reason are not so useful, but since they have been obtained for the particular case of equal angular velocities, and including the first, but not the second and higher powers of u , and will be useful in certain instances, they are given here. The first component is

$$\bar{F}_1 = - \frac{e e'}{K s^3 r} \left[r^2 - \frac{3}{2 s^2} F + \frac{3 a a'}{2 s^2} \left(G \cos \gamma + H \sin \gamma \right) \right] \dots \dots (24)$$

where

$$F = a^2(x^2 + y^2) + a'^2 y^2 + a'^2(z \sin \alpha + x \sin \alpha)^2,$$

$$G = r^2 + 2y^2 + (r^2 + 2x^2) \cos \alpha + 2xz \sin \alpha,$$

$$H = -2xy + 2xy \cos \alpha + 2yz \sin \alpha.$$

And the second component is

$$\bar{F}_2 = \frac{\mu e e' a a' \omega^2}{r s^3} \left\{ \frac{3 a a'}{8 s^2} A + \left[\frac{r^2}{2} (1 + \cos \alpha) - \frac{3}{8 s^2} B \right] \cos \gamma \right. \\ \left. + \frac{3 a a'}{4 s^2} C \cos^2 \gamma + \frac{3}{8 s^2} D \sin \gamma + \frac{3 \lambda a'}{8 s^2} E \sin 2 \gamma \right\} \quad (25)$$

where

$$A = -(r^2 + 2y^2) + 2(r^2 + x^2 + y^2) \cos \alpha + 2xz \sin \alpha \\ - (r^2 + 2x^2) \cos^2 \alpha - 2xz \sin \alpha \cos \alpha, \\ B = 3a^2x^2 + a^2y^2 + a'^2y^2 + (a^2x^2 + 3a^2y^2 + 3a'^2y^2) \cos \alpha \\ + 6a'^2xz \sin \alpha \cos \alpha + 3a'^2x^2 \cos^2 \alpha + 2a'^2xz \sin \alpha \cos^2 \alpha \\ + a'^2x^2 \cos^3 \alpha + a'^2z^2 \sin^2 \alpha \cos \alpha + 3a'^2z^2 \sin^2 \alpha, \\ C = r^2 + 2y^2 + 2(r^2 + x^2 + y^2) \cos \alpha + 2xz \sin \alpha \\ + (r^2 + 2x^2) \cos^2 \alpha + 2xz \sin \alpha \cos \alpha, \\ D = -2a^2xy + 2xy(a^2 + a'^2) \cos \alpha + 2a'^2yz \sin \alpha \\ - 2a'^2xy \cos^2 \alpha - 2a'^2yz \sin \alpha \cos \alpha, \\ E = 2xy - 4xy \cos \alpha - 2yz \sin \alpha + 2yz \sin \alpha \cos \alpha + 2xy \cos^2 \alpha.$$

The Third and Fourth Component Forces.

It will now be shown that the sum of the third and the fourth component forces when averaged over a long time is zero under any conditions of the motion of the charges. The consequence is that the translational force due to these component forces is always zero upon any atom containing a number of revolving electrons, and need not be considered further. The instantaneous values of course do not vanish, but as far as the equilibrium positions of the atoms are concerned they may be completely determined by considering the first and second component forces alone. The effects of the third and fourth component forces are felt in the atoms because the moments of the forces do not vanish, and they control the position of the plane of the orbit, and of the individual electrons within the orbits, thereby conferring a certain rigidity upon the whole system.

The third and fourth component instantaneous forces expressed as vectors are

$$F_3 = -\frac{\mu e e'}{R} \dot{\mathbf{q}}', \\ F_4 = -\mu e e' \left(\frac{d}{dt} \left(\frac{1}{R} \right) \right) \mathbf{q}'.$$

Taking the average value of the sum of these forces integrated between the limits 0 and ∞ , we have

$$\int_0^{\infty} F_4 dt = \int_0^{\infty} \left[-\frac{\mu ee'}{R} \dot{q}' + \int \frac{\mu ee'}{R} \dot{q}' dt \right] = \int_0^{\infty} \frac{\mu ee'}{R} \dot{q}' dt = -\int_0^{\infty} F_3 dt.$$

$$\text{Hence } \bar{F} = \frac{1}{T} \int_0^{\infty} (F_3 + F_4) dt = 0.$$

These forces will be considered again when obtaining an expression for the moments of the forces within an atom.

Case where the Two Axes of Rotation are Parallel.

When the axes of rotation and the planes of the orbits of the two electrons, or electrical charges under consideration, are parallel, there is no component of the third and fourth forces perpendicular to the plane, since these forces are parallel to the acceleration and velocity of the second charge, each of which lies in the plane of its orbit. A small displacement from parallelism brings to bear forces tending to restore the planes to parallelism and producing at the same time a gyroscopic motion. When the atoms, of which the two electrons now being considered are constituents, are in equilibrium with each other forming a molecule, the first and second component forces on the average balance each other, and it is thought that the control of the position of the plane and axis in this situation is by the third and fourth components. These, as just mentioned, tend to bring the axes into parallelism, and hold them parallel.

From these considerations it is thought that the case of parallel axes of rotation is most important. A very great simplification is introduced in the general equations by making this supposition, and it has been possible, by first working out special cases and later generalizing the formulæ, to obtain a complete solution to any desired power of u , as the law of the series has been determined.

In the case of parallel axes of rotation the angle α is zero, and by assuming that the centre of the second orbit is situated in the $i-k$, that is, the $x-z$ plane, none of the generality of treatment is lost. With these substitutions the value of u in (12) becomes, putting $\theta' - \theta = \gamma$,

$$u = \frac{2}{s^2} \left[-axS + a'xS' - aa' \cos \gamma \right]. \quad \dots \quad (26)$$

and the value of $\mathbf{q} \cdot \mathbf{q}'$ in (21) reduces to a constant value if the angular velocities ω and ω' are equal.

$$\mathbf{q} \cdot \mathbf{q}' = aa' \omega^2 \cos \gamma \quad \dots \quad (27)$$

The instantaneous force F_1 , resolved along the vector \mathbf{r} , becomes from (18)

$$F_1 = -\frac{ee'}{Ks^3r^2} [r^2 - axS + a'xS'] [1 + u]^{-\frac{1}{2}} \mathbf{r} . . \quad (28)$$

When the angular velocities are equal, the second component force (2) is easily expressed in terms of the first component, and we have

$$\begin{aligned} F_2 &= \frac{\mu ee'}{R^3} (\mathbf{q} \cdot \mathbf{q}') \mathbf{R} = \frac{ee'}{Kc^2 R^3} (\mathbf{q} \cdot \mathbf{q}') \mathbf{R} = -F_1 \frac{(\mathbf{q} \cdot \mathbf{q}')}{c^2} \\ &= -F_1 \frac{aa'\omega^2 \cos \gamma}{c^2} = -F_1 \beta \beta' \cos \gamma, . \quad (29) \end{aligned}$$

where c = velocity of light, and

$$\beta = \frac{q}{c} = \frac{a\omega}{c}; \quad \beta' = \frac{q'}{c} = \frac{a'\omega}{c}.$$

Because of this relation the second component force resolved along any desired direction and averaged over a long period is easily found from the first component.

The Perpendicular Component of F_1 .

To find the force resolved along the perpendicular to \mathbf{r} in the meridian plane and in the direction towards the axis of rotation, it is seen that the vector $\mathbf{j} \times \mathbf{r}$ takes the direction of this perpendicular. By (7) we have in this case

$$\mathbf{r} = xi + zk. \quad (30)$$

Hence $\mathbf{j} \times \mathbf{r} = zi - xk. \quad (31)$

The cosine of the angle between the vector \mathbf{R} , along which the force acts, and the vector $\mathbf{j} \times \mathbf{r}$, along which we desire to resolve the force, is

$$\frac{\mathbf{R} \cdot \mathbf{j} \times \mathbf{r}}{rR} = \frac{z}{rR} [a'S' - aS]. . . . \quad (32)$$

The first component force resolved along $\mathbf{j} \times \mathbf{r}$ is, therefore,

$$F_1 = \frac{ee' \sin \lambda}{KR^3} (a'S' - aS), \text{ where } \sin \lambda = \frac{z}{r}. . \quad (33)$$

Average Values.

The average values of the forces along and perpendicular to \mathbf{r} are obtained from (28) and (33) respectively by integration, and we find, putting $r=av$; $a=ma_*$; $a'=na_*$; and $\Delta=(v^2+m^2+n^2)^{-\frac{1}{2}}$ and including all terms in v^{-6} ,

$$\begin{aligned} \overline{F}_1 = -\frac{e^2 r \Delta^3}{K a_*^2} \left\{ 1 + 3mn(\cos \gamma) \Delta^2 + 7 \cdot 5 m^2 n^2 (\cos^2 \gamma) \Delta^4 + 3 \cdot 75 (m^2 + n^2) \right. \\ \left. - 2mn \cos \gamma (\cos^2 \lambda) v^2 \Delta^4 + 26 \cdot 25 mn \cos \gamma (m^2 + n^2) \right. \\ \left. - 2mn \cos \gamma (\cos^2 \lambda) v^2 \Delta^6 + 14 \cdot 7656 (m^2 + n^2) \right. \\ \left. - 2mn \cos \gamma)^2 (\cos^4 \lambda) v^4 \Delta^8 - 1 \cdot 5 (m^2 + n^2 - 2mn \cos \gamma) \right. \\ \left. (\cos^2 \lambda) \Delta^2 - 5mn \cos \gamma (m^2 + n^2 - 2mn \cos \gamma) (\cos^2 \lambda) \Delta^4 \right. \\ \left. - 875 (m^2 + n^2 - 2mn \cos \gamma)^2 (\cos^4 \lambda) v^2 \Delta^6 + \dots \right\}. \quad (34) \end{aligned}$$

$$\overline{F}_2 = -\beta \beta' (\cos \gamma) \overline{F}_1. \quad (35)$$

$$\overline{F}_1 = (\tan \lambda) \frac{e^2 v \Delta^3}{K a_*^2} \left\{ 1 \cdot 5 (m^2 + n^2 - 2mn \cos \gamma) (\cos^2 \lambda) \Delta^2 + 5mn \cos \gamma (m^2 + n^2) \right. \\ \left. - 2mn \cos \gamma (\cos^2 \lambda) \Delta^4 + 875 (m^2 + n^2) \right. \\ \left. - 2mn \cos \gamma)^2 (\cos^4 \lambda) v^2 \Delta^6 + \dots \right\}. \quad (36)$$

$$\overline{F}_2 = -\beta \beta' (\cos \gamma) \overline{F}_1. \quad (37)$$

Equations (34) to (37) give the average values of the first and second component forces resolved along and perpendicular to \mathbf{r} in the meridian plane, but it remains to be shown that the force perpendicular to both of these directions, namely, along a tangent line to the circle of latitude at the point where the second orbit is situated, is zero, and consequently that the forces above given are sufficient to determine equilibrium conditions. The direction along which we are to resolve the forces is parallel to the j -axis, and the cosine of the angle between \mathbf{R} , along which the force acts, and the j -axis, along which we are to resolve it, is $\frac{\mathbf{R} \cdot j}{R}$. By (9) when $y=0$, we find that

$$\frac{\mathbf{R} \cdot j}{R} = \frac{B}{R} = \frac{-aC + a'C'}{R}.$$

Hence, by (1)

$$\frac{F_1}{\text{Lat.}} = \frac{ee'}{KR^3} B = \frac{ee'}{Ks^3} (-aC + a'C') (1+u)^{-\frac{3}{2}} \dots \quad (38)$$

The integral $\int F_1 dt$ between the limits zero and infinity can be shown to be zero.

General Expressions for Average Forces.

The above equations (34) to (37) are sufficiently approximate for general use, as they include the fourth power of u in the development of $(1+u)^{-\frac{3}{2}}$, as far as those terms are concerned which contribute anything to v^4 and v^6 . v^8 is not included. In some cases it is desirable to include more terms for a closer approximation, and the following method makes it possible to write out the average forces along and perpendicular to r to any power of u .

Let $T = a \sin(\omega t + \theta) - a' \sin(\omega t + \theta') = aS - a'S' \quad (39)$

Then, from (28), the average value of the first component resolved along r is

$$\begin{aligned} \overline{F_1}_{\text{along } r} = \lim_{t \rightarrow \infty} \frac{1}{t} \int_0^t - \frac{ee'}{Ks^3 r} (r^2 - xT) & \left[1 + \frac{3}{2} \cdot \frac{2}{s^2} (aa' \cos \gamma + xT) \right. \\ & + \frac{3}{2} \cdot \frac{5}{4} \cdot \frac{2^2}{s^4} \left(\begin{array}{c} \text{''} \\ \text{''} \end{array} \right)^2 \\ & \left. + \frac{3}{2} \cdot \frac{5}{4} \cdot \frac{7}{6} \cdot \frac{2^3}{s^6} \left(\begin{array}{c} \text{''} \\ \text{''} \end{array} \right)^3 \dots \right] dt. \quad (40) \end{aligned}$$

Calculation shows that $\lim_{t \rightarrow \infty} \frac{1}{t} \int_0^t T^n dt = 0$ if n is odd.

If n is even, we find the following:—

$$\begin{aligned} \lim_{t \rightarrow \infty} \frac{1}{t} \int_0^t T^0 dt &= a_0 = 1, \\ \text{,, } T^2 dt &= a_2 g \quad \text{where } g = a^2 + a'^2 - 2aa' \cos \gamma \\ \text{,, } T^4 dt &= a_4 g^2 \quad \text{and } a_{2n} = \frac{2n-1}{2n} a_{2n-2}. \\ \text{,, } T^6 dt &= a_6 g^3 \\ \text{,, } T^8 dt &= a_8 g^4 \\ &\dots \dots \dots \\ \text{,, } T^{2n} dt &= a_{2n} g^n. \end{aligned}$$

described in (41), we find the value of

$$\begin{aligned}
 \overline{F}_1 \text{ Along } \mathbf{r} &= - \frac{\rho^2 \Delta^3 r}{K \mu^{*2}} \\
 &\left[\begin{array}{l}
 \Delta_{0,0} \delta \Gamma \Delta^2 + \\
 \Delta_{2,0} \delta^2 \Gamma^2 \Delta^4 + A_{4,2} \quad g^2 \Lambda^2 v^2 \Delta^4 \\
 \Delta_{4,0} \delta^3 \Gamma^3 \Delta^6 + A_{6,2} \delta \Gamma^1 g \Lambda^2 v^2 \Delta^6 \\
 \Delta_{6,0} \delta^4 \Gamma^4 \Delta^8 + A_{8,2} \delta^2 \Gamma^2 g \Lambda^2 v^2 \Delta^8 + A_{8,4} \quad g^2 \Lambda^4 v^4 \Delta^8 \\
 \Delta_{10,0} \delta^5 \Gamma^5 \Delta_{10} + \Delta_{10,2} \delta^3 \Gamma^3 g \Lambda^2 v^2 \Delta_{10} + \Delta_{10,4} \delta \Gamma^1 g^2 \Lambda^4 v^4 \Delta_{10} \\
 \Delta_{12,0} \delta^6 \Gamma^6 \Delta_{12} + \Delta_{12,2} \delta^4 \Gamma^4 g \Lambda^2 v^2 \Delta_{12} + \Delta_{12,4} \delta^2 \Gamma^2 g^2 \Lambda^4 v^4 \Delta_{12} + \Delta_{12,6} \dots g^3 \Lambda^6 v^6 \Delta_{12} \\
 \dots \dots \dots
 \end{array} \right] \\
 &- \left[\begin{array}{l}
 B_{2,2} \quad g \Lambda^2 \Delta^2 \\
 B_{4,2} \delta \Gamma \quad \Delta^4 \\
 B_{6,2} \delta^2 \Gamma^2 \quad \Delta_6 + B_{6,4} \quad g^2 \Lambda^4 v^2 \Delta_6 \\
 B_{8,2} \delta^3 \Gamma^3 \quad \Delta_8 + B_{8,4} \delta \Gamma \quad \Delta_8 \\
 B_{10,2} \delta^4 \Gamma^4 \quad \Delta_{10} + B_{10,4} \delta^2 \Gamma^2 \quad \Delta_{10} + B_{10,6} \dots g^3 \Lambda^6 v^4 \Delta_{10} \\
 \dots \dots \dots
 \end{array} \right] \dots \dots \dots \quad (42)
 \end{aligned}$$

Where the numerical coefficients are related as follows:—

$$\begin{aligned}
 A_{0,0} &= 1 \\
 A_{2,0} &= 3 A_{0,0} \\
 A_{4,0} &= \frac{5}{2} A_{2,0} & A_{4,2} &= \frac{1}{2} A_{4,0} \\
 A_{6,0} &= \frac{7}{3} A_{4,0} & A_{6,2} &= 7 A_{4,2} \\
 A_{8,0} &= \frac{9}{4} A_{6,0} & A_{8,2} &= \frac{9}{2} A_{6,2} & A_{8,4} &= \frac{1}{2} \times \frac{3}{4} A_{8,0} \\
 A_{10,0} &= \frac{11}{5} A_{8,0} & A_{10,2} &= \frac{11}{3} A_{8,2} & A_{10,4} &= 11 A_{8,4} \\
 A_{12,0} &= \frac{13}{6} A_{10,0} & A_{12,2} &= \frac{13}{4} A_{10,2} & A_{12,4} &= \frac{13}{2} A_{10,4} & A_{12,6} &= \frac{1}{2} \cdot \frac{3}{4} \cdot \frac{5}{6} A_{12,0}
 \end{aligned}$$

$$\begin{aligned}
 B_{2,2} &= \frac{3}{2} \\
 B_{4,2} &= \frac{5}{5} \\
 B_{6,2} &= \frac{7}{2} & B_{6,4} &= \frac{1}{4} B_{6,2} \\
 B_{8,2} &= \frac{9}{3} & B_{8,4} &= 9 B_{6,4} \\
 B_{10,2} &= \frac{11}{4} & B_{10,4} &= \frac{11}{2} B_{8,4} & B_{10,6} &= \frac{3}{4} \cdot \frac{1}{6} B_{10,2} \\
 B_{12,2} &= \frac{13}{5} & B_{12,4} &= \frac{13}{3} B_{10,4} & B_{12,6} &= 13 B_{10,6} \\
 B_{14,2} &= \frac{15}{6} & B_{14,4} &= \frac{15}{4} B_{12,4} & B_{14,6} &= \frac{15}{2} B_{12,6} & B_{14,8} &= \frac{3}{4} \cdot \frac{5}{6} \cdot \frac{1}{8} B_{14,2}
 \end{aligned}$$

The Average Force perpendicular to r.

From (33) we find the average value of the first component force resolved in the meridian plane perpendicular to **r** to be

$$\bar{F}_{\text{perp. r}} = \lim_{t \rightarrow \infty} \frac{1}{t} \int_0^t - \frac{ee'}{Ks^3} \sin \lambda [-T] \left[1 + \frac{3}{2} \cdot \frac{2}{s^2} (aa' \cos \gamma + xT) \right] dt \tag{43}$$

Upon comparing this with the equation (40) it may be shown that

$$\bar{F}_1 = \tan \lambda \frac{e^2 \Delta^3 v}{K a^{*2}} \left[\begin{array}{l} B_{2,2} \quad g \Lambda^2 \Delta^2 \\ B_{4,2} \delta \Gamma \quad \text{,, ,} \Delta^4 \\ B_{6,2} \delta^2 \Gamma^2 \quad \text{,, ,} \Delta^6 + B_{6,4} \quad g^2 \Lambda^4 v^2 \Delta^6 \\ B_{8,2} \delta^3 \Gamma^3 \quad \text{,, ,} \Delta^8 + B_{8,4} \delta \Gamma \quad \text{,, ,} \Delta^8 \\ B_{10,2} \delta^4 \Gamma^4 \quad \text{,, ,} \Delta^{10} + B_{10,4} \delta^2 \Gamma^2 \quad \text{,, ,} \Delta^{10} + B_{10,6} \dots g^3 \Lambda^6 v^4 \Delta^{10} \\ \dots \end{array} \right] \tag{44}$$

The Force between Atoms.

The preceding calculations apply to the case of two moving electrical charges. It is now required to sum the forces over each individual part of two atoms. The atoms are supposed to be constituted as before described of a sphere of positive electricity of uniform density within which the electrons lie all in one plane, but in different concentric rings in that plane, each describing a circular orbit with the same angular velocity. In the case where the distance between the atoms is small, so that they come to stable equilibrium positions relative to each other, it will be considered that their axes of revolution are parallel to each other.

The positive sphere may be considered as a stationary charge, and the equations (42) and (44) give the force between a moving and a stationary charge if the radius a or a' of one of the orbits is made equal to zero. There is then no phase angle γ , and the correct value of the force is obtained if all terms containing γ are omitted, and the proper sign of the charge used.

The process of writing down the terms that are given by equations (42) and (44) for the forces along \mathbf{r} , and perpendicular to \mathbf{r} for each individual electron and the positive spheres in the atoms, and then expanding them in powers of the distance, v , by the binomial theorem, is rather long, but it is straightforward. Inasmuch as general equations have been obtained, which apply to any atom including all terms in the expansion up to v^{-6} inclusive, but not including v^{-8} , an example of the process is omitted, and the particular solutions obtained from the general equation.

If m denotes the radius of the orbit of one electron, e , in the atom A, referred to the radius of some selected orbit, a^* , as a unit, so that the radius in centimetres is $a = ma^*$, and if m' denotes the radius of the orbit of e' in the atom A' in a similar manner, then it has been shown that the force which the whole atom A' exerts upon the atom A resolved along \mathbf{r} is

$$\bar{F}_{\text{along } \mathbf{r}} = \frac{3}{16} \frac{k_2 k_2' e^2}{v^6 a^{*2}} \left\{ (8 - 12 \cos^2 \lambda) \beta^2 v^2 - 40 + 200 \cos^2 \lambda - h \cos^4 \lambda \right\}, \quad (45)$$

and the force resolved in the meridian plane perpendicular to \mathbf{r} is

$$\bar{F}_{\text{perp. } \mathbf{r}} = \frac{3}{16} \frac{k_2 k_2' e^2}{v^6 a^{*2}} \left\{ 4\beta^2 v^2 - 40 + 70 \cos^2 \lambda \right\} \sin 2\lambda, \quad (46)$$

where
$$h = 17.5 + 630 \left(\frac{k_4}{k_2} + \frac{k_4'}{k_2'} \right), \dots \quad (47)$$

and
$$k_2 = \Sigma m^2; k_4 = \Sigma m^4; k_2' = \Sigma m'^2 \text{ and } k_4' = \Sigma m'^4. \quad (48)$$

All terms in v^{-6} containing β have been omitted as being small in comparison with the other terms. The summation indicated in (48) must be taken over every electron in the atom designated. Table III. (p. 45) will be found convenient as giving the values of k for some atoms for which the data are available.*

Equilibrium Positions.

The chart, fig. 8, represents the graphs of equations (45) and (46) for several different combinations of two atoms each, when the force is equated to zero. The curves are given in terms of βv and the angle of latitude λ as polar coordinates. Equating (45) to zero, we have

$$\beta^2 v^2 = \frac{40 - 200 \cos^2 \lambda + h \cos^4 \lambda}{8 - 12 \cos^2 \lambda}, \dots \quad (49)$$

and from (46)

$$\beta^2 v^2 = 10 - 17.5 \cos^2 \lambda; \dots \quad (50)$$

whence the angle λ at which equilibrium is obtained is given by the equation

$$\cos^2 \lambda = -\frac{3}{\frac{h}{10} - 21} \pm \sqrt{\left(\frac{3}{\frac{h}{10} - 21} \right)^2 + \frac{4}{\frac{h}{10} - 21}}. \dots \quad (51)$$

The curves as given are independent of any assumption as to the value of β ; but the values of the distance, v , and of the force are dependent upon β . The forces along and perpendicular to r for a particular case, each atom being of the same kind, a single ring of three electrons, are charted in figs. 9 and 10. The value of the speed of the electrons chosen is $1/316$ the velocity of light, so that $\beta = 1/316$ and $\beta^2 = 10^{-5}$. These charts are typical of all atoms, and the equations have been worked out for constant values of the forces, varying by fixed intervals, so that the rate of change of the forces and their directions are both shown. The arrows indicating the directions of the forces show that, for a small displacement of the atom A' from the position of equilibrium, the force returns the atom to that position for

* These equations apply equally well to an atom of the polar-system kind in which the electrons circulate around a central positive charge, but the radii of the orbits in Table III. do not apply to this kind of atom.

any displacement in the plane of the paper. Perpendicular to the paper it has been shown that the force is zero, and hence the atom is free to move completely around the small circle of latitude passing through the points of intersection of the two dotted curves of zero force.

It is considered that two atoms coming into such stable positions relative to each other as at A and A', constitute a diatomic molecule. The chart clearly shows that the angles at the equilibrium positions differ according to the particular combination of atoms, and likewise the degree of stability must also vary. It is possible to measure exactly the degree of stability, and to say which combinations are the most likely to persist, and to withstand the shocks that they must receive in order to exist as elements.

Some consideration has been given to the equilibrium positions assumed by more than two molecules, and the figures shown in fig. 13 have been calculated. It would be beyond the scope of this paper to give these calculations in detail.

Internal Moments.

There is another condition for perfect equilibrium between two atoms to be considered. The sum of the moments of the forces which the revolving electrons in one atom exert upon the other atom should be zero. To examine this question we will find the forces which one electron exerts upon another, all forces being resolved along the tangent line to the orbit of the first atom defined by the unit vector

$$\tau = \frac{k \times r_1}{a} = Sj - Ci. \quad . \quad . \quad . \quad (52)$$

It may be shown from equations (1) to (4) that the instantaneous values of the four component forces resolved along this unit tangent are

$$F_1 = \frac{ee'}{KR^3} (Cx + a' \sin \gamma) (Sj - Ci), \quad . \quad . \quad . \quad (53)$$

$$F_2 = -\frac{ee'\beta\beta' \cos \gamma}{KR^3} (Cx + a' \sin \gamma) (Sj - Ci), \quad . \quad . \quad (54)$$

$$F_3 = -\frac{\mu ee' a' \omega^2 \sin \gamma}{R} \\ = -\frac{\mu ee' a' \omega^2 \sin \gamma}{s} \left[1 - \frac{1}{2}u + \frac{1}{2} \cdot \frac{3}{4}u^2 - \frac{1}{2} \cdot \frac{3}{4} \cdot \frac{5}{6} \cdot u^3 + \dots \right], \quad (55)$$

$$F_4 = -\frac{\mu ee' a' x \omega^2 \cos \gamma}{s^3} (-aC + a'C')(1+u)^{-\frac{3}{2}}. \quad . \quad . \quad (56)$$

By these equations it becomes evident that the instantaneous moment of the force exerted by one electron upon another cannot at all times vanish for any phase-angle γ . The motion of each electron cannot, therefore, remain perfectly uniform in its orbit, but must be subject to periodic displacements every revolution. These displacements must be small because of the interaction of the adjacent electrons in the same ring. If they tend to approach each other, an opposing force is produced by the electrostatic forces between them.

The average values of the forces on one electron obtained from (53) to (56) are

$$\begin{aligned} \bar{F}_1 = \frac{ee'a' \sin \gamma}{s^3} \left\{ 1 - \frac{3x^2}{2s^2} + \frac{15x^2}{4s^4} (a^2 + a'^2) + \left[\frac{3aa'}{s^2} - \frac{15aa'x^2}{s^4} \right] \cos \gamma \right. \\ \left. + \frac{15a^2a'^2}{2s^4} \cos^2 \gamma + \frac{3}{2} \cdot \frac{5}{4} \cdot \frac{7}{8} \cdot \frac{2^3}{s^6} \left[\frac{3}{8} x^4 (a^2 + a'^2) \right. \right. \\ \left. \left. + \left(\frac{3}{2} x^2 aa' (a^2 + a'^2) - \frac{3}{4} x^4 aa' \right) \cos \gamma - \frac{9}{2} x^2 a^2 a'^2 \cos^2 \gamma + \dots \right] \right\}, \quad (57) \end{aligned}$$

$$\bar{F}_2 = \bar{F}_1 \beta \beta' \cos \gamma, \quad \dots \dots \dots \quad (58)$$

$$\begin{aligned} \bar{F}_3 = -\frac{\mu ee'a' \omega^2 \sin \gamma}{s} \left\{ 1 + \frac{1}{2} \cdot \frac{2}{s^2} aa' \cos \gamma + \frac{1}{2} \cdot \frac{3}{4} \cdot \frac{2^2}{s^4} \left[\frac{x^2}{2} (a^2 + a'^2) \right. \right. \\ \left. \left. - aa'x^2 \cos \gamma + a^2 a'^2 \cos^2 \gamma \right] + \frac{1}{2} \cdot \frac{3}{4} \cdot \frac{5}{6} \cdot \frac{2^3}{s^6} \left[\frac{3x^2}{2} (a^2 + a'^2) aa' \cos \gamma \right. \right. \\ \left. \left. - 3x^2 a^2 a'^2 \cos^2 \gamma + a^3 a'^3 \cos^3 \gamma \right] + \frac{1}{2} \cdot \frac{3}{4} \cdot \frac{5}{6} \cdot \frac{7}{8} \cdot \frac{2^4}{s^8} \left[\frac{3x^4}{8} (a^2 + a'^2) \right. \right. \\ \left. \left. - 2aa' \cos \gamma \right]^2 + 3x^2 (a^2 + a'^2) a^2 a'^2 \cos^2 \gamma \right. \\ \left. \left. - 6x^2 a^3 a'^3 \cos^3 \gamma + a^4 a'^4 \cos^4 \gamma \right] + \dots \right\}, \quad (59) \end{aligned}$$

$$\bar{F}_4 = 0. \quad \dots \dots \dots \quad (60)$$

If these average values are summed for every electron in the two atoms, the process in general becomes involved. In the case of two atoms with a single ring of three electrons each, it has been shown that there is equilibrium of the average moments of the forces when the electrons are exactly in phase, making $\gamma=0$, $\gamma=\frac{1}{3}2\pi$, $\gamma=\frac{2}{3}2\pi$. It is assumed that the atoms are in translational equilibrium, the angle of latitude being $65^\circ 50'$, and distance $\beta^2 r^2 = 7.075$, in which position the sum of the moments of the forces is zero. For a small displacement on either side of this position the sum of the moments tends to return the atoms to this fixed position, making $\gamma=0$, etc., and showing stability. When the two

atoms are once in this fixed position, the forces keep them synchronized. If the translational position is other than that of equilibrium, the angles for the relative phases for moment equilibrium differ. For example, if the two atoms were situated in positions latitude 90° and distance $\beta^2 v^2 = 5$, the phase positions for stable equilibrium as to moments would be $\gamma = \frac{1}{6} 2\pi$, $\gamma = \pi$, and $\gamma = \frac{5}{6} 2\pi$.

Formation of Ions.

It may be shown that a perfectly neutral atom—that is, an atom the sum of whose positive and negative charges is zero—will attract or repel a charge, say an electron, or a positive sphere not containing an electron, according to the relative positions of the atom and the charge, with a force inversely as the fourth power of the distance when the distance is not too small. The force becomes inappreciable beyond molecular range. The expressions for the forces are derived in a similar manner to those which apply to atoms in (45) and (46),

$$F_{\text{along}} = \frac{ee' 3k_2}{a_*^2 64} \left\{ 32(1 - 1.5 \cos^2 \lambda)v^{-4} + \frac{k_4}{k_2} (-40 + 200 \cos^2 \lambda - 175 \cos^4 \lambda)v^{-6} + \dots \right\}, \quad (61)$$

$$F_{\text{perp.}} = \frac{ee' \sin 2\lambda 3k_2}{a_*^2 64} \left\{ 16v^{-4} + \frac{k_4}{k_2} (-40 + 70 \cos^2 \lambda)v^{-6} + \dots \right\}. \quad (62)$$

In these equations e is to be taken as negative, the charge of one electron, and e' positive or negative. If F_{along} is positive it denotes an attraction, and if $F_{\text{perp.}}$ is positive the force is towards the axis and from the equator. If the charge is positive and situated on the equator, where $\cos \lambda = 1$, the atom attracts the charge toward itself. The perpendicular component forces it toward the equator. If the positive charge is on the axis of the atom the charge is repelled from the atom. At the critical angle $36^\circ 18'$ the force changes from attraction to repulsion for large distances.

The Force at Large Distances.

When the distance between two atoms is very large compared with molecular range, as in gravitational problems, the equations for the force become much simplified. Consider the action of one revolving electron upon another situated in the most general position, their axes making any angle with each other. Equations (18) and (23) give the instantaneous

values of the first and second components of the force respectively. The third and fourth components cancel each other producing a resultant of zero. If we do not care to consider terms higher than the inverse second power of r equation (18) reduces to

$$F_1 = - \frac{ee'}{Kr^3} \mathbf{r} \dots \dots \dots (63)$$

which is simply the electrostatic repulsion between the electrons. In an atom this is exactly balanced or neutralized by the attraction between the positive spheres and the electrons, together with the repulsion between the positive spheres themselves, thus making the force zero as far as the first component is concerned.

It is evident that the only terms that can contribute anything with terms in $1/r^2$ in (23), the second component, are

$$F_2 = \frac{\mu ee' aa' \omega \omega'}{r^3} [CC' \cos \alpha + SS'] \mathbf{r} \dots \dots (64)$$

If this is averaged over a long time on the assumption that the angular velocities of the two electrons are incommensurable, the result is zero for the r^{-2} terms. The first terms that do not vanish with this hypothesis are those in r^{-4} . But if the assumption is made that the angular velocities are equal, and the electrons in synchronism, we obtain certain terms in r^{-2} as follows—

$$\bar{F}_2 = \frac{\mu ee' aa' \omega^2}{2r^3} \mathbf{r} (1 + \cos \alpha) \cos \gamma \dots \dots (65)$$

This result is directly obtained from the expression for the average force (25), for when r is large the terms containing A, B, C, D, and E are negligible compared with the remaining terms, and we have (65) directly from this equation. The total attraction between the two atoms of which these two electrons are constituents is, therefore, found by taking the sum of the forces given by (65) for each pair of electrons in the two atoms, one electron from each.

To find the Radius of the Outside Ring of Electrons in an Atom.

Consider a single ring of n_1 electrons distributed at equal intervals around the circumference within the sphere of positive electrification of the atom, revolving with a constant angular velocity. An equation of equilibrium may be derived from the fundamental equations (1), (2), (3), and (4) by

resolving all the forces upon one electron in the ring along the direction of the radius, and equating this to the centrifugal force developed by the revolving electron. If the electron, the forces upon which are to be calculated, is situated at A, and the next adjacent electron at B, the angle AOB = $2\pi/n$. The four forces upon A due to B become from equations (1) to (4)

$$F_1 = \frac{e^2}{KR^2}, \quad \text{a repulsion along the line BA.}$$

$$F_2 = \frac{\mu e^2 q^2}{R^2} \cos \frac{2\pi}{n}, \quad \text{an attraction along AB.}$$

$$F_3 = \frac{\mu e^2 q^2}{Ra_1}, \quad \text{a force directed from A parallel to the line BO, and in the direction OB.}$$

$$F_4 = 0.$$

Since the angle AOB equals $2\pi/n$, AOB = π/n , and $R = 2a_1 \sin \pi/n$, we have

$$F_1 = \frac{e^2}{4Ka_1^2 \sin^2 \frac{\pi}{n}}, \quad \text{a repulsion along BA.}$$

$$F_2 = \frac{\mu e^2 q^2}{4a_1^2 \sin^2 \frac{\pi}{n}} \cos \frac{2\pi}{n}, \quad \text{an attraction along AB.}$$

$$F_3 = \frac{\mu e^2 q^2}{2a_1^2 \sin \frac{\pi}{n}}.$$

The force F_3 , being parallel to OB would be tangential to the circle when the electron is situated at a point ninety degrees from A. When B is nearer to A than a right angle the component along OA is a repulsion, but when farther it is an attraction toward the centre. Resolving these three component parts of the force upon the electron A due to B along the radius OA, we have

$$F_1 \cos (\pi - \text{BAO}) = -F_1 \sin \frac{\pi}{n} = -\frac{e^2}{4Ka_1^2} \operatorname{cosec} \frac{\pi}{n},$$

$$F_2 \cos \text{BAO} = F_2 \sin \frac{\pi}{n} = \frac{\mu e^2 q^2}{4a_1^2} \left(\operatorname{cosec} \frac{\pi}{n} - 2 \sin \frac{\pi}{n} \right),$$

$$F_3 \cos \text{OAF}_3 = -F_3 \cos \frac{2\pi}{n} = \frac{\mu e^2 q^2}{2a_1^2} \left(2 \sin \frac{\pi}{n} - \operatorname{cosec} \frac{\pi}{n} \right).$$

The other $(n-1)$ electrons in the ring give similar expressions. If F' , F'' , and F''' denote the resultants of all the forces in the ring due to F_1 , F_2 , and F_3 respectively, we find

$$F' = -\frac{e^2}{4Ka_1^2} S, \quad \text{a repulsion from O, . . . (66)}$$

$$F'' = -\frac{\mu e^2 q^2}{4a_1^2} (2P - S), \quad (67)$$

$$F''' = \frac{2ue^2 q^2}{4a_1^2} (2P - S), \quad (68)$$

where

$$S = \operatorname{cosec} \frac{\pi}{n} + \operatorname{cosec} \frac{2\pi}{n} + \operatorname{cosec} \frac{3\pi}{n} + \dots + \operatorname{cosec} (n-1) \frac{\pi}{n} \quad (69)$$

$$P = \sin \frac{\pi}{n} + \sin \frac{2\pi}{n} + \sin \frac{3\pi}{n} + \dots + \sin (n-1) \frac{\pi}{n}. \quad (70)$$

More than One Ring of Electrons.

The effect upon the outside ring of electrons of an inside ring is approximately the same as if all the electrons in the inside ring were situated at the centre of the sphere. If the total number in all electrons in inside rings is u , supposed to be at the centre of the sphere, the force of repulsion which they exert upon the single electron at A in the outside ring is

$$F_5 = -\frac{ue^2}{Ka_1^2}.$$

This must be added to the sum of the three forces (66), (67), and (68) to obtain the whole force upon A due to all the rings of electrons.

Sphere of Positive Electrification.

If it is assumed that the electrons are within a sphere of positive electrification of radius b , its attraction upon the electron at A, assuming uniform density, is

$$F_6 = \frac{ee'a_1}{Kb^3} = \frac{pe^2a_1}{Kb^3},$$

where p is the total number of electrons in the atom.

If F denotes the sum of the forces due to the ring of electrons, the central electrons, and the positive sphere upon the one electron at A in the outside ring, we have

$$F = F' + F'' + F''' + F_4 + F_5 + F_6,$$

or

$$F = -\frac{e^2}{4Ka_1^2}S + \frac{\mu e^2 q^2}{4a_1^2}(2P - S) - \frac{ue^2}{Ka_1^2} + \frac{pe^2 a_1}{Kb^3}.$$

Since A is moving in a circular orbit, its acceleration is q^2/a_1 , and if m denotes its mass, we have

$$F = mq^2/a_1 = ma_1\omega^2.$$

Equating these forces and substituting for μ its equivalent $1/Kc^2$, c being the velocity of light, and multiplying each term by Ka_1^2/e^2 , we have

$$-\frac{S}{4} + \frac{a_1^2\omega^2}{4c^2}(2P - S) - u + \frac{pa_1^3}{b^3} = \frac{mK\omega^2 a_1^3}{e^2}. \quad (71)$$

Another assumption, which is introduced from the ring theory, is that the volume of the positive sphere is proportional to the total number of electrons contained therein. If b and b' are the radii of two different kinds of atoms containing p and p' electrons respectively, we have on this assumption $(b/b')^3 = p/p'$. In the atoms containing two electrons, the radius is b' , and $p' = 2$, hence

$$b^3 = \frac{p}{2} b'^3. \quad (72)$$

Substituting this value of b in (71), we find

$$\left(\frac{1}{b'^3} - \frac{mK\omega^2}{2e^2}\right)a_1^3 + \frac{2P - S}{8} \frac{\omega^2 a_1^2}{c^2} = \frac{S}{8} + \frac{u}{2}. \quad (73)$$

When $\frac{a\omega}{c} = \beta$ is small, the radius referred to the positive sphere is given by

$$a_1^3 = \frac{S}{8} + \frac{u}{2} \quad (74)$$

or, restoring b from (72),

$$\left(\frac{a}{b}\right)^3 = \frac{1}{p} \left(\frac{S}{4} + u\right). \quad (75)$$

Limiting Value of the Angular Velocity of the Electrons to remain within the Positive Sphere.

It is evident that the term containing a_1^2 in (73) may be omitted as being small compared with unity, since $\frac{a_1\omega}{c} = \beta$ is probably small compared with unity. Hence, if

$$x = \frac{1}{b^3} - \frac{mK\omega^2}{2e^2}, \quad (76)$$

we have

$$a_1^3 = \frac{1}{x} \left(\frac{S}{8} + \frac{u}{2} \right) (77)$$

To find the limiting value of the angular velocity so that the electrons will just remain within the sphere, put $a = b$, and $a_1^3 = \frac{P}{2} b^3$, whence, when $S=1$, $P=1$, $u=0$, and $p=2$, for the two-electron atom, $\omega^2 = \frac{7e^2}{4ma_1^3}$. Taking the mass of the electron as $.878 \times 10^{-27}$ gram, and $e = 4.77 \times 10^{-10}$ electrostatic unit, we find $\omega = \frac{21300}{a_1}$. As has been explained in another place, it seems probable that the orbits of the electrons within the atoms, and the atoms themselves, are many times smaller than the dimensions of the molecules, though the exact amount is uncertain. Using the smaller value of "a" calculated above (p. 56) as $.72 \times 10^{-12}$ cm., we find $n = .556 \times 10^{22}$. This is nearly 1000 times greater than X-ray frequencies, and is an indication that the linear velocity of the electron might approach close to the velocity of light, at which speed the law of the forces rapidly changes, before the electron would leave the positive sphere due to its own centrifugal force.

The Correction Term.

In finding the expression for the radius of the outside ring (73) or (77), the assumption was made that the u electrons which are not in the outside ring are all concentrated at the centre of the sphere. It can be shown that if the same number of electrons is distributed in a second ring within the outside ring, instead of being at the centre of the sphere, the outside ring would have a greater radius. To maintain the outside ring the same more central electrons are required than if they were distributed in inside rings. That is, the true value of a_1 may be found by the formulæ (74) or (75) by adding to u , the total number of electrons in the inside, a

correction term when they are supposed to be transferred to the centre. The correction term denoted by c , to be added to u , may be found from measurements upon the photographs of the experimental atoms, and the method is as follows.

Let O be the centre of the atom, A an electron in the outside ring, and B one in an inside ring. The repulsion of B upon A is e^2/KR^2 , and this force resolved along the radius OA is $\frac{e^2\overline{AC}}{KR^3}$, where \overline{AC} is the geometrical projection of the distance R between the electrons upon the diameter through A. The force of repulsion of all the u electrons within the outside ring upon the one electron A in the outside ring is $\frac{e^2}{K}\sum\frac{\overline{AC}}{R^3}$, the summation being extended to all of the outside electrons. If it is supposed that all these inside electrons are transferred to the centre of the sphere the force of repulsion upon A would be $\frac{ue^2}{Ka_1^2}$. In order that the outside ring shall not be disturbed these forces should equal each other, but it is found by the measurements on the negatives that the former is always larger than the latter. Let h be the measured difference, then

$$\frac{e^2}{K}\left(\sum\frac{\overline{AC}}{R^3} - \frac{u}{a_1^2}\right) = h.$$

This difference may be considered as the force due to c additional electrons at the centre of the sphere, and c is the correction term required. Since the force upon A due to one electron at the centre is $\frac{e^2}{Ka_1^2}$, we have

$$c = \frac{hKa_1^2}{e^2} = a_1^2\sum\frac{\overline{AC}}{R^3} - u, \dots (78)$$

by which it is evident that c is a term which should be added to u in equation (74), and it may be found from the negatives by measuring both $\sum\frac{\overline{AC}}{R^3}$ and a_1 , the average radius of the outside ring.

Since the outside ring is not a true circle in the experimental atoms, it is found that the value of c cannot be obtained with sufficient accuracy by selecting a single electron in the outside ring and calculating the forces upon it.

Consequently the process has been repeated for each electron in the outside ring, and the mean values of $\Sigma \frac{AC}{R^3}$ and of "a" determined to obtain "c." An illustration is given in fig. 14 (Pl. I.) of the method employed for each atom. The measurements were made upon a drawing-board, the figure having been projected upon the paper from the negative by a stereopticon, and points marked at the centre of each sphere. Table VII. gives the measured values on the combination $11=7+4$, consisting of an outside ring of seven and an inside ring of four. The average value of

TABLE VII.

$$p = n_1 + n_2 = 7 + 4.$$

1.				2.			3.		
No.	R.	AC.	AC/R ³ .	R.	AC.	AC/R ³ .	R.	AC.	AC/R ³ .
8 ...	2.72	2.64	0.1303	2.67	2.64	0.1386	3.80	3.58	0.0654
9 ...	4.80	4.62	0.0418	3.77	3.48	0.0650	2.79	2.72	0.1253
10 ...	5.10	5.05	0.0318	5.30	5.28	0.0355	4.85	4.68	0.0417
11 ...	3.36	3.18	0.0840	4.76	4.54	0.0421	5.58	5.55	0.0320
			0.2942			0.2812			0.2644
4.				5.			6.		
8 ...	4.80	4.64	0.0420	5.28	5.28	0.0358	4.82	4.72	0.0421
9 ...	2.73	2.62	0.1288	3.96	3.66	0.0608	4.96	4.82	0.0395
10 ...	3.47	3.25	0.0777	2.53	2.53	0.1562	2.94	2.76	0.1085
11 ...	5.26	5.20	0.0358	4.28	4.00	0.0511	2.76	2.58	0.1227
			0.2843			0.3039			0.3128
7.									
8 ...	3.92	3.68	0.0610						
9 ...	5.44	5.44	0.0338						
10 ...	4.40	4.17	0.0490						
11 ...	2.49	2.45	0.1588						
			0.3026						

No.	a_1 .	a_2 .	$\Sigma AC/R^3$.
1 ...	3.84		0.2942
2 ...	3.96		0.2812
3 ...	4.12		0.2644
4 ...	3.94		0.2843
5 ...	3.90		0.3039
6 ...	3.74		0.3128
7 ...	3.93		0.3026
8 ...		1.40	
9 ...		1.54	
10 ...		1.40	
11 ...		1.52	
Av. ...	3.92	1.465	0.2919

$$\frac{4}{a_1^2} = 0.2603.$$

$$\Sigma AC/R^3 - \frac{4}{a_1^2} = 0.0316.$$

$$c = 0.4856.$$

$\Sigma \frac{AC}{R^3}$ for the seven spheres in the outside ring is $\cdot 2919$, and of a_1 $3\cdot 92$. As $u=4$ we find by (78) $c=0\cdot 4856$. The radius of the outside ring referred to the radius of the positive sphere in hydrogen (two electrons) is, therefore, $1\cdot 505$, obtained from the formula

$$a_1^3 = \frac{1}{2} \left(\frac{S}{4} + u + c \right) \dots \dots \dots (79)$$

Table VIII. gives the value of $S/4$ for the outside rings from 2 to 12. Without the correction term the radius a_1 is $1\cdot 468$, $2\cdot 5$ per cent. less than it is with it.

TABLE VIII.

<i>n.</i>	$\frac{S}{4}$
2	0·2500
3	0·5762
4	0·9571
5	1·3764
6	1·8273
7	2·3285
8	2·8049
9	3·3248
10	3·8625
11	4·4160
12	4·9840

The Combination 6-0.

This combination obtained experimentally as in figure 5 (Pl. II.) is interesting because it has been shown that a ring of six with none at the centre cannot be stable*. The experimental figure shows that there are really two rings of three each having different radii in the ratio of about 9 to 8. The measurements are given in Table IX. (p. 84). Equating the force upon one electron due to the other five to that due to the positive sphere, we find

$$b^3 = \frac{pa}{\Sigma \frac{AC}{R^3}}$$

* J. J. Thomson, Phil. Mag., March 1904.

TABLE IX.—Negative 7c.

$$p=6-0.$$

No.	1.			2.			3.		
	R.	AC.	AC/R ³ .	R.	AC.	AC/R ³ .	R.	AC.	AC/R ³ .
1 ...	—	—	—	6·04	2·30	·01045	11·11	9·76	·00711
2 ...	6·04	3·74	·01697	—	—	—	6·14	3·76	·01630
3 ...	11·11	9·88	·00721	6·14	2·66	·01150	—	—	—
4 ...	12·11	12·11	·00683	9·83	8·59	·00905	5·99	3·32	·01543
5 ...	10·79	9·32	·00742	11·55	11·55	·00750	10·55	9·02	·00768
6 ...	5·88	3·54	·01745	9·41	8·15	·00978	11·65	11·65	·00737
		Total	·05588	·04828	·05389

4.				5.			6.		
1 ...	12·11	12·11	·00683	10·79	9·18	·00731	5·88	2·14	·01055
2 ...	9·83	8·71	·00920	11·55	11·55	·00750	9·41	8·14	·00976
3 ...	5·99	2·64	·01230	10·55	8·99	·00766	11·65	11·65	·00737
4 ...	—	—	—	5·72	3·07	·01640	9·62	8·17	·00920
5 ...	5·72	2·47	·01320	—	—	—	5·83	2·46	·01245
6 ...	9·62	8·27	·00930	5·83	3·37	·01700	—	—	—
		Total	·05083	·05587	·04933

	<i>a</i> '.	AC/R ³ .
1 ...	6·42	·05588
2 ...	5·46	·04933
3 ...	6·21	·05083
4 ...	5·72	·04828
5 ...	6·10	·05389
6 ...	5·48	·05587
Av.	5·898	·052347

$$b^3 = \frac{pa}{\sum \frac{AC}{R^3}} = 677. \quad b = 8·718.$$

$$\frac{a}{b} = ·6725.$$

The measured value of $\sum \frac{AC}{R^3}$ is ·0523, and the average value of *a* is 5·898, and as *p*=6, *b*=8·781, and the ratio *a*/*b*=·6725 from the experimental negative. This is the same value that is obtained from formula (74), if the ratio is found for a ring of six electrons.

III. *The Viscosity of Glacier Ice.*

By R. M. DEELEY, *M.Inst.C.E., F.G.S.*, and P. H. PARR*.

[Plate III.]

SEVERAL authors have already dealt with the flow of glaciers considered as viscous fluid masses; but the absence of reliable data concerning their thickness and the slopes of their surfaces has rendered impossible any exact mathematical analysis of their movement. However, during recent years a good deal of detailed information has been published concerning the dimensions of several glaciers, and the velocities with which they move. One of the most thorough pieces of work of this description has been carried out by Blümcke and Hess on the Hintereis Glacier, Otztal, in the Austrian Alps.

Before discussing the latest data upon which a calculation of the viscosity of glacier ice can be based, we will give in outline the work on this subject which has been done up to date.

In 1888 Dr. Main † published the results of some experiments made in the winter of 1886-7 on the yielding to tension, at several degrees below the freezing-point, of bars of ice formed by freezing water in an iron mould. Tyndall had previously contended that glacier ice would not yield to tension and was not, therefore, to be considered as a viscous substance. Main's experimental results, however, disposed of this objection.

In a paper published in 1888, Kelvin ‡ calculated from the data furnished by Main's experiments the viscosity of the ice used by Main, and thereby arrived at some definite conclusions concerning the probable thickness of ice sheets and glaciers under certain conditions. He, however, did not publish the figure obtained by him for the viscosity.

In 1888 McConnell and Kidd § published the results of some experiments on the yielding of various kinds of ice to tension and compression. These experiments were made partly with the apparatus used by Dr. Main.

In 1888 A. Odin || endeavoured to construct equations

* Communicated by the Authors.

† Proc. Roy. Soc. vol. xlii. (1907).

‡ 'Popular Lectures and Addresses,' vol. ii. pp. 319-359.

§ Proc. Roy. Soc. vol. xlv. pp. 331-367.

|| A. Odin, "Essai d'un application des principes de la mécanique à l'écoulement des glaciers." *Bull. Soc. vand. d. sc. nat.* (3) vol. xxiv. p. 33 (1888.)

illustrating the nature of glacier flow ; but his assumptions were not satisfactory, and his results were too complex to be of any practical value. The conclusions he reached can be easily obtained by much more simple methods.

In 1891 McConnell * made further experiments on the shear properties of ice. He found that an ice crystal was easily sheared without fracture along planes at right angles to the optic axis ; but not in any other direction. This explained some of the results McConnell and Kidd had previously obtained, among which may be mentioned the rigidity under stress of the tensile test-bar the optic axis of which was at right angles to the axis of the bar, and also the very small yield under stress of a bar consisting of a number of prisms of ice with their optic axes parallel with the axis of the test-bar. It also explained why the test-bar having the optic axis at an angle of 45° with the axis of the test-bar yielded rapidly and continuously.

In 1895 R. M. Deeley † showed that the details of glacier flow, so far as was then known, resembled in every particular the flow of liquids through capillary tubes. In such tubes, when the velocity is not too great, the flow is steady, *i. e.* free from eddies. Poiseuille was the first to make extensive experiments on the flow of liquids through capillary tubes, and from them he obtained an empirical formula, which has since been found to be identical with that obtained by mathematical analysis. Deeley showed that his equations could be applied to the movements of glaciers. They are as follow :—

$$\text{Maximum velocity} = \frac{Pb^2}{2\eta} \dots \dots (1)$$

where P is the bodily force producing motion, being the component of gravity in the direction of movement, *b* the thickness of the ice, and η its viscosity.

Also the volume passing any cross-section in unit of time

$$= \frac{Pb^3a}{3\eta}, \dots \dots (2)$$

when *a* is the width of the section.

For a semicircular section the flux

$$= \frac{\pi}{16} \cdot \frac{Pb^4}{\eta} \dots \dots (3)$$

* Proc. Roy. Soc. vol. xlix. pp. 323-343.

† Geol. Mag. Sept. 1895, pp. 408-415.

In 1897 L. de Marchi* investigated the internal movements of glaciers, and made some calculations which appeared to show an agreement between theory and fact; but the agreement he obtained was illusive, for he had, according to Weinberg, misplaced a decimal point and omitted to include the value of gravity in his equations.

It would be a distinct advantage to have a name for the unit of viscosity expressed in C. G. S. units, and we would suggest that the word Poise be used for this; for it is to Poiseuille that we owe the experimental demonstration that when a liquid flows through a capillary tube of considerable length, at constant temperature, the viscosity is constant at all rates of shear, provided that the flow is not turbulent. In the case of a soft solid (plastic substance) the so-called viscosity is not the same for all rates of shear: whereas the viscosity of a liquid is a physical constant † and should be named.

We have seen that glacier ice consists of crystal granules which not only shear freely along planes at right angles to the optic axis; but also undergo changes at their bounding surfaces which enable the mass to suffer continuous distortion under stress. The ability of glacier ice to spread out into piedments whose upper surfaces are very nearly level also shows that such shear may take place under very small stresses. Both Main and McConnell & Kidd found that test-bars of glacier ice did not yield in a regular manner, nor was the rate of yield always quite proportional to the stress. Other experimentalists have also noticed this. This is considered to arise mainly from the fact that the glacier grains are large as compared with the size of the test-bar, and that the yielding is due to interfacial movement as well as shear in the granules.

As compared with the mass of a glacier, however, the granules are small, and they may even more nearly be compared with the molecules of a small volume of such a liquid as oil. But even though the viscosity of a glacier cannot probably be considered as quite the same thing as the viscosity of water and other mobile liquids, glacier ice may yet, for all practical purposes, be regarded as a perfect liquid of high viscosity. It will flow until all the stresses are in hydrostatic equilibrium.

In 1905 Boris Weinberg ‡ made some torsion experiments on the stream ice of the Neva. In the case of stream ice his

* "L'attrito interno nel movimento du ghiacciai." *Rendic. Ist. Lombardo* (2) vol. xxx. p. 284 (1897).

† Osborne Reynolds, *Phil. Trans.* 1856, p. 166.

‡ *Annalen der Physik* (Leipzig), Bd. xviii, Heft 1, pp. 81-91 (1905).

bars were cut with their lengths parallel to the optic axis ; the torsion shear planes were, therefore, at right angles to the optic axes. Torsional shear of this nature would distort the planes of the three secondary axes of the crystals, and on this account the experiment cannot be compared with the 1891 experiments of McConnell on the shear at right angles to the optic axes of single ice crystals. Weinberg's results were not, in these cases, obtained with wide variations of stress, and we are therefore without information as to the variation of the rate of shear with varying stress and amount of distortion. His value for the viscosity of torsional shear for one bar he tested was

$$\eta = 1.244 \times 10^{13} \text{ poises.}$$

Other bars, no doubt of different crystalline structure, gave higher viscosities.

In 1907 * Weinberg made a number of torsional experiments with bars of glacier ice and gives the viscosity as

$$\eta = 0.8 \times 10^{13} \text{ poises.}$$

He also calculated † the viscosity of the ice of the Hintereis Glacier (using the data furnished by Blümcke and Hess) by the formula given by Deeley in 1895, which, however, he does not appear to have seen. He obtained

$$\eta = (1.74 \pm 1.10) \times 10^{13} \text{ poises.}$$

In 1908 R. M. Deeley ‡ made some calculations of the viscosity of glacier ice. He estimated in ten instances the thickness of the Mer de Glace, the Morteratsch, the Lower Grindelwald, and the Great Aletsch Glaciers. Although the variations in the calculated viscosities were large, the mean result, which may be somewhat in error, was

$$\eta = 7.89 \times 10^{13} \text{ poises.}$$

He also estimated § from McConnell's experiments the viscosity of crystalline ice at 0° C., in a direction at right angles to the optic axis, and found it to be about

$$\eta = 1 \times 10^{10} \text{ poises.}$$

McConnell's experiment was made with a single crystal, and this, coupled with the fact that the shear did not disturb the crystal axes, probably accounts for the viscosity being much smaller than that obtained by Weinberg in his torsion experiments in 1905.

* *Annalen der Physik*, Bd. xxii. Heft 2, pp. 331-332 (1907).

† *Zeitschrift für Gletscherkunde*, 1 Band (1906-7), 5 Heft.

‡ *Proc. Roy. Soc. A.* vol. lxxx. pp. 250-259 (1908).

§ *Ibid.*

In 1910 Weinberg *, following a criticism of his figures by Hess, gave a corrected value

$$\eta = (1.75 \pm 0.70) \times 10^{13} \text{ poises.}$$

In 1912 R. M. Deeley † considered the results obtained by Dr. Main in his tension experiments, and obtained

$$\eta = 6 \times 10^{12} \text{ poises}$$

for the viscosity at 0° C. of fine crystalline ice frozen in an iron mould. The individual experiments showed very considerable differences; the figures taken are the mean at 0° C., being obtained by plotting the individual results on a diagram.

Although the experiments by McConnell ‡ and Kidd, made in 1888, are of considerable interest and were carried out with skill and accuracy, they have not hitherto been mathematically examined.

They showed that a clear bar of ice, cut out of a single ice crystal, with the optic axis at right angles to the length of the bar, did not yield appreciably to tension. Another bar, having the optic axis parallel with the length of the bar, also failed to lengthen very appreciably under tensile stress. On the other hand, a bar having the optic axes of its numerous long crystals inclined at an angle of 45° lengthened continuously under stress. Taking the mean result for their experiments, given in their table on page 362§, we obtain a viscosity of

$$24.8 \times 10^{12} \text{ poises.}$$

Since the yield must have been at right angles to the optic axes, the high viscosity may be partly due to the low temperature (about -5° C.), to the fact that the bar consisted of a large number of crystalline columns, and that the shear planes were inclined to the direction of the stress.

Several tensile experiments were also made with glacier ice. McConnell and Kidd || remark (p. 333) : " We tested three pieces, which were quite sufficient to disprove the common notions that glacier ice is only plastic under pressure, not under tension, and that regelation is an essential part in the process." These three pieces were composed of a number of crystals varying in thickness from two to three millimetres up to thirty or even a hundred. These crystals

* *Zeitschrift für Gletscherkunde*, iv. p. 380 (1909-10).

† *Geol. Mag.*, Decade v, vol. ix. pp. 265-9 (1912).

‡ *Proc. Roy. Soc.* vol. xlv. pp. 331-367 (1888).

§ *Proc. Roy. Soc.* vol. xlv. 1888. || *Ibid.*

are the "glacier grains" (gletscherkörner), which play such a large part in glacial literature. "Owing to the structure being so complex, we failed to trace any relation between the arrangement of the crystals and the rapidity of extension. It is true that the most rigid of the three was composed of small crystals; but this was perhaps accidental."

In addition to glacier ice they made several experiments on other kinds of ice. Table I. is slightly altered from the table of McConnell and Kidd, given on page 338 of their paper as a summary of their experiments. The last column giving the viscosities has been added. The mean of their results for glacier ice is

$$\eta = 84.5 \times 10^{12} \text{ poises.}$$

In 1899 Blümcke and Hess* published their paper on the Hintereis Glacier. Not only did they observe the velocity of the ice along a number of lines drawn across the glacier, the rate of ablation, and the altitude of its various parts; but, by the help of borings and aided by certain hypothetical considerations, they attempted to construct sections of the glacier showing its width and depth at certain positions. The methods adopted for drawing the sections are open to some objections; but they appear to have used with skill the only methods open to them, and the sections they have thus obtained are probably approximately correct.

The method, Blümcke and Hess state, is a very laborious one; for it involves tracing the stream lines in the ice, and ascertaining accurately the ablation and surface velocity of all points on the glacier tongue. The main objection to their method is that they assume, in the first place, that the velocity is the same in all vertical lines. This would make the glacier too shallow, for the glacier slips bodily and also flows differentially. They then ascertained the actual thickness at certain points by actual borings through the ice, and increased the thickness of the ice everywhere in proportion to the extra thickness thus ascertained. But the velocity at any point on the surface does not depend entirely on the thickness of the ice at that place. The velocity at any point on the surface is affected by the depth of the ice at all points of the section, and to a certain extent on the shape of the undersurface of the glacier above and below the section. However, the sections are the most accurate that have yet been obtained, and great praise is due to Blümcke and Hess for the work they have accomplished.

* *Wiss. Erg.-Hefte z. Zeitschr. d. D. u. Ö. A.-V.* ii., Munich, 1899.

TABLE I.
Extension Experiments.

Experiment No.	Description of specimen.	Duration.	Rate per hour in mm. per length of 10 cm.	Tension kilos. per sq. cm.	Mean temperature.	Viscosity in Poises.
2	Bath ice corrected for temperature.	5½ days	0.0000	4.9	-4°·5 C.	9.3×10 ¹²
3	Mould ice.	28 hours	0.0480	3.8	-5°·0 C.?	88.6
4	Glacier ice A, maximum rate.	5 "	0.0220	1.66	-2°·0	"
4	" " minimum rate.	4 "	0.0130	1.66	-2°·5	150.3
5	Glacier ice B, maximum rate.	24 "	0.0160	2.7	-3°·5	19.9
7	Glacier ice C, maximum rate.	23 "	0.0068	2.55	-4°·5	44.0
7	" " minimum rate.	3 days	0.0013	2.55	-9°·0	231.0
8	Glacier ice D, minimum rate.	16 hours	0.0054	1.45	-10°·0	31.6
8	" " lowest temperature.	12 "	0.0065	1.45	-10°·5	26.2
6	Ice, maximum rate.	5 "	0.0041	2.2	0°·0	63.0
6	" " minimum rate.	8 "	0.0015	2.2	-1°·7	172.0
9	Take ice, parallel to columns.	7 days	0.00039	2.1	-5°·5	900.0
9	" " greater tension.	2 "	0.00076	2.8	-5°·5	433.0
10	Take ice, oblique to columns, max. rate.	6 hours	0.03400	2.75	-5°·8	9.5
10	" " " min. rate.	16 "	0.01000	2.75	-6°·0	32.0

In the present paper we now purpose discussing the data furnished by Blümcke and Hess, with a view to calculating the viscosity of the Hintereis Glacier. Weinberg, as we have seen, has already attempted this, but his result, although it agrees with his torsion experiment on glacier ice, does not agree with the tensile tests of Dr. Main and McConnell and Kidd.

The conditions of flow of viscous fluids are only known for certain shaped channels. The simplest known conditions of flow are along semicircular, elliptic, or channels of great width as compared with depth.

The force producing motion in the case of a glacier is gravity, and it is measured in dynes per cubic centimetre = gravity \times density \times gradient = P .

For glaciers so wide that they may be considered as of infinite width, we have

$$\text{Viscosity } \eta_{\infty} = \frac{Pb^2}{2V}, \quad \dots \dots (4)$$

where η_{∞} is the viscosity without correction for width, b is the thickness of the glacier, and V the maximum surface velocity, all in C.G.S. units.

For semi-elliptic channels the corresponding equation is

$$\eta = \frac{Pa^2b^2}{2V(a^2 + b^2)}, \quad \dots \dots (5)$$

a being the semi-width and b the depth, which is equation (4) multiplied by

$$\frac{a^2}{a^2 + b^2} = F,$$

so that

$$\eta = \eta_{\infty} F. \quad \dots \dots (6)$$

Writing ρ for the ratio $\frac{a}{b}$ we have

$$\frac{a^2}{a^2 + b^2} = \frac{\rho^2}{\rho^2 + 1} = F. \quad \dots \dots (7)$$

It will appear later that the method of considering the true viscosity η to be equal to that obtained by considering the glacier as of infinite width, η_{∞} , multiplied by a factor F depending upon the section of the bed, is convenient in several respects. As ρ , or $\frac{a}{b}$, increases, F , rapidly approaches unity, as is clearly shown in fig. 1 (Pl. III.), so that for wide glaciers of regular thickness the actual width has very little

effect, and they may reasonably be considered as of infinite width. F_e is the factor for an ellipse.

In the case of the Hintereis Glacier the stream is comparatively deep as compared with the width, and the form of section departs markedly from that of an ellipse. Weinberg's method of calculating the viscosity of the Hintereis Glacier was to find an ellipse which is the equivalent of the glacier bed.

From the dimensions of the semi-axes of his ellipse, Weinberg would appear to have used the sections as given by Blümcke and Hess; but although he states the dimensions of the ellipse selected he does not give full details concerning the reasons for his selection.

Fig. 2 (Pl. III.), upper section, shows the glacier section as drawn by Blümcke and Hess*, for their section line V. It also shows Weinberg's ellipse for comparison. It will be seen that the ellipse has about the same sectional area as that of the actual section.

In fig. 2 the upper section is the actual section V. given by Blümcke and Hess, with the positions of the borings and their depths in metres. The lower section gives the glacier section distorted so as to bring the upper surface of the glacier level. It is more convenient to deal with the section in this form, and the slight distortion does not introduce any considerable error. In the lower section the curve *bb* shows the ellipse as fitted to the section by Weinberg, whilst the curve *aaa* shows the glacier section (distorted) of Blümcke and Hess.

Although Blümcke and Hess give nine sections across the glacier, and all these sections were used by Weinberg for calculating the viscosity, only one of these sections is actually based upon borings made through the glacier. All the borings in the upper section fig. 2 are considered to have touched the bottom. In some cases other borings had to be abandoned as they had clearly struck boulders in the ice.

Velocity of Glacier Flow.—The velocity lines given by Blümcke and Hess for the Hintereis Glacier, map fig. 3, are drawn in metres per annum. During the summer, however, the glacier moves faster than it does during the winter. This can scarcely be due to the glacier having a higher temperature during the summer than during the winter. Weinberg suggests that during the summer the sun's heat penetrates the ice, and water is formed in its mass. The ice is thus weakened and the viscosity of the upper portions is decreased.

* *Ibid.*

Changes occur from time to time in the velocity of glacier flow. These changes are intimately connected with their varying advances and retreats, which result from periodical alterations in the amounts of precipitation and ablation or other causes. During retreats of the glacier snout the velocity and thickness decrease, whilst during its advance the velocity and thickness increase.

According to Blümcke and Hess the maximum speed of the Hintereis Glacier at section III. was 34·7 metres in 1893–1894, 41·2 metres in 1894–1895, and 38·7 metres per annum in 1895–1896. This shows that the velocity at the date the measurements were made, 1894–1895, was not quite that of the “steady state.” The velocity corresponding to the steady state occurs at some time between a period of maximum and minimum velocity. It is probable that the velocity taken is rather too great.

Our knowledge of the seasonal variations of glacier flow is by no means complete. The first reliable observations were made by August Balmat, the guide, under the direction of J. D. Forbes*, on the Glacier des Bois, Chamouni, a little below the Chapeau, opposite the Montanvert Hotel, at about one-third of the breadth of the glacier on its eastern side. His results are plotted on fig. 4.

The observations indicated by the crosses were made in 1884, and those by circles in 1885. Some of the observations made in October and November are considerably greater than the velocities shown by the smoothed curve; but from November to March they show a continuously low value. This curve of velocities corresponds very closely with the temperature curve for the same period at Geneva.

Tyndall made some observations along the same section in December 1859. He then found the maximum velocity to be 16 inches per diem. This agrees fairly well with the velocity found by Balmat, viz. 14 inches per diem. Tyndall, however, found the July speed to be $33\frac{3}{4}$ inches, whereas Balmat and Forbes made it 50 inches.

In the summer, no doubt, the velocity varies considerably according to the state of the weather; but in the winter, when the ice is deeply covered with snow, the conditions would be more equable.

From fig. 4 the mean speed is found to be 28·5 inches per diem, the maximum speed about 50 inches in July and the minimum speed 14 inches in December; the maximum speed being about 68 per cent. greater than the mean and the winter rate about 56 per cent. slower than the mean.

* ‘Theory of Glaciers,’ pp. 123–132.

In the case of the Hintereis Glacier, according to Finsterwalder*, the summer velocity for 1900 was only 15 per cent. greater than the average velocity for the two years 1899-1901. The greater difference between the mean and summer velocity of the Glacier des Bois than that of the Hintereis Glacier, may be due to the fact that the former is only 1900 metres above sea-level, whereas the latter, at section V., is 2600 metres above the sea, and the heat of summer has less influence.

Great interest attaches to the winter velocity. We must assume that when during the winter the ice is covered with snow some of the water in the ice congeals. We thus during the winter have the glacier more nearly approaching the dry state.

The actual winter velocity of the Hintereis Glacier does not appear to have been measured. Even in the case of the summer velocity it is not clear whether Finsterwalder's measurement gives the mean summer or maximum summer velocity. It is most probably the maximum. Compared with the Glacier des Bois the winter velocity of the Hintereis Glacier would be $\frac{56 \times 15}{68} = 12.3$ per cent. less than the mean annual velocity. This makes the winter velocity 42.1 metres per annum. We thus have for the maximum velocity of the Hintereis Glacier

Winter velocity	42.1 metres per annum.
Mean annual velocity ...	48.0 " "
Summer velocity	55.2 " "

Slip.—One of the most important and difficult values to ascertain is the amount of slip which takes place between the ice and the rock-bed upon which it rests. There are several ways of estimating this. That glaciers do slip very considerably upon their beds is proved by the striations, grooving, and polishing which are found upon rock surfaces over which glaciers have passed. That they are abrading their beds is also shown by the rock flour and boulders with which the streams issuing from the ice are loaded.

At the edges of glaciers the ice is almost always found to be in motion. In the case of the Hintereis Glacier the marginal velocity, near section V., is about 12 metres per annum, or 25 per cent. of the maximum, and increases very rapidly for the first fifty or sixty metres from the edge. This rapid increase may be due to the fact that, at its edges,

* Hans Hess, 'Die Gletscher,' p. 250.

the ice is very much crevassed and lags behind on that account.

Another method of estimating the slip is to find the amount of slip which brings the actual surface velocity curve into agreement with the theoretical one.

In the absence of a knowledge of the viscosity of the liquid it would be impossible to calculate the actual velocity curve; but although this cannot be done, the form of the velocity curve for certain shaped sections can be obtained with accuracy. In the case of an irregular section, however, such as that of the Hintereis Glacier, this can only be done approximately.

Unfortunately the semicircle or semiellipse is of no use for this purpose; for the form of the glacier section differs markedly from that of an ellipse. Generally speaking, the sectional form of a glaciated valley approaches the parabolic form very closely; but the deepest part is frequently not at the centre.

From equations (4) (5) and (6) we see that for an ellipse

$$V = \frac{Ph^2}{2\eta} \cdot F_e \dots \dots \dots (8)$$

for the central velocity,

where
$$F_e = \frac{\rho^2}{\rho^2 + 1}, \dots \dots \dots (9)$$

and ρ = ratio of semi-width to depth.

If it were possible to find such values for F that the equation could be used at any part of an irregular section, it would be possible to calculate the form of the speed curve for that section. Such a method would be probably a purely empirical one; but if the results obtained for a section, the actual form of the speed curve of which is known, proved approximately correct, the method could then be used with some confidence for the irregular glacier section.

Weinberg experimented with pitch flowing down a channel of the same section as that given by Blümcke and Hess for the Hintereis Glacier. His curve *aa* is shown in fig. 5, upper section, along with the actual glacier velocity curve *bb*. The most striking difference is the fact that the maximum speed of the Hintereis Glacier is to the right (north) of the centre line, whereas the maximum speed of the pitch velocity curve is nearly above the deepest part to the south. This may in great measure be due to the slight curve of the glacier and the direction in which the ice current flows from the *névé* region. The map fig. 3 will explain this. Tyndall showed

that in the case of the Glacier des Bois the locus of maximum velocity was on the outside of the centre line of the curve.

Perhaps the most satisfactory method of procedure for ascertaining the probable slip from these curves, is to compare Weinberg's pitch curve with the actual curve after making them symmetrical mean curves. These are given in fig. 6. With no slip in the case of the pitch curve, the curves do not match at all well. With 74 per cent. slip a more satisfactory agreement is obtained. *a'a'* is the pitch curve obtained by Weinberg, no slip being allowed, and *aa* is the same curve with an allowance of 74 per cent. slip. Using this curve as a guide for the extrapolation of the actual mean curve *bb*, we get a slip of 68·7 per cent.

Considering that the broken ice at the sides must have resulted to some extent in the shoulders *A*, fig. 6, being relieved of resistance, that the upper portion of the ice is "wet" and has a low viscosity, and that the slip at the sides may be less than at the middle, 68·7 per cent. of slip is probably much too great.

The resistance offered to the flow of a glacier is of two kinds (1) the frictional resistance of the floor, and (2) the resistance the ice offers to change of shape. When the form of the floor is regular and smooth the glacier may slide bodily down the valley. Prof. Tarr * thus refers to Fallen Glacier, Alaska. "This glacier . . . lay for the most part in a cirque-like amphitheatre with steeply rising mountain walls at its head." "The glacier was photographed by Russell in 1890." "The amphitheatre has a narrow mouth, out of which the crevassed terminus of the glacier protruded, the lower end terminating at an elevation of about 1000 feet above the fiord." It was estimated to have a length of about a mile. Some Indian guides reported the fall of the glacier, and Tarr found that "the entire glacier had evidently shot out of its valley, tumbled a thousand feet down the steep slope, and entered the fiord, generating a series of pronounced waves." "A half mile south of Fallen Glacier the wave rose 110 feet, breaking off alder bushes at that height." No doubt the fall was greatly assisted by the crevassing of the ice.

The coefficient of friction of a glacier on its bed depends largely upon the presence of rock material embedded in its under surface. Indeed the slip and friction of glaciers must vary greatly with the nature of the rocks over which they flow.

* 'The Yakutat Bay Region of Alaska,' 1909, p. 67.

Very little is known concerning the coefficient of friction of glaciers upon their beds. Indeed it is not clear why a glacier slips at all upon its bed when we consider how slight the slope generally is.

In most glacier valleys there are hollows and hummocks, into which and over which the ice moves. When this is the case the viscosity of the ice assists to prevent the glacier from slipping forwards bodily; for the glacier has to undergo change of form to enable it to slip. The viscosity, therefore, influences the slip to some extent. If clean ice which was melting at the surface of contact rested upon smooth rock, the coefficient of friction would be small. But the bottoms of glaciers are charged with stones, sand, and mud, and it is probable that the resistance to slipping is mainly due to the stony condition of the bottom surface, where, as in the case of the Hintereis Glacier, the valley is of fairly regular section and slope.

In the case of an elliptical channel, such as that shown in fig. 7, the shear force at any point x, y is

$$f = 2\eta V \sqrt{\frac{x^2}{a^4} + \frac{y^2}{b^4}},$$

V being the central velocity.

The pressure at the same point is $p = dy$, d being the density.

Now the slip may be reasonably expected to be directly proportional to the force f producing it, and inversely proportional to the frictional resistance, which latter will be directly proportional to the pressure, so that

$$\begin{aligned} \text{slip} &\propto \frac{f}{dy} \\ &\propto \frac{2\eta V \sqrt{\frac{x^2}{a^4} + \frac{y^2}{b^4}}}{dy}, \dots \dots \dots (10) \end{aligned}$$

or, as $2, \eta, V,$ and d are constants, they may be ignored, and

$$\text{slip} \propto \frac{1}{\eta} \sqrt{\frac{x^2}{a^4} + \frac{y^2}{b^4}}. \dots \dots \dots (11)$$

In fig. 7 the slip-curve cc , calculated according to this formula, has been plotted. It will be seen that it makes the slip somewhat less at the centre than at the sides. At the point c (fig. 6), where the extrapolated curve leaves the actual speed curve bb , the slip is 24 per cent. greater than

at the middle. Accepting 68·7 per cent. as being the slip at the sides, an allowance of 24 per cent. for the slip at the middle gives us 52·2 per cent. as the probable slip at the middle.

Formula (11) does not give accurate results, because it assumes that the slip at one point may be different from that at another point near by without there being any mutual effect. However, the figures, except near the sides, show that the slip-difference is small, and will not seriously affect the figures.

It must be admitted that the results obtained by a consideration of the surface velocity curve do not give results which can be considered very satisfactory; but this has been relied upon by Weinberg for estimating the slip. He, however, took the averages of many sections, instead of confining himself, as we have done, to section V. of Blümcke and Hess, and estimated the slip at about 33 per cent.

Another method of calculating the slip may be based upon some interesting figures given by Blümcke and Hess*. From the rate of ablation they calculated as nearly as possible the volume of ice that was passing at various points on the glacier. They then assumed that the velocity was the same at the bottom as at the surface, and found the thickness of the glacier at various points on this assumption. But as a considerable volume of ice passes down owing to the differential motion of the stream, they knew that the ice must be thicker than the hypothetical value thus obtained. They therefore bored through the glacier at various points and found, as they expected, that the glacier was really thicker. The following Table (II.) gives the results obtained at section V.

TABLE II.

A.	B.	C. Per cent.	D.
1	13·9	31·0	4·31
2	42·4	19·0	8·05
3	45·2	19·0	8·59
4	46·1	4·0	1·84
5	41·7	31·0	12·92
6	46·0	31·0	14·60
7	32·5	10·0	3·20
			<u>7)54·51</u>
			7·79 average metres per annum.

* *Mitt. d. D. u. Ö. A.-V.* no. 4, p. 46 (1905).

This is about 16 per cent. of the average annual velocity.

A = Borings on section V.

B = Surface-speed at boring.

C = Percentage of slip.

D = Slip in metres per annum.

Borings 4 and 5 are on opposite sides of the thickest portion of the glacier, and yet there is a very great difference between the calculated slips at these points. The slips at short distances from the two sides are also much smaller than the actual slips obtained near the edges of the glacier.

Two borings were also made at other points, and Blümcke and Hess consider that the hypothetical thickness of the ice, made on the assumption that there is no differential motion, is 77 per cent. of the actual thickness. Regarding the vertical curve of velocity as a parabola, this would give a slip a little in excess of 31 per cent.

The method of calculation employed to obtain the values given in Table II., column C, is as follows:—

In the diagram (fig. 8) the area AA'CC' gives the volume of ice passing when there is no differential motion, whilst AA'DB gives a similar area when there is a bottom slip of 50 per cent. When the hypothetical depth is 66·6 per cent. of the actual depth there is no slip, and when, for example, the hypothetical depth is 83·5 per cent., the slip is 50 per cent. This is the case when the vertical curve of velocity is a parabola.

But we have given reasons for believing that the mean-speed curve is not a parabola near the surface, owing to the effect of the sun's heat upon the upper portion of the glacier. The conditions are probably more nearly as shown in fig. 9. Here the mean annual curve of velocity is of the form A'B and the winter curve the parabola CD, for we have shown that the winter velocity is probably 12·3 per cent. less than the mean annual velocity. With such a mean annual curve the hypothetical depth would be about 60 per cent. for no slip to take place. But the hypothetical depth, according to Blümcke and Hess, is 77 per cent. Under these circumstances the mean annual curve must be AC (fig. 9) and the slip about 43 per cent. of the mean annual velocity, or 20·64 metres per annum. In the winter the differential motion would be $42·1 - 20·64 = 21·46$ metres per annum. We thus have a winter slip of 51 per cent.

The necessity for getting the slip accurately arises from the fact that to calculate the viscosity it is the difference

between the surface velocity and bottom velocity that must be used in the calculations.

The various estimates of slip are, in per cent. of mean velocity :—

1. Slip at side of glacier	25	per cent.
2. By extrapolation of surface velocity curve ..	68·7	„
3. Above, corrected for probable greater slip at sides	52·2	„
4. Mean of direct comparison of actual with hypothetical depth and parabolic velocity curve	16	„
5. Above, taking 77 per cent. as the hypothetical depth compared with actual depth and parabolic velocity curve	31	„
6. As above, but with lesser surface viscosity ..	43	„
7. As above, for winter	51	„

The last result appears to give the most accurate result, and we shall use in our calculations a winter velocity of 42·1 metres per annum and a slip of 21·46 metres per annum, giving a differential shear velocity of 20·64 metres per annum, or 0·0000654 cm. per second.

Force Producing Motion.—The force producing motion results from the slope of the glacier. If the glacier were of equal thickness longitudinally the slope of the bed would be equal to that of the surface. But in the region of ablation the glacier generally gets thinner and thinner the farther it is followed down the valley. It is a question, therefore, which figure should be used, that giving the slope of the glacier bed or that giving the slope of the glacier upper surface.

With regard to the slope of the bed, this can only be obtained by empirical methods. But even when the bed is flat, if there is a slope of the upper surface the ice flows in the direction of the slope. It is clear from this that it is the slope of the upper surface of the ice which is most important, and as this can readily be obtained with accuracy, we shall consider the downward component of gravity as being proportional to the slope of the upper surface of the glacier. The difference between the slope of the upper surface and that of the glacier bed cannot differ very much, so the error introduced cannot be large.

Fig. 10 shows a plan, after Blümcke and Hess, of the Hintereis Glacier tongue both above and below section V. Sections IV. and VI. are 600 metres apart, and four lines

near the middle drawn in the direction of the stream-lines give the following heights above the sea :—

Section IV.	Section VI.
2587	2640
2592	2646
2593	2648
2591	2647
4)10363	4)10581
2590·8	2645
	2590·8
	54·2 metres.

We thus have 54·2 metres fall in 600 metres, or a slope of 9 in 100.

Weinberg gives the slope as 17 in 1000 for this section, a much smaller figure. How he obtained it is not stated.

Viscosity of the Glacier Ice.—We have seen that Weinberg calculated the viscosity by fitting to the section of the glacier a semi-ellipse which he regarded as the equivalent of the actual glacier section. We purpose giving a method by which the ellipse may be very accurately fitted to the channel. A form of curve will also be described, and used for calculating the viscosity, which resembles that of a glaciated valley section much more closely than does an ellipse.

The error that may result from the matching of the ellipse to the actual section arises from the fact that, although the areas may be the same, the deep central channel of the Hintereis Glacier has a much greater effect upon the flow than a similar cross-section area high on the sides. However, the error is only serious when the flux has to be calculated.

The method adopted for fitting the ellipse to the actual valley-section will now be described.

Fig. 11 is intended to represent a portion of the side of a glacier of considerable width. Here the surface velocity is proportional to the square of the depth, or to x^2 , and we may take it that the effect of other portions of the bed on each side of the line AB has no influence on the velocity at A, when the glacier bed is flat. When the lower surface is not flat the velocity at C is considerably influenced, and it is desirable to ascertain, as near as possible, what this influence is. When the channel is elliptical

$$\eta = \frac{fb^2a^2}{2V(a^2+b^2)} \cdot \cdot \cdot \cdot \cdot \quad (12)$$

If $\frac{a}{b} = \rho,$

then $\eta = \frac{f \rho^2 b^2}{2V(\rho^2 + 1)}, \dots \dots \dots (13)$

so that the velocity as determined for a definite thickness b , and a definite velocity V , will be affected by the ratio of semi-width to depth according to

$$F_e = \frac{\rho^2}{\rho^2 + 1}.$$

We thus obtain

$$\eta = \frac{f b^2}{2V} \cdot F_e, \dots \dots \dots (14)$$

F_e being the ratio of the true viscosity to the viscosity obtained by considering the section to be of infinite width ;

or $\eta = \eta_\infty F_e,$

where η = true viscosity,

η_∞ = viscosity for infinite width,

F_e = factor depending on proportions of the ellipse.

We will suppose (fig. 11) that the effect of each portion of the glacier bed affects the central velocity V in the proportion of $\frac{x^2}{y^2}$, and that the total effect is proportional to the mean value of a number of radials calculated in this way = F_a . On a flat bottom, for instance, all radials will have the value a^2 , whilst the effect of radials high up on the sides, when the glacier is broad, will be very small. The method gives accurate results for a semicircular channel, and is fairly accurate for ellipses. For some other sections, such as V , it is not so accurate.

But although the method does not give correct results, except for certain sections, it gives exceedingly good comparisons between sections which do not differ much from each other in shape.

In fig. 5 the lower section shows the glacier bed, and above it are the values of F_a , calculated by the $\frac{x^2}{y^2}$ mean radial method, the value of F_a for the centre of the glacier being 0.651. Above the section of the glacier are drawn the surface-velocity curve bb and Weinberg's curve aa for pitch.

For the viscosity of the Hintereis Glacier we therefore have

$$\begin{aligned} P &= \text{bodily force producing motion, being downward} \\ &\quad \text{component of gravity,} \\ &= \text{gravity} \times \text{density} \times \text{gradient,} \\ &= \frac{981 \times 0.9 \times 9}{100} = 79.46. \quad \dots \dots \dots (15) \end{aligned}$$

The value of F_e for the shallow ellipse used by Weinberg is 0.821, and that for the deeper ellipse we have used 0.725. The viscosities in the two cases would be proportional to $156^2 \times 0.821$ and $179^2 \times 0.651$, or to 19,779 and 23,229 respectively. This shows that the deeper section, although of the same area as the actual section, gives the greater viscosity.

To obtain the most accurate value for F , the better plan is to obtain the $\frac{x^2}{y^2}$ mean radial value F_E for the deep ellipse and ascertain the extent to which it differs from the $\frac{x^2}{y^2}$ mean radial value F_a for the actual section. F_e can then be corrected in this proportion. This would be a more satisfactory method if the ellipse agreed more nearly in form with the actual glacier section. We thus have

$$\begin{aligned} F_e \times \frac{F_a}{F_E} &= 0.725 \times \frac{0.651}{0.622} \\ &= 0.7588. \quad \dots \dots \dots : (16) \end{aligned}$$

Using this value of F for the deep section,

$$\eta = \frac{79.46 \times 17900^2}{2 \times 0.0000654} \cdot 0.7588 = 147.7 \times 10^{12}. \quad \dots (17)$$

F_a and F_E are both somewhat in error, but their ratio is probably fairly near to the truth; therefore, knowing the true value of F_e from $\frac{\rho^2}{\rho^2 + 1}$, we have used the ratio $\frac{F_a}{F_E}$ as a means of deducing the probably correct value of F for the deep ellipse fitted to the actual section of the Hintereis Glacier.

Although it is possible to use the above formulæ for calculating the viscosity, the flux cannot be accurately obtained from the figures; for all ellipses of equal area to that of the section will not pass the same volume of ice that the actual section will. Weinberg's ellipse, for example, is

too shallow. The additional area obtained at the sides does not compensate for the absence of the deep channel near the centre. The deeper section we have fitted gives a more accurate result.

So far we have not succeeded in devising a method on similar lines to the $\frac{x^2}{y^2}$ radial method, for fitting an ellipse to the section which will give a channel of equal area to the actual one, and at the same time one that will pass an equal volume of ice.

The most reasonable method is to use formula (17).

$$\frac{\pi \times 79.46 \times 29100^3 \times 17900^3}{8 \times \eta \times (29100^2 + 17900^2)} = \text{flux.}$$

In addition to the flux due to differential flow the volume which moves down owing to the bodily slip of the glacier must also be added. This, for the winter flow, can be approximately calculated as follows :

$$\text{Bodily flux} = \frac{22100 \times 17900 \times 3.1416 \times V_1}{2} \dots (18)$$

Here V_1 is the mean velocity. This can only be obtained approximately, as the exact variation of the velocity from the centre to the sides is not known.

For the summer flux, the additional volume passed owing to the lower viscosity of the surface portions of the ice must be added. This quantity is also uncertain, but it forms only a small portion of the total flux.

Although for the calculation of the viscosity an ellipse gives fairly satisfactory results, this form of curve does not fit an actual glaciated valley at all satisfactorily. On this account the speed curve given by an ellipse varies very greatly from that of the surface-velocity curve of a glacier. We have, therefore, attempted to discover a form of curve which agrees more closely with the section of a glaciated valley. Although such a curve has been found, and is described in the Appendix to this paper, the rather abnormal form of the section of the Hintereis Glacier renders it, for our present purpose, not quite so useful as it may be in other cases. We might here suggest the advisability of making another boring through the glacier, on section V., near the one which shows a thickness of 163 metres. If this boring should thus be proved to have struck a stone and not reached the bottom, the surface-velocity curve may not be quite as abnormal as it now appears to be.

Generally speaking, the form of well glaciated valleys very closely approximates to a parabola. Fig. 12 gives two sections across valley No. 7 in the Bighorn Mountains of Wyoming. This form may be described as a lop-sided parabola. Unfortunately the conditions of viscous flow have not been ascertained for a parabolic channel.

For the curve we have referred to, which we have called Parr's curve, the depth at the centre is

$$\sqrt{\frac{\beta - \sqrt{\beta^2 - 4}}{2}} \dots \dots \dots (19)$$

If a be the semi-width of the channel, and b its depth at the centre, we have

$$\alpha = \frac{2}{a^2}, \quad \beta = \frac{a^4 + b^4}{a^4 b^4} \quad \text{and} \quad V = \frac{P}{2\eta} \cdot \left(\frac{a^2 b}{a^2 + b^2} \right)^2, \quad (20)$$

V being the velocity at the centre.

The curves given by the equation (see Appendix) will be found to approximate very closely indeed to natural glaciated valleys, most of which can be fitted very accurately by a proper choice of the constants β and c . β settles the depth of the section and c the amount of lopsidedness.

In fig. 13 a curve aaa of this nature has been fitted to the section of the Hintereis Glacier. It will be seen that it has the same area as the actual section, and that the deepest parts of the two sections coincide. Here $\beta = 3.5$ and $c = 2$.

According to this curve

$$\begin{aligned} \eta &= \frac{P}{2V} \cdot \left(\frac{35800^2 \times 19900}{35800^2 + 19900^2} \right)^2 \\ &= \frac{79.46}{2 \times 0.0000654} \times \left(\frac{35800^2 \times 19900}{35800^2 + 19900^2} \right) \times \left(\frac{35800^2}{35800^2 + 19900^2} \right). \end{aligned} \quad \dots \dots \dots (21)$$

Here

$$\frac{35800^2}{35800^2 + 19900^2} = F_p.$$

Correcting the value of F_p in the same manner as was adopted for F_e , we have

$$F_p \times \frac{F_a}{F_p} = 0.764 \times \frac{.526}{.586} = .685, \quad \dots \dots \dots (22)$$

and

$$\eta = \frac{79.46}{2 \times 0.0000654} \times \left(\frac{35800^2 \times 19900^2}{35800^2 + 19900^2} \right) \times .685. \quad (23)$$

$$= 125 \times 10^{12} \text{ poises.}$$

The upper curve of fig. 13 is the surface-speed curve calculated by the formula below,

$$w = \frac{1}{2}x^5 + x^4 - x^3 - 2x^2 + \frac{1}{2}x + 1.$$

It will be seen that this curve very closely resembles the one obtained by Weinberg for pitch.

We have not as yet obtained the formula for the flux of Parr's curve.

The great defect of the ellipse as a basis for comparison lies in the fact that the boundary is vertical at the sides (for the solution has only been found for the complete semi-ellipse), whilst the sides of a natural valley are sloping. This makes an enormous difference to the shape of the surface-velocity curve near the sides.

Summary.—Table III. gives the results of the various calculations which have been made of the viscosity of glacier ice, with the names of the experimentalists and dates.

TABLE III.

Experimentalist.	Date.	Calculated by	Date.	Viscosity.
Dr. Main	1888	R. M. Deeley ...	1912	6.0×10^{12}
McConnell & Kidd ...	1888	R. M. Deeley	84.5×10^{12}
Boris Weinberg	1907	B. Weinberg.....	1907	8.0×10^{12}
Blümcke & Hess	1907	B. Weinberg.....	1906	17.4×10^{12}
Tyndall & others	R. M. Deeley ...	1908	78.9×10^{12}
Blümcke & Hess	1910	B. Weinberg.....	1910	17.5×10^{12}
" " 	Deeley & Parr ...	1913	147.7×10^{12}
" " 	Deeley & Parr ...	1913	125×10^{12}

The last two results give the winter viscosity, which is probably that for the glacier in an equally dry condition from top to bottom, and is based upon the best data so far obtained of the velocity and form of a glacier tongue.

The main reasons why our figures for the viscosity are so much greater than Weinberg obtained are, that the velocity we take is much less, more slip being allowed, our slope for the ice is much greater and the viscosity is the winter value.

APPENDIX.

On the Steady Flow of a Viscous Fluid along a Uniform Channel under the action of Gravity.

Taking the origin at the centre of the surface, and using rectangular axes, let x be the horizontal distance from the central vertical plane, y the distance below the surface, at right angles to that surface, and z the distance from the xy plane through the origin, along the stream-lines; also let u, v, w be the velocities parallel to the three axes. Then the mathematical conditions are

$$u=v=0, \quad \frac{\partial w}{\partial z}=0. \quad . \quad . \quad . \quad . \quad (24)$$

$$\nabla^2 w = -\frac{P}{\eta}, \quad . \quad . \quad . \quad . \quad . \quad (25)$$

where

$$\nabla^2 \equiv \frac{\partial^2}{\partial x^2} + \frac{\partial^2}{\partial y^2}. \quad . \quad . \quad . \quad . \quad (26)$$

P = the bodily force producing motion or $g\rho \sin \phi$, ρ being the density and ϕ the angle made by the axis of z with the horizontal, and η = the coefficient of viscosity, taken all over the section, and subject to the conditions that

$w=0$ at all points on the boundary of the section, and

$$\frac{\partial w}{\partial y} = 0, \quad \text{when } y=0. \quad . \quad . \quad . \quad . \quad (27)$$

It is advantageous, from the analytical point of view, to have uniform conditions all round the boundary, and this may be secured by considering the channel to be the lower half of a symmetrical tunnel, the upper half being the reflexion, about the surface, of the lower half.

If the section of the tunnel is taken arbitrarily, the differential equation does not usually admit of a solution in finite terms; the best procedure, therefore, is to study a velocity distribution which is known to satisfy the differential equation, and to determine the particular forms of tunnel which it includes.

The first expression which naturally presents itself is

$$w = K(1 - \alpha x^2 - \beta y^2), \quad . \quad . \quad . \quad . \quad (28)$$

which satisfies $\nabla^2 w = -\frac{P}{\eta}$ if

$$K = \frac{P}{2\eta(\alpha + \beta)}, \text{ K being the central surface velocity,}$$

and the tunnel is the ellipse with semi-axes $\frac{1}{\sqrt{\alpha}}, \frac{1}{\sqrt{\beta}}$.

To this may be added any function of x and y which satisfies $\nabla^2 f(x, y) = 0$.

In order to find the best functions to use, we notice that since the tunnel must be symmetrical in order to admit of the half of it being considered a channel, even powers only may be used for y . If the powers of y are the square and fourth only, the whole function will be a quadric in y^2 , and so will offer no analytical difficulties.

Limiting ourselves to even powers of y not exceeding the fourth, we find the most general expression for the curves of equal velocity ($w = \text{constant}$) to be

$$0 = C - \alpha x^2 - \beta y^2 + \gamma x + \delta(x^3 - 3xy^2) + \epsilon(x^4 - 6x^2y^2 + y^4) + \zeta(x^5 - 10x^3y^2 + 5xy^4), \dots \quad (29)$$

$$\text{or} \quad 0 = (\epsilon + 5\zeta x)y^4 - (\beta + 3\delta x + 6\epsilon x^2 + 10\zeta x^3)y^2 + (C + \gamma x - \alpha x^2 + \delta x^3 + \epsilon x^4 + \zeta x^5) \dots \quad (30)$$

where $C = 1 - \frac{w}{K}$ and the tunnel, for which $w = 0$, is given by $C = 1$.

As this equation has not previously been named it is proposed to call it Parr's equation, and the curves represented by it Parr's curves.

The equation represents a great variety of curves, and the complete analysis has not been made as yet. For present purposes, in order to obtain a channel approximating closely to a natural valley, the equation must be of the form

$$(x+a)^2(x-a)^2(x+c) \text{ when } y=0,$$

$$\text{or} \quad 0 = x^5 + cx^4 - 2a^2x^3 - 2a^2cx^2 + a^4x + a^4c,$$

and $\alpha, \gamma, \delta, \epsilon,$ and ζ may be determined by equating coefficients, β and c being arbitrary.

As we are only concerned with the shape and not the actual size of the curve, we may put the semi-width of the channel equal to unity, or $a = 1$, and combining this with

C=1 and solving the equation for y , we obtain as the section of the channel

$$y = \sqrt{\frac{\frac{10}{c}x^3 + 6x^2 - \frac{6}{c}x + \beta - \sqrt{\frac{80}{c^2}x^6 + \frac{96}{c}x^5 + \left(32 - \frac{80}{c^2}\right)x^4}}{2 + \frac{10}{c}x}}$$

$$+ \left(\frac{20\beta - 24}{c}\right)x^3 + \left(\frac{16}{c^2} + 12\beta + 8\right)x^2 - \left(\frac{12\beta + 24}{c}\right)x + (\beta^2 - 4) + (\beta^2 - 4), \quad (31)$$

and the surface velocity, when $y=0$, is given by

$$w = \frac{1}{c}x^5 + x^4 - \frac{2}{c}x^3 - 2x^2 + \frac{1}{c}x + 1, \quad \dots \quad (32)$$

which depends on c only.

The depth of the centre is

$$\sqrt{\frac{\beta - \sqrt{\beta^2 - 4}}{2}}.$$

If a is the semi-width of the channel, and b its depth at the centre, we have

$$\alpha = \frac{2}{a^2}, \quad \beta = \frac{a^4 + b^4}{a^2b^2}, \quad \dots \quad (33)$$

and

$$K = \frac{P}{2\eta} \left(\frac{a^2b}{a^2 + b^2}\right)^2 \dots \quad (34)$$

The curves given by the above equation will be found to approximate very closely indeed to natural glaciated valleys, most of which can be "fitted" very accurately by a proper choice of the constants β and c . The Hintereis valley, as given by Blümcke and Hess, agrees very well with $\beta=3.5$, $c=2$, as shown in our preceding paper.

If $c = \infty$, the channel becomes symmetrical, and the curves are special cases of an equation considered by Gratz*, but he unfortunately did not discover this, the most important special case, but only considered the curvilinear-square and cruciform tunnels included in the equation.

In order to obtain a useful curve c must be greater than 1, and β greater than a certain limiting value which depends upon the value of c , but which is greater than 2 unless c is infinite.

* "Ueber die Bewegung von Flüssigkeiten in Röhren," *Zeitschrift für Mathematik und Physik*, xxv. p. 5.

The flux along the channel may be found by expressing y as a power series in x and integrating

$$\iint w \, dx \, dy,$$

or by an approximate numerical evaluation in any special case. This has not yet been done, and the purposes of this paper are more to indicate what has already been done, and to point out what appear to be the most promising methods for future advancement, than to attempt any complete solution of the problem.

It appears that the steady flow along a valley may be completely solved by the procedure indicated above, so long as the stream-lines are all parallel; the next question requiring attention refers to the case where the stream-lines are not parallel, but the stream becomes deeper or shallower as it proceeds. This may be due to ablation or alteration of slope. But the mathematical difficulties are very great.

IV. *Range and Sharpness of Resonance under Sustained Forcing and their Variations with Pitch.* By EDWIN H. BARTON, D.Sc., F.R.S.E., Professor of Experimental Physics, University College, Nottingham*.

CONTENTS.

	Page
INTRODUCTION	111
MATHEMATICAL THEORY.	
Equations for Forced Vibrations	113
Response under Damped and Sustained Forcing ...	114
Resonance, its Range and Sharpness	117
Graphs for Range and Sharpness of Resonance	119
Range of Resonance nearly proportional to Decrement.	120
Helmholtz's Theory for the Ear	122
Bjerknes on Electric Resonance	123
Zenneck on Sharpness of Resonance	124
Raman on Maintenance of Oscillations	124
ILLUSTRATIVE EXPERIMENTS.	
The Double Pendulum	125
Melde's Experiment, with constant tension	127
Do. do. with constant number of segments.	129
Helmholtz's Experiment	130
Adjustable Resonator and Forks	132
Brass Instruments	133
Possible Electrical Examples	141
SUMMARY	143

FUNDAMENTAL in the theory of resonance is the result that the response is fuller when the tuning between force and responding system is closer. Further, it is well known

* Communicated by the Author.

that the diminution of resonance for a given mistuning depends upon the damping of the responding system. The resonance is said to be *sharper* when this damping is small. Or, we might say that the *range* of resonance is *greater* when the damping is large.

This dependence of sharpness of resonance on damping is explained in the mathematical treatment of forced vibrations, and is often touched upon even in semi-popular descriptions.

There appears, however, to be another factor affecting the range of resonance, viz. the *pitch or frequency* of the vibrations which one endeavours to elicit. And, when the harmonic impressed forces are *sustained*, this second factor is just as fundamental and inevitable in its influence as the first. But, whereas the effect of the damping is familiar to all students of forced vibrations, that of the pitch seems, up to now, to have escaped all widespread recognition, if even it has been understood by a few. Yet its theoretical derivation and expression are of the simplest. For it is implied in any of the equations used as a solution for vibrations under sustained forcing. Accordingly these only need rightly handling for the clear exhibition of the relation which apparently has been so often overlooked.

It will thus be shown that the range of resonance, which varies directly as the damping coefficient, *also varies inversely as the frequency.*

The application of this principle extends to any cases of sustained forced vibrations whether mechanical, acoustical, or electrical.

The object of the present paper is to sketch the necessary theory and illustrate it by a few experiments. These, though apparently simple, are often somewhat complicated, and need this principle as a clue to their explanation or more suitable arrangement. It will thus be found that the principle under discussion throws light upon some apparently anomalous notes obtainable on certain brass instruments.

It may be noted here that several writers have shown that the character of the resonance is a function of the logarithmic decrement of the responding system. But the decrement appears to have been treated as a single quantity measuring the damping. The possibility of changing the logarithmic decrement, and therefore the sharpness of resonance, by a change in frequency, the damping coefficient remaining constant, seems to have escaped their attention.

MATHEMATICAL THEORY.

Equations for Forced Vibrations.—Let a particle of mass m of the responding system have a restoring force s per unit displacement along the axis of y , resistance r per unit velocity, and be under the action of a damped harmonic impressed force $Fe^{-ht} \sin nt$.

Then the equation of motion may be written

$$m \frac{d^2y}{dt^2} + r \frac{dy}{dt} + sy = Fe^{-ht} \sin nt. \quad \dots (1)$$

Though we shall be concerned chiefly with sustained harmonic forces, it is well to begin with damped ones and note the distinction, as this is required for the elucidation of some of the experiments.

Further, as reference will be made to electrical vibrations, it is desirable to make the work more general by writing here the equation of motion applicable to them also. Thus, if a quantity Q of electricity is on one plate of a condenser of capacity C which is connected to the other plate by a circuit of resistance R and inductance L , the system being under the damped harmonic forcing $Ee^{-ht} \sin nt$, we may write

$$L \frac{d^2Q}{dt^2} + R \frac{dQ}{dt} + \frac{Q}{C} = Ee^{-ht} \sin nt, \quad \dots (2)$$

provided that the mutual inductance between the circuits is small.

Dividing each of these equations by the coefficient of its first term and then introducing new symbols for the quotients thus arising, we reduce them to the common form:—

$$\frac{d^2y}{dt^2} + k \frac{dy}{dt} + p^2y = fe^{-ht} \sin nt, \quad \dots (3)$$

where $y = a$ displacement of a particle, or a quantity of electricity,	}	
$k = \frac{r}{m},$ or $\frac{R}{L},$	}	. . . (4)
$p^2 = \frac{s}{m},$ or $\frac{1}{CL},$		
$f = \frac{F}{m},$ or $\frac{E}{L},$		

The solution of (3) is well known to be the sum of the
Phil. Mag. S. 6. Vol. 26. No. 151. July 1913. I

forced and natural vibrations of the system. We may thus write it

$$y = y_1 + y_2, \dots \dots \dots (5)$$

where

$$y_1 = \frac{fe^{-ht} \sin (nt - \delta)}{\sqrt{\{h(h-k) + p^2 - n^2\}^2 + (k-2h)^2 n^2}} \left. \begin{array}{l} \\ \\ \end{array} \right\} \dots \dots \dots (6)$$

$$\tan \delta = \frac{(k-2h)n}{h(h-k) + p^2 - n^2}$$

and

$$y_2 = Ae^{-kt/2} \sin (qt - \alpha), \left. \begin{array}{l} \\ \\ \end{array} \right\} \dots \dots \dots (7)$$

in which

$$q^2 = p^2 - \frac{k^2}{4}$$

A and α are arbitrary constants which must be chosen in accordance with the initial conditions.

We are chiefly concerned with equations (6), which express the forced vibrations or the response of the system to the impressed forces.

Response under Damped and Sustained Forcing.—As a gauge of the fulness of resonance or response we may take, as done by Lord Rayleigh (*'Theory of Sound,'* vol. i. p. 47, 1894), the kinetic energy possessed by the responding system at the instant of its passage through the position of equilibrium expressed by $y_1 = 0$. To compute this we need the first differential of y , and must then take its value when $y_1 = 0$. Thus

$$\left(\frac{dy_1}{dt}\right)_{y_1=0} = \frac{nfe^{-ht}}{\sqrt{\{h(h-k) + p^2 - n^2\}^2 + (k-2h)^2 n^2}} \dots \dots \dots (8)$$

Then, for the kinetic energy, T' say, we take half the square of this quantity, since it denotes the velocity of unit mass or the electric current through unit inductance. Hence we find

$$T' = \frac{\frac{1}{2} f^2 e^{-2ht}}{\left\{ \frac{h(h-k) + p^2 - n^2}{n} \right\}^2 + (k-2h)^2} \dots \dots \dots (9)$$

But the numerator on the right is the *mean square* of the impressed force. Hence, dividing out by this we obtain the *kinetic energy per unit forcing*. This may be termed the *response* of the system under *damped forcing* and denoted by N' . It is obviously given by

$$N' = \frac{n^2}{\{h(h-k) + p^2 - n^2\}^2 + (k-2h)^2 n^2} \dots \dots \dots (10)$$

When the harmonic impressed forcing is of *sustained amplitude*, we have $h=0$, and so may obtain from (9) and (10) the simplified expressions for the corresponding values of the kinetic energy T and response N. The response under sustained forcing may accordingly be written

$$N = \frac{1}{\left(\frac{p}{n} - \frac{n}{p}\right)^2 p^2 + k^2} \dots \dots \dots (11)$$

Or, calling the quantity in brackets the *mistuning* and denoting it by M, we obtain the compact expression

$$N = \frac{1}{M^2 p^2 + k^2} \dots \dots \dots (12)$$

where

$$M = \pm \left(\frac{p}{n} - \frac{n}{p}\right) \dots \dots \dots (13)$$

It may be noted further that if the forcing is damped in such wise that $h=k$, then again the same simplification of the response occurs as if h were zero ! This is seen on reference to equation (10).

Again, if the damping expressed by h is known to be very small, then equations (11) and (12) may be held as close approximations to the phenomena occurring.

Referring then to the value of the response stated in equations (12) and (13) as the expressions with which we are mainly concerned, we note at this stage that for any system with given constant damping coefficient ($k/2$) but capable of vibrations of various frequencies ($p/2\pi$ and multiples of this), then for N constant the *mistuning* M *varies inversely as the frequency*. That is, the mistunings allowable in eliciting the various responses of different frequencies in the harmonic series vary inversely as the frequencies of the different tones which it is sought to elicit.

This applies to the various possible musical tones of a string or pipe, or to the electrical oscillations possible on certain circuits. We may write this relation in the form

$$Mp = \text{constant for both N and } k \text{ constant.} \dots (14)$$

It is obvious from (12) that N reaches its maximum value, N_0 say, for $M=0$, when

$$N_0 = \frac{1}{k^2} \dots \dots \dots (15)$$

Thus, for any given constant value of k , all curves for different p 's, but with corresponding values of M and N as

abscissæ and ordinates respectively, have the same maximum central ordinate.

Such curves, for frequencies proportional to the first six natural numbers, are plotted in fig. 1, and so represent the responses (by these tones of the harmonic series) to the approximate forcings.

Fig. 1.—Resonance Curves for Commensurate Frequencies.

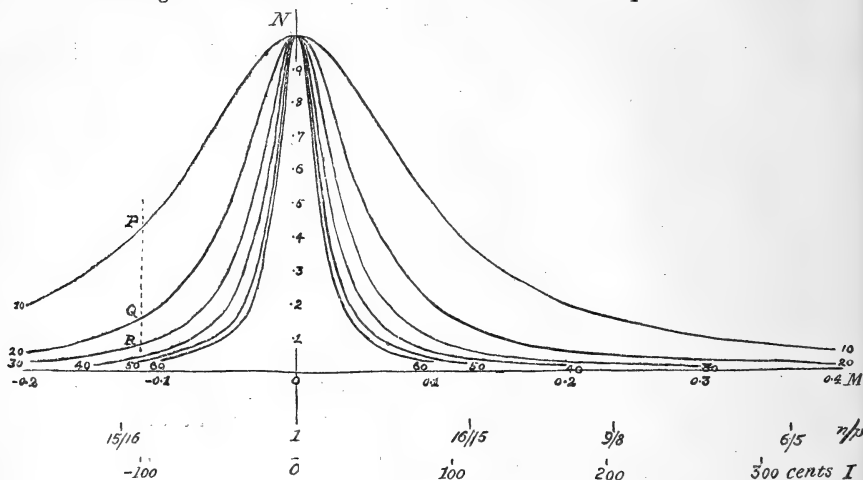

The diagram also shows clearly the force of equation (14). Thus, taking in it a horizontal line at any level, we find that the values of M for the intersections of the different curves are inversely as the frequencies to which they refer. Indeed, any lower curve might be derived from any upper one by proportional shrinkage of all its abscissæ; or, by projection, after it had made a determinate rotation about the axis of ordinates. Each curve has two points of inflexion, which all occur at the same level, viz. at the height of three-fourths of the maximum ordinate.

The apparently strange way of measuring the mistuning, equation (13), which, however, the analysis almost forced upon us, is now seen to have the advantage of yielding a symmetrical resonance curve. Further, for *small* values of this mistuning we have the relation

$$M = 2 \log_e \left(\frac{n}{p} \right), \text{ nearly. (16)}$$

And we know that to measure musical intervals by the *logarithms of their frequency-ratio* is the only mode that makes

the sum of measures of separate intervals equal to the measure of the whole or resultant interval.

It may be noted that if the interval n/p be called I logarithmic cents, of which 1200 make the octave, we have

$$I = \frac{1200}{\log 2} \log \left(\frac{n}{p} \right), \quad \left. \vphantom{I} \right\} \quad (16a)$$

whence $I = 867 M$ nearly, for small intervals.

The values of n/p and I are indicated along the base of fig. 1, below the values of the mistuning M.

Resonance, its Range and Sharpness.—By reference to any of the resonance curves in fig. 1, it is evident that the mistuning allowable for any given value of resonance measures in a certain way the range of resonance under the circumstances represented by that curve. But since this degree of resonance may be chosen more or less arbitrarily, it is difficult to found on this plan a standard measure of the range.

Further, the measurement must be such that the range derived from a given resonance curve would have the same value whether that range of resonance were estimated:—

- (i.) As directly proportional to the mistuning allowable for any given diminution of response, or
- (ii.) As inversely proportional to the diminution of response involved by any given mistuning.

And the method of estimating the diminution of response to make the second alternative harmonize with the first is in no wise arbitrary, being precisely dictated by the curve itself, whose coordinates are the M and N of equations (12) and (13). This method may accordingly serve to measure the range in a standard manner. Following this clue, we find from equations (12) and (15)

$$\frac{N_0 - N}{N} = \left(\frac{1}{k^2} - \frac{1}{M^2 p^2 + k^2} \right) (M^2 p^2 + k^2) = \frac{M^2 p^2}{k^2} = D^2, \text{ say,} \quad (17)$$

where $D = \sqrt{(N_0 - N) \div N}, \dots \dots \dots (18)$

and may be called the *diminution of resonance or response* corresponding to the mistuning M.

Hence, if G denotes the *range of resonance, defined as the quotient of mistuning and the corresponding diminution of response*, we have from equation (17)

$$G = \frac{M}{D} = \frac{k}{p} \dots \dots \dots (19)$$

Or, in other words, the *range of resonance* of a system

under sustained forcing varies directly as its damping coefficient and inversely as the frequency of the vibrations which it is sought to elicit from it.

And of the various ways of estimating the range, this appears to be the simplest which is quantitative, standard, and general. It is accordingly employed in what follows, and is respectfully submitted for general adoption.

Its reciprocal, *the diminution of response per unit mistuning*, we may fitly call the *sharpness of resonance (or response)*. Denoting it by H , we have

$$H = \frac{D}{M} = \frac{p}{k} \dots \dots \dots (20)$$

As equations (19) and (20) are expressed very compactly by symbols which denote functions of other quantities, it may be well to expand them a little and recapitulate somewhat. We may thus write

$$G = \frac{\left(\frac{n}{p} - \frac{p}{n}\right)}{\sqrt{(N_0 - N) \div N}} = \frac{k}{p} = \frac{1}{H} \dots \dots (21)$$

In this equation, $n/2\pi$ is the frequency of the impressed force (of sustained amplitude) and of the forced vibrations, $p/2\pi$ is the frequency that the natural vibrations of the responding system would have *if free from friction*, $k/2$ is the damping coefficient expressing the friction actually present in the responding system, N is the kinetic energy of the responding system (at the instant when its potential energy vanishes) per unit value of the mean square of the impressed force, N_0 is the maximum value attained by N and occurs for $n=p$. It must be carefully borne in mind that these simple values of range and sharpness are only valid for the resonance under *sustained* forcing.

We may now inquire what are the dimensions, if any, of the range and sharpness of resonance. It is easily seen that D and M are each of no dimensions, so that their quotients G and H must be pure numbers also. If the equations (1), (2), (3), and (4) are referred to, we find that, both in their mechanical and electrical uses, k and p are each of dimensions *minus-one in time*. This shows again that their quotients are pure numbers.

If preferred, the range and sharpness of resonance may be regarded as the tangent and cotangent respectively of an angle, ϕ say, which may be called the *angle of resonance*.

We should then have

$$G = \tan \phi = \frac{k}{p} = \frac{1}{H} \dots \dots \dots (22)$$

Reverting to fig. 1, it may now be noted that the various curves have the following values of range and sharpness:—

$$\left. \begin{array}{l} G = 0.1, \quad 0.05, \quad 0.03, \quad 0.025, \quad 0.02, \quad 0.016 \\ H = 10, \quad 20, \quad 30, \quad 40, \quad 50, \quad 60 \end{array} \right\} \dots (23)$$

These, it will be seen later, approximate to some of the experimental examples to be noticed. In the diagram the values of H are inserted at the ends of the curves.

Graphs for Range and Sharpness of Resonance.—It is obvious from the expressions found for G and H (see equations (21) and (22)), that when k is constant and p plotted as abscissæ, the graph of G is the rectangular hyperbola $xy = k$, while that of H is the straight line $y = x/k$.

Fig. 2.—Graphs for Range and Sharpness showing their Variation with Pitch.

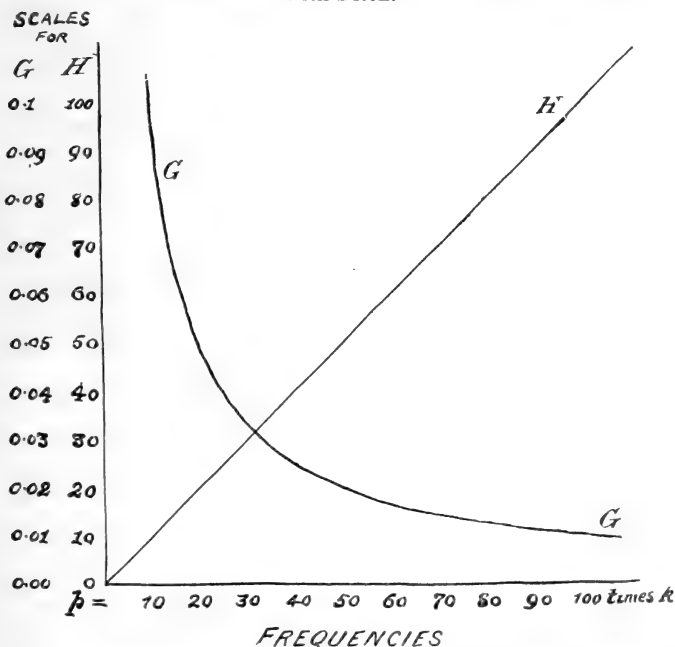

These are shown in fig. 2 over about the same ranges as in fig. 1 and equation (23). Different scales of ordinates are adopted for G and H to bring both conveniently into the same diagram.

Let us now plot a number of resonance curves, each of the type shown in fig. 1, but with their central ordinates separated and distributed according to the natural pitches of the responding system, to which the various curves correspond. As previously mentioned, the only way to plot musical intervals consistently to scale is to measure those intervals by the logarithms of their frequency ratios. And this method will serve for the abscissæ of each of our resonance curves as well as for their distance apart. For, as we saw in equations (16) and (16 a), the *mistuning* which is used as the abscissa is nearly proportional to the *logarithm* of the ratio of the frequencies characterizing the force and the responding system.

Fig. 3.—Harmonic Series of Resonance Curves.

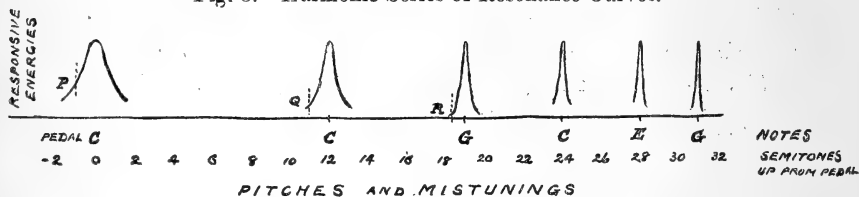

In laying out these graphs, we have again supposed that the damping coefficient k is constant throughout. The pitches of best resonance for the several tones are taken in the harmonic series as for a string or open parallel pipe. The corresponding ranges then follow inversely as those frequencies, the values of the sharpness being directly as the frequencies. Thus, the responses are in each case fullest at the precise frequencies natural to the supposed system, and fall off when the frequency of the forcing is too high or too low. But the degree of falling off for a given mistuning varies with the natural pitch of resonance, being small for the lower tones and larger for the higher ones. In other words, the range is extensive for the low tone, but the sharpness is striking for the high ones. Here again the values of the sharpness of resonance are, as in fig. 1,

10, 20, 30, 40, 50, and 60.

Range of Resonance nearly proportional to Decrement.—By equation (7) we see that the vibrations natural to the responding system are proportional to

where
$$\left. \begin{aligned} & e^{-kt/2} \sin qt \\ & \gamma = p \sqrt{1 - k^2/4p^2} \end{aligned} \right\} \dots \dots \dots (24)$$

Hence, if λ be written for the logarithmic decrement of the vibrations per *complete* period, we have

$$\lambda = \frac{\pi k}{q} = \frac{\pi G}{\sqrt{1 - G^2/4}} = \pi G' \text{ say. (25)}$$

Thus, when G^2 is small enough to make the quantity under the root sensibly equal to unity, we may use, instead of G , the approximate value G' defined by (25).

Or, in other words, when the range of resonance is small, it is almost proportional to the logarithmic decrement of the natural vibrations of the responding system. The distinction is shown by the following numerical values :—

True Range G	= 0.1,	0.2,	0.3,	0.4,	0.5	}	(26)
Approximate do. G'	= 0.1001,	0.201,	0.303,	0.408,	0.517		
Percentage Difference	= 0.1,	0.5,	1,	2,	3.4		

The possible variations of the essential factors in the range of resonance may be now conveniently summed up as follows :—

For p constant, $G \propto k$ (27)

For k constant, $G \propto 1/p$ (28)

For $k \propto p$, G remains constant . . . (29)

The first of these illustrates what appears to be the common idea, that the character of the resonance depends on the damping present in the responding system. The second shows under what condition the sharpness of resonance varies directly as the frequency. While the last is the special case in which the character of the resonance remains unchanged in spite of changes occurring proportionally in both damping and frequency coefficients.

Some vibrational systems may fall naturally (or even inevitably) into one or other of the above classes. Others may lend themselves to modifications at the experimenter's disposal which enable him to relegate them to one class or another at will. Examples in illustration of these cases occur later in the paper.

If, in any vibrational system, we are unable to modify k at will, but know how it varies, if at all, with p ; we can then predict the corresponding changes in G and H and may be able to put them to the test experimentally. Conversely, in a vibrational system for which we cannot easily obtain any direct experimental knowledge as to any variation of k ,

but can observe and measure G for various values of p ; then the variation of k may be inferred from the theoretical relation between it and G . In this case, an indirect determination would be made for k where a direct one was not available.

Helmholtz's Theory for the Ear.—In one of the appendices of his classic work, Helmholtz mathematically treated the case of forced vibrations, in order to throw light upon the damping of the responsive portions of the human ear. (See 'Die Lehre von der Tonempfindungen, &c.', Beilage IX. and pp. 213–217, Braunschweig, 1865; or Ellis's English translation, 'Sensations of Tone, &c.', Appendix X. and pp. 142–145, London, 1895.)

In the corresponding part of the text he gave in a table some numerical results of the theory over the range that he considered relevant to the case under discussion. But he formulated no quantitative definition of sharpness of resonance or of its range, neither did he point out that these quantities might vary with pitch. On the contrary his entire emphasis was placed on the damping. His method, however, when examined, is found to involve the dependence of sharpness of resonance on what he regarded as *approximately the logarithmic decrement*. And this quantity is really the quotient k/p found in this paper as the value of the true range G , see equations (25) and (26). Indeed, at a certain intermediate stage in an explanation of Helmholtz's treatment, given by the present writer ('Text-Book of Sound,' Equation (18), p. 148, London, 1908), an expression was used which is equivalent to equation (21) of this paper, the one being the inversion of the other. But the earlier equation was written purely as a paraphrase of Helmholtz without the faintest idea that it expressed anything more than the part played by the damping which was then receiving attention. Its full significance was not realized until it had been independently obtained in the manner here set forth, and the likeness between the two accidentally noticed.

In the numerical work referred to, Helmholtz took for each case that particular mistuning which involved a reduction of the kinetic energy of response to *one-tenth* of its maximum. He also gauged the logarithmic decrement of the responding system by the number (x say) of complete periods required for the energy of the natural vibrations to sink to *one-tenth* of its initial value. But the estimate of this number (x) was made on the approximate supposition that the period was unmodified by friction.

It is easy to see that the value of x thus obtained is proportional to the sharpness of resonance H as defined in equation (21). Thus, from equation (24), we see that the required decrement of energy is given by

$$\frac{1}{10} = e^{-kt},$$

where $t = x$ periods as if no friction were present, so that

$$t = 2\pi x/p.$$

Hence
$$e^{2\pi kx/p} = 10 = e^{2\pi x/H},$$

or
$$H = (2\pi \log_{10} e)x = 2.7299 x. \quad \dots (30)$$

It may be well to note here the values of range and sharpness in the present definitions for the numerical cases calculated by Helmholtz. These are shown in Table I.

TABLE I.

Range and Sharpness of Resonance for Helmholtz's Values.

Musical intervals of mistuning involving a reduction of the responsive energy to one-tenth.	Number (x) of complete periods in which the energy of the natural vibration sinks to one-tenth.	Sharpness of Resonance. $H = \frac{p}{k} = 2.7299 x.$	Range of Resonance. $G = \frac{1}{H} = \frac{k}{p}.$
Tones.			
1/8	38.00	103.8	0.00964
1/4	19.00	51.9	0.01928
1/2	9.50	25.9	0.0386
3/4	6.33	17.3	0.0579
1	4.75	13.0	0.077
1 1/4	3.80	10.4	0.0964
1 1/2	3.17	8.7	0.115
1 3/4	2.71	7.4	0.135
2	2.37	6.5	0.155

Bjerknes on Electric Resonance.—Some years ago V. Bjerknes published a number of papers, mathematical and experimental, on the resonance phenomena presented by high-frequency electrical oscillations*. In some of these

* Of these it must suffice to mention the following:—*Ann. d. Physik*, vol. xlv. pp. 74-91, pp. 92-101, 1891; vol. xlvii. pp. 69-76, 1892; *Bih. Till. K. Sv. Vet.-Akad. Handl.* vol. xix. pp. 3-16, 1893; pp. 3-22, 1894; vol. xx. no. 4, pp. 3-58, no. 5, pp. 3-44, 1895; *Öfversigt af K. Vetensk.-Akad. Förhandlingar*, pp. 381-386, 1894.

he showed that the logarithmic decrements involved might be deduced from the proportions of the resulting resonance curve. But it does not appear that he pointed out the possibility of any variation of the sharpness of resonance with frequency while the damping coefficient remained constant.

Indeed, it is quite possible that for the cases then under examination, no such simple relation held as that here deduced for the case of forcing of sustained amplitude. For, in the cases usually dealt with by Bjerknes, the forcing was due to the oscillations in a Hertzian oscillator and was strongly damped. The responsive system was usually a Hertzian resonator in which the damping was relatively small.

Zenneck on Sharpness of Resonance.—In his treatise on Wireless Telegraphy, &c.*, J. Zenneck plots a resonance curve, with certain specified coordinates, and takes as a measure of the sharpness of resonance the *curvature* of this resonance curve at its *summit*. It is then shown that this curvature is proportional to the inverse square of the logarithmic decrement.

He does not, however, appear to make any use of the result or to analyse the decrement into its factors.

Raman on Maintenance of Oscillations.—In dealing with vibrations maintained by a periodic variation of the spring †, C. V. Raman has the following pertinent remark:—

“If the frequency of the imposed variation of ‘spring’ were 60 per second, the oscillations of the system would be maintained (under suitable circumstances) if the frequency of its free oscillations were nearly equal to 30 or 60 or 90 or 120 or 150 and so on, the degree of approximation to equality necessary increasing as we proceed up the series. The frequency of the maintained oscillation would be exactly 30 or 60 or 90 and so on” ‡.

It is accordingly seen that the view insisted upon in the present paper for ordinary forced vibrations has its counterpart in the maintained oscillations treated by Raman. And further, that this feature, overlooked by most for the ordinary vibrations, has been recognized by the Calcutta physicist with respect to these special ones.

* *Elektromagnetische Schwingungen und Drahtlose Telegraphie*, Art. 312, p. 572, Stuttgart, 1905.

† “The Maintenance of Forced Oscillations of a New Type,” *Phil. Mag.* xxiv, pp. 513–520, Oct. 1912.

‡ *Ibid.* p. 517.

ILLUSTRATIVE EXPERIMENTS.

We may now notice several experiments in relation to the subject in hand. Some of these qualitatively illustrate the dependence of range of resonance on pitch as well as damping. Others yield a quantitative result in corroboration of the theory. While yet others are only fragments of a larger scheme which is just outlined and left for future examination.

The cases to be dealt with fall under three natural divisions:—mechanical, acoustical, and electrical. They will be noticed in this order.

The Double Pendulum.—As apparently, the simplest possible illustration of forced vibrations, one is apt to think first of the double pendulum, the individual pendulums being of equal periods and one suspended from the other. Thus, a slight motion of the upper bob supplies the periodic impressed force of suitable frequency and may be expected to elicit and maintain oscillations of large amplitude of the lower bob.

But the idea of simplicity in connexion with this double pendulum is a delusion which a little reflexion or experience may serve to dispel.

In the first place, the motions may readily occur in various vertical planes. However, with a little care in their initiation they may be confined to a single plane, which is preferable.

We may next notice that, if the bobs are of nearly equal masses, the starting of the lower one involves, by its reaction, the stoppage of the upper one. This undesirable effect of reaction is easily reduced to a negligible quantity by making the mass of the upper bob many times that of the lower one.

Still, if both bobs are of the same material and construction, their damping coefficients will probably be not greatly different. Hence, the simple equations for sustained forcing do not apply.

Further, if the lower bob is of solid metal, or even dense wood (lead, brass, iron, or boxwood), its damping coefficient will be small and the resonance in consequence probably inconveniently sharp. So much so that it is extremely tedious to *tune* the pendulums well enough to avoid *beats*. These beats always occur in the early stages of the action of a slightly mistuned periodic force on a system initially at rest. And these beats must last till the vibrations natural to the responsive system have been practically damped out.

Hence, when this damping is very small, the beats are correspondingly persistent.

The disturbance of persistent beats is reduced by making the lower bob of less dense material than the upper. Thus the upper bob may be of solid iron in order that its damping shall be negligible, and the lower bob of hollow celluloid to make its damping large and thus favour tuning and avoid such persistent beating.

There is yet another undesirable complication in the double pendulum which is not provided for in the simple equations. This arises from the fact that the period of a simple pendulum is dependent slightly on the amplitude, the value commonly assigned being a lower limit which is approached as the amplitude vanishes. Thus, if the force is almost exactly in tune with the small oscillations of a pendulum, this leads to larger amplitudes which require a somewhat slower forcing, and so their further increase is checked.

Accordingly, if the simple equations are to apply to and receive illustration from the double pendulum, its vibrations should be confined within those limits of amplitude which do not appreciably affect the period.

Observing all the above precautions with the individual pendulums, each about a metre long, the beats were still persistent, so that no steady forced vibration could be maintained. Thus, in changing the length of the lower pendulum by about a centimetre each time and observing more than a dozen such settings, the phenomena of beats always appeared and brought the amplitude to zero after from 10 to 12 periods of the pendulum.

The lower pendulum was then hung from a fixed point, set to various lengths, the successive amplitudes in each case observed, the logarithmic decrement and the damping coefficient calculated. The latter proved to be practically independent of period and of value expressed by $k=0.075$, for the bob of a thin spherical shell of celluloid 6 cm. diam. (It was a toy ball of the sort formerly used for parlour tennis or "ping pong.") Thus, since k was found constant, the range of resonance G might be expected to vary inversely as the frequency, *i. e.*, directly as the square root of the length of the pendulum. Hence, with longer pendulums, the resonance should be less sharp and it should be easier to attain a tuning sufficiently exact to banish the beats.

For example, with a four-fold length, which was then adopted, the period and range of resonance were each

doubled, and the permissible changes of length for a given effect on the resonance much more than doubled. It was also easy, with the longer pendulums, to keep all the vibrations small in *angular* amplitude (and so practically isochronous) though still of ample *linear* dimensions. Thus, this increased length of the pendulums vastly improved the conditions as regards facility in tuning.

The individual pendulums were then each of the order 4 metres in length, the upper bob was of solid iron, 6.3 cm. diam., suspended by a wire, the lower bob was of hollow celluloid, 6 cm. diam., suspended from the other by a fine plaited silk line and adjusted in length by a tightener (as adopted for tent ropes). With this arrangement a slight motion of the upper iron bob quickly produced a considerable motion in the lower celluloid bob, originally at rest, and maintained its motion without any sign of beats, although over seventy vibrations were counted. The lower pendulum was in turn lengthened and shortened by about 8 centimetres without any appreciable change in the character of the resonance, the same number of vibrations being counted as before without the appearance of beats.

The bobs then in use were those which previously failed to avoid beats when on the pendulums of 1 metre long. To make a further test, the celluloid shell, in use for the lower bob, was next replaced by one of solid box-wood, each pendulum still being about 4 metres long. But this gave beats numbering only about five vibrations in the cycle from start to zero amplitude. It thus became evident that the large damping coefficient ($k/2$) and the small frequency ($p/2\pi$) were both needed to give a range of resonance which was large enough to permit of ready tuning of sufficient accuracy to avoid beats.

The theory is accordingly corroborated, and furnishes the necessary clue to the conditions to be adopted for the double pendulum in order that it should give a good illustrative experiment of maintained forced vibrations. It may be remarked that it would be still better if the upper bob were of lead and of even greater size than the lower bob, instead of being (as in the above experiment) of iron and of about the same size as the lower one.

Melde's Experiment with Constant Tension.—This experiment lends itself most readily to a hasty qualitative illustration of the increase of range of resonance with period when the damping coefficient remains unchanged.

It was at first tried, as indicated above, with the tension

of the silk line constant at 200 gm. weight. Four forks were used of frequencies 128, 256, 384, and 512 per second, giving 1, 2, 3, and 4 segments respectively, the transverse mode of the experiment being in use. The normal length of the thread for best tuning was slightly under a metre, say 98.5 cm. The range of resonance was roughly estimated by the increase or decrease of length of line necessary to practically destroy the response, the fork being bowed with the same vigour all through. This was soon seen to be distinctly greater for the low frequencies than for the high ones. In this, the first laboratory test of the theory, no refinement was aimed at, but to avoid any false conclusion due to a biased expectation, the test was repeated by two scholarship students (Messrs. C. Hayes and A. Warren) who had no idea what to expect. Their results are entered for the second experiment in Table II. The intervals are given in Ellis's logarithmic cents, 1200 to the octave.

TABLE II.

Melde's Experiment with Tension of 200 gm. wt.

Frequencies of Forks		128	256	384	512
Number of Segments in Silk Line ...		1	2	3	4
First Set of Experiments by the writer.	Extreme Lengths (in cms.) of line for appreciable response.	110	104	102	101.5
		87	93	96	97
	Differences of Lengths ...	23	11	6	4.5
	Intervals of mistuning (in cents) above and below.	} 18	9	5	3.5
Second Set of Experiments by two unbiased observers.	Extreme Lengths (in cms.) of line for appreciable response.	121	113	110	106
		81	85	90	93
	Differences of Lengths ...	40	28	20	13
	Intervals of mistuning (in cents) above and below.	} 75	22	16	7

The table shows that the junior experimenters pushed the forcing to a greater extreme and so had larger mistunings throughout than ruled in the writer's experiment. At this stage no attempt was made to evaluate the diminution of response, but the intention was to keep it constant for any one set of experiments with the four forks. It is seen that the range of resonance appears to increase with period even more than theory predicts on the assumption of a constant value of the damping coefficient ($k/2$) for the various periods.

It may be noted that the mistuning in these experiments was effected by sharpening or flattening the natural frequency of the responding vibrator and not that of the impressed force. This plan was obviously much easier to carry out and may be accounted equally effective.

Melde's Experiment with Constant Number of Segments.—It seemed desirable next to test the responses of a length of silk thread to the same forks, keeping the number of segments constant and varying the tension to tune it to the various forks. For if, while the damping coefficient remains unaltered, the frequency is *by any means* changed in a given ratio, then the range of resonance may be expected theoretically to change in the inverse ratio. And this result should be quite unaffected by the particular means used to effect the change of frequency. Hence this different mode of changing the frequency afforded a crucial test of the theory.

With the forks and loads available, a vibration in three segments was found convenient and was adopted. This series of experiments was made rather more quantitative. Thus it was endeavoured to keep the bowing of the fork the same throughout and to adjust the lengths in use until the amplitude of the responding vibration was reduced to one-half its maximum value for best tuning. That corresponds to about a quarter value of the kinetic energy (or $D = \sqrt{3}$), and so admits of an estimate of the value of the sharpness of resonance H . The results are shown in Table III. (p. 130). It will be seen that they are nearly in accord with a *constant* value of $k = 58$. That would mean that the energy of the natural vibrations of the silk thread would fall to $1/58$ th of its value in $1/58$ th of a second, which seems quite probable. In this experiment the scholars C. Hayes and A. Warren assisted.

TABLE III.

Melde's Experiment with Three segments.

Frequencies of Forks	128	256	384	512
Loads on Silk Line (in gms.)...	22	89	200	355
Extreme Lengths of Line for Amplitudes half the Maxima, <i>i. e.</i> , $D = \sqrt{3}$	134.5 117	127.5 121	126 121	127 124
Differences of Lengths	17.5	6.5	5	3
Mistunings: $M = \frac{n}{p} - \frac{p}{n}$	0.139	0.052	0.040	0.034
Sharpness of Resonance: $H = D \div M = p \div k$.	} 12.4	33	43	51
Theoretical Values of H for $k = 58$	} 14	28	42	56

Helmholtz's Experiment.—The responses elicited from a stretched string by a tuning-fork are pointed out by Helmholtz, and this experiment may be fitly named after him*.

For the purpose of investigating the sharpness of the response to forks of different pitches, it is necessary to use a movable bridge under the *string* of the monochord. In the present case a fine steel wire (0.6 mm. diam.) was used as the musical string to respond to the forks which were in succession placed upright with the stem pressing the string on to the movable bridge. To show the response to an audience, riders of card are usually placed on the string. The vibration then leaves in position the riders placed at *nodes*, but kicks off those riders occurring at the intervening places or *antinodes*. But this method is not very suitable for delicate individual trials. Neither does listening seem the best. The method which, for delicacy and quickness, appeared most satisfactory is that of lightly touching the wire at an antinode with the tip of a finger. If the response

* See 'Tonempfindungen, &c.', pp. 78-79, Braunschweig, 1865; or 'Sensations of Tone, &c.', pp. 46-47, London, 1895.

is well pronounced the wire's vibrations will be felt and checked at each touch, and even though the touches may be repeated very quickly, a marked vibration is felt each time. If, however, owing to the considerable mistuning, the response is very feeble, the vibrations are scarcely detectable even after longer intervals are allowed for their elicitation. And when the mistuning is pushed still farther, no response whatever can be felt. This was the state of things for positions of the bridge just a few millimetres beyond those given in Table IV., which record the last perceptible effects.

TABLE IV.
Helmholtz's Experiment.

Frequencies of Forks	128	256	384	512
Number of Segments	1	2	3	4
Extreme Lengths (in cm.) of Steel Wire for responses just perceptible	72.3 68.0	72.0 68.5	71.7 69.5	71.5 69.4
Differences of Lengths.....	4.3	3.5	2.2	2.1
Intervals (in cents) of mistunings above and below.....	} 53	43	27	25.5
Mistunings: $M = \frac{n}{p} - \frac{p}{n}$	0.0611	0.0496	0.0311	0.0294

This experiment was one of the early ones carried out before the theory was fully developed, and is only roughly quantitative. It indicates that the range of resonance decreases with increase of frequency, and that all the ranges are less than the corresponding ones in the case of Melde's experiment. And these results are in accord with theory, for the k is clearly much smaller for the dense smooth steel wire than for the light fluffy silk line. It is not, however, easy to determine k for this wire; as if the wire is plucked and let go and the amplitude observed by a reading microscope, one is troubled by a rotation of the plane of transverse vibration. Thus, at first, the amplitude appears to decrease

rapidly, then it pauses or even increases for a little before decreasing a second time. From a few rough trials, it appeared that for the wire in question, with a vibrating segment 70 cm. long tuned to 128 per second, k might be of the order 2 or 3; for the same length vibrating in more segments k appeared to be still larger. We might accordingly have the sharpness of resonance in this experiment increasing slower than the frequency, and assuming values measured by some hundreds. They are not inserted in the table however, as this is but an estimate, and cannot yet be checked by the known values of the responses.

Adjustable Resonator and Forks.—A very simple qualitative illustration of the dependence of the sharpness of resonance on frequency is afforded by an adjustable water resonator. This may consist of an upright cylindrical glass tube part filled with coloured water in communication with a reservoir which may be slid up and down a standard. The illustration may then be carried out as follows.

First, find by a preliminary trial the position of the water-level which leaves in the tube an air column in best resonance with a given fork, of frequency 128 say. Second, set the reservoir a little too high (or too low) on the standard, and put on the standard a stop (the thumb and finger of the left hand, say) which will allow the reservoir to be quickly moved a determinate distance to a place equally too low (or too high). Then, when the fork is bowed and held over the resonance-tube by one operator, the other must quickly move the reservoir from one stop to the other. The effect of this is that the water-level soon passes (and always at the *same definite speed*) the position of best resonance. The sounds just before and after the best resonance are thus heard, and the suddenness of the changes in loudness may be noted. The experiment is then repeated with a higher fork capable of eliciting a response from the same column. Its frequency must be $(2m + 1)$ times that of the fundamental, where m is any integer; since the resonance system is the air in a stopped pipe. Thus a fork of 384 ($= 3 \times 128$) would serve for the present case, and was adopted.

The changes in loudness are easily heard to be more sudden in the case of the higher fork.

As this is not a case in which one can readily commit to paper a quantitative statement of what is heard, independent witnesses were invited to listen and to describe what was heard or to sketch a graph for it. In this way Mr. Walter B. Kilby, Research Scholar, Mr. A. H. Franks, Lecture Assistant, and Mr. W. M. Roskelly, Student, all confirmed

the writer's judgment that the resonance was distinctly sharper for the 384 fork than for the 128 fork. Indeed, a shift of the water-level of a centimetre or more for the lower fork seemed to correspond to a shift of 2.5 mm. for the higher fork.

Reviewing now the last four experiments, we deduce the important result that if either Melde's or Helmholtz's experiment, or that with the adjustable water-resonator, is used for a determination of the pitch of a fork, then, *ceteris paribus*, the work is susceptible of higher accuracy for high pitches than for low ones; since at the higher pitches the resonance is sharper.

Brass Instruments.—Let us now consider the behaviour of the air in the brass instruments used in orchestral and other bands. The phenomena in question form an important illustration of the theory here advanced. The air contained in such instruments vibrates in response to the appropriate impressed forces applied at the cupped mouthpiece by the player's lips and breath. Further, this column of air, like the thread in Melde's experiment, can give a series of tones according to the number of vibrating segments into which it is divided. Again, the vibrations of the air in these instruments may be expected to have a very large value of the damping coefficient ($k/2$), for the whole mass of this air is very small, yet the activity of its output is very great. Thus we may anticipate that such instruments will show very plainly a range of resonance and a difference in this range from note to note, as in Melde's experiment. And so they do, but they have also complications of their own which are not present in the vibrating thread.

These complications involve a disturbance of the pitch of the prime and arise as follows. As is well known, an *open* parallel pipe of given length and width has a certain fundamental tone and the *full* harmonic series of other tones. A *stopped pipe* of the same dimensions has a fundamental nearly an *octave lower* and only the *odd* series of harmonics. A pipe in the form of a complete cone with open base and *closed* vertex of the same length and base diameter as the foregoing, has a fundamental in agreement with the *open* parallel pipe, and has also the *full* harmonic series of other tones.

The brass instruments now under consideration may be regarded as derived from the cone by

- (i.) the opening of the vertex,
- (ii.) the introduction of a mouthpiece at that end, and
- (iii.) the provision of a bell at the other end.

But these changes somewhat vitiate the harmonic series of tones. To obviate this, as far as may be, the makers adopt a quasi-hyperbolic outline, and aim at so modelling the tube as to preserve in tune all the intervals in musical use. This usually leaves the lowest interval out of tune. But this is the interval (nominally an octave) between tone number two and the fundamental. This last is called the *pedal*, and is seldom employed musically. To set the upper notes of the series right the pedal of some instruments may be *lowered* in pitch, say in the ratio 6:5. There seem to be other instruments, of a different form of tubing, in which, for the same reason, the pedal is similarly raised, say, in the ratio 6:7. The two cases might then be represented by the following schemes of relative frequencies:—

5/6,	2,	3,	4,	5,	6,	&c.
7/6,	2,	3,	4,	5,	6,	&c.

In each of these schemes the first figure would have been unity, if not purposely disturbed to set the others in their right relation. Now, if the pedal of frequency represented by unity is ever required, it may be expected, on the theory of this paper, that the range of resonance at this low pitch would be great enough to allow the player to produce the note by forcing it to the desired pitch. But if the resonance can be spread in one direction (say down, from 7/6 to 1), it seems only natural to suppose that it could also be spread in the opposite direction (say up, from 7/6 to 4/3).

In this way it seems possible to account for the objective reality of a certain low note whose existence on the euphonion and bombardon is traditionally asserted among musicians.

Indeed, the present paper is the outcome of an endeavour to answer the question as to how this note arises (asked me by Mr. F. C. Edwards of Messrs. Besson & Co., Ltd.).

The note to which reference is made lies below note No. 2, but above the pedal (if of its true pitch unity). If the notes are represented in relative frequency by the natural numbers, as in the previous schemes, the low note in question would be represented by the fraction 4/3. Or, when the notes are represented by letters as though the instrument were in the key of C (which is the practice in writing music for valved instruments) then the note is called a low F. The actual pitch of the note varies with that of the instrument. This is illustrated in the following schemes of notes which can be sounded on these instruments as *open* notes, *i. e.* without using the valves.

The anomalous note is inclosed in brackets, and the pedal

is shown as if of the true nominal pitch to form the base of the harmonic series.

Relative frequencies :—	1	(4/3)	2	3	4	5	6	&c.
Notes as written for all valved instruments ... }	C	(F)	C	G	C	E	G	&c.
Actual notes for B♭ instruments	B♭	(E♭)	B♭	F	B♭	D	F	&c.
Actual notes for E♭ instruments	E♭	(A♭)	E♭	B♭	E♭	G	B♭	&c.

This special note may have been discovered because of its usefulness. For the three-valve mechanism is designed to supply the chromatic scale in the interval between notes 3 and 2, which are seen to be a musical fifth apart. This mechanism accordingly more than bridges all the smaller gaps, occurring among the higher open notes, but fails to bridge the larger gap of an octave occurring between notes 2 and 1. But, if the note of frequency 4/3 can be obtained without the valves, then the valves can give the chromatic intervals in the gap between notes 2 and 4/3, and in that between the notes 4/3 and 1. Thus the chromatic scale is obtainable throughout what is called the *pedal octave*.

Now, though it might be very difficult to account for a full but *isolated* resonance of the pitch referred to (4/3 or low F), it is yet easy to see that the resonance at this pitch may not be isolated at all, but may actually spread *continuously* down from the pitch in question to the pedal of true pitch; and yet this fact escape notice among musicians. For they, having got this one note without valves, might then use them to extend the scale.

The view here put forward is that, on the instruments which show best this low F, the true pitch of best resonance of the pedal usually lies between this F and the C below, and that, by appropriate forcing, the notes F and C can each be sounded, but also *every other note between*, and probably some of these easier than the extremes of pitch to which the resonance can be pushed. And this is indicated in the above schemes by the dots linking up the nominal pitch of the pedal with the anomalous note. The low F may occur on some instruments of a different form of tubing by a downward spread of continuous resonance from note No. 2.

The convictions just stated were arrived at by an alteration of theory and experiment which need not be detailed here.

In October last Mr. D. J. Blaikley (Messrs. Boosey & Co., Ltd.) was good enough to sound notes on five instruments in the writer's hearing, the pitches being settled by a harmonium. Mr. E. C. Pickerill (Trumpeter in the Hallé Orchestra) also tried effects on the cornet, and kindly communicated the results. In addition, as a corroboration and for the sake of actual experience of the *feel* of the various notes, all the six types of instruments were personally tested by the writer, the pitches being determined by harmonium or piano, a witness being also at hand to attest the correctness of the effects recorded.

The combined results are given in Table V., the term *open* referring to the fact that no valves were in use nor any slide drawn out to produce the notes in question. The figures in brackets give the frequencies.

It will be seen that the resonance is considerably spread on the lower notes of all these instruments.

In the case of the trumpet, cornet, French horn, and trombone, the spreading is almost entirely below the nominal pitches, and all these instruments have much narrow tubing which is almost parallel. In the case of the trombone, the anomalous note under discussion was just reached by Mr. Blaikley as a spreading *downwards* of the continuous resonance from note 2! A different make of trombone, under the writer's inferior skill, failed at a whole tone above this pitch.

We consider next the euphonion and bombardon, instruments characterized by large conical tubing. The two euphonions tried gave almost identical results, the anomalous note being in each case easily obtained as an upward spreading of the continuous resonance of the pedal, which was obviously sharper than the nominal pitch (corresponding to 1 or C). The writer's experience of these lower notes of the euphonion was that the middle four (B, C, C#, D) came fairly bright and full, the extreme pitches reached (A and E) were poor notes. It was distinctly felt that the best resonance was in the middle, tailing off at the ends, the whole being a single spread resonance of considerable range.

With the low notes of the bombardon in Eb, considerable difficulty may be experienced in forcing the notes out of tune, for the internal volume of the instrument is nearly three times that of the euphonion; hence the mass of air to be set in vibration is correspondingly increased and is felt to be somewhat unmanageable. But, after a few trials, both the writer and a colleague, Mr. Ambrose Wilkinson, B.Sc., obtained spread resonances for the pedal and for note 2, as shown in the table.

TABLE V.—Spread Resonance of Lower Open Notes on Brass Instruments.

Instrument and Key.	Maker.	Player.	Pedal.	(Low "P")	No. 2.	No. 3.
Trumpet in B ♯.	Boosey.	D. J. Blankley	F F ♯ G A ♯ A B ♯ (120)	----- F F ♯ G A ♯ A	B ♯ (240)	B
	Brown.	E. H. Barton	E F F ♯ G A ♯ A B ♯	----- A ♯ A	B ♯ (240)	B
Cornet in B ♯.	Boosey.	E. C. Pickering	F --- G A ♯ - B ♯ (120)	----- F --- G A ♯ -	B ♯ (240)	
	Boosey.	E. H. Barton	E ♯ E F F ♯ G A ♯ A B ♯	----- G A ♯ A	B ♯ (240)	
Trombone in B ♯.	Boosey.	D. J. Blankley	F ♯ G A ♯ A B ♯ (90)	----- (E ♯) E F F ♯ G A ♯ A	B ♯ (120)	B
	Millereau.	E. H. Barton	G A ♯ A B ♯	----- F ♯ G A ♯ A	B ♯ (120)	B
French Horn in F.	Boosey.	D. J. Blankley		C D ♯ D E ♯ E	F (90)	F ♯ --- A B ♯ B (135)
	Boosey.	E. H. Barton		E ♯ E	F (90)	F ♯ --- B ♯ B (135)
Euphonium in B ♯.	Boosey.	D. J. Blankley	B ♯ (60)	B C C ♯ D (E ♯) --- A ♯ A	B ♯ (120)	B
	Besson.	E. H. Barton	B ♯ (60)	B C C ♯ D (E ♯) E --- A	B ♯ (120)	B
Bombardon in E ♯.	Boosey.	D. J. Blankley	E ♯ (40)	(A ♯) --- C D ♯ D	E ♯	
	Besson.	E. H. Barton	E ♯ (40)	E F F ♯ G (A ♯) A --- C ♯ D	E ♯ (80)	E
	do.	A. Wilkinson	E ♯ (40)	E F F ♯ G (A ♯) --- C C ♯ D	E ♯ (80)	E
	Boosey.	D. J. Blankley (March 1913)	E ♯ full	E F F ♯ G (A ♯) --- C ♯ D fair poor fair full	E ♯ full	E ♯ fair poor

On the other hand, Mr. Blaikley last October, after a similar spreading of note 2, tried for lower notes, obtained the low "F" (actual pitch A♭), but did not then persist further, this being the last instrument tested of the whole series of five in one afternoon. Also in a test by Mr. F. C. Edwards, the instruments being blown by Mr. H. Perry (both of Messrs. Besson), the only note obtained between the pedal and its octave was the low "F" (really A♭). But on the euphonium Mr. Perry only sounded the pedal C, the E and F above it, and spread the note 2 from C so as to include B and B♭. (Actual pitches of the notes: E♭, G, A♭, E♭, D, and D♭.)

Indeed, it appears that a highly trained professional player is sometimes unable to outrage the traditions of his school sufficiently to obtain, by forcing, these strange notes, which do not constitute any ordinary musical acquisition.

Further, Mr. Blaikley has put forward a theory that the low "F" may be favoured by the upper resonances of the instrument, since the third partial of this note is identical with the fourth tone or open note of the instrument. This is indicated in the following scheme:—

	Pedal.					
Relative frequencies of Open Notes	1	2	3	4	5	6
Names as written for Valved Instruments..	C	C	G	C	E	G
Anomalous Note	F					
Its upper partials, and	-----	f	-----	c		
Their frequencies.	4/3	8/3		4		

This view has doubtless a foundation in fact, and would account for this low "F" appearing isolated, *provided* this upper resonance *were strong enough*. Probably this depends on the style of blowing. But, in the writer's experience, the effect in question, if present, was too feeble for recognition, although looked for.

Sometimes the spread resonance seems asymmetrical, especially for the note 2, the best note being near one end of the continuous resonance at different pitches. But no case was experienced of some part of the spread resonance of the pedal being particularly favoured as though there were a pimple on the general resonance curve.

Since writing the above Mr. Blaikley has kindly made further tests (March, 1913), those for the bombardon being inserted in the last line of Table V. This test, made when

fresh, obtains the continuous resonance for the pedal anticipated by me and thus confirms the theory here put forward. It also, however, supports Mr. Blaikley's own view as to the upper partial resonance. For he felt the low "F" and pedal "C" to be better notes than those between. In other words, in his experience, the resonance was spread *continuously* over a considerable range of pitch but had pimples on the curve at two special pitches whose upper partials *agree* with some of the *natural tones* of the instrument.

In reporting the above test Mr. Blaikley also expressed his agreement with my view as to the pitch of the pedal being sharp on some instruments and flat on others. He writes: "It is pretty evident that on the large conical instruments the range of forced notes is greater upwards than downwards, and that the reverse holds good on instruments of the trombone type, and I quite agree with you as to the cause of this."

It may be noticed that in Table V. only two low ranges of resonance are usually dealt with for each instrument. The higher notes did not, as a rule, permit of flattening or sharpening to an extent measurable by semitones, hence their omission from the scheme. But, to test this smaller range of the higher notes in a somewhat closer way, a B♭ cornet was tuned about a quarter of a tone sharper than the piano used for comparison. The various open notes of the instrument were then blown with an endeavour to flatten or sharpen their pitches so as to elicit a resonance from the corresponding piano strings, whose digitals were *quietly put down and held*. In this manner, from the pedal note of the cornet four strings of the piano were set in vibration, viz., A♭, A, B♭, and B. Thus the note could be flattened and sharpened by about *three-fourths* of a tone from its pitch of best resonance, say, between A and B♭, to the extremes of A♭ and B. With note No. 3 on the cornet only two strings could be made to vibrate audibly, viz., F and F♯. Thus this note could only be flattened and sharpened about *one-fourth* of a tone. But the note in question has nominally three times the frequency of the pedal. It might accordingly be theoretically expected to have only one-third the range of resonance, as appears to be the case.

As to the absolute values of the range and sharpness of resonance for these instruments, more exact data are needed for their determination than are at present to hand. It must suffice now to make a rough estimate in the case of one instrument, the cornet in B♭.

The theoretical values are the quotients of k and p , which

measure the damping and frequency; the latter is known, but to the former we can only approximate. Thus, staccato notes of about 5 or 6 per second may be sounded on the cornet, or a shake of 10 or 12 notes per second in all. It would thus appear that the decay of the vibrations expressed by e^{-kt} would reduce the energy to one-tenth in something like $1/14$ of a second, if not in less. This gives as an inferior limit for k the value 10π say. A similarly rough estimate of the diminution of response when the pedal note is blown out of tune a minor third ($n/p=6/5$, $M=1/3$ nearly, $N_0/N=6$ say) makes k of the order 30π . Thus, taking the mean, we may regard k as being of the order 20π . This gives for the sharpness of resonance values of the following order:—

Notes of Cornet	Pedal, 2, 3, 4, 5, 6, &c.
Sharpness of Resonance ...	10, 20, 30, 40, 50, 60, &c.

As these are only approximate, no attempt has been made to allow for (i.) a possible variation of k with pitch, or (ii.) a departure of the pitch of the pedal from the relative frequency denoted by unity. The above values for the sharpness of resonance were adopted in drawing the resonance curves in figs. 1 and 3.

Referring now to either of these figures, we see that (on a small and manageable instrument) the pitch of a low note in this harmonic series could easily be forced considerably out of tune, since the range of resonance is there considerable. But if this is done, the diagrams also show that there would be very slight response on the part of the higher tones which are needed as the upper partials of the lower. Thus, the forcing out of tune by a semitone of the pedal note on the cornet (about 120 per second) would involve only a very moderate diminution of response of the tone of this pitch. But this mistuning would involve relatively large reductions in the responses of the higher possible tones which are needed as its upper partials. This is seen by the single ordinate PQR on fig. 1 and the corresponding three related ordinates P, Q, and R on fig. 3. These ordinates are all a semitone out of tune with the pitch of the instrument. This progressive falling off in response of the notes as we proceed up the series renders the quality of this mistuned note very dull and poor, if produced by a novice. Probably an expert can blow a note slightly out of tune and yet so favour the upper partials by his special skill as to produce a tone of good musical quality in spite of the inherent difficulty.

This leads to another point concerning brass instruments which is elucidated by the present theory. In the ordinary

three-valved brass instruments of any pitch, the second valve alone adds sufficient tubing to lower the pitch a semitone, and the first valve alone adds sufficient to lower it a whole tone. The two used together accordingly lower the pitch approximately a tone and a half. The third valve is usually employed only in conjunction with one or both of the others. It is often tuned so that with the second valve the pitch is lowered two tones. If now a total lowering of three tones is desired, it is obvious that the simultaneous use of the first valve is unable to effect this. For, with the second and third valves already down, the tubing is a quarter longer than originally, hence the first valve needs to be itself a quarter longer than originally in order to be able to depress by a whole tone the pitch which is already depressed by two tones. It may thus easily happen that the note with all three valves down (immediately above note No. 2, written as C♯) is about a quarter of a tone sharp, and needs "coaxing" by the lips and breath of the player to be blown in tune.

But the three valves are not needed for any higher note than this C♯ (between the notes Nos. 2 and 3, which are a musical fifth apart). And at this low pitch the considerable range of resonance available makes the requisite coaxing comparatively easy on a small instrument like the trumpet or cornet. An octave higher, where the same mistuning would be difficult or impossible to achieve by coaxing, it is not needed. For there the first and second valves suffice to give the chromatic scale in the gap of two tones between notes Nos. 4 and 5.

On large instruments like the euphonion and bombardon, this coaxing or forcing is not so easy. It is accordingly desirable in them to use the special compensated valves which give a very close approximation to the lengths of tubing theoretically required for the notes to be produced by any combination of the valves. But the present theory shows why these compensated valves have acquired so little vogue on the smaller instruments. For the faulty intonation due to the combination of ordinary valves occurs only in the lower part of the compass, and there the proportionately greater range of resonance enables the player to force into tune the comparatively small mass of air contained in the instrument.

Possible Electrical Examples.—In the case of forced electrical vibrations, which might be supposed to be the most complicated of all, it is easy to see that many of the factors of the case are entirely at our own disposal. Thus, by modifying the values of the inductance, resistance, and

capacity of the responding circuit, we can control both its frequency and its sharpness of resonance to suitable forcing oscillations provided they are of *sustained* amplitude. Moreover, this can be done in a variety of ways so as to fulfil some other condition, such as keeping the inductance of a given value, halving the resistance or quadrupling the capacity. A few of the alternative ways of doubling the sharpness of response under sustained forcing are shown in Table VI.

TABLE VI.
Sharpness of Electric Response under Sustained Forcing.

Electrical Quantities.			Coefficients for		Sharpness of Response. $H = p/k$ $= \sqrt{L} \div R \sqrt{C}$.
Inductance L.	Resistance R.	Capacity C.	Damping. $k = R/L$.	Frequency. $p = 1 \div \sqrt{CL}$.	
4 L	R	C	$k/4$	$p/2$	The Sharpness of Response for each of these new circuits is 2 H, or double that for the original one.
L	R/2	C	$k/2$	p	
L	R	C/4	k	$2p$	
L	R/4	4 C	$k/4$	$p/2$	
2 L	R	C/2	$k/2$	p	
L/4	R/4	C	k	$2p$	

It was hoped that some electrical experiments in confirmation of this table could be made on Dr. Fleming's cymometer and included in the present paper. But a little reflexion sufficed to show that the ordinary conditions of using the cymometer are too complicated for the suppositions of equation (11) and must be referred to the more general form (10).

For the forcing circuit usually has a spark-gap, and its oscillations are accordingly strongly damped. Thus h , as well as k , needs to be taken into account. And, although both k and h may be small compared with n and p , yet they cannot be small compared with $(p^2 - n^2)$ when this difference is itself on the point of vanishing. And this is precisely the state of things in which we are most interested, because it is then that the tuning is close and the response full. In other words, we are then near the peak of the resonance curve.

A preliminary trial with the cymometer was, however, made by Mr. W. B. Kilby, B.Sc., with the values of L and R remaining unchanged but with the capacities of values C

and C/4 respectively, thus giving frequencies as one to two (each being millions per second). But no appreciable change in the sharpness of resonance was observable by the method then in use, viz., the neon tube.

It is thus evident, both on theoretical and experimental grounds, that a more extended examination is needed for the investigation of electrical forced vibrations and their responses under various conditions. This is accordingly reserved for another occasion.

SUMMARY.

We may now briefly summarize as follows:—

1. In the case of vibrations executed under sustained harmonic forcing, it has been shown theoretically and experimentally that the sharpness of response (as here quantitatively defined, see equations (19) to (21)) varies directly as the frequency of the vibrations it is sought to elicit, provided the damping coefficient remains constant.

2. These relations are held to apply to any forced vibrations fulfilling the above conditions, whether mechanical, acoustical, or electrical.

3. This principle affords a valuable clue to the best arrangement of certain experiments on forced vibrations whether of a merely qualitative nature to illustrate lectures, or of a strictly quantitative character for laboratory determinations.

4. In the case of brass instruments the variation of the range of resonance with pitch is specially noticeable. It serves to elucidate the apparently anomalous production on certain instruments of a low note (written as "F") by its inclusion in the upward spread resonance of the fundamental (called the pedal and written as C). The range of resonance at this low pitch really embraces these two notes (a major fourth apart) and everything that lies between them.

Various other points in the theory and practice of brass instruments are also rendered clearer by the theory here advanced.

5. The strongly-damped electrical oscillations usually dealt with on Dr. Fleming's cymometer lie outside the scope of the simple theory here developed for the responses under sustained forcing. The simple theory may, however, be expected to apply to any cases where the forcing is due (i.) to commercial alternations of sine form, or (ii.) to the sustained electric waves of the Poulsen or other such system of wireless telegraphy.

University College, Nottingham,
March 22, 1913.

V. *Fermat's Law.* By Prof. D. N. MALLIK,
B.A., Sc.D., F.R.S.E.*

1. FERMAT'S law of swiftest propagation of light is $\delta \int dt = 0$, where t is the time of propagation and δ is the operator of the calculus of variation. Now, since on the wave-theory μ the index of refraction varies inversely as the velocity of propagation, the above is obviously the same as $\delta \int \mu ds = 0$, an equation which, as is well known, analytically embodies a complete kinematical statement of all optical phenomena.

2. Thus,

$$\begin{aligned} \delta \int \mu ds &= \int \delta \mu ds + \int \mu d\delta s \\ &= \int \left(\frac{\partial \mu}{\partial x} \delta x + \frac{\partial \mu}{\partial y} \delta y + \frac{\partial \mu}{\partial z} \delta z \right) ds + \int \mu \left(\frac{dx}{ds} d\delta x + + \right), \end{aligned}$$

since $ds^2 = dx^2 + dy^2 + dz^2$,

and therefore $d\delta s = \left(\frac{dx}{ds} d\delta x + + \right)$.

Therefore, integrating by parts, we have obviously,

$$\int \left[\frac{\partial \mu}{\partial x} - \frac{d}{ds} \left(\mu \frac{dx}{ds} \right) \right] \delta x ds + + = 0,$$

or $\frac{\partial \mu}{\partial x} = \frac{d}{ds} \left(\mu \frac{dx}{ds} \right)$, &c.,

while, at a bounding surface, $\mu \frac{dx}{ds}$, &c., are continuous, giving the laws of reflexion and refraction and the path of a ray in a heterogeneous singly-refracting medium.

3. Again, let PQ, QR be the incident and refracted rays at a surface of separation between the media of refractive indices μ, μ' , and let P'R' be a ray parallel to PQ, and P_qR a ray consecutive to PQR.

* Communicated by the Author. An abstract of this paper was read at the Annual General Meeting of the Indian Association for the Cultivation of Science, Calcutta, held on Thursday, the 28th November, 1912. First published as a Bulletin of that Association.

Then, drawing $QQ'Q''$ perpendicular to PQ and qq' , RR' perpendicular to QR , we have

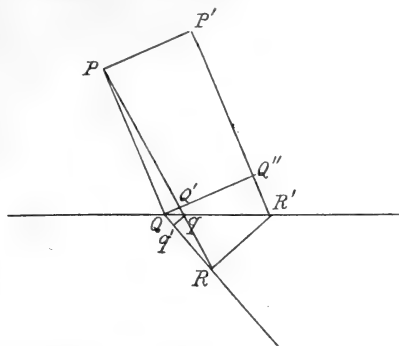

since $\mu PQ + \mu' QR = \mu' Pq + \mu' qR,$
 $\mu Q'q = \mu' Qq',$
 or $\mu Q''R' = \mu' QR.$

This gives Huygens's construction for singly refracting media.

4. If the second medium is doubly refracting, QQ', RR' are the traces of the wave-fronts (in the plane of the paper) and thus, since the wave-surface is the envelope of the wave-front, the wave-surface can be determined, in the usual way, as the envelope of

$$(lx + my + nz) = v,$$

where l, m, n are the direction-cosines of the normal to the wave-front and v the velocity of propagation, while $l, m, n,$ and v must be connected by a relation which, however, requires to be determined on some theory, independent of Fermat's principle (such as Fresnel's). Thus, Fermat's principle is seen to be capable of giving a complete kinematical account of double refraction, also—with a subsidiary hypothesis, regarding the law of variation of μ with direction.

5. Again, since $\delta \int \mu ds = 0,$ we may take $\mu ds = dV,$ and we have $\delta V = 0$ at a reflexion or refraction.

And, since

$$\frac{\partial V}{\partial s} = \mu, \quad \text{or} \quad \frac{\partial V}{\partial x} : \frac{\partial V}{\partial y} : \frac{\partial V}{\partial z} :: \alpha : \beta : \gamma,$$

where α, β, γ are the direction-cosines of the ray, we conclude that $V = \text{constant}$ is a surface orthogonal to a system of rays.

Accordingly, if a given surface can, at any stage, be made to coincide with a surface $V = \text{constant}$, a surface can always be drawn to coincide with any other member of the family $V = \text{constant}$: or

Any system of rays originally orthogonal to a surface will always be orthogonal to a surface, after any number of reflexions and refractions.

6. Since, then, the rays of light (which are orthogonal to a surface) may be regarded as normals to a family of surfaces, and by Sturm's theorem all the normals to a surface in the neighbourhood of a point converge to or diverge from two focal lines at right angles to one another, each of which passes through the centre of curvature of one of the principal normal sections and is perpendicular to the plane of that section, we conclude that all the rays of a thin pencil which can be cut at right angles by a surface pass through two lines, such that the planes containing either of them and the principal ray are perpendicular to each other.

7. Again, since the equation of a surface near the origin with the axis of z along the normal at the origin is, to the second order,

$$2z = \frac{x^2}{\rho_1} + \frac{y^2}{\rho_2},$$

the characteristic function ($V = \text{constant}$) for a thin pencil in a medium μ with the axial ray proceeding along the axis of z is

$$V = \mu \left(2z - \frac{x^2}{\rho_1} - \frac{y^2}{\rho_2} \right),$$

approximately, if the aberration is neglected. With the help of this equation, the problem of reflexion and refraction of direct and oblique pencils (aberration being neglected) can be treated in the usual way.

8. To illustrate this, consider the following example:—

A pencil of rays is refracted through a prism and the axis of the pencil is constantly in a principal plane of the prism: also the angular position of the focal lines at incidence and after the first and second refraction relative to the edge of the prism is defined by α, β, γ , and the distances of the initial and final foci from the first and the second surface are u_1, u_2 and v_1, v_2 respectively.

Let us also take U_1, U_2 as the distances of the foci after the first refraction, from the first surface, and V_1, V_2 these distances from the second surface.

Then $V_1 - U_1 = V_2 - U_2 =$ length of the axial ray in the prism.

Let, finally, ϕ, ϕ' be the angles of incidence and refraction at the first surface, and

ψ, ψ' be the angles of incidence and refraction at the second surface.

The edge of the prism being taken as the axis of y and the normal to the face of incidence as the axis of z , the direction-cosines of one of the focal lines before incidence are :

$$\sin \alpha \cos \phi, \quad \cos \alpha, \quad \sin \alpha \sin \phi.$$

Thus, the characteristic function before incidence becomes

$$V = \mu \left\{ x \sin \phi + z \cos \phi - \frac{1}{2u_1} (x \sin \alpha \cos \phi + y \cos \alpha + z \sin \alpha \sin \phi)^2 \right. \\ \left. - \frac{1}{2u_2} (x \cos \alpha \cos \phi - y \sin \alpha + z \cos \alpha \sin \phi)^2 \right\}.$$

From the continuity of the function, at $z=0$, we get by equating coefficients of x, x^2, xy, y^2 ,

$$\mu \sin \phi = \mu' \sin \phi'$$

$$\mu \left(\frac{\sin^2 \alpha}{u_1} + \frac{\cos^2 \alpha}{u_2} \right) \cos^2 \phi = \mu' \left(\frac{\sin^2 \beta}{U_1} + \frac{\cos^2 \beta}{U_2} \right),$$

$$\mu \left(\frac{\cos^2 \alpha}{u_1} + \frac{\sin^2 \alpha}{u_2} \right) = \mu' \left(\frac{\cos^2 \beta}{U_1} + \frac{\sin^2 \beta}{U_2} \right),$$

$$\mu \sin \alpha \cos \alpha \left(\frac{1}{u_1} - \frac{1}{u_2} \right) \cos \phi = \mu' \sin \beta \cos \beta \left(\frac{1}{U_1} - \frac{1}{U_2} \right) \cos \phi',$$

and similar equations for the second refraction.

9. In order to take account of aberration, we must obtain the characteristic function up to the order zx^2 .

Let the equation of the characteristic surface be

$$2z = \frac{x^2}{\rho_1} + \frac{y^2}{\rho_2} + 2z(\alpha x^2 + \beta xy + \gamma y^2) + \&c.$$

Now the perpendicular from the origin on the tangent plane

at x', y', z' , to the surface $2z = \frac{x^2}{\rho_1} + \frac{y^2}{\rho_2}$ is

$$\frac{z'}{\sqrt{1 + \frac{x'^2}{\rho_1^2} + \frac{y'^2}{\rho_2^2}}} = z' \left(1 - \frac{1}{2} \frac{x'^2}{\rho_1^2} - \frac{1}{2} \frac{y'^2}{\rho_2^2} \right),$$

if terms of the order zx^2 are retained.

Therefore, in

$$2z = \frac{x^2}{\rho_1} + \frac{y^2}{\rho_2},$$

we must write

$$z \left(1 - \frac{1}{2} \frac{x^2}{\rho_1^2} - \frac{1}{2} \frac{y^2}{\rho_2^2} \right),$$

instead of z , in order to be correct up to this order.

Hence the equation of the characteristic surface ($V = \text{constant}$) is of the form

$$V + z = \frac{1}{2} \frac{x^2}{\rho_1} + \frac{1}{2} \frac{y^2}{\rho_2} + z \left(\frac{1}{2} \frac{x^2}{\rho_1^2} + \frac{1}{2} \frac{y^2}{\rho_2^2} \right) \\ + ax^3 + 3bx^2y + 3cxy^2 + dy^3 \text{ (say),}$$

the terms in z^2 and z^3 being neglected, as being of higher orders.

The projection of this, on the principal plane $y=0$ is

$$z = \frac{1}{2} \frac{x^2}{\rho_1} + \frac{1}{2} z \frac{x^2}{\rho_1^2} + ax^3.$$

The equation of the normal to this, at x' , z' , is

$$\frac{x - x'}{\frac{x'}{\rho_1} + z \frac{x'}{\rho_1^2} + 3ax'^2} = \frac{z - z'}{\frac{1}{2} \frac{x'^2}{\rho_1^2} - 1}.$$

This meets the normal through the origin at the point $z, 0$, where

$$z = z' - \frac{\frac{1}{2} \frac{x'^2}{\rho_1^2} - 1}{\frac{1}{\rho_1} + \frac{z'}{\rho_1^2} + 3ax'}.$$

Therefore, the aberration in the principal plane is given by

$$z - \rho_1 = z' - \frac{\frac{1}{2} \frac{x'^2}{\rho_1^2} - 1}{\frac{1}{\rho_1} + \frac{z'}{\rho_1^2} + 3ax'} - \rho_1 \\ = z' - \frac{\left[\frac{1}{2} \frac{x'^2}{\rho_1^2} + \frac{z'}{\rho_1} + 3ax\rho_1 \right]}{\frac{1}{\rho_1} + \frac{z'}{\rho_1^2} + 3ax'} \\ = -3ax'\rho_1, \text{ rejecting terms of higher} \\ = -3a\rho_1^2\theta_1, \text{ where } \frac{x'}{\rho_1} = \theta_1. \quad \text{[orders,]}$$

We conclude, therefore, that all the kinematical results of optics can be deduced from Fermat's law.

10. Proceeding, now, to the dynamical significance of Fermat's law (which Fermat deduced from metaphysical considerations), we observe that the configuration of equilibrium and motion of a dynamical system is defined by $\delta \int (T - V) dt = 0$, where

$$\begin{aligned} T &= \text{Kinetic energy,} \\ V &= \text{Potential energy.} \end{aligned}$$

If this is to be consistent with Fermat's law we must have, for light propagation,

$$T - V = C \text{ (constant). (1)}$$

Also, if $V' =$ Potential energy of light disturbance during the displacement of the disturbance through the length of a wave,

$$\int T dt = \int V' dt. (2)$$

From (1) and (2) we get

$$V + C = V',$$

showing that we must postulate a certain *intrinsic energy* in the system, whose motion is concerned with the propagation, in order to justify the principle of swiftest propagation.

11. Now, all the optical theories which have been at all successful in giving a fairly satisfactory account of the mechanism of light propagation depend on the assumption that the potential energy of light disturbance in a homogeneous medium is of the form

$$\iiint (w_x^2 + w_y^2 + w_z^2) dx dy dz.$$

Thus, on McCullagh's theory, w_x, w_y, w_z are the molecular rotations of the elastic medium, behaving as an elastic solid.

On the labile æther theory also, the energy function is found to assume the same form, together with certain surface integrals which vanish on account of the "labileness" of the medium at the boundaries.

And, finally, on the electromagnetic theory, w_x, w_y, w_z are the electric displacements of Maxwell.

12. It will be seen, however, that if the above expression is to be true of each element of volume, the equilibrium condition (as was pointed out by Stokes) is not satisfied, for it makes $x_y = -y_x$, where x_y, y_x are the tangential stresses on the opposite faces of an elementary parallelepiped. Now

this difficulty can be met, if we suppose that the above energy is not localized in each element of volume. But, in that case, we must postulate the existence of certain terms in the energy function for each such element which disappear when integrated throughout the whole volume of the medium. We must, that is, admit the existence of a certain amount of intrinsic energy in the medium which takes part in the propagation of light. This is virtually the view adopted by Larmor, who has pointed out that if we could postulate some concealed (rotational) phenomenon going on in each element, the kinetic reaction of which can give rise to the requisite couple, the instability pointed out by Stokes may be provided for. He goes on to remark that the explanation of gravitation is still outstanding, and necessitates some structure or property, quite different from or probably more fundamental than simple rotational elasticity of the æther and simple molar elasticity of material aggregations in it, and this property may be operative in the manner here required.

13. No doubt, the "labile æther" theory does not require this saving hypothesis, as it only postulates a certain form of energy function for a whole volume, not localized in each element (together with certain surface integrals, which must be supposed to vanish). At the same time, although, on this mode of regarding the question, the analytical difficulty is met, the hypothesis of "labile" æther leaves the peculiar property of the medium somewhat hazy and ill-defined, while, on the other hand, if the existence of intrinsic energy were admitted, we should have a clearer view of the intimate processes, whose resultant alone is exhibited by the final analytical result postulated.

14. Finally, as regards the energy function on the electromagnetic theory, the formal similarity of the expression for potential energy of the rotationally isotropic medium of McCullagh and the electrostatic energy enables us to interpret the intimate nature of the electric field in the same way, that is, on the basis of the same postulate of a certain amount of intrinsic energy of the æthereal medium.

15. This same postulate, moreover, serves also to explain, in a fairly simple manner, the specific (Faraday-Maxwell) property of the electrostatic field. For, since the energy of such a field is $\int \frac{k}{8\pi} F^2 d\Gamma$, we may suppose it to arise from the stresses given by Maxwell, viz. a tension $\frac{kF^2}{8\pi}$ and an equal pressure $-\frac{kF^2}{8\pi}$. Now, assuming that the system of

electrostatic stresses is actually that given by Maxwell, and that the energy due to it is *localized* in the elements of volume of the dielectric, we have, in an element of volume $d\Gamma$, energy W , where

$$W = \frac{kF^2}{8\pi} d\Gamma,$$

and therefore

$$dW = \frac{kF dF}{4\pi} d\Gamma.$$

But this energy must be equal to the work done by the stresses given above.

To find an expression for this, let α, β, γ be the sides of the volume $d\Gamma$, so that $\alpha\beta\gamma = d\Gamma$. Then the increments of α, β, γ due to the electrostatic stresses will be, say, $\alpha d\epsilon_1, \beta d\epsilon_2, \gamma d\epsilon_3$. And the work done by the stresses will be

$$(1) \quad \frac{kF^2}{8\pi} \beta\gamma\alpha d\epsilon_1 = \frac{kF^2}{8\pi} d\Gamma d\epsilon_1;$$

$$(2) \quad -\frac{kF^2}{8\pi} \gamma\alpha\beta d\epsilon_2 = -\frac{kF^2}{8\pi} d\Gamma d\epsilon_2;$$

$$(3) \quad -\frac{kF^2}{8\pi} \alpha\beta\gamma d\epsilon_3 = -\frac{kF^2}{8\pi} d\Gamma d\epsilon_3;$$

$$\therefore dW = \frac{kF dF}{4\pi} d\Gamma = \frac{kF^2}{8\pi} d\Gamma (d\epsilon_1 - d\epsilon_2 - d\epsilon_3)$$

$$\therefore \epsilon_1 - \epsilon_2 - \epsilon_3 = \log F^2 + \text{const.}$$

[Poincaré, *Electricité et Optique*.]

Now, this equation cannot obviously be satisfied, if we regard electrostatic phenomena as involving no intrinsic energy (*i. e.* $\epsilon_1 = 0 = \epsilon_2 = \epsilon_3 = F$, at the same time); but if we can postulate a certain amount of *intrinsic* energy, we are able to do so. Thus, if we suppose

$$\epsilon_1 = \epsilon_2 = \epsilon_3 = 0, \text{ when } F = F_0, \text{ we have } \epsilon_1 - \epsilon_2 - \epsilon_3 = \log \frac{F^2}{F_0^2},$$

and this is obviously admissible [with a further limitation on the arbitrariness of the quantities $\epsilon_1, \epsilon_2, \epsilon_3$].

16. All these theories are thus seen to converge to the same point.

17. Again, from the principle of energy

$$T + V = C' \text{ (constant) } \dots \dots \dots (3)$$

Therefore from (1) and (3) we get

$$\left. \begin{aligned} 2T &= C' + C \\ 2V &= C' - C \end{aligned} \right\}.$$

But this is meaningless, since the *mean* potential energy and the mean kinetic energy are alone constant, as these quantities are understood to mean in the above equations. Accordingly, the only conclusion that seems to be consistent with all the equations is that *the optical energy is entirely kinetic*.

The equation (1) then becomes $T=A$, the equation (2) disappears and the equation (3) becomes $T'=A'$, and $T'-T=A'-A$ =intrinsic energy.

Again, if the potential energy of deformation of the æthereal medium involved in light propagation is to be regarded as essentially kinetic, we are led to conclude that *all energy is kinetic*.

18. This view of the intimate nature of energy intrinsic or otherwise is partially accepted in effect, in different branches of Physics. Thus, on the kinetic theory of gases, the pressure of a gas has a kinetic origin and, in fact, all cases of equilibrium in molecular physics are best explained as those of mobile or convective equilibrium.

19. But, if the interpretation of Fermat's law, sketched above, is admissible, we are led to a further generalization—to regard the *energy of mere configuration, also, as kinetic*. We must, in fact, conceive some subtle æthereal motion, being associated with every given configuration of a conservative system, existing in the field; thus the so-called potential energy of a vibrating system at any moment is, in reality, kinetic energy *of the field*. It follows, therefore, that the phenomena of elasticity are to be regarded as intrinsically kinetic, and remembering the intimate relation between electrostatics and the phenomena of elasticity, developed by Maxwell and others, we are led to conclude that *electrostatic phenomena are also kinetic*.

20. An indirect verification of the last conclusion may be derived from an application of the compatibility equations of St. Venant to the theory of electrostatic stress developed by Maxwell, at any rate, if we assume that the system of stresses in an electrostatic field is that given by Maxwell. For this, let e_{xx} , e_{xy} , &c. be the strains at any point. Then it is easy to show that the above system of strains is given by

$$e_{xx} = \frac{k}{8\pi E} (1 + 2\sigma) F^2,$$

where k is the specific inductive capacity, E is Young's modulus, and σ is Poisson's ratio, and

$$e_{xy} = 0, \text{ \&c.},$$

$$e_{yy} = -\frac{F^2 k}{8\pi E}, \text{ \&c.}$$

Applying the compatibility equations, we have

$$\left(\frac{\partial^2}{\partial y^2} + \frac{\partial^2}{\partial z^2}\right)F^2 = 0,$$

$$\left(-\frac{\partial^2}{\partial x^2} + (1 + 2\sigma)\frac{\partial^2}{\partial z^2}\right)F^2 = 0,$$

$$\left(-\frac{\partial^2}{\partial x^2}(1 + 2\sigma) - \frac{\partial^2}{\partial z^2}\right)F^2 = 0,$$

$$\frac{\partial^2 F}{\partial y \partial z} = 0, \text{ \&c.}$$

Hence $F^2 = ax + by + cz + \text{constant}$, which is, obviously, impossible.

If, however, the phenomena are not statical, the above argument does not apply.

21. It should be remarked, however, what indeed experiments seem to indicate, that the distribution of electrostatic stress in a dielectric medium is not so simple as Maxwell supposed, so that the assumption virtually made by Maxwell that the principal axes of stress (agreeably to Faraday's views) are along and perpendicular to the lines of force, seems to be only a first approximation.

Experiments moreover suggest, as has been remarked by J. J. Thomson, that there must be forces in the electric field not recognized by Maxwell's theory. These peculiarities of the field seem to be intimately related to the fact that the field is essentially one of *kinetic energy*.

22. We may picture to ourselves the intimate processes going on in an æthereal medium which is the seat of electrical or optical energy, by means of the moving Faraday tubes of J. J. Thomson. On this view, the Faraday tubes are supposed to move with the velocity of light and both electric and magnetic forces and electric polarization, and therefore the state of energy of the field, can be completely represented by these motions. ('Recent Researches.')

23. To show this, let the electric displacement across any surface be equal to the difference in the number of tubes that enter and leave the surface and f, g, h their components

parallel to the axes, and l, m, n the direction-cosines of an element of surface.

Then, since in any limited region the total number must remain unchanged,

$$\begin{aligned} \frac{d}{dt} \int (lf + mg + nh) dS &= 0 \equiv \frac{d}{dt} \int R_n dS \text{ (say)} \\ &= \int (lf' + mg' + nh') dS + \text{terms depending on the motion} \\ &\quad \text{of the tubes,} \\ &\quad \left[f' \equiv \frac{df}{dt}, \text{ \&c.} \right]. \end{aligned}$$

Suppose the tubes across dS spread over dS' on account of this velocity, then the terms depending on the velocity

$$= \int (R_n' dS' - R_n dS).$$

Consider the volume enclosed by dS and dS' . The total surface integral over this surface

$$= - \left(\frac{\partial f}{\partial x} + \frac{\partial g}{\partial y} + \frac{\partial h}{\partial z} \right) dx dy dz.$$

But this must be

$$= - R_n' dS' + R_n dS + \text{surface integrals over the tubular surface generated by the contour of } dS.$$

Now, if ds = an element of arc of dS (at x, y, z),

U = velocity of a tube, so that

$U dt$ = length of the line joining corresponding points of dS and dS' ,

ϵ = inclination of ds to the direction of the displacement of a tube ;

then, $ds U dt \sin \epsilon$ = area of the portion of the tubular surface generated by ds .

Then, the surface integral over the tubular surface

$$\begin{aligned} &= \int R_n ds dt U \sin \epsilon \\ &= \begin{vmatrix} dx & dy & dz \\ f & g & h \\ u & v & w \end{vmatrix} dt \end{aligned}$$

where u, v, w are the component velocities of a tube corresponding to the velocity U ,

$$\equiv (L dx + M dy + N dz) dt \text{ (say)}$$

where

$$L, M, N = (gw - vh), \quad (uh - fw), \quad (fv - ug).$$

But

$$\int (Ldx + Mdy + Ndz) = \int dS \left\{ l \left(\frac{\partial N}{\partial y} - \frac{\partial M}{\partial z} \right) + + \right\}.$$

Hence

$$\begin{aligned} & - \left(\frac{\partial f}{\partial x} + + \right) U dt dS \cos \mu \\ & = -\partial(RdS) + dSdt \left\{ l \left(\frac{\partial N}{\partial y} - \frac{\partial M}{\partial z} \right) + + \right\}, \end{aligned}$$

where μ = angle between the direction of motion of the tube and the normal to dS , and moreover

$$U \cos \mu = lu + mv + nw.$$

Hence we have

$$\begin{aligned} & (lu + mv + nw) \left(\frac{\partial f}{\partial x} + + \right) dS dt \\ & = \partial(RdS) - \left[l \left(\frac{\partial N}{\partial y} - \frac{\partial M}{\partial z} \right) + + \right] dS dt. \\ \therefore \frac{d}{dt} \int (lf' + mg + nh) dS \\ & = \int (lf' + mg' + nh') dS + (lu + nv + mw) \left(\frac{\partial f}{\partial x} + + \right) \\ & \quad + \int dS \left\{ l \left(\frac{\partial N}{\partial y} - \frac{\partial M}{\partial z} \right) + + \right\} = 0. \end{aligned}$$

We get, accordingly,

$$\frac{df}{dt} = f' = -u \left(\frac{\partial f}{\partial x} + \frac{\partial g}{\partial y} + \frac{\partial h}{\partial z} \right) + \frac{\partial}{\partial y} (ug - vf) - \frac{\partial}{\partial z} (wf - vh).$$

But

$$\frac{\partial f}{\partial x} + \frac{\partial g}{\partial y} + \frac{\partial h}{\partial z} = \rho = \text{volume density of electrification.}$$

$$\therefore f' + u\rho = \frac{\partial}{\partial y} (ug - vf) - \frac{\partial}{\partial z} (wf - vh)$$

= p , where p is the total current in the direction of x .

This agrees with Thomson's results, though we have followed a different mode of analysis.

Again, since, on Maxwell's theory,

$$4\pi p = \frac{\partial \gamma}{\partial y} - \frac{\partial \beta}{\partial z}, \text{ \&c.,}$$

where α, β, γ are the components of magnetic force,

$$\alpha = 4\pi(vh - wg), \text{ \&c.,}$$

showing that Faraday tubes in motion give rise to a magnetic field.

Moreover, if we take the kinetic energy

$$T = \frac{\mu}{8\pi} (\alpha^2 + \beta^2 + \gamma^2),$$

we have the momentum of the tubes, or the momentum of the medium in the direction of x ,

$$\begin{aligned} &= \frac{\partial T}{\partial u} = \frac{\mu}{4\pi} \left(\alpha \frac{\partial \alpha}{\partial x} + + \right) \\ &= (gc - hb) \end{aligned}$$

where a, b, c are the components of the magnetic induction.

This system of momenta in the field is found to be "proportional to amounts of energy transferred in unit time across unit plane at right angles to the axes of x, y, z in Poynting's theory of the transfer of energy in the electromagnetic field." Hence the direction of momentum coincides with the direction of flow of energy, on this theory.

Again, on the assumption that T may also be taken to be equal to

$$\frac{2\pi}{k} (f^2 + g^2 + h^2),$$

we have

$$\frac{4\pi f}{k} = wb - vc = X, \text{ \&c.}$$

(i. e. electromotive intensity (X, Y, Z) is due to the motion of Faraday tubes only).

And since

$$b = 4\pi\mu(fw - hu),$$

$$c = 4\pi\mu(gu - fv),$$

we have

$$f = \mu k \{ f(u^2 + v^2 + w^2) - u(fu + gv + hw) \}, \text{ \&c.}$$

\therefore multiplying in order by u, v, w , we have

$$fu + gv + hw = 0,$$

and \therefore

$$u^2 + v^2 + w^2 = \frac{1}{\mu k} = V^2,$$

where V is the velocity of light in the medium.

That is, the tubes move with the velocity of light at right angles to the direction of polarization and also at right angles to the direction of the magnetic force. The energy of the electromagnetic field is seen, therefore, on this view to be entirely kinetic. [Art. 26.]

24. A further point may be noted. Since the luminiferous medium is an electromagnetic field, and the properties of the former have been partially explained by identifying it with an elastic medium, we may take

$$(f, g, h) = (w_x, w_y, w_z) \text{ (molecular rotations),}$$

$$(\alpha, \beta, \gamma) = (\xi', \eta', \xi'),$$

ξ, η, ξ being the elastic displacements, and

$$\xi' = \frac{d\xi}{dt}, \text{ \&c.}$$

Moreover, assuming that the æthereal (or optical) medium is a fluid medium, we may obviously note the analogies between quantities in Hydrodynamics and Electromagnetism, viz.,

U, V, W (velocity of flow) to α, β, γ (magnetic force),

$\Omega_x, \Omega_y, \Omega_z$ (vortex spins) to u, v, w (currents).

Larmor has developed a dynamical theory of the electromagnetic field based on this two-fold concordance. The theory presents difficulties, but its most noticeable feature from the present point of view is that it leads to the postulate of a kinetic origin for the whole of the energy of the field (including intrinsic energy).

25. Now, the main difficulty of the above theory arises (as Larmor has pointed out) from the fact that it is "not very successful in unravelling the detailed relations of æther and matter. Conception of free electrons effectively removes this difficulty." But the theory of electrons, as explaining the properties of the electromagnetic field, emphatically brings into relief the existence of a certain amount of intrinsic energy and the kinetic nature of the total energy of the system. This, we propose to develop in a future paper.

26. Again, since electrons or negative charges are electrified singularities in the field, Faraday tubes must be conceived to be issuing from these. These tubes on J. J. Thomson's theory move, as we have just seen, with the velocity of light through the medium. The mode of light propagation or its mechanism may, therefore, be thus stated in terms of moving Faraday tubes.

27. From a source of electromagnetic energy issue "Faraday tubes" which move through the medium at right angles to themselves along the line of energy flow (with the velocity of light). If the electromagnetic energy suffers periodic variation, the number of tubes issuing will also suffer periodic variation.

This mode of representation, as J. J. Thomson has remarked,

recalls the emission theory developed by Newton, while the main features of the undulatory theory are conserved. But the emission theory definitely postulates the kinetic nature of the whole of the optical energy in a medium—in strict accordance with Fermat's law. We conclude, accordingly, that either theory leads to the same conclusion.

28. Again, the motion of the Faraday tubes, in a medium, which may be taken to be a fluid medium of some kind, recalls the "motion of hollow vortex rings in a fluid in which portions in rotational and irrotational motion are freely mixed together and which Lord Kelvin has called vortex sponge." Now it has been shown that the equation of propagation of a plane wave in such a medium is the same as the equation of propagation of luminous vibrations in the æther, and that a spiral vortex in such a medium would behave in the same way as a tube of electric force. If this view of the electromagnetic field is accepted, the energy of the field intrinsic and actual must necessarily be entirely kinetic.

29. Finally, whether we view an atom as a vortex ring or simply regard it as made up of corpuscles and ions in rapid rotation, a molecule must be regarded intrinsically as a conservative system, whose energy is entirely kinetic, on any theory which at all holds the field. As further, we have argued that vibratory energy is also entirely kinetic, we reach the broad generalization that every form of energy involves motion, æthereal, corpuscular, or molar.

VI. *The Effect of Temperature and Magnetization on the Resistance of Graphite.* By DAVID E. ROBERTS, B.Sc.,
Research Fellow of the University of Wales*.

NOTATION.

θ	= Temperature.
\mathfrak{H}	= Intensity of magnetic field.
R_0	= Resistance in zero field at 0° .
R	= Resistance in zero field at θ° .
R'	= Resistance in field \mathfrak{H} at θ° .
A, a	= Empirical constants.
m	= Exponential constant.
ϕ	= Angle between \mathfrak{H} and crystalline axis (\mathfrak{A}).

THE investigations of Grunmach and Weidert*, Patterson†, and others, on the effect of transverse magnetization on the electrical resistance of various substances, show that paramagnetic and diamagnetic metals

* Communicated by Dr. H. du Bois. A preliminary publication appeared in Proc. Roy. Acad. Amst. xxi. p. 221 (1912).

† L. Grunmach and F. Weidert, *Ann. der Phys.* xxii. p. 141 (1907).

‡ J. Patterson, *Phil. Mag.* [6] iii. p. 643 (1902).

exhibit an increase of resistance when magnetized, while the three ferromagnetic metals, at least in sufficiently strong transverse fields, show a decrease. Although, as yet, no simple relation has been found to exist between the order of magnitude of this effect and the corresponding magnetic susceptibility, it may be noticed that the effect is a hundred times greater for diamagnetic cadmium than for paramagnetic tantalum and again a thousand times greater for bismuth. This element, as is well known, possesses rather a high diamagnetic specific susceptibility ($-1.40 \cdot 10^{-6}$). Soon after Morris Owen* found Ceylon graphite to show the highest susceptibility yet observed, Dr. W. J. de Haas was led by analogy to anticipate that graphite might exhibit a variation of resistance of an even higher order when magnetized, and suggested to me to search for the effect. The preliminary experiments † performed with powdered graphite pressed into a thin plate, with irregularly shaped pieces, and with ordinary pencils, amply satisfied expectation, and justified an extended investigation of the phenomenon. Graphite crystallizes in the hexagonal rhombohedral (or according to the new notation, the ditrigonal scalenohedral) form; it was once assigned to the monoclinic class of crystals, but latterly this view appears to have little support. Fairly well-defined crystalline pieces are, with few exceptions, only found in Pargas (Finland) and Ticonderoga (New York); of the former I succeeded in obtaining a few specimens. Most frequently graphite is found filling veins, or in compact laminated masses, or as isolated flakes or scales embedded in the older crystalline rocks; it possesses perfect basal cleavage, and can thus be obtained in thin plates or flakes which are soft and flexible but not elastic.

Its density appears to be very variable. Le Chatelier and Wologdin ‡ have systematically investigated artificial graphite made after Acheson and that obtained from cast-iron, as well as native graphite from Scharzbach and Mograu (Bohemia), Siberia, Ceylon, and Australia. The density varied between 1.6 and 2.2; after the graphite had been purified by solutions of potash, &c., and subjected to pressure, all the samples agreed in giving a density of 2.255 (H_2O at $4^{\circ} C.$). Lime, silicic acid, iron, and carburetted hydrogen

* Morris Owen, *Versl. Afd. Natuurkd.* xx. p. 673 (1911); *Ann. der Physik*, xxxvii. p. 657 (1912).

† When transversely magnetized in a field of 20 kgs. the compressed Ceylon graphite gave an increase of resistance of 52 per cent.; an irregularly-shaped piece gave an increase of 219 per cent.; HB and SB pencils by A. W. Faber gave only a 3 per cent. increase. The best sample G.I. 15 gave as much as 400 per cent.

‡ H. le Chatelier and S. Wologdin, *Compt. Rend.* cxlvi. p. 49 (1908).

occur in minute quantities as impurities; many varieties contain as much as 99 per cent. of pure carbon. The chemical structure of graphite is probably a complicated one, but above 370° C. graphite is the most stable of the three allotropic modifications of carbon. Its optical constants were lately determined by Zakrewski*.

Several properties of graphite have been investigated by Koenigsberger † and his co-workers; its conductivity for heat along its base-plane and also at right angles to its axis was found to have a very high value, viz., 0.85 (cal./cm. sec. °C.), which nearly equals that of copper (0.9); this does not, however, at all agree with the law of Wiedemann and Franz.

They further (*l.c.*) investigated its thermoelectric effect (compared with copper) and its Thomson effect, but found here no extreme values.

According to a private communication kindly sent to me by Prof. Koenigsberger, Gottstein ‡ found for the Hall effect in the variety of graphite which I term below G V., $R = -0.71$. In the case of variety I., which I preferably worked with, the Hall effect was found in an experiment by Washburne to be of the same order, but showed marked dissymmetry.

The following values of the specific resistance of graphite were found by Muraoka, Artom, Piesch, Koenigsberger and Weiss§:—

Ceylon graphite at 0°	12.10 ⁻⁴ ohm per c.c.
Siberian graphite at 0°	11.10 ⁻⁴ „ „
Greenland graphite at 15° ...	4.10 ⁻⁴ „ „
Ceylon graphite at 16°	3.6.10 ⁻⁴ „ „

On the other hand, my best graphite pieces of the variety GI. gave a specific resistance as low as 0.5 . 10⁻⁴, *i. e.* almost half that of mercury (0.96 . 10⁻⁴ at 18°). This material also, at ordinary temperatures, showed an *increase* of resistance of +0.001 per degree rise of temperature, while at high and low temperatures the increase was +0.0025 per degree

* K. Zakrewski, *Bull. Int. Acad. Cracow*, (A) xxii. p. 122 (1910).

† J. Koenigsberger and J. Weiss, *Ann. d. Phys.* xxxv. p. 27 (1911); *Verh. d. Phys. Ges.* xiv. p. 9 (1912); J. Weiss, *Inaug.-Diss.*, Freiburg i. B. (1910).

‡ This will soon be published in a Dissertation.

§ Cf. *Handb. d. Anorg. Chem.* iii. (2 Abt.) p. 54 (1909); J. Koenigsberger and J. Weiss, *Ann. d. Pys.* xxxv. p. 2 (1911).

(cf. fig. 3). On the other hand, Koenigsberger and Reichenheim* found a decrease of resistance of one half by a rise of temperature from -185° to $+191^{\circ}$. According to Clay †, the resistance of a glow-lamp filament decreases by 24 per cent. on heating it from -255° to 0° . The specific resistance of amorphous carbon has always been found to be much greater and a decrease accompanies increase of temperature; the temperature coefficient becomes numerically smaller as the change into the graphite modification proceeds, but no change in sign has previously been noticed ‡. Such a phenomenon has recently been observed by von Pirani § in the case of the so-called metallized filaments. Thick filaments, free from ash, carbonized twice above 2500° , showed finally the smallest specific resistance and a small positive temperature coefficient $+0.00007$, which is exceeded by the above (variety G I.) thirty-five times. From this it appears possible to obtain preparations, having a vanishingly small temperature coefficient, which could be used as standard resistances ||.

The effect of magnetization on the resistance of graphite was investigated by Patterson (*loc. cit.*), who found the resistance of a glow-lamp filament increased by 0.027 per cent. in a transverse field of 25 kgss. Laws ¶ has also investigated the effect for glow-lamp filaments, pencils, and for graphite, without, however, finding it to be of an exceptionally high order. At ordinary temperatures he found the increase of resistance of graphite in a transverse field of 11 kgss. to be only 1 per cent. of the resistance outside the field, while at the temperature of liquid air the effect appeared to be increased threefold. Within the small limits of his field it was found that the increase of resistance was proportional to the square of the field, and between the temperatures -186° and $+18^{\circ}$, inversely proportional to the absolute temperature. From what follows it will be seen

* J. Koenigsberger and O. Reichenheim, *Physik. Zeitsch.* vii. p. 575 (1906).

† J. Clay, *Inaug.-Diss.*, Leiden, 1908.

‡ Cf. *Handb. d. Phys.* iv. p. 380 (1905); G. Wiedemann, *Elektrizität*, i. p. 539 (1882).

§ Unpublished communication, from Dr. M. v. Pirani to Prof. Koenigsberger, and kindly sent to me by the latter.

|| Since my first communication, *Versl. Kon. Akad. Wet. Amst.* xxi. p. 221 (1912), this suggestion has been made by H. Kost, *Physik. Zeitschr.* xiii. p. 896 (1912).

¶ S. C. Laws, *Phil. Mag.* [6] xix. p. 694 (1910). He investigated graphite from the Morgan Crucible Co., London.

that his results are not in agreement with those obtained with my specimens.

Regarding the resistance effect in the case of crystallized bismuth, von Everdingen * found that the resistance outside the field could be represented by an ellipsoid of conductivity, the axis of rotation of which bore to the rectangular axes the relations $\sqrt{3} : \sqrt{5}$. If the crystalline axis was placed to coincide with that of the field, an ellipsoid of revolution was again obtained with a slightly different relation between the axes. If the crystalline axis was placed perpendicular to the field, the ellipsoid in this case had three different axes with marked differences in their relation to one another; for inclined positions similar results hold in accordance with the principle of superposition. The relation between the transverse and longitudinal effect has been investigated by Lenard † for a "filament" from compressed bismuth containing zinc and iron; the resistance for an alternating current was measured for different angles ψ between the filament (referred to the direction of the measuring current) and the field, and the results represented by the purely empirical formula

$$\frac{R' - R}{R} = A + B \cdot \sin^2 \psi - C \sin^2 2\psi \cos 2\psi.$$

The influence of temperature and transverse magnetization on the resistance (for steady currents) of pure diamagnetic electrolytic bismuth and of ferromagnetic "pure nickel" (commercial) was investigated in detail in this laboratory by Blake; his publication contains an extensive summary of the new literature on this subject.

The longitudinal effect in nickel was investigated simultaneously by du Bois ‡. Quite recently Kamerlingh Onnes and Beckmann § have published measurements on bismuth, copper, iron, gold, and palladium at temperatures below -200° .

I. *Experimental Arrangement.*

The specimens most used in the investigation were prepared from the same commercial Ceylon graphite (afterwards

* E. v. Everdingen, *Arch. néerl.* [2] iv. p. 462 (1901).

† P. L. Lenard, *Wied. Ann.* xxxix. p. 646 (1890)

‡ F. C. Blake, *Ann. d. Phys.* xxviii. p. 449 (1909); H. du Bois, *Verh. Ned. nat. Congress*, xii. p. 128, Utrecht (1909); cf. E. A. Owen, *Phil. Mag.* [6] xxi. p. 122 (1911); C. W. Heaps, *Phil. Mag.* [6] xxii. p. 900 (1911), and xxiv. p. 813 (1912).

§ H. Kamerlingh Onnes and B. Beckmann, *Versl. Kon. Akad. Wet. Amst.* xxi. pp. 263, 478, 481, 881 (1912).

referred to as G I.) as that used by Owen in his researches on its thermo-magnetical properties; a chemical analysis gave 0.19 per cent. of iron for one of his samples. In addition, tests were also made on the following different kinds:—

II. Ceylon graphite from the Comptoir minéralogique, Geneva, for which I have to thank Prof. du Bois. It was easily cleavable but not of a uniform structure, so that the cleavage plane was not sufficiently definite.

III. Ceylon graphite from Himbuluwa having internally a fine granular structure; its surfaces were highly polished but left no mark when rubbed on paper. For this specimen I am indebted to Prof. Grünling*, Munich.

IV. Graphite from the Limberg mine, Pargas (Finland), consisting of crystallized flakes imbedded in limestone and easily cleavable parallel to their surface. Mr. Magnus Wegelius kindly sent me specimens of this kind.

V. Ceylon graphite, for which I am indebted to Prof. Koenigsberger, Freiburg i. B., irregularly cleavable in all directions.

VI. Graphite, which had been used by Dr. Reichenheim, and which was also sent to me by Prof. Koenigsberger. It was not regularly cleavable although small plates, apparently crystalline, could be obtained.

Chemical tests for the presence of ferruginous and other impurities could not, up to the present, be carried out.

In the investigations on graphite I. short rectangular pieces (7–10 mm. long, 1–2 mm. broad, and 0.1–0.5 mm. thick) were obtained by careful cleavage, and those selected for investigation which appeared of most pronounced and uniform crystalline structure.

It was found only possible to prepare specimens cut parallel to the crystalline bases or cleavage plane; suitable pieces with their lengths parallel to the crystalline axis could not be obtained.

For the determination of the effect of transverse magnetization they were, in general, supported in the field so that the cleavage planes were perpendicular to the lines of force, which were thus parallel to the crystalline axis. On supporting the pieces freely in a magnetic field, it was observed that they moved so that the crystalline axis set itself perpendicular to the field, this axis thus coinciding with the direction of maximum diamagnetic susceptibility, which according to Owen may reach a value of -15 millionths.

* A. Grünling, *Zeitschr. f. Krist. u. Mineral.* xxxiii. p. 208 (1900).

The resistance of the graphite specimens, both in and out of the fields, was determined by a potentiometer method*, being compared directly with known resistances (0·1–1·0 ohm). The current and potentiometer leads were soldered to the ends of the specimen investigated, which were previously coppered electrolytically. In the rotation experiments the four leads, which consisted of four insulated straight copper wires, about 30 cm. long and bound together by silk so as to form a fairly rigid rod, were fixed inside a metal tube. This tube could be turned within a second shorter coaxial tube rigidly attached to the frame of the electromagnet used, and carried a coaxial graduated disk. The angle of rotation was read off directly by means of a fixed pointer. The copper leads lay along the axis of rotation of the apparatus, and for the determination of the variation of the transverse effect with orientation of the graphite in the field, the graphite was soldered to the leads with its length along that of the leads and, for the determination of the longitudinal effect, at right angles to this position. The current through the graphite during a series of measurements was varied between 2 and 0·5 milliamperes according to its resistance. In order to eliminate thermoelectric and other junction effects† the current in the main circuit, as well as the potentiometer connexions, were successively reversed. The changes of resistance involved being considerable, it was found necessary to adjust the sensitiveness of the potentiometer during a single series of readings; this was initially sufficient to detect differences of 0·0001 ohm. Small irregular variations in the resistance of a particular specimen were observed after it was subjected to the action of magnetic fields or to widely different temperatures. This change, however, amounted in general to less than 1 per cent.; no evidence was ever found of any regular hysteresis with respect to the magnetic field or with temperature. Through the kindness of Prof. Hagen and Dr. Hoffmann, the resistance of specimen G I. 15—that used in the experiments at different temperatures—was redetermined at 18° C. in the Phys. Tech. Reichsanstalt by means of Diesselhorst's "compensation apparatus"‡ and a differential galvanometer: good agreement was found. Some of the preliminary measurements had been made with Wheatstone's bridge method, and when repeated potentiometrically, practically the same results were obtained.

* F. Kohlrausch, *Prakt. Physik*, ii. Auflage, p. 422 (1910).

† These were discussed in detail by F. C. Blake, *loc. cit.* p. 465.

‡ H. Diesselhorst, *Zeitschr. für Instr.kunde*, xxvi. pp. 173, 297 (1906); xxviii. pp. 1, 38 (1908).

To obtain the magnetic fields the latest large type 1911 model of the du Bois half-ring electromagnet was used. To obtain the highest fields at ordinary temperatures special prism-shaped pole end-pieces (XV.) were generally used—12 mm. long and 1.6 mm. wide: with these parallel end-pieces 0.7 mm. apart and a pair of extra polar coils a field of 50 kilogauss could be easily attained; this proved practically uniform over an equatorial length of 4 mm. and uniform within 1 per cent. over 8 mm. For observations at low and high temperatures the same thermomagnetic arrangement (XI.) was used as that adopted by du Bois and Wills*. The polar distance was 1.5 mm., the diameter of the frontal planes 7 mm., and the semi-angle 56° ; as the frontal planes were not sufficiently parallel the field proved uniform within about 1 per cent. only. For the determination of the transverse effect at ordinary temperatures at the lower fields, pole-shoes (VII.) (10–5 mm. apart) and then pole-end pieces VIII., with their frontal planes adjusted to be exactly parallel (2 mm. apart) were used, so that over the space occupied by the graphite a practically uniform field was obtained.

The uniformity of the field was tested by means of differential measurements with an exploring coil of only 1.3 mm. in diameter. The magnetic fields were measured by means of an exploring coil and a ballistic galvanometer in the usual way†. It was assumed that the fields were appreciably the same at all the temperatures used for a given current through the coils of the electromagnet‡.

II. Experiments at ordinary temperature (18° C.).

About twenty specimens of Ceylon graphite I. were investigated, which all gave variations of resistance of a very high order. The increase in a transverse field of 20 kilogauss, *e. g.*, varied between 300 and 500 per cent. of the resistance in zero field. Considering the difficulty of obtaining specimens of graphite of definite crystalline structure, and having regard to the impurities occurring in the natural substance, the variations in the magnitude of the effect are not surprising. About five specimens, which gave the greatest variation of resistance, were investigated more particularly;

* H. du Bois, *Zeitschr. für Instr.kunde*, xxxi. p. 369, fig. 9 (1911).

† H. du Bois, 'The Magnetic Circuit in Theory and Practice,' p. 300. London, 1896.

‡ P. Weiss and H. Kamerlingh Onnes, *Versl. Kon. Akad. Amst.* xviii. p. 794 (1910), find 2.1 per cent. for the increase of the saturation value on cooling from $+20^{\circ}$ C. to -253° C.

by analogy with the well-known behaviour of more or less pure bismuth*, the assumption appeared justifiable that these were more likely to be pure and perhaps of more uniform crystalline structure. Some of the specimens were supported free between thin mica or glass plates; when imbedded in sodium silicate, collodion, or Canada balsam allowed afterwards to solidify, they did not experience any change in the magnitude of their increase of resistance in the magnetic field, thus eliminating any doubts that the effects were due to bodily strains in the graphite. In the final experiments at different temperatures the graphite pieces were supported by thin flexible wires between thin mica plates, so as to avoid any strain due to possible expansion or contraction. The specimens could be mounted with their connexions so that the total thickness amounted to less than 0.7 mm., thus enabling them to be examined in fields up to 50 kilogauss. Some of the isothermal curves obtained for different specimens, transversely magnetized, at 18° C., with the cleavage plane normal to the field, are shown in fig. 1. The curves are for the specimens:—

Specimen.	Resistance R_0 .
G I. 4.....	0.043 ohm
G I. 10.....	0.080 "
G I. 11.....	0.016 "
G I. 12.....	0.043 "
G I. 15.....	0.032 "

Attempts to identify the curves with such equations as

$$\frac{R'}{R_0} = \frac{R}{R_0} + b\mathfrak{H} + c\mathfrak{H}^2 + \dots$$

failed; it was found, however, that all the curves obtained at ordinary temperatures could, well within experimental errors, be represented by the formula

$$\frac{R'}{R_0} = \frac{R}{R_0} + A\mathfrak{H}^m \dots \dots \dots (1)$$

Owing to the difficulty of determining the dimensions of

* F. C. Blake, *Ann. der Physik*, xxviii. p. 449 (1909).

the specimens, it is unfortunately impossible to give their absolute specific resistance with any exactitude.

Fig. 1.

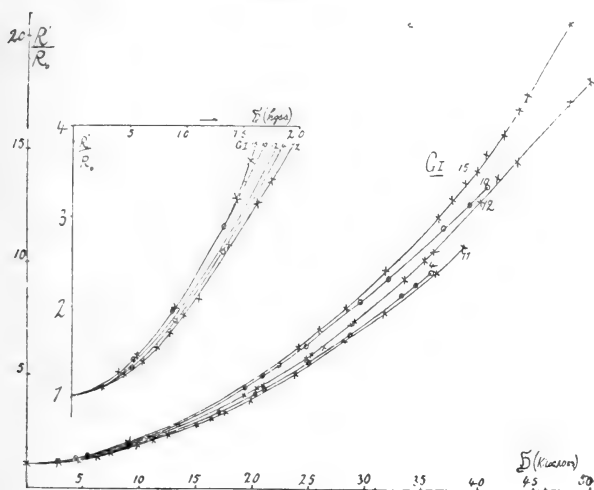

Isothermals (18°) G I.

From equation (1) we have, taking logarithms

$$\log \frac{R' - R}{R_0} = \log A + m \log H,$$

which can be represented by a straight line if A and (m) are really constants, the coordinates being $\log (R' - R)/R_0$ and $\log H$.

The values of $\log (R' - R)/R_0$ and $\log H$, corresponding to the points on the curves shown in fig. 1, when plotted were found to lie very nearly on straight lines practically parallel to one another, indicating that m is the same constant for each of these specimens G I. 4, 10, 11, 12, 15. In the case of G I. 15—the one which gave an increase in resistance of the greatest order—equation (1) did not hold so well as for the other specimens, although the mean value of m was the same for this as for the others. The values of A and m obtained for the different specimens are given in Table I.

For each specimen $m = 1.74^{15}$ *.

* Within the experimental errors the exponent may also be $m = \sqrt{3} = 1.732$ or $m = 7/4$.

TABLE I.
Transverse magnetization. Cleavage plane normal
to the field.

Isothermals at 18° C.		
Specimen.	R_0 .	$R'/R_0 = R/R_0 + A\mathfrak{G}^m$.
G I. 4.....	0.0430 ohm	1.01 + 0.0171 $\mathfrak{G}^{1.745}$
G I. 10.....	0.0792 „	1.01 + 0.0205 $\mathfrak{G}^{1.745}$
G I. 11.....	0.0162 „	1.008 + 0.0162 $\mathfrak{G}^{1.745}$
G I. 12.....	0.0430 „	1.014 + 0.0188 $\mathfrak{G}^{1.745}$
G I. 12a	0.0323 „	1.01 + 0.0198 $\mathfrak{G}^{1.745}$
G I. 15.....	0.0316 „	1.02 + 0.0214 $\mathfrak{G}^{1.745}$

The results of the tests, which were made on the other kinds of graphite (see p. 163), which all showed the effect in a lesser degree or not at all, were as follows:—

G II. The best piece I could prepare gave an increase of resistance of only 182 per cent. in a field of 20 kilogauss, the resistance out of the field being 0.0427 ohm.

G III. Different pieces of this graphite gave quite different results. A thin strip obtained from the upper smooth and highly polished surface by cleavage, appeared on its underside of a fine granular structure. When transversely magnetized in a field of 20 kilogauss it showed an increase of resistance of 220 per cent., the resistance outside the field being 0.0786 ohm. A thin strip obtained from the underside of the same material, and having a high natural polish on both of its surfaces, gave the anomalous results. Its resistance outside the field was several hundred ohms, and diminished very rapidly with increase of temperature. In a magnetic field, however, no change in its resistance could be detected, while rough experiments indicated that it was paramagnetic. Three pieces similar to the latter were tested and agreed in giving these anomalous results.

G IV. The piece tested possessed a specific resistance of about $15 \cdot 10^{-4}$ ohm per cm.^3 , *i. e.* of the same order as the average of G I. When transversely magnetized it showed an increase of resistance of 440 per cent. in a field of 26 kilogauss. Its initial resistance was 0.009 ohm. It appeared to be strongly diamagnetic.

G V. The best piece of this kind which I could prepare gave a specific resistance of about $15.6 \cdot 10^{-4}$ ohm per cm.^3 , and in a transverse field of 26 kilogauss it showed an increase of resistance of 163 per cent. It appeared to be diamagnetic.

G VI. Three pieces of this kind were tested, and these behaved similarly to graphite III. They possessed a very high specific resistance (2.14 ohm per cm.^3), and showed very marked decrease of resistance with increase of temperature (about 6 per cent. per degree). In a magnetic field of 26 kilogauss no change of resistance could be observed, although a change of 0.001 per cent. could have been detected. The material appeared to be strongly paramagnetic, which may be due to ferruginous impurities.

III. Orientation of the Graphite in the Magnetic Field (19° – 22° C.).

Preliminary observations with G I. 12 showed that in transverse fields the change of resistance of the graphite depended greatly on the angle ϕ between the crystalline axis \mathfrak{A} and the magnetic field \mathfrak{H} . Thus the effect of a transverse field of 26 kilogauss, as expressed by the value of $(R' - R)/R$, was rather more than 5 when the crystalline axis was parallel to the field, and only 0.15 when the axis was normal to the field. To investigate in detail the variation of the change of resistance with the angle between the crystalline and field axes, G I. 12 *a* (G I. 12 shortened and re-coppered) was used. It was remounted and supported in the magnetic field as described above, so that it could be rotated about an axis normal to the field (*a*) with its length along the axis of rotation, the graphite in this case being always magnetized transversely to its length and the direction of the measuring current, and (*b*) with its length normal to the axis of rotation.

In the latter case the graphite became successively transversely (cleavage plane normal to the field) and longitudinally magnetized as rotated through 90° .

In such investigations as this it is essential to have the magnetic fields as uniform as possible, and this condition was attained by determining the topography of the field for different distances between the pole end-pieces and adjusting this distance until uniformity was secured*.

* This problem was mathematically discussed by Prof. du Bois, *Versl. Kon. Akad. Wet. Amst.* xxi. p. 355 (1912); *Verh. d. D. Phys. Ges.* xiv. p. 758 (1912).

In case (a) pole end-pieces (VIII.) of frontal diameter 12 mm. were used, and the distance between them found to be very nearly 2 mm. for most uniform field when the current through the magnet was sufficient to saturate the iron. This is in good agreement with the theory referred to in the footnote (p. 169). The adjustment can be very exactly made, and finally a field uniform to within less than 1 per cent. was obtained over a transverse range of 8 mm. The

Fig. 2.

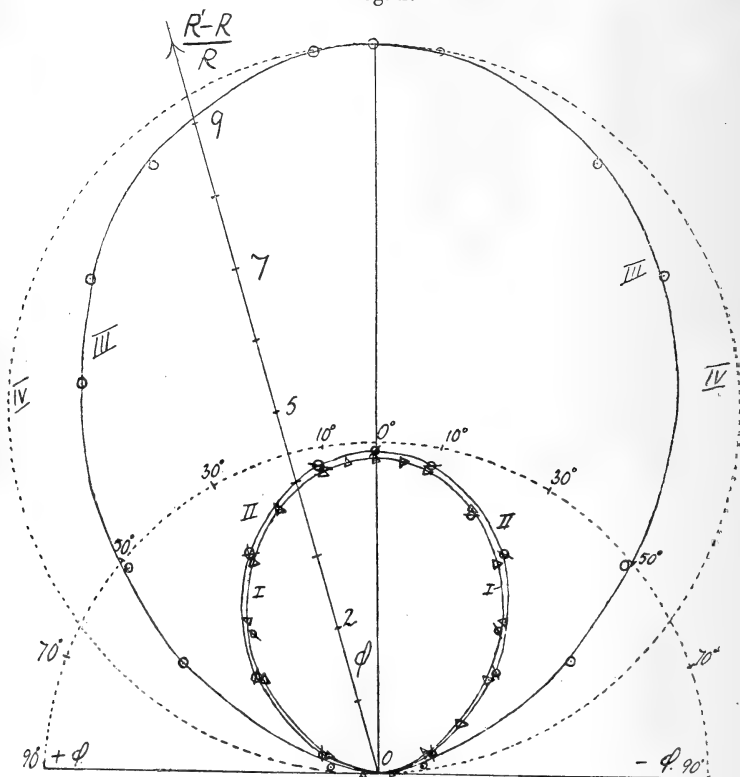

Orientation Curves.

resistance of specimen G I. 12 a was determined potentiometrically as before for different inclinations of its crystalline axis to the field as it was rotated through 360° in uniform transverse fields of 21.8 and 35.2 kgss. respectively. The increase of resistance was always *positive*, being a maximum or a minimum when the cleavage plane was normal or parallel to the field respectively. The results obtained are shown in fig. 2. Curves I. and III. are for a rotation through 180° ;

a further rotation gives again equal corresponding values: $(R' - R)/R$ is plotted radially, the angles ϕ shown being those between the field and the crystalline axis,

i. e. $(R' - R)/R = \text{the radius vector } \rho = \text{function } (\phi)$.

The radius vectors of the curves I. and III. represent the effect for the fields 21.8 and 35.2 kgss. respectively.

Determinations of the change of resistance with magnetic field were also made for the maximum and minimum positions, and are given in Table II. in the second and third columns. The numbers in the second column correspond, *mutatis mutandis**, to the curves in fig. 1.

In case (*b*) no end-pieces were used but only pole-shoes (VII.) of end diameter 43 mm., and at a distance apart of 8.5 mm. The field was practically uniform at this distance. After the graphite had been necessarily differently mounted, the (*b*) position, the variation of the resistance was determined for $H = 21.9$ kgss. as the graphite was rotated from the longitudinal to the transverse position. As the rotation was carried through 360° practically equal corresponding values were obtained in each quadrant, showing that the increase of resistance is perfectly independent of the direction of the current relative to the field and dependent only on the acute angle between the crystalline and field axes. The results for a rotation of 180° are shown in fig. 2, curve II. It will be noticed that this curve nearly coincides with curve No. I.; and remembering the difference in the field (21.9 and 21.8 kilogauss) we may conclude that, within experimental errors, the value of $(R' - R)/R$ depends only on the orientation of the crystalline axis in the field. The variation of $(R' - R)/R$ with longitudinal field is given in Table II., column four.

The results obtained for G I. 12 *a* when transversely magnetized, with the crystalline axis parallel to the field, follow the empirical formula (1) well within experimental errors. ($m = 1.74^5$. $A = 0.0198$.)

For the cases when the graphite has its axis normal to the field and is transversely or longitudinally magnetized the agreement is not so good. The resistances measured and the changes involved are, however, always small, and the experimental errors of greater influence. At the higher

* As the experiments described in this section were carried out at temperatures ($19^\circ - 22^\circ$ C), $(R' - R)/R$ has been considered instead of $(R' - R)/R_0$; the expressions differ only by the constant $1 - \frac{R}{R_0}$, which differs very little from zero.

TABLE II.—G I. 12 a. Temp. 20° C.

H kgss.	Transverse Magnetization.		Longitudinal Magnetization. H _⊥ H.
	Maximum (R' - R)/R. H _∥ H.	Minimum (R' - R)/R. H _⊥ H.	(R' - R)/R.
5.73	0.40	0.008	0.010
9.60	1.04	0.020	0.020
14.78	2.16	0.040	0.040
20.3	3.91	0.070	0.075
21.9	4.56	0.083	0.082
23.2	4.75	0.092	0.092
26.15	5.91	0.115	
29.75	7.36	0.148	
33.98	9.28	0.172	
35.2	9.89	0.189	
36.4	10.5	0.194	

fields the agreement is better. In the orientation experiments, assuming formula (1) to be true, it is reasonable to expect that (R' - R)/R should now be given by an equation such as

$$\frac{R' - R}{R} = A \cdot H_{\parallel}^m + A' \cdot H_{\perp}^{m'}$$

where H_∥ denotes the component of the field along the axis, and H_⊥ that at right angles.

Or
$$\frac{R' - R}{R} = A (\cdot H \cos \phi)^m + A' (\cdot H \sin \phi)^{m'}$$

and this, since H is kept constant, may be written

$$\frac{R' - R}{R} = 2a \cos^m \phi + 2a' \sin^{m'} \phi. \dots (2)$$

Here 2a and 2a' are constants, and are experimentally determined when φ = 0 or π/2 respectively.

Applying equation (2) to the experimental points given in fig. 2, curve III., putting 2a = 9.80 and 2a' = 0.202, it was first found that putting m = m' = 1.74⁵, fair agreement between the calculated and the observed values for intermediate values

of ϕ were obtained. Now the second term in equation (2) is, except when ϕ is nearly 90° , very small compared with the first term. One is therefore led to think that possibly it may represent nothing more than a spurious effect due to the crystalline non-uniformity of the samples; in fact, deviations of the axes at different points of the graphite strip of the order of 1° would suffice to explain such an apparent effect; the distribution of the current may also be non-unidirectional. It is hardly possible with the graphite specimens yet available to settle this point. If we may neglect the second term, we obtain the equation in polar coordinates

$$\frac{R' - R}{R} = \rho = 2a \cos^m \phi. \quad (3)$$

The curves in fig. 2 are drawn according to this equation, a being of course determined by experiment. The points indicated were experimentally determined. Curve IV. is the circle

$$\rho = 2a \cos \phi.$$

IV. Experiments at Low and High Temperatures.

In these experiments the cleavage plane of the specimen investigated was kept normal to the field. Observations were taken at temperatures of -179° , 0° , $+11^\circ$, $+95^\circ$, $+179^\circ$ C., the field being varied from 0 to 40 kgss. The methods of measurement were the same as those adopted for the measurements at ordinary temperatures; the determinations offered no difficulties, the resistances being quite steady. At the lower and higher temperatures thermo-electric effects were sometimes evident, but by successive reversals these were eliminated*. For the specimens G I. and IV. investigated an increase of resistance with temperature was found, the coefficient being of the high order of $+0.001$ per degree. The temperature curve ($\mathcal{H}=0$) $R/R_0 = \text{Funct}(\theta)$ is given in fig. 3 for specimen G I. 15; a similar curve (also shown) was obtained for G I. 11. Both show a strongly marked inflexion in the region of ordinary temperatures. It is interesting to compare these with one obtained by Kamerlingh Onnes and Clay †, which is for a bismuth spiral,

* It was incidentally observed that these thermo-electric effects—when occurring at the connexions of the graphite and therefore within the magnetic field—were influenced by the field. Thus in one case the thermo-electric effect was increased fourfold by a field of 26 kgss.

† H. Kamerlingh Onnes and J. Clay, *Versl. Kon. Akad. Wet. Amst.* xvi. p. 176 (1907). Cf. also W. Nernst and F. A. Lindemann, *Berl. Ber.* p. 306 (1911).

No. 301, by Hartmann and Braun, and extends to $-259^{\circ}\text{C}.$; this shows in the neighbourhood of -200° a weak extended inflexion; this curve is given in fig. 3, and is denoted by Bi.

Fig. 3.

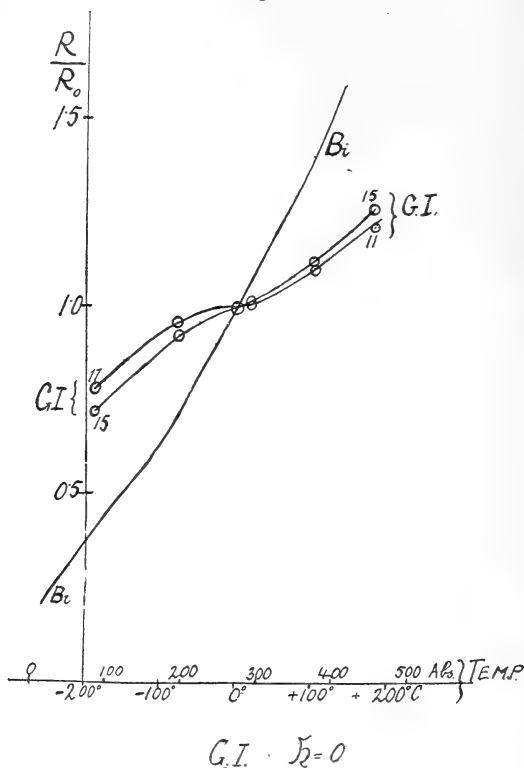

All the samples tested of the variety G I. behaved similarly although exhibiting appreciable quantitative differences, as is shown by the values of R_{18}/R_0 in Table I. Moreover, sometimes changes in R_{18} or R_0 were observed after the graphite had been subjected to extreme temperatures.

The temperature during a series of readings, the graphite being between the poles of the electromagnet, was determined as follows. Before commencing, the current required to be sent through the electromagnet in the reverse direction in order to reduce the residual field to zero was determined. Then, to measure the temperature, the graphite being in position, this reverse current was set up and the resistance of the graphite found. The temperature of the graphite

was then deduced from the temperature curve ($\mathfrak{H}=0$) fig. 3. Owing to the difficulty of exactly getting rid of the residual field without setting up a field in the opposite direction, and on account of the small change of resistance with temperature, this method of determining the temperature does not seem to be capable of great accuracy. The isothermals at low and high temperatures were determined for G I. 11 and G I. 15. Except for the difference in the magnitude of the changes of resistance concerned similar results were found. The results obtained with specimen G I. 15 are shown as

Fig. 4.

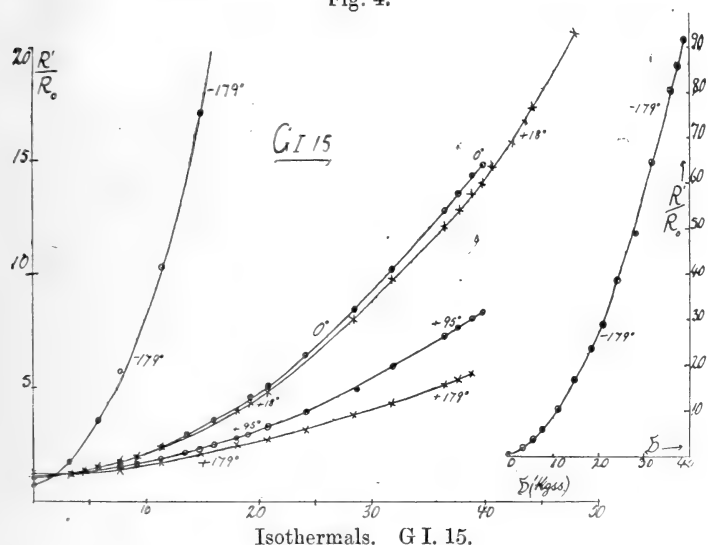

isothermal curves (fig. 4), from which the so-called isopedic curves ($\mathfrak{H}=\text{constant}$) may easily be deduced. As will be seen, the increase of resistance is much greater at low temperatures. At the temperature of liquid air the increase is 9300 per cent. for a field of 38.8 kilogauss, the increase at 18° C. in the same field being 1250 per cent.

The isothermal curves for the lower temperatures cannot be represented by an equation of the form (1): at higher temperatures this seems to be the case, although more accurate measurements appear desirable. I regret that owing to external circumstances I was unable to repeat the measurements at different temperatures, so that this section of the research can hardly be regarded as completed. As regards the practical application of the large effect here

found in graphite to the measurement of magnetic fields, it appears that the lack of definition and mechanical strength of this material would form serious objections. Also the resistance of a graphite piece is much less than that of a bismuth spiral. The chief disadvantage in the use of the latter lies in the difficulties of determining the temperature correction; the isothermals intersect one another; this, however, holds also in the case of graphite, as is seen by referring to fig. 4.

I beg, in conclusion, to express my gratitude to Prof. du Bois, in whose laboratory the experiments were carried out, for his constant advice and criticism, and for his kindness in placing the powerful du Bois electromagnet and other apparatus at my disposal. I am also indebted to Dr. W. J. de Haas for many valuable suggestions during the course of the investigation.

Bosscha-Laboratorium,
Berlin.
January 3rd, 1913.

VII. *On the Use of the Interferometer for the Study of Band Spectra.* By R. W. WOOD, *Professor of Experimental Physics, Johns Hopkins University**.

[Plate IV.]

IN a paper published in 1907 (*Phys. Zeit.* viii. p. 607) I drew attention to peculiar geometrical arrangements of the Fabry and Perot interference fringes exhibited in photographs of the titanium spectrum made by Dr. Pfund. As I showed in this paper, the existence of a symmetrical pattern in such a photograph indicated that the lines were spaced according to some mathematical law, and I suggested that in this way regularities might be found in very complicated line spectra.

The photograph in question was made by passing the light from the titanium arc through the half-silvered plates of a Fabry and Perot interferometer, and focussing an image of the circular ring system upon the slit of a grating spectrograph, the method being the one universally adopted for the determination of wave-lengths by interference methods. Owing to the large difference of path between the interfering streams of light, the order of the fringes changes by a considerable number as we pass from one line to the next, even in the case of lines lying very close together. If the

* Communicated by the Author.

spacing of the lines in the spectrum is fortuitous, the fringes, which break each line up into a vertical row of dots, cannot possibly form collectively a symmetrical pattern. Curved patterns were, however, seen in portions of the spectrum, which indicated a definite law of spacing in the case of the line groups upon which the patterns appeared. It has been my intention, ever since this observation was made, to make a further study of the subject, but pressure of other work, in combination with the hope that someone else would clear the matter up, has caused me repeatedly to postpone a return to the problem.

During the past winter I have, however, taken up the matter again, and by studying the phenomenon in the case of band spectra, where there is present a known law of spacing, have reached a very definite conclusion as to the manner in which the symmetrical patterns are produced, and to what extent they may be used for the study of spectrum regularities.

The bright and dark bands which form the patterns appear to be of a type of interference fringes hitherto undescribed, though they are of the same nature as the shadow bands which appear when any simple periodic structure is viewed through a similar superposed structure. By their aid we can show periodic discontinuities in a spectrum which are beyond the resolving power of the spectroscope, just as we can be sure that a distant roof is tiled if shadow bands appear when it is viewed through the meshes of the fly-screen in the window, even though we cannot see the individual tiles.

The manner in which the bands are formed is as follows.

If we employ the crater of the carbon arc as our source of light and focus the image of the circular ring system formed by passing the light through a Fabry and Perot interferometer, upon the slit of a spectroscope, we find the continuous spectrum traversed by vertical dark arcs, convex towards the red end, which are the loci of wave-lengths refused transmission through the half-silvered plates of the interferometer. If the centre of the ring system is at the centre of the slit, the portions of the slit above and below the centre are illuminated by rays which have traversed the air-film between the plates in an oblique direction, and have in consequence a smaller path difference, the formula for the path difference being $e = 2T \cos \theta$, in which T is the thickness of the film, and θ the angle which the rays make with the normal.

As the plates of the interferometer are separated, the dark arcs become narrower and more numerous, until finally the

spectroscope is unable to resolve them. If now in addition to the continuous spectrum we have a bright-line spectrum, the lines will cut across the arcs as shown in fig. 1, the light being absent in the line at each point of intersection.

Fig. 1.

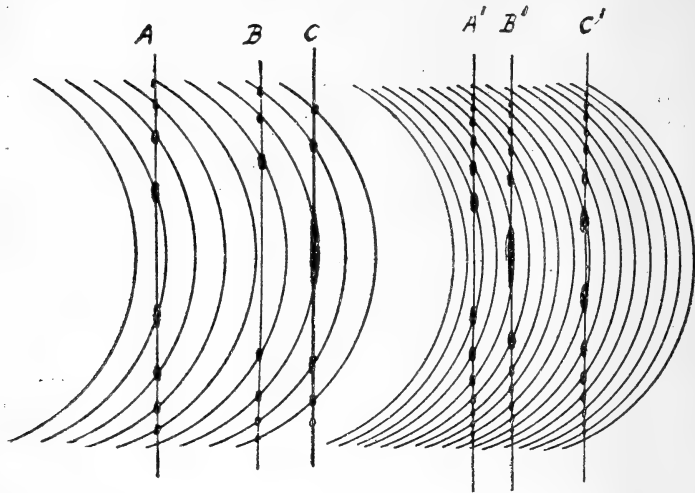

These dark spots in the spectrum lines are the cross-sections of the circular interference rings. In fig. 1 the spectrum line A is so placed in the spectrum, that with the given separation of the interferometer plates, four dark rings appear, the centre of the system being bright. Line C, however, shows a dark centre surrounded by three rings. Lines A', B', and C' show the state of things when the interferometer plates are separated by a thicker air-film, seven ring sections appearing in each line. This is merely another way of showing that the ring system becomes smaller as the plates are separated. (Lines A', B', C' are not supposed to be the same lines as A, B, C.)

On Plate IV. fig. 2 we have a photograph of the green and blue-green bands of the aluminium arc taken under the specified conditions, which shows patterns made up of closed curves of elliptical or circular form. These always appear when the head of the band is on the side of short wave-length. If the band points the other way, the patterns are made up of curves of hyperbola form, as is shown by Plate IV. fig. 1, a photograph of the band of the carbon arc having its head

at 5165. Lines which do not properly belong to the series forming the band produce kinks in the patterns, a conspicuous one being indicated by an arrow on fig. 1. A careful inspection of the figure shows also that the band is made up of two series of lines superposed; for we have a dark series of hyperbolæ, with a fainter series almost exactly out-of-step with the first. That these patterns show the presence of structure beyond the resolving power of the spectroscope employed to photograph them is clearly shown by fig. 2, for no trace of the lines forming the bands is shown in the vicinity of the "heads" in the narrow photograph of the aluminium spectrum taken with the same slit-width after the interferometer had been removed from the path of the light.

To ascertain the effect which the law governing the spacing of the lines had upon the appearance of the bands in the spectrum, I made a number of imitation spectra by ruling lines with a dividing-engine on the film of a photographic plate which had been fixed without exposure, the spacing of the lines being made to follow some definite law. These plates were then superposed on the photograph of the spectrum of a white source containing the dark arcs previously alluded to. The symmetrical bands at once appeared.

Two photographs of the superposed plates are reproduced on Plate IV. figs. 3 and 4, the former taken with the head of the series of lines towards the long wave-length end of the spectrum, the latter with the head turned the other way. In one case we have the hyperbolæ, and in the other the ellipses. The artificial series of lines appear alone at the top of each picture, the bands appearing only where they cut across the dark arcs formed in the continuous spectrum by the interference caused by the half-silvered plates.

A much more extended study of the subject will be necessary before the method can be of much use in the study of band and line spectra; and the object of the present paper is merely to draw attention to the possibilities of the method. I do not expect to continue the study of the subject myself, at least for the present; and it is my hope that other investigators will be able to develop the idea.

VIII. *The Flicker Photometer and the Iris.*

By H. C. STEVENS*.

IN a recent number of this Journal, the suggestion was made by an eminent authority † that the “physiological process” which affords the common basis by which coloured and uncoloured lights are measured by means of the flicker phenomenon, is the iris. The writer states that “The iris contracts when the eye is exposed to a bright red or to a bright green light. There must, therefore, be some relative brightness of the two lights which tends *equally* to close the iris, and this may afford the measure required. The flicker adjustment is complete when the iris has no tendency to alter under the alternating illumination.” And further, “It is clear, I think, that we have here a common element in variously coloured lights, such as might serve as the basis of coloured photometry.” It is undoubtedly true that the iris responds differently to lights of different intensities. Indeed, Haycraft ‡ has shown that the diameter of the pupil, as measured by instantaneous photograms, is a function of the intensity of the light falling upon the eye. The brightnesses of coloured lights determined by this method agree tolerably well with those obtained by the flicker photometer. It might well seem, therefore, that the iris were indeed the “physiological process” which serves as the common element in the measurement of intensities by the flicker photometer.

The hypothesis is susceptible of an experimental test such as to leave no doubt as to the rôle played by the iris in the flicker phenomenon. By the simple expedient of paralysing with atropin the *musculus sphincter pupillæ*, an iris is secured which is entirely immobile in the presence of lights of different intensities. Thus one is able by means of an *experimentum crucis* to eliminate from consideration the muscular action of the iris, according to the logical principle of the method of difference. If the flicker phenomenon persists in an eye with a paralysed iris, obviously some other physiological process must be sought as the cause of the phenomenon. Inasmuch as both irides react when light is thrown exclusively upon either eye, by virtue of the so-called consensual reaction of the irides, it is obvious that both eyes

* Communicated by the Author.

† Lord Rayleigh, ‘Coloured Photometry,’ vol. xxiv. no. 140, p. 301, Aug. 1912.

‡ Schaefer, ‘Text-book of Physiology,’ vol. ii. p. 1078.

must be atropinized in order to secure a condition which satisfies the logical requirements of the test.

The arrangements for producing flicker are shown in figure 1. The sources of light were two 16 candle-power

FIG. 1.

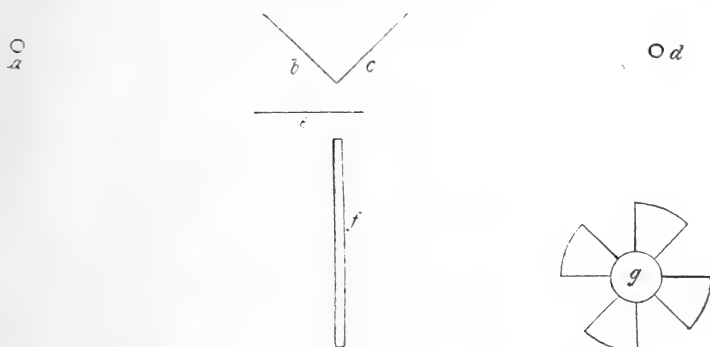

THE APPARATUS FOR PRODUCING FLICKER.

a and *d* are 16 c.-p. lamps on a 110 D. C. circuit.

b is dark blue coloured surface.

c is an orange coloured surface.

e is the card-board disk shown in *g*.

f is the tube through which the observations were made.

lamps, which are shown at *a* and *d* in the figure. The constancy of illumination of the lamps was controlled by a voltmeter in circuit with the lamps. The light from the lamps was reflected from the two oblique surfaces *b* and *c*. Surface *b* was coloured blue and surface *c* an orange. The sectored disk *g* was placed at *e*, where by its rotation it intercepted the light of the lamps which was reflected from surfaces *b* and *c*. The eye of the observer was placed at the end of the tube *f*, through which two flickering coloured surfaces, which divided the field of vision equally, appeared. Although the arrangement chosen for this experiment differed somewhat from those used in colour-photometry in that two flickering surfaces are shown in the field of vision, the arrangement was found very suitable for our experiment. By varying the speed of the motor, a series of flickers were produced which were arranged subjectively in a series from very coarse to fine, with the following designations: very coarse; coarse; medium; fine; and just visible. These designations proved to be very useful, since it was possible by means of them to compare the speed of rotation which caused a just noticeable flicker

or a coarse flicker for one observer with the speed of rotation of the disk, when a second observer described the flicker in the same terms as the first. The speed of the motor was regulated by means of a brake.

On January 18, 1913, an experiment was performed in which the irides of both eyes of the author and those of C. D. Livingstone were paralysed with a solution * of homatropine sulphate. When the pupil ceased to change in size with changing intensities of light, the observers observed the flickering fields through the tube of the apparatus with each eye separately and determined the rate of the motor which caused the flicker to disappear. In order to make sure that the reaction of the pupil to light was totally abolished so as not even to remain residually, the pupils of both eyes of both observers were tested, with the aid of a bi-convex lens which magnifies about two times, by S. Karrer, whose eyes were normal. No visible reaction remained in the eyes of either observer when tested before and after the experiment. Under these conditions, the appearance of the flicker was not changed in any observable particular from the appearance of the flicker to the normal eyes. All degrees of flicker remained as before the atropine was placed in the eyes, and it is to be noted also that the disagreeable quality of the coarse flicker persisted undiminished. To make certain that both observers were observing the same phenomenon, the rate of rotation of the disk which was necessary just to obliterate the flicker was determined for

TABLE I.

	H. C. S.	C. D. L.
Left eye.	9.8 rvs. per second or 39.2 flashes per second.	9.9 rvs. per second. 39.6 flashes per second.
Right eye.	10.4 rvs. per second or 41.6 flashes per second.	10.9 rvs. per second. 43.6 flashes per second.

each eye and for each observer. The results are shown in Table I. Both the number of revolutions of the disk per second and the number of flashes of light are given in the table.

* The prescription for the preparation is here given. As will be seen, the strength of the solution is somewhat less than 1 per cent.

Homatropinæ sulphatis i. gr. Aquæ Destillatæ ii. ʒ.

The agreement between the two eyes of each observer and between the two observers is as close as was to be expected from the method employed.

It should be pointed out that atropine, or its derivative homatropine, acts exclusively upon the myoneural junction of the nerve fibres which supply the sphincter muscle. The dilator muscle fibres, which have a nervous control totally different from that of the sphincter muscle fibres, are not affected by the atropine. The objection to the experiment just described, might be raised that the *musculus dilator pupillæ* might still respond to the light stimulus and so serve as the physiological process upon which flicker sensation depends. *A priori*, it is hardly conceivable that the dilator fibres could effect any change by themselves alone. The size of the normal pupil depends at any time upon the opposed action of the dilator and sphincter muscle fibres. When either muscle of the pair is paralysed, its opponent acts exclusively, with the result that a very large or very small pupil appears. But once the very large (mydriatic) pupil or its opposite condition the very small (myotic) pupil is achieved, there can be no change in the size of the pupil so long as the paralysis exists. The pupil is inactive in the presence of changing light intensities. The objection, therefore, is groundless.

University of Washington,
Seattle, Washington.

IX. *On the Energy required to Ionize an Atom.* By R. T. BEATY, M.A., D.Sc., Emmanuel College, Clerk Maxwell Student of the University, Cambridge*.

THE energy required to ionize an atom, that is, to detach an electron from an atom, is a quantity of importance in checking theories of atomic constitution. Let us suppose that we specify the constitution of an atom by assigning to it a central positive charge ne , surrounded by n electrons distributed in rings of known radii round the central charge. Then we can calculate the energy required to remove one of the electrons from the system.

It is now widely believed that the atom contains a central positive charge surrounded by a number of electrons equal to about half the atomic weight. Some of these electrons are supposed to be attached tightly to the central charge and to possess a vibration frequency much greater than that associated with light-waves. A few electrons are supposed

* Communicated by the Author.

to be disposed round the surface of the atom and to play a part in the refraction of light and in chemical processes.

Now the smaller the radii of the inner rings of electrons the less effect will they have in determining the energy required for ionization. Thus imagine a central charge $5e$ surrounded by a ring of radius b , containing four electrons, a fifth electron lying at a greater distance a from the centre, on a line joining the centre and one of the inner electrons.

The energy to remove the outer electron to infinity will be

$$\begin{aligned} W &= e^2 \left[\frac{5}{a} - \frac{1}{a-b} - \frac{1}{a+b} - \frac{2}{\sqrt{a^2+b^2}} \right] \\ &= \frac{e^2}{a} \left[1 - \frac{b^2}{a^2} \right] \end{aligned}$$

neglecting higher powers of $\frac{b}{a}$ than the second. If the four inner electrons were removed along with four units of the central charge, the energy for ionization would be

$$W = \frac{e^2}{a}.$$

Hence if $b = \frac{a}{10}$, the error produced by regarding the atom as simplified in this way would be 1 per cent.

If the central charge were $9e$, with eight electrons in the inner ring and one electron at ten times the distance from the centre, we find

$$W = \frac{e^2}{a} [1 - 0.039].$$

In this case if we regard the atom as consisting of a charge $+e$, with only one electron

$$W = \frac{e^2}{a},$$

so that the error introduced by the assumption is 4 per cent.

Hence a knowledge of the number of electrons in the outer ring and of the atomic radius should enable us to give an approximation to the energy required for ionization.

Values of the atomic radii have been given for the gases of the helium group* and for mercury vapour †.

The value for mercury, however, is not reliable ‡.

The results for the helium group were obtained under the

* Rankine, Proc. Roy. Soc. A. lxxxiii. p. 524.

† Koch, Wied. Ann. xix. p. 857.

‡ See Meyer, 'Kinetic Theory of Gases,' pp. 197-296.

same conditions and with the same apparatus, so that the relative values should have a high degree of accuracy.

From the fact that the α -particle on acquiring two electrons becomes an atom of helium, and from the many experimental results which agree with the conception that the number of electrons in the molecule is about half the molecular weight, we may conclude that the helium atom contains two electrons only. This view is further supported by Bohr's* deductions concerning the absorption of α -particles in matter.

From the chemical similarity of the gases of the helium group we may venture to assume that in each case two electrons only are present in the outer ring, the remainder forming rings with such small radii that their effect on the energy required to remove one of the outer electrons is balanced by a portion $(n-2)e$ of the charge of the positive nucleus.

Accordingly, for our purposes the atoms of the inert gases can all be represented by a central charge $2e$, and two electrons at opposite ends of a diameter, $2a$.

The energy required to remove one of these electrons from the atom is given by

$$2e \cdot \frac{e}{a} - e \cdot \frac{e}{2a} = 1.5 \cdot \frac{e^2}{a}.$$

This corresponds with the energy acquired by falling through a difference of potential E , if

$$Ee = 1.5 \frac{e^2}{a} \dots \dots \dots (1)$$

The value of the atomic radius of helium is given by Jeans ('Dynamical Theory of Gases,' p. 340) as $\cdot 90 \times 10^{-8}$; where Avogadro's number has been taken as 4×10^{19} . On using the value 2.75×10^{19} deduced by Rutherford, which agrees well with Planck's value 2.75×10^{19} , we get 1.09×10^{-8} for the atomic radius of helium.

	Relative Radii.	Absolute Radii.	E in volts.	
			Calculated.	Observed.
He	1	1.09×10^{-8}	19.4	20.5
Ne	1.19	1.298	16.3	16
A	1.68	1.83	11.6	12
Kr	1.91	2.08	10.15	—
Xe	2.25	2.45	8.65	—

The numbers in the second column are the ratios of the

* Bohr, Phil. Mag. January 1913, pp. 10-31.

atomic radii as given by Rankine*: the absolute values are given in the third column using Jeans's corrected value for helium. The values of E , the ionization potential, calculated from (1), are given in the fourth column.

A check upon these results is afforded by some recent experiments made by Franck and Hertz† upon the ionization potential in various gases.

If a corpuscle fall freely through a difference of potential E it will acquire energy Ee , which may be transferred to one of the electrons of an atom when a collision takes place between atom and corpuscle. If the energy be just sufficient to detach this electron from the atom, then E may be called the ionizing potential. The source of the corpuscles in the experiments of Franck and Hertz was a glowing platinum wire. They were accelerated by an electric field which was increased till positive ions were produced from the surrounding gas, showing that ionization had taken place.

The value of E found by Franck and Hertz for helium, neon, and argon are given in the fifth column of the table. The agreement with the calculated values is remarkably close.

Observations of the ionization potential for krypton and xenon would be of interest in this connexion, and it is to be hoped that such will be forthcoming.

Cavendish Laboratory, Cambridge.

X. *A Note on the Ballistic Galvanometer.* By T. J. I'A. BROMWICH, *Sc.D., F.R.S., St. John's College, Cambridge* ‡.

IN discussing the mathematical theory of the oscillations of the needle in a ballistic galvanometer, Maxwell treated the problem in two parts: he first § neglected the effect of damping and then obtained a formula which may be written

$$Q = (2H/Gp) \sin \frac{1}{2}\alpha, \dots \dots \dots (A)$$

where $2\pi/p$ is the complete period of oscillation of the needle, and α is the angle of swing produced by passing a quantity of electricity Q round the coil of the galvanometer.

Secondly ||, Maxwell treated the case in which the angle of swing is small enough for $\sin \theta$ to be replaced by θ ; and

* Rankine, *loc. cit.*

† Franck and Hertz, *Berichte d. D. P. Gesellschaft*, ii. pp. 34-45 (1913).

‡ Communicated by Sir J. J. Thomson, O.M., F.R.S.

§ 'Electricity and Magnetism,' vol. ii. Art. 748.

|| *L. c.* Art. 749.

then, allowing for damping, a formula is obtained which in the case of slight damping reduces to

$$Q = (H/Gp)(1 + \frac{1}{2}\lambda)\alpha, \quad (B)$$

λ being the logarithmic decrement of the oscillating needle.

Now if the discharge Q is large enough to necessitate the use of $\sin \frac{1}{2}\alpha$ in place of $\frac{1}{2}\alpha$, and if at the same time the effect of damping is needed, it is natural to conjecture that the formula might be taken as

$$Q = (2H/Gp)(1 + \frac{1}{2}\lambda) \sin \frac{1}{2}\alpha, \quad . . . (C)$$

derived by a sort of superposition of (A), (B). Actually the formula (C) is sometimes quoted in books on Physics as given by Maxwell; but the formula is not to be found in the articles mentioned above.

The question now suggests itself:—To what extent is (C) correct, and how can the formula be improved?

This question is answered below; as might be expected, (C) is not exact, but is a good approximation so long as α is not too large. The more exact formula will be found in (9); and a glance at the table will indicate the necessary correction to (C).

Approximate Theory of the Ballistic Galvanometer.

Suppose that in a *small* oscillation of the needle it is found that the period is T and that the logarithmic decrement is λ ; then in the small oscillations the equation of motion is

$$\frac{d^2\theta}{dt^2} + 2\rho \frac{d\theta}{dt} + (p^2 + \rho^2)\theta = 0, \quad . . . (1)$$

where $T = 2\pi/p$ and $\lambda = \frac{1}{2}\rho T = \pi\rho/p$.

If now the oscillation is of larger amplitude, the equation of motion will be

$$\frac{d^2\theta}{dt^2} + 2\rho \frac{d\theta}{dt} + (p^2 + \rho^2) \sin \theta = 0, \quad . . . (2)$$

instead of (1); multiply this equation (2) by $d\theta/dt$ and integrate from the position of equilibrium ($\theta = 0$) over part of the first swing of the needle. We then find

$$\frac{1}{2} \left(\frac{d\theta}{dt} \right)^2 + 2\rho \int \left(\frac{d\theta}{dt} \right)^2 dt + (p^2 + \rho^2)(1 - \cos \theta) = \frac{1}{2}\omega^2, \quad (3)$$

if ω is the initial angular velocity of the needle, produced by passing the amount Q of electricity round the coil.

The actual observation which can be made on the needle will give the value $\theta = \alpha$ at which the needle first comes to rest; so that we can find ω by putting $\theta = \alpha$ in (3), which gives

$$\omega^2 = 4(\rho^2 + \rho'^2) \sin^2 \frac{1}{2}\alpha + 4\rho \int \left(\frac{d\theta}{dt}\right)^2 dt, \quad \dots \quad (4)$$

the integral extending over the time of swing from $\theta = 0$ to $\theta = \alpha$.

It appears to be impossible to evaluate the integral in (4) exactly; but an approximate solution is easily found when ρ is small enough to allow ρ'^2 to be neglected. On this hypothesis, we may neglect ρ entirely when calculating the integral, because in (4) the integral is multiplied by ρ ; thus, in finding the integral, we replace (3) by the approximation

$$\left(\frac{d\theta}{dt}\right)^2 = 4\rho^2(\sin^2 \frac{1}{2}\alpha - \sin^2 \frac{1}{2}\theta)$$

$$\text{or} \quad \left. \begin{aligned} \frac{d\theta}{dt} &= 2\rho \sin \frac{1}{2}\alpha \cos \phi \\ \text{where} \quad \sin \frac{1}{2}\theta &= \sin \frac{1}{2}\alpha \sin \phi \end{aligned} \right\}, \quad \dots \quad (5)$$

and then the swing from $\theta = 0$ to α corresponds to a range in ϕ from 0 to $\frac{1}{2}\pi$.

Thus we may write in (4)

$$\int \left(\frac{d\theta}{dt}\right)^2 dt = \int_0^\alpha \frac{d\theta}{dt} d\theta = 4\rho \sin^2 \frac{1}{2}\alpha \int_0^{\frac{1}{2}\pi} \frac{\cos^2 \phi d\phi}{\sqrt{(1 - \sin^2 \frac{1}{2}\alpha \sin^2 \phi)}}.$$

It is easy to express the last integral in terms of the complete elliptic integrals K, E to modulus $k = \sin \frac{1}{2}\alpha$: in fact we have

$$\int_0^{\frac{1}{2}\pi} \frac{k^2 \cos^2 \phi d\phi}{\sqrt{(1 - k^2 \sin^2 \phi)}} = E - (1 - k^2)K. \quad \dots \quad (6)$$

But if α does not exceed 60° , the value of k^2 will not exceed $\frac{1}{4}$, and then a series will be usually simpler to work with; thus expanding the denominator by the binomial theorem and integrating term-by-term we find

$$\left. \begin{aligned} \int_0^{\frac{1}{2}\pi} \frac{\cos^2 \phi d\phi}{\sqrt{(1 - k^2 \sin^2 \phi)}} &= \frac{\pi}{4} \sigma \\ \text{where} \quad \sigma &= 1 + \frac{1^2}{2 \cdot 4} k^2 + \frac{1^2 \cdot 3^2}{2 \cdot 4^2 \cdot 6} k^4 + \frac{1^2 \cdot 3^2 \cdot 5^2}{2 \cdot 4^2 \cdot 6^2 \cdot 8} k^6 + \dots \end{aligned} \right\} \quad (7)$$

It is easy to see that when α does not exceed 60° the series for σ in (7) can be calculated to an accuracy of one per cent. by retaining only the first and second terms: and this will suffice for most cases of interest. For large values of α , it is better to use the tables for K , E and to write

$$\sigma = (4/\pi) \{E - (1 - k^2)K\} / k^2. \quad \dots \quad (7a)$$

We have now the approximation

$$\int \left(\frac{d\theta}{dt}\right)^2 dt = \int_0^\alpha \frac{d\theta}{dt} d\theta = \pi p \sigma \sin^2 \frac{1}{2}\alpha$$

and so (4) yields the result (neglecting ρ^2)

$$\omega^2 = 4p^2 \sin^2 \frac{1}{2}\alpha + 4\pi\rho p \sigma \sin^2 \frac{1}{2}\alpha.$$

Thus

$$\omega = 2p \sin \frac{1}{2}\alpha \left(1 + \frac{1}{2}\lambda\sigma\right) \} \quad \dots \quad (8)$$

where

$$\lambda = \pi\rho/p.$$

The investigation given by Maxwell shows that the value of Q is connected with that of ω by the equation

$$I\omega = GQ,$$

where G is the galvanometer constant and I is the moment of inertia of the needle. Also, if H is the horizontal component of the earth's field

$$I(p^2 + \rho^2) = H;$$

and so neglecting ρ^2 , in agreement with our former work, we find the relation

$$H\omega = G\rho^2 Q.$$

Hence from (8) we have the formula required to improve (C), namely

$$\left. \begin{aligned} Q &= \frac{2H}{Gp} \sin \frac{1}{2}\alpha \left(1 + \frac{1}{2}\lambda\sigma\right) \\ \text{where } \sigma &= 1 + \frac{1^2}{2 \cdot 4} k^2 + \frac{1^2 \cdot 3^2}{2 \cdot 4^2 \cdot 6} k^4 + \dots \\ &= \frac{4}{\pi k^2} \left\{ E - (1 - k^2)K \right\} \end{aligned} \right\} \quad \dots \quad (9)$$

k being $\sin \frac{1}{2}\alpha$.

The following table gives the values of the factor σ ; for

values of α less than 60° the series was used, and for the remainder the tables of elliptic integrals:—

α .	σ .	α .	σ .
10°.....	1.001	100°.....	1.098
20	1.004	110	1.118
30	1.009	120	1.141
40	1.015	130	1.165
50	1.024	140	1.190
60	1.035	150	1.216
70	1.047	160	1.241
80	1.062	170	1.261
90	1.079	180	1.273

Corresponding to $\alpha = \pi$, it is easy to see directly from the integral (7) that (putting $k=1$)

$$\sigma = \frac{4}{\pi} \int_0^{\frac{1}{2}\pi} \cos \phi \, d\phi = \frac{4}{\pi} = 1.2732.$$

XI. *Interference Phenomena with Gamma Rays.* By A. NORMAN SHAW, M.Sc., 1851 Exhibition Scholar of McGill University, Montreal; Research Student of Gonville and Caius College, Cambridge*.

[Plate V.]

RECENT experiments by Friedrich, Knipping, and Laue † and many other investigators, have shown that Röntgen rays can exhibit phenomena analogous to the interference of light. As the intervals of a diffraction grating must be approximately of the same order of magnitude as the wavelengths to be examined, it had hitherto been impossible to obtain a grating fine enough to affect a beam of Röntgen rays. Laue, however, found that the regular arrangement of the atoms or molecules in crystals provided a grating in three dimensions which was suitable for affecting waves of the order 10^{-8} to 10^{-9} cm. in length. It was thought desirable to test the effect of such a grating or space-lattice on a beam of γ rays.

In attempting to apply Laue's methods to the case of γ rays, two difficulties appeared. (1) The ordinary secondary effects were much more intense than for X-rays, with the result that the consequent fogging of the photographic

* Communicated by Professor Sir J. J. Thomson, O.M., F.R.S.

† Laue, *Sitzungsber. der Kön. Bayerischen Akad. der Wiss.* p. 303, June, and p. 363, July 1912.

plate tended to render the presence of possible "spots" indeterminable. (2) If the direct β rays were eliminated, an exposure of over an hour was necessary in order to produce the faintest impression on a photographic plate with a beam of γ rays three millimetres in diameter, the source being so arranged that the beam was produced by about fifteen milligrams of radium bromide. This meant that an exposure of many weeks would be required in order to obtain the desired "spots," and in acting over such an extended period the first difficulty tended to become insuperable.

W. L. Bragg* has shown that the spots in the interference patterns obtained by Laue can be treated as though they were formed by reflexion of the incident beam at planes which are packed with atoms (or molecules) deviating from the planes by distances that are small compared with atomic dimensions. He found that the reflexion of Röntgen rays from crystals containing very marked cleavage-planes illustrated the phenomenon much more readily. It required only a short exposure in order to get the reflected spot, while in the case of the complete pattern, exposures of many hours were necessary. It was at first assumed that if the phenomenon existed for γ rays, it would likewise be easier to detect their reflexion from the main cleavage-planes. Experiments, however, showed that this was not the case, but actual results were obtained which suggested an interesting explanation upon comparison with X-ray photographs taken under similar conditions.

Fig. 1.

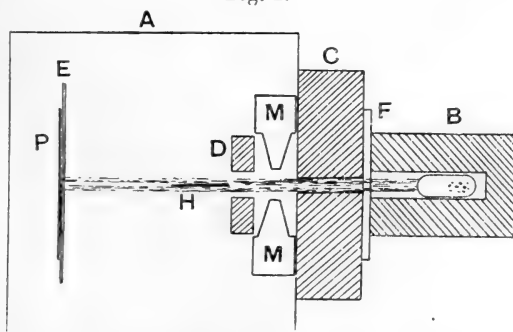

†† A diagram of the experimental arrangement is shown in fig. 1. The "source" is contained in a lead cylinder B, and

* W. L. Bragg, *Camb. Phil. Soc.* vol. xvii. p. 43 (1913), and *Science Progress*, vol. vii. No. 27, p. 372 (1913).

a definite beam is obtained through two holes in thick lead blocks C and D, the opening in D being always larger than that in C. F is a plate of lead about 2 mm. thick which was used to cut off the direct β rays, and MM represent the pole-pieces by means of which the secondary "emergence" β radiation from F is deflected as much as possible from the hole in D. H represents a plate of mica at right angles to the plane of the figure and arranged at almost grazing incidence (or actually in the direction of the beam). The photographic plate is represented by P, in contact with which layers of paper E, or paper and thin metal foil, could be placed. The photographic part was enclosed in a light-proof box, A.

It was found that the sensitiveness to γ rays was increased by placing the thin layers of matter in front of, and almost in contact with, the photographic plate. More β particles were thus liberated in the path of any beam of γ rays near the surface of the plate, and the impression was intensified without an appreciable amount of additional scattering.

In the experiments recorded below the exposures varied in length from eight hundred to fifteen hundred times the time necessary for the production of a visible spot by the direct rays. Figures 2, 3, and 4 (see Pl. V.) are drawings of three photographs which indicated the interference phenomena for γ rays. The intensity of the markings has been considerably exaggerated; in the actual photograph the effects were very faint, although quite definite, and there was considerable fogging due to penetration of some of the γ radiation through the lead.

In the case of the result shown in fig. 2, a sheet of mica about 3 cm. square and 0.3 mm. thick was placed at almost grazing incidence. The hole in C was 1 mm. in diameter, and the plate P was about 5 cm. from the mica. The sensitiveness was such that an exposure of 40 minutes to the direct beam was necessary to produce an impression on the plate. An exposure of one month was taken for this photograph, and any rays down to $\frac{1}{1100}$ of the intensity of the main beam were thus detectable.

In the case of fig. 3 a sheet of mica 1 mm. thick was used at complete grazing incidence. The distance of the plate from the mica was 15 cm. and the hole in C was 2 mm. in diameter. An exposure of one month was taken, which in this case was found sufficient to detect rays down to about $\frac{1}{1500}$ the intensity of the direct beam.

The result in fig. 4 was produced with thicker mica (about

3.5 mm.) at almost grazing incidence, the photographic plate was only 2 cm. from the mica, and the hole in C was 8 mm. in diameter. With this aperture much more radioactive material lay in the path of the beam, and a faint impression from a direct beam could be obtained with between five and ten minutes exposure. An exposure of five days was taken.

Three other photographs were taken with the mica deviating from grazing incidence by about five degrees, but no effects were obtained at this angle.

As the β radiation could not be entirely prevented from reaching the plate, two photographs were taken in which the β rays had only to traverse one millimetre of glass in the path of the beam. No intensification of the "spots" was obtained, and it was assumed that the γ rays were responsible for the markings in figs. 2, 3, and 4.

In fig. 5 the result was produced by hard X-rays under the same general experimental conditions as in fig. 3, the mica, however, deviating slightly from grazing incidence. Mr. W. L. Bragg kindly showed the writer several interesting photographs which also illustrated the same type of arrangement, in certain cases the reflexions from the main cleavage-planes being less intense than from other planes at greatly inclined angles.

The intensity of the "spots" apparently depends on the number of molecules in a reflecting plane, but more especially on the distance between the planes considered and on the wave-length of the incident radiation. In the case of the soft X-rays used for the reflexion photographs obtained by W. L. Bragg with mica, the distance between the main cleavage-planes apparently bears such a proportion to the wave-length of the rays that the main reflected spot is of much greater intensity than any of those reflected from other planes. If, however, very hard X-rays are used, other spots spring into much greater prominence than the one reflected from the cleavage-planes. In this case the chief reflecting planes are closer together but must each have fewer molecules, hence it appears that the distance between the planes must be the more important factor in the determination of the intensity of reflexion for a given wave-length.

An examination of the photographs shows that the effects with γ rays are obtained in one of the directions in which the more intense spots were obtained with hard X-rays. The distances between the markings in the different cases are approximately proportional to the distance of the plate from the mica.

Since it is thus apparent that we get faint effects with γ rays in those directions in which very hard X-rays give their most intense reflexions, and no perceptible effect in the direction in which soft X-rays give their strongest reflexion, we may conclude that the wave-length of the soft γ rays from radium is less than that of hard X-rays by an amount not differing greatly from the difference in wave-length between the softest and the hardest X-rays that can be produced with an ordinary bulb and coil.

This agrees with an approximate estimation which may be based on a theory of Planck. If we assume that the conclusions with regard to the relation between the velocity of emission of electrons from surfaces and the frequency of the ultra-violet light causing them * can be extended to the case of X-rays † and also to that of γ rays, then it follows from Planck's expression, $\frac{1}{2}mv^2 = hn$ (where m is the mass of the electron, v its maximum velocity, h is Planck's unit and n is the frequency of the incident radiation) that

$$\frac{V_1^2}{V_2^2} = \frac{\lambda_2}{\lambda_1},$$

where V_1 is the maximum velocity of secondary corpuscular radiation when X-rays fall on a given substance, V_2 their maximum velocity when γ rays fall on the substance, λ_1 is the wave-length of the X-rays and λ_2 that of the γ rays. Experimental data for the velocities of secondary corpuscular radiations under similar conditions for the two types of incident radiation are not available, but a substitution of approximate values at once shows that ordinary γ rays from radium have on these assumptions wave-lengths probably about ten, or at the most a hundred times smaller than the wave-length of the hardest Röntgen radiations.

The experiments are being continued, and it is hoped that further data will be obtained with other crystals. In conclusion the writer desires to thank Professor Sir J. J. Thomson for his kind interest in the work.

The Cavendish Laboratory,
May 17, 1913.

* A. L. Hughes, *Phil. Trans. A.* vol. cccii. p. 205 (1912).

† Barkla, *Phil. Mag.* vol. xxv. p. 298 (1913).

XII. *On the Approximate Solution of certain Problems relating to the Potential.*—II. By Lord RAYLEIGH, O.M., F.R.S.*

THE present paper may be regarded as supplementary to one with the same title published a long while ago †. In two dimensions, if ϕ , ψ be potential and stream-functions, and if (*e. g.*) ψ be zero along the line $y=0$, we may take

$$\phi = \int f dx - \frac{y^2}{1.2} f' + \frac{y^4}{1.2.3.4} f''' - \dots \quad (1)$$

$$\psi = yf - \frac{y^3}{1.2.3} f'' + \frac{y^5}{1.2.3.4.5} f^{iv} - \dots \quad (2)$$

f being a function of x so far arbitrary. These values satisfy the general conditions for the potential and stream-functions, and when $y = 0$ make

$$d\phi/dx = f, \quad \psi = 0.$$

Equation (2) may be regarded as determining the lines of flow (any one of which may be supposed to be the boundary) in terms of f . Conversely, if y be supposed known as a function of x and ψ be constant (say unity), we may find f by successive approximation. Thus

$$f = \frac{1}{y} + \frac{y^2}{6} \frac{d^2}{dx^2} \left(\frac{1}{y} \right) + \frac{y^2}{36} \frac{d^2}{dx^2} \left\{ y^2 \frac{d^2}{dx^2} \left(\frac{1}{y} \right) \right\} - \frac{y^4}{120} \frac{d^4}{dx^4} \left(\frac{1}{y} \right). \quad (3)$$

We may use these equations to investigate the stream-lines for which ψ has a value intermediate between 0 and 1. If η denote the corresponding value of y , we have to eliminate f between

$$1 = yf - \frac{y^3}{6} f'' + \frac{y^5}{120} f^{iv} - \dots,$$

$$\psi = \eta f - \frac{\eta^3}{6} f'' + \frac{\eta^5}{120} f^{iv} - \dots;$$

whence

$$\eta = \psi y + \frac{f''}{6} (y\eta^3 - \eta y^3) - \frac{f^{iv}}{120} (y\eta^5 - \eta y^5),$$

* Communicated by the Author.

† Proc. Lond. Math. Soc. vii. p. 75 (1876); Scientific Papers, vol. i. p. 272.

or by use of (3)

$$\eta = \psi y + \frac{y^4(\psi^3 - \psi)}{6} \frac{d^2}{dx^2} \left(\frac{1}{y} \right) + \frac{y^7(\psi^2 - 1)(3\psi^2 - \psi)}{36} \left\{ \frac{d^2}{dx^2} \left(\frac{1}{y} \right) \right\}^2 + \frac{y^4(\psi^3 - \psi)}{36} \frac{d^2}{dx^2} \left\{ y^2 \frac{d^2}{dx^2} \left(\frac{1}{y} \right) \right\} - \frac{y^6(\psi^5 - \psi)}{120} \frac{d^4}{dx^4} \left(\frac{1}{y} \right). \quad (4)$$

The evanescence of ψ when $y=0$ may arise from this axis being itself a boundary, or from the second boundary being a symmetrical curve situated upon the other side of the axis. In the former paper expressions for the "resistance" and "conductivity" were developed.

We will now suppose that $\psi=0$ along a circle of radius a , in substitution for the axis of x . Taking polar coordinates $a+r$ and θ , we have as the general equation

$$(a+r)^2 \frac{d^2\psi}{dr^2} + (a+r) \frac{d\psi}{dr} + \frac{d^2\psi}{d\theta^2} = 0. \quad (5)$$

Assuming

$$\psi = R_1 r + R_2 r^2 + R_3 r^3 + \dots, \quad (6)$$

where $R_1, R_2, \&c.$, are functions of θ , we find on substitution in (5)

$$\left. \begin{aligned} 2a^2 R_2 + a R_1 &= 0, \\ 6a^2 R_3 + 6a R_2 + R_1 + R_1'' &= 0; \end{aligned} \right\} \quad (7)$$

so that

$$\psi = R_1 r - \frac{R_1 r^2}{2a} + \frac{(2R_1 - R_1'') r^3}{6a^2} \quad (8)$$

is the form corresponding to (2) above.

If $\psi = 1$, (8) yields

$$R_1 = \frac{1}{r} + \frac{1}{2a} - \frac{r}{12a^2} + \frac{r^2}{6a^2} \frac{d^2}{d\theta^2} \left(\frac{1}{r} \right), \quad (9)$$

expressing R_1 as a function of θ , when r is known as such. To interpolate a curve for which ρ takes the place of r , we have to eliminate R_1 between

$$1 = R_1 r - \frac{R_1 r^2}{2a} + \frac{(2R_1 - R_1'') r^2}{6a^2},$$

$$\psi = R_1 \rho - \frac{R_1 \rho^2}{2a} + \frac{(2R_1 - R_1'') \rho^2}{6a^2}.$$

Thus

$$\rho = r\psi - \frac{R_1}{2a} (\rho r^2 - r\rho^2) + \frac{2R_1 - R_1''}{6a^2} (\rho r^3 - r\rho^3),$$

and by successive approximation with use of (9)

$$\begin{aligned} \rho = r\psi + \frac{r^2}{a} \frac{\psi(\psi - 1)}{1.2} + \frac{r^3}{a^2} \frac{\psi(\psi - 1)(\psi - 2)}{1.2.3} \\ + \frac{r^4}{a^2} \frac{\psi(\psi^2 - 1)}{6} \frac{d^2}{d\theta^2} \left(\frac{1}{r} \right). \quad \dots \dots \dots (10) \end{aligned}$$

The significance of the first three terms is brought out if we suppose that r is constant (α), so that the last term vanishes. In this case the exact solution is

$$\log \frac{a + \rho}{a} = \psi \log \frac{a + \alpha}{a}, \quad \dots \dots (11)$$

whence

$$\begin{aligned} \frac{\rho}{a} = \left(\frac{a + \alpha}{a} \right)^\psi - 1 = \psi \frac{\alpha}{a} + \frac{\psi(\psi - 1)}{1.2} \frac{\alpha^2}{a^2} \\ + \frac{\psi(\psi - 1)(\psi - 2)}{1.2.3} \frac{\alpha^3}{a^3} + \dots \dots \dots (12) \end{aligned}$$

in agreement with (10).

In the above investigation ψ is supposed to be zero exactly upon the circle of radius a . If the circle whose centre is taken as origin of coordinates be merely the circle of curvature of the curve $\psi = 0$ at the point ($\theta = 0$) under consideration, ψ will not vanish exactly upon it, but only when r has the approximate value $c\theta^3$, c being a constant. In (6) an initial term R_0 must be introduced, whose approximate value is $-c\theta^3 R_1$. But since R_0'' vanishes with θ , equation (7) and its consequences remain undisturbed and (10) is still available as a formula of interpolation. In all these cases, the success of the approximation depends of course upon the degree of slowness with which y , or r varies.

Another form of the problem arises when what is given is not a pair of neighbouring curves along each of which (*e. g.*) the stream-function is constant, but *one* such curve together with the variation of potential along it. It is then required to construct a neighbouring stream-line and to

determine the distribution of potential upon it, from which again a fresh departure may be made if desired. For this purpose we regard the rectangular coordinates x , y as functions of ξ (potential) and η (stream-function), so that

$$x + iy = f(\xi + i\eta), \quad \quad (13)$$

in which we are supposed to know $f(\xi)$ corresponding to $\eta = 0$, *i. e.*, x and y are there known functions of ξ . Take a point on $\eta = 0$, at which without loss of generality ξ may be supposed also to vanish, and form the expressions for x and y in the neighbourhood. From

$$x + iy = A_0 + iB_0 + (A_1 + iB_1)(\xi + i\eta) \\ + (A_2 + iB_2)(\xi + i\eta)^2 + \dots,$$

we derive

$$x = A_0 + A_1\xi - B_1\eta + A_2(\xi^2 - \eta^2) - 2B_2\xi\eta \\ + A_3(\xi^3 - 3\xi\eta^2) - B_3(3\xi^2\eta - \eta^3) \\ + A_4(\xi^4 - 6\xi^2\eta^2 + \eta^4) - 4B_4(\xi^3\eta - \xi\eta^3) + \dots, \\ y = B_0 + B_1\xi + A_1\eta + 2A_2\xi\eta + B_2(\xi^2 - \eta^2) \\ + A_3(3\xi^2\eta - \eta^3) + B_3(\xi^3 - 3\xi\eta^2) \\ + 4A_4(\xi^3\eta - \xi\eta^3) + B_4(\xi^4 - 6\xi^2\eta^2 + \eta^4) + \dots$$

When $\eta = 0$,

$$x = A_0 + A_1\xi + A_2\xi^2 + A_3\xi^3 + A_4\xi^4 + \dots \\ y = B_0 + B_1\xi + B_2\xi^2 + B_3\xi^3 + B_4\xi^4 + \dots$$

Since x and y are known as functions of ξ when $\eta = 0$, these equations determine the A's and the B's, and the general values of x and y follow. When $\xi = 0$, but η undergoes an increment,

$$x = A_0 - B_1\eta - A_2\eta^2 + B_3\eta^3 + A_4\eta^4 - \dots, \quad (14)$$

$$y = B_0 + A_1\eta - B_2\eta^2 - A_3\eta^3 + B_4\eta^4 + \dots, \quad (15)$$

in which we may suppose $\eta = 1$.

The A's and B's are readily determined if we know the values of x and y for $\eta = 0$ and for equidistant values of ξ , say $\xi = 0$, $\xi = \pm 1$, $\xi = \pm 2$. Thus, if the values of x be

called $x_0, x_{-1}, x_1, x_2, x_{-2}$, we find

$$A_0 = x_0, \quad \text{and}$$

$$A_1 = \frac{2}{3}(x_1 - x_{-1}) - \frac{1}{12}(x_2 - x_{-2}), \quad A_3 = \frac{x_2 - x_{-2}}{12} - \frac{x_1 - x_{-1}}{6},$$

$$A_2 = \frac{2(x_1 + x_{-1} - 2x_0)}{3} - \frac{x_2 + x_{-2} - 2x_0}{24},$$

$$A_4 = \frac{x_2 + x_{-2} - 2x_0}{24} - \frac{x_1 + x_{-1} - 2x_0}{6}.$$

The B's are deduced from the A's by merely writing y for x throughout. Thus from (14) when $\xi = 0, \eta = 1$,

$$\begin{aligned} x = x_0 - \frac{5}{6}(x_1 + x_{-1} - 2x_0) + \frac{1}{12}(x_2 + x_{-2} - 2x_0) \\ - \frac{5}{6}(y_1 - y_{-1}) + \frac{1}{6}(y_2 - y_{-2}). \quad \dots \quad (16) \end{aligned}$$

Similarly

$$\begin{aligned} y = y_0 - \frac{5}{6}(y_1 + y_{-1} - 2y_0) + \frac{1}{12}(y_2 + y_{-2} - 2y_0) \\ + \frac{5}{6}(x_1 - x_{-1}) - \frac{1}{6}(x_2 - x_{-2}). \quad \dots \quad (17) \end{aligned}$$

By these formulæ a point is found upon a new stream-line ($\eta=1$) corresponding to a given value of ξ . And there would be no difficulty in carrying the approximation further if desired.

As an example of the kind of problem to which these results might be applied, suppose that by observation or otherwise we know the form of the upper stream-line constituting part of the free surface when liquid falls steadily over a two-dimensional weir. Since the velocity is known at every point of the free surface, we are in a position to determine ξ along this stream-line, and thus to apply the formulæ so as to find interior stream-lines in succession.

Again (with interchange of ξ and η) we could find what forms are admissible for the second coating of a two-dimensional condenser, in order that the charge upon the first coating, given in size and shape, may have a given value at every point.

XIII. *Self-Recording Electrometer.* By J. PATTERSON, M.A.,
*Physicist to the Meteorological Service of Canada**.

[Plate VI.]

Introduction.

BENNDORF † has designed an electrometer which gives a continuous record by mechanical registration, and the Cambridge Scientific Instrument Co. has a self-recording galvanometer on the same principle, called the thread-recorder. In the Benndorf instrument the apparatus for producing the registration is operated by an electromagnet worked by clockwork, while in the thread-recorder it is all done by clockwork. It occurred to the author that the recording mechanism of the thread-recorder could also be used for a self-recording electrometer as well as for a galvanometer.

In these instruments a boom with a counterpoise is attached to the axis of the needle, and the excursions of the end of the boom are registered at stated intervals by a bar dropping and nipping an inked thread or ribbon between the boom and the recording paper, thus leaving a dot, which gives the deflexion of the needle at the moment of registration. In this way all mechanical friction is avoided.

Preliminary Experiments.

Preliminary experiments were made by roughly constructing models of the electrometer in order to design the size of the quadrants, length of boom, &c., that would give the most delicate instrument, and at the same time be as compact as possible. Throughout this paper, "The sensitiveness of the instrument" refers to the openness of scale. An adjustable bifilar suspension of silver platinum wire was used in all the preliminary experiments. The quadrants were 5 in. in diameter and $\frac{1}{2}$ in. between the faces, and a needle of the Dolezalek type $4\frac{1}{2}$ in. in diameter was made of silvered mica. The needle was insulated from the boom and was damped by a platinum vane dipping in a jar of sulphuric acid, through which electrical connexion was made with the needle.

* Communicated by the Author. Read before the Royal Society of Canada, May 25, 1913.

† *Akad. Wiss. Wien, Sitzb. d. mathem.-naturw. Cl. Bd. cxi. Abth. IIa.* p. 487 (1902).

Booms suitably counterpoised, $9\frac{1}{2}$ in., $7\frac{1}{2}$ in., $6\frac{1}{2}$ in., and 6 in. long were tried in turn, the longest being used first, and then the next by cutting off a piece. Joining one pair of quadrants to the positive terminal of an 80 volt battery and the other to the negative, the centre of the battery being earthed, the booms gave a deflexion of 1 millimetre for a potential of 12·6, 8, 6, and 8·3 volts on the needle respectively. Needles $4\frac{1}{2}$ in., 4 in., $3\frac{1}{2}$ in., and 3 in. in diameter were also tried with the $6\frac{1}{2}$ in. and 6 in. booms. The faces of the quadrants were closer together for the smaller than for the larger needles, but the bifilar suspension was the same in all.

The results are given in Table I.

TABLE I.

Length of Boom.	Volts on needle per mm. deflexion with P.D. of 80 volts across quadrants.			
	$4\frac{1}{2}$ in. needle.	4 in. needle.	$3\frac{1}{2}$ in. needle.	3 in. needle.
$6\frac{1}{2}$ in.	6	8·6	10	20
6 in.....	8·3	10	12·1	16·6

Both sets of tests show that the $6\frac{1}{2}$ in. boom and the $4\frac{1}{2}$ in. needle give the best results. Owing to the crude construction of the instrument, however, it is not possible to make any further comparison.

If the vane is made as light as possible, the weight of the boom, its counterpoise and the attachment to the needle, is very much greater than that of the vane of the needle, so that the sensitiveness of the suspension cannot be altered appreciably for the smaller vanes; and thus we get the greater sensitiveness for the larger needles. Owing to the construction of the thread-recorder, it was not possible without greatly increasing the length of the boom to make the quadrants larger than would suit a $4\frac{1}{2}$ in. needle, so that larger needles were not tried.

These considerations suggested that if a second vane were added and doubled-celled quadrants used, the weight of the suspended system would not be appreciably altered, and the deflecting force on the needle would be doubled, thus almost doubling the sensitiveness of the instrument.

In testing this the results given in Table II. were obtained.

TABLE II.

Length of Boom.	Volts on needle per mm. deflexion with P.D. of 80 volts across quadrants.							
	4½ in. needle.		4 in. needle.		3½ in. needle.		3 in. needle.	
	Single.	Double.	Single.	Double.	Single.	Double.	Single.	Double.
6½ in. ...	6	4	8.6	6.3	10	7.1	20.0	8.6
6 in. ...	8.3	4.4	10	4.5	12.1	6.8	16.6	8.2

There is thus a decided gain in the sensitiveness by using two vanes; but, as before mentioned, the results are only indicative of what might be expected in the finished instrument, and cannot be used for comparative purposes. It may not be out of place here to mention that on testing the openness of scale with one vane and with two vanes in the finished instrument, the former gave a deflexion of 11 volts per mm. under the same conditions that the latter gave 5.2 volts per mm., showing that the double-vaned needle gives double the openness of scale.

As a result of the preliminary tests the electrometer was constructed with a needle having two vanes 4½ in. in diameter, and a boom 6½ in. long.

Description of the Instrument.

Plate VI. fig. 1 is a photograph of the needle system with the boom attached. The vanes of the needle are made of aluminium 0.085 mm. thick, and in order to give the vanes rigidity the edges are slightly turned up as shown in the photograph.

In order to render the instrument fairly dead-beat it is necessary to have a strong damping attachment, but at the same time it was felt that a system that would do away with the usual dashpot arrangement of a platinum vane swinging in a jar of acid, with the surface tension effects on the needle and the usual troubles incident to this method, was much to be desired. This was accomplished satisfactorily by the Cambridge Scientific Instrument Co. by attaching to the rod of the needle a very light circular vane which swings between the poles of two strong permanent magnets, as shown in Plate VI. fig. 1. These magnets can be adjusted separately to suit the position of the vane.

The method of attaching the boom is shown diagrammatically in fig. 1. The rod B has a hook on each end to

Fig. 1.

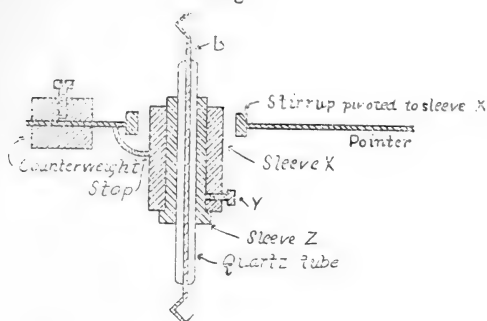

take the suspension and the needle respectively. This rod is insulated by the quartz tube to which are attached the sleeves to support the pointer and its counterpoise. In order to adjust the needle to any position with reference to the pointer or boom, the sleeve X can turn on the sleeve Z and is clamped in position by the screw Y. The counterpoise is just a little more than sufficient to balance the boom, but is prevented from falling below the horizontal position by a stop. This arrangement permits the end of the boom to be depressed without disturbing the needle or bending the suspension.

The weight of the different parts in grammes is:—

	Weight.
One vane	0.61 g.
" "	0.62 g.
Boom, counterpoise, needle, rod, &c.	8.23 g.
Damping vane	0.57 g.
Total.....	10.03

This shows then that the addition of the second vane only adds 6 per cent. to the weight, and permits as fine a suspension to be used for the two vanes as for one.

Two views of the completed instrument removed from its case are shown in Plate VI. figs. 2 and 3.

The quadrants are large enough to permit the use of $4\frac{1}{2}$ in. vanes, and the faces of the plates are $\frac{1}{4}$ in. apart*. The

* The faces of the plates were at first only $\frac{3}{8}$ in. apart, but it was found that when the potential on the needle exceeded 200 volts the attraction between the plates and the vanes of the needle was sufficient to cause the vanes to touch the plates and discharge, owing to the impossibility of adjusting them exactly parallel to the faces of the plates. The plates were then put $\frac{1}{4}$ in. apart, and the trouble ceased.

recording mechanism is shown in Plate VI. fig. 3. Just below the boom H is an inked thread or carbon paper parallel to the axis of the paper roller L. The bar J which is operated by a cam attached to the driving mechanism is allowed to drop once every two minutes, and in doing so depresses the boom H, causing the inked thread to strike the recording paper just below the boom, giving a dot which shows the deflexion of the needle at the instant of marking. The boom being pivoted as already described does not disturb the needle or bend the suspension.

The inked thread gives a short dash instead of a dot on the recording paper, and this is not as satisfactory as it might be when the potential is constantly changing. To obtain a dot instead of a dash, a narrow ribbon of ordinary carbon paper was employed for a time, and a slotted bar with a rod $1/16$ in. diameter resting in the slot had to be substituted for the roller L; when the boom was depressed it hit the carbon paper just above the rod, and left a small dot. This arrangement was very good so long as the room was dry, but if it got damp the boom was very liable to stick on the paper. The difficulties were finally overcome by taking a couple of threads out of a typewriter ribbon, twining them together and then doubling. This was used in the same way as the inked thread, and gave good results. It is a very simple matter to make in a few minutes sufficient thread to last for several months without requiring attention. The thread was stored on a spool, and was wound off at the rate of $1\frac{1}{2}$ in. per day on to another spool attached to the axis of the drum Q.

Clocks.—There are two separate clocks in the clock-case, the drum clock and slave clock. The drum clock drives the paper at a definite speed of 14 mm. per hour or 168 mm. per hour, according to whichever speed is required; generally the slower speed is used. The slave clock drives the cam wheel which operates the depressor bar at intervals of two minutes.

Charts.—A continuous paper movement is provided. The paper is stored on the drum P (Pl. VI. fig. 3), and passes up at the back of the drum Q, over roller L, down in front of drum Q, between friction rollers not shown, on to the storage-drum S, where it can be fixed by inserting the end of the paper in a slot provided for it. The spindle of S is provided with a cord the end of which can be fixed in any convenient position under the case. A weight and pulley not shown are then suspended on this cord, thus exerting a turning movement to the drum and keeping the paper taut while

passing through the instrument. Instead of using charts ruled with a time-scale, blank forms are used, and the time is given by an arrangement which brings a small rod under the depressor bar for about 6 minutes before the hour. This rod gives a dot near the edge of the chart every two minutes while it is under the bar, and it is so adjusted that the last dot of the series gives the hour mark. These marks are shown on the chart (fig. 5, p. 208).

Suspension.—Phosphor-bronze suspensions are employed in the usual manner, and it is found that wire 0.002 in. in diameter gives good stability.

Automatic zero.—The drum Q makes two revolutions in 25 hours, and advantage was taken of this to attach an arrangement whereby the needle was earthed for about 12 minutes, during each revolution of the drum. The zero position is thus automatically given twice a day.

Results.

Fig. 2 gives an actual trace of the instrument for a leakage test. This shows that the insulation is of a very high order.

Fig. 2.

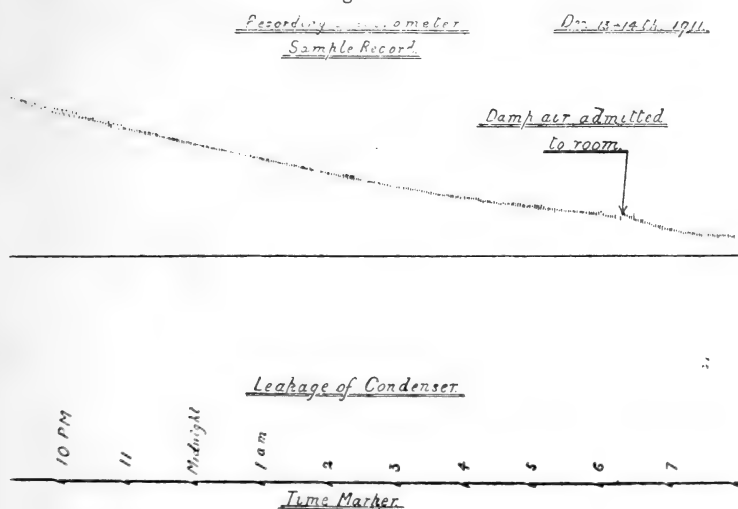

Table III. gives some of the tests made on the sensibility. One pair of quadrants was connected to the positive terminal of the battery, the other pair to the negative, and the centre of the battery was earthed.

TABLE III.

Needle charged to	Quadrants charged to								One pair quadrants earthed, other charged to	198.4 volts on needle.	
	7.9 V.		11.95 V.		15.95 V.		39.7 V.			Defl. in mm.	Volts per mm. defl.
	Defl. in mm.	Volts per mm. defl.	Defl. in mm.	Volts per mm. defl.	Defl. in mm.	Volts per mm. defl.	Defl. in mm.	Volts per mm. defl.			
20.0 V.	5.5	3.6	2.0 V.	3.2	0.63
40.0	2.25	17.8	3.65	11.0	4.5	9.0	10.8	3.7	3.9	6.4	0.61
59.9	16.2	3.7	5.9	8.5	0.69
79.6	4.5	17.5	6.8	11.7	8.8	9.0	22.2	3.6	9.95	13.7	0.65
119.2	6.4	18.6	10.4	11.4	13.4	8.9	14.0	20.7	0.67
158.8	9.2	17.3	14.2	11.2	18.2	8.7	19.8	28.2	0.70
238.5	14.2	16.7	22.4	10.7							
Mean	17.6		11.2		8.9		3.65			0.66
A=	139.0		133.8		141.9		144.9				131.0

A = Potential difference of quadrants \times volts per mm. deflexion.

Fig. 3.

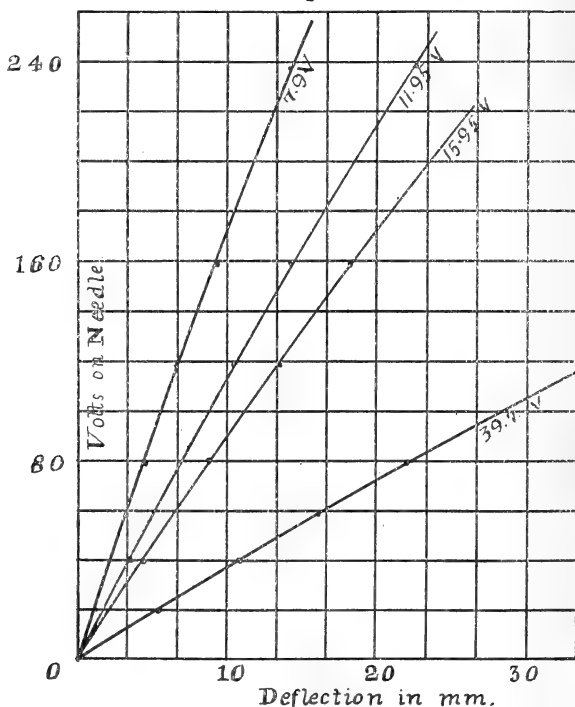

These results are plotted in fig. 3. In fig. 4 the mean deflexions per mm. for the different potentials across the quadrants are plotted.

Fig. 4.

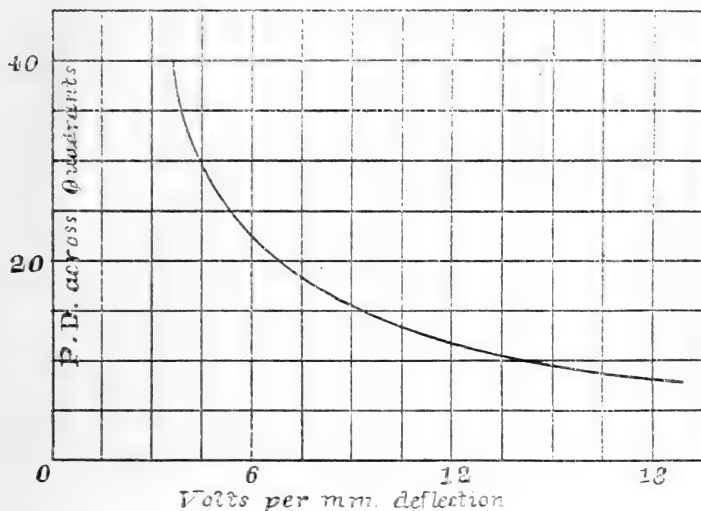

The results show that the instrument has a high degree of sensitiveness, and that it is constant within 5 per cent. over the range of the scale. The error in taking the tangent instead of the arc is only 2 per cent., but it is necessary, of course, to calibrate the instrument for the particular potentials that are used.

The probable error in the readings of the instrument will depend chiefly on the accuracy with which the dots on the charts can be read. This error would not be more than .5 mm. at the most, and would generally be less.

The capacity of the needle and of either pair of quadrants is about 100 cm.

In measuring the potential of the air a polonium collector was used. The collector was 8 ft. 6 in. above the ground and 9 ft. from the building, which was 10 ft. high to the eaves; one pair of quadrants was attached to the positive terminal of a battery of 12 volts and the other pair to the negative, the centre being earthed. A copy of a record of the potential is given in fig. 5 (p. 208). The record was obtained when

an area of high pressure was approaching, giving very frosty weather and fairly clear skies.

Fig. 5.

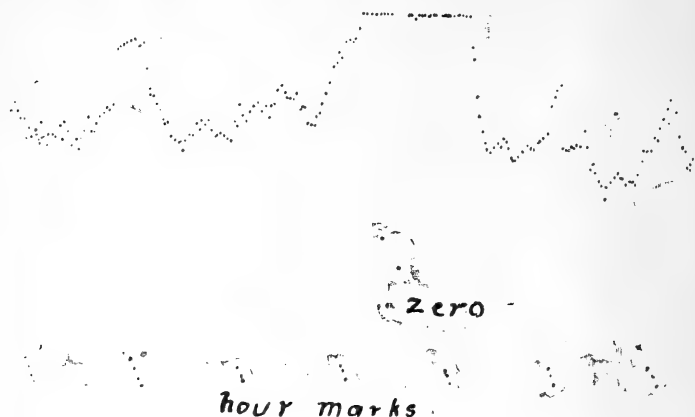

Conclusion.

The question naturally arises whether it is better to make a needle with two vanes rather than an equivalent single vaned needle.

If one increased the sensitiveness by increasing the size of the needle, the best that it would be possible to do would be to make an instrument that had its plates the same distance apart for the larger as for the smaller needle, and that had the needles constructed of material of the same gauge. In this case, if the linear dimension of the needle were multiplied by μ , the capacity would be multiplied by μ^2 . The surface density for the same voltage would not change, nor the electro-mechanical force per unit area, nor the moment about the suspending wire of the electric force per unit area. The total moment would then be increased by μ^2 , or the deflecting force on the needle would be multiplied by the increase of the area of the needle. Thus if the area of the needle were doubled the weight would be doubled, and the deflecting force doubled. This is the best that it would be possible to obtain. If it is assumed that it is possible to obtain this condition, would it give an instrument as sensitive as one obtained by adding two vanes and using double-celled quadrants? Almost the whole weight of the suspended system is in the

boom and its counterpoise, and the weight of the vane can be neglected, so that by doubling the area of the needle the deflecting force would be doubled, and the sensitiveness of the instrument would be doubled also, provided the boom and its counterpoise were the same as before. Now as the boom and counterpoise are the chief factors in limiting the sensitiveness of the instrument, it might be assumed that it would have been much simpler to have increased the size of the needle and obtained the same result in that way. The preliminary experiments indicated that the $6\frac{1}{2}$ in. boom was the best. Having used the best length of boom and made the diameter of the quadrants as great as possible for this length of boom, the best arrangement of boom and needle was obtained. Any further increase in the needle would have necessitated a longer boom, and owing to the additional weight would have required a stronger suspension, thus largely counteracting any gain obtained by the increased size of the needle. There remained therefore the method, which was adopted, of double decking the quadrants and using a two-vaned needle, to obtain the greater sensitiveness.

Another question that arises is as to whether an instrument that requires a battery of a few volts can be kept as constant as a battery of 100 volts or more. In this instrument a P.D. of 12 volts across the quadrants is sufficient for measuring the potential of the air; a reference to fig. 4 will show that a change of 1 per cent. in the voltage will cause a change of about 1 per cent. in the readings of the instrument. A change of .5 volt in a battery of 12 volts would be large when no current is being used, yet this would not alter the value of the readings by more than 4 per cent.

The advantages claimed for the instrument are :—

1. Simplicity of construction.
2. Little attention required when in working condition.
3. High degree of sensibility enabling the potential of the air to be measured with a battery of only a few volts.
4. Fair uniformity of scale over the range of the recording paper.

XIV. *The Reflexion of the X-rays.* By H. G. J. MOSELEY, M.A., John Harling Fellow, and C. G. DARWIN, M.A., Lecturer in Mathematical Physics in the University of Manchester*.

THE discovery in July 1912 by Friedrich and Knipping † that the X-rays can show interference has opened up a new region to research. It had been suggested to them by Laue that the ordered arrangement of the atoms in a crystal would do the same for X-rays that a diffraction-grating does for light. They therefore sent a fine beam of X-rays through a thin crystal of zinc-blende on to a photographic plate. After prolonged exposure to the radiation the plate showed an elaborate system of spots surrounding the central image. These spots were caused by fine beams of X-rays, which came from the crystal. Explanations of this phenomenon have been offered by Laue † and by W. L. Bragg ‡. Laue assumes the radiation to consist of a finite number of monochromatic waves, while Bragg believes it to be similiar in constitution to white light. The explanation of the latter accounts perfectly for the positions of the spots in question. The present paper shows that a large proportion of the radiation from an X-ray tube has no definite wave-length, but that five types of monochromatic waves are also present in the radiation from a tube with a platinum target. The following is a brief statement of W. L. Bragg's theory.

It is known that every atom in a crystal scatters a small fraction of the incident radiation. Since the atoms are regularly arranged these scattered disturbances have definite time relations. In certain directions a number of scattered disturbances reinforce one another, and so give rise to a new disturbance of considerable strength. The co-operating disturbances come from atoms which lie in a plane. This plane, the incident beam, and the direction of the new beam have the same geometrical relation as have a mirror, an incident ray, and the reflected ray. Wherever a plane containing many atoms can be drawn in the crystal a ray will be found in the direction which is the reflexion in this plane of the incident beam. The position of every spot in Friedrich and Knipping's photographs can be found from this principle. A cleavage-plane is exceptionally rich in atoms, and Bragg §

* Communicated by Prof. E. Rutherford, F.R.S.

† Laue, Friedrich and Knipping, *Kgl. Bay. Akad.* p. 303 (1912).

‡ W. L. Bragg, *Proc. Camb. Phil. Soc.* xvii. p. 43.

§ W. L. Bragg, 'Nature,' vol. xc. p. 410, Dec. 12 (1912).

confirmed his theory by throwing a beam of X-rays on to a cleavage surface of mica, and observing a strong image in the position which an optically reflected beam would occupy.

So far, the subject had been developed entirely by photography. The first object of our investigation was to test whether the "reflected" radiation, which was so clearly shown to have an extended wave-front, possessed those properties which have led Prof. W. H. Bragg to suggest that X-rays are corpuscular. It was still possible that the X-rays were really a mixture of two different constituents.

At first we followed the experimental arrangement of Friedrich and Knipping. When, however, W. L. Bragg discovered that a greater effect was obtained by "reflexion" from mica, his method was adopted, and was found to be much more convenient. Later W. H. Bragg* announced in 'Nature' that the reflected radiation ionized air, and we † were able to add that it had all the principal properties which characterize ordinary X-rays. We then tried to determine how the intensity of reflexion depends on the angle of incidence on the surface of a crystal. We first measured the reflexion from selenite, and found that as the angle of incidence was varied from 88° to 55° the reflexion fell to a thousandth of its initial value. Our results showed certain singularities, which we hoped to explain by studying other crystals. At this stage, however, Prof. Bragg very kindly communicated to us results obtained with other crystals, which he has since published in conjunction with Mr. W. L. Bragg ‡. They found the intensity of reflexion to be abnormally large at certain angles. They attributed this selective reflexion to the presence in the radiation of monochromatic waves. These waves were thought to be characteristic radiation from the platinum target in the X-ray tube. When the phase difference between the waves "reflected" from successive layers of atoms is 2π , the waves reinforce one another in the reflected beam. In the light of this communication we re-examined the reflexion from selenite. We found that this was the cause of the singularities which we had noticed. By using very fine slits we had missed the position at which the principal selective reflexion occurs. Our later work, in which selenite, rocksalt, and potassium ferrocyanide have been used as reflectors, fully confirms the conclusions of Prof. and W. L. Bragg. At the

* W. H. Bragg, 'Nature,' Jan. 23 (1913).

† Moseley and Darwin, 'Nature,' Jan. 30 (1913).

‡ Proc. Roy. Soc. A, vol. lxxxviii. p. 428.

same time a careful study of the general reflexion from these crystals has thrown some light on the nature of the ordinary X-rays.

The Apparatus.

In the course of the present work the experimental arrangements have frequently been refined, and the methods which finally proved satisfactory will alone be described. The general plan was to allow a beam of X-rays to fall on to a crystal and examine the radiation from its surface by means of a movable ionization chamber. This part of the apparatus will in future be called the detector.

The X-rays.—The source of the X-rays was a Müller tube with platinum target. The beam of radiation was limited by two parallel lead slits 3 cm. long, 0.5 mm. broad, and 20 cm. apart. They are marked P and Q in fig. 1, which

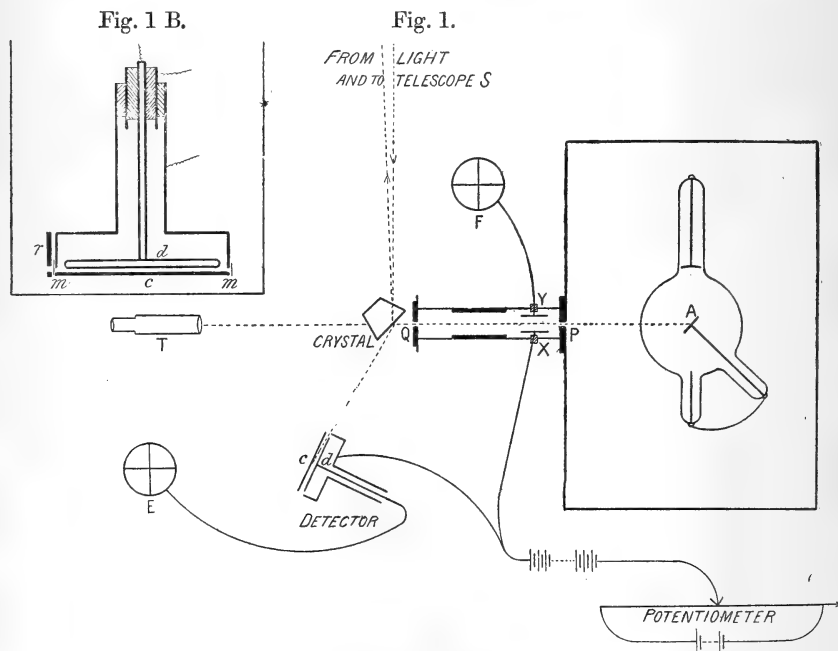

shows the general arrangement of the apparatus. The slits stopped the radiation from all but a small strip of the target, and it was therefore important that the cathode stream falling on it should be focussed to a point. The tube was excited by a coil with a Sanax mercury break. A current of some 6 amps. was sent through the primary circuit, and

this gave a current of about 0.3 milliamp. through the tube. The tube was enclosed in a thick lead box, and the coil surrounded by an earthed tin case.

The Reflector.—Three different crystals were used for reflecting the radiation: rocksalt (NaCl), selenite ($\text{CaSO}_4, 2\text{H}_2\text{O}$), and potassium ferrocyanide ($\text{K}_4\text{FeCy}_6, 3\text{H}_2\text{O}$). The last of these was a magnificent specimen, with a perfect face 6 cm. square. A perfect face of selenite was easily obtained by cleavage. All the available specimens of rocksalt were contorted, but one was eventually found with a sufficient area of flat surface. The faces used were a cube face in rocksalt, and the principal cleavage-planes in selenite and potassium ferrocyanide.

The Mounting.—A dismantled spectrometer was used to carry the principal parts of the apparatus. The crystal was set up with its surface on the axis of the spectrometer. The slits P and Q were fixed in the place of the collimator, and the detector on the arm which usually carries the telescope, while each crystal was permanently mounted on a table, the legs of which could rest in the V grooves of the prism table. The slits were parallel to this axis and pointed at it. The beam therefore struck the crystal surface in a fine line, and however the crystal was turned, the line remained stationary on the axis of the spectrometer. This line was perpendicular to the direction of the incident beam and so the angles of incidence of the rays at the ends and at the centre of the slit were almost exactly equal.

The Adjustment.—A telescope T was kept permanently pointing at the axis of the spectrometer. The focus spot on the target A, the slits P and Q, and the surface of the crystal were set accurately in the plane defined by the axes of the telescope and spectrometer. The first of these adjustments was made by covering with lead all but the centre of P, and moving the X-ray tube until the bright spot on a fluorescent screen placed at Q was brought on to the axis of the telescope.

Measuring the angles.—The position of the arm which carried the detector could be read on the divided circle of the spectrometer to within 30". The prism-table, however, carried no vernier and a second telescope S was used to define the position of the crystal. A piece of plate-glass was fixed on to the crystal at such an angle that when the crystal surface was parallel to the X-ray beam a fixed light was reflected by the glass on to the cross-wires of S, which was 3 metres distant. The crystal was first set to this standard position and then turned together with the detector through

the required angle. In practice the glass was never fixed on the crystal at exactly the correct angle, and the error had to be determined for each crystal by optical methods. At a later stage, after the fact that the X-rays obey the ordinary laws of reflexion had repeatedly been verified, it was found easier to calculate the error by setting crystal and detector at the estimated position of reflexion and then turning both together until the reflected beam entered the detector.

The Path of the Rays.—The detector turned on the telescope arm of the spectrometer, and was always 20 cm. from the crystal. The distance to the crystal from the target was 40 cm., and so the rays always passed through 60 cm. of air. A large fraction of the softest constituents of the beam was therefore absorbed before reaching the detector. Much would be gained by removing the air from the path of the rays, but this refinement would have been inconvenient, because the arrangement of slits and crystal had constantly to be altered. There were two reasons for putting the detector so far from the crystal. In the first place the effect of the general scattered radiation, which comes from the crystal in all directions, was thereby diminished. In the second place the direction of the reflected beam could be determined with increased accuracy. The distance between P and Q had to be made large to ensure the rays being sufficiently parallel. Distance, combined with the use of two fine slits, is the only possible way of collimating a beam of X-rays.

The Detection of the Rays.—The fine slits, the distance from the target, and the small reflexion coefficient of the radiation together reduced the intensity of the beam which reached the detector to a minute fraction of the total radiation. It was therefore necessary to measure this intensity by a method which should be both sensitive and fairly accurate over a very wide range. A method was also needed which would discriminate against the natural ionization, which was very troublesome. The following plan proved to be quite satisfactory. The reflected beam struck a metal plate at almost glancing incidence. Laub* has shown that under these conditions the emission of corpuscular radiation by X-rays is very greatly increased. This effect was found to occur equally for the reflected radiation. The metal plate was surrounded by helium at nearly atmospheric pressure. The ionization of the helium by the corpuscular radiation was greatly increased by using the principle of ionization by collision. An electric field was

* *Ann. d. Physik*, xxvi, p. 712 (1908).

maintained in the gas which was just not sufficient to cause the passage of a spark. Townsend has shown that both positive and negative ions then acquire sufficient speed to produce fresh ionization, and that the current through the gas is in this way multiplied by a large but constant factor. This method was first employed by Griffith*, who used it in quantitative measurements of the photoelectric effect. Rutherford and Geiger† in their electrical method of counting α particles were the first to use helium.

The Detector.—The detector was a gas-tight brass box 10 cm. long, 2 cm. broad, and $4\frac{1}{2}$ cm. deep, fixed to the telescope-arm by an ebonite block. It is shown in section in fig. 1 B. The rays entered at one end by a thin mica window *m* surrounded by a lead screen *r*. They fell at a very oblique angle on the plate *c*. This plate was one side of the box, which was kept charged to a potential of about 800 volts. A plate *d* accurately parallel to *c* and 2.8 mm. from it was connected to an electrometer. The connecting wire, which was insulated from the box by ebonite plugs and a guard-ring, passed to the axis tube of the spectrometer, and down it to the electrometer. It was therefore not disturbed by moving the detector.

The Helium.—Ionization by collision may be obtained by the use of helium at a very much higher pressure for a given potential difference than is possible with air. The great ease with which helium may be purified is also an advantage. It was purified by passing it over charcoal cooled in liquid air, and it was then pumped into the detector, which was temporarily connected to the purifying apparatus by a glass tube fitted with ground joints. It was found advisable to clean the helium every few weeks, since the natural ionization in the detector, at first very small, increased markedly after some time. This curious effect suggests that, as in the stagnant air of cellars, radium emanation gradually diffused from the walls of the box. The properties of pure helium are affected to an extraordinarily marked degree by the presence of traces of impurity. It was therefore not surprising that when the apparatus was first used, the factor by which a given difference of potential increased the ionization current was found to fall off very rapidly, owing to the contamination of the helium by traces of other gases coming from the walls of the box. This trouble was overcome by using helium mixed with a trace of air. The sparking potential was in this way raised by about a hundred volts,

* Griffith, *Phil. Mag.* xiv. p. 297 (1907).

† Geiger and Rutherford, *Phil. Mag.* xxiv. p. 618 (1912).

and the gas was then no longer sensitive to impurities. After some months this trouble ceased, and the helium could be used almost pure.

The Measurements.—The factor by which the ionization current between c and d was increased by collision could be adjusted to any desired value by altering the potential of c by a few volts with the aid of a potentiometer. A factor of 50 was most frequently used, and it was usually not convenient to work with a factor much greater than 100. When the multiplication was too great the readings became unsteady and the natural ionization gave trouble. In order to detect variations in the primary X-rays a pair of parallel plates X and Y (fig. 1) were placed in front of the slit P. The beam of rays passed between them, and the resulting saturation ionization current was measured by a second electrometer F, with which was connected a large capacity.

General Properties of the Reflected Radiation.

Explanations of the “reflexion” of the X-rays are based on the assumption that the reflected beam is due to the co-operation of a number of the waves of scattered radiation which come from the atoms traversed by the primary beam. It is well known that the scattered radiation is in every way similar to the rays which excite it. A description will now be given of some simple experiments which show that this is equally true in the case of the “reflected” radiation.

(1) *Ionization of gases.*—A fine beam of radiation reflected from mica was sent straight down the detector and did not touch the plates c and d . Considerable ionization was produced in air, and slight ionization in helium.

(2) *Corpuscular radiation.*—The detector was moved a little to one side. The beam now touched c or d . The ionization in air was somewhat increased; the ionization in helium was increased some ten times. As the angle at which the beam hit the metal plate was altered, the ionization changed rapidly, being largest at almost glancing incidence.

(3) *Ionization at different pressures.*—The detector was set slightly aslant, so that the whole reflected beam fell on c , and the corpuscular radiation was a maximum. The ionization was measured in air at pressures between 10 cm. and an atmosphere. The crystal was then removed and the same process carried out with the primary beam. The two beams happened to be equally penetrating and the two curves were indistinguishable. In both cases the effect of the corpuscular radiation and its absorption by the air at the higher pressures

was very marked. Potassium ferrocyanide was here used as reflector.

(4) *Absorption.*—The primary and reflected beams were usually not equally penetrating. The cause of this was thought to be the unequal reflexion of different constituents. It was conceivable, however, that a special type of radiation was manufactured by the crystal. This point was tested in an experiment in which mica was used as reflector, and the reflected beam happened to be considerably the more penetrating. An aluminium sheet was placed alternately in the path of the primary and reflected beams. The reflected radiation was the same in the two cases.

All these experiments show clearly that the primary and reflected radiations consist essentially of the same constituents, but that these constituents are present in different proportions in the two beams.

The General Reflexion at different Angles of Incidence.

The next step was to determine how the intensity of reflexion depends on the angle at which the radiation strikes the surface of the crystal. It was soon apparent that the strongest reflexion occurs at almost glancing incidence, and that at an angle less than 55° the reflexion becomes too small for measurement. For the future therefore the glancing angle, that is the angle made by the rays with the surface of the crystal, will be used instead of the angle of incidence. The crystals used were all so thick that at no angle would an increase in thickness have improved the reflexion. For the smaller angles the primary beam was limited by fine slits at P and Q. As the crystal was turned round the detector was turned through twice the angle, so that it always caught the whole reflected beam. At the larger angles it was necessary to use wider slits, and then the detector only intercepted the central part of the reflexion. When changing the slits careful comparative measurements were made at one or two angles, so that all the results could be reduced to a common standard. There were two reasons for using fine slits at small angles. In the first place it was essential that the whole beam should strike the crystal, and no radiation get past it. Secondly, the variation of reflexion with angle was sometimes so rapid that it was necessary to avoid any sensible divergence in the beam. This was particularly important near those angles at which the selective reflexion occurred. When these special angles had been accurately measured, they could always be avoided in finding the shape of the general curve. In giving the results obtained for the general reflexion we have as far as

possible eliminated the effect of selective reflexion, since the prominence of the latter in the general intensity curves depends entirely on the arrangement of the slits. In the curves given in fig. 2 the special angles are marked with letters, the meaning of which will be explained later. In these curves the intensity is plotted against the glancing angle. It was found that the shape of a curve was greatly influenced by the state of the tube. As an example of this, an experiment may be mentioned in which rocksalt was used as the reflector. The radiation from the tube was allowed to become gradually softer. The maximum of the curve was at first close to 4° . During the course of the experiment it shifted systematically towards the broader angles and finally approached 6° . Doubtless if a great part of the soft radiation had not been absorbed in its passage through the air, the maximum would have occurred at a still larger angle. It was therefore most important that the state of the tube should remain constant, and the results suffer somewhat from the impossibility of fulfilling this condition accurately. It was found that the tube usually remained much steadier if it was kept warm by burning an electric lamp inside the lead box. The tube was run for half a minute at regular intervals of two minutes. As soon as the rays were cut off, the electrometer E was disconnected from the detector, in order to avoid the natural ionization in the detector during the time taken by the needle to come to rest. The ratio of the readings of the two electrometers E and F was taken to be a measure of the intensity of reflexion, after allowing for the natural effect in the detector. In the more accurate work the current through the detector was measured by a balance method. It was found in practice that F did not give an entirely reliable measure of the intensity of the primary beam, probably because the focus point of the cathode stream was liable to shift, and this affected F very little, while it made a great difference in the amount of radiation which got through the second slit. It was therefore necessary to take the reflexion at one angle as a standard and return to it after every few readings. In fig. 2, curve I. refers to reflexion from selenite. The state of the tube remained very nearly constant during the course of the experiment, which took several days to complete. Curve II. was taken with rocksalt and curve IV. with potassium ferrocyanide. The state of the tube was roughly the same in the three cases and 1 mm. of aluminium cut down the primary beam by 50 or 60 per cent. Curve III. was taken with the ferrocyanide crystal after hardening the primary beam by passing it through 1 mm. of aluminium.

Fig. 2.

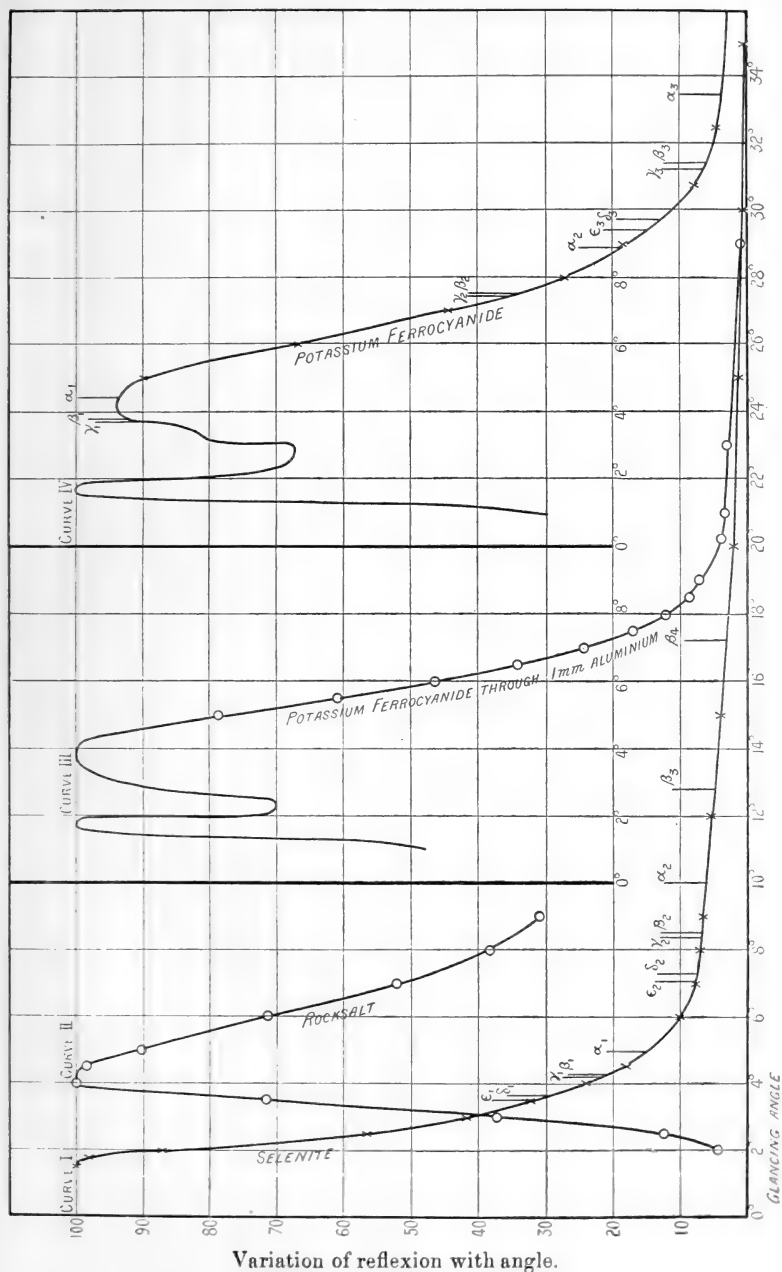

Much information on the way in which constituents of differing penetrating power are reflected at different angles can be obtained from a comparison of curves III. and IV. A direct determination was also made of the extent to which the rays, reflected at different angles from rocksalt, were absorbed by 1 mm. of aluminium. The state of the tube was the same as for curve II. The absorption was found to be 23 per cent. at 3° , 33 per cent. at 4° , 53 per cent. at 6° , and 63 per cent. at 8° , while for the primary beam it was 59 per cent. The measurements at very small angles were not easy to make, since, if the adjustment either of the slits or of the crystal was slightly in error, part of the primary beam failed to strike the surface of the crystal. This point was carefully tested optically, and the diminution of the efficiency of reflexion from ferrocyanide and rocksalt at very small angles is certainly a genuine effect. A similar result was obtained with selenite but was not accurately measured. The upper parts of curves III. and IV. have been drawn from the results of a number of experiments. All showed the general characters depicted, though the results obtained on different days were not in perfect agreement. These curves will be discussed later, after the simpler case of reflexion of monochromatic radiation has been considered.

Even at the most favourable angle a crystal reflects only a small fraction of the general incident radiation. The actual reflexion coefficient depends to a certain extent on the quality of the primary radiation. Under the usual working conditions it was found that the selenite crystal gave a maximum reflexion coefficient $\cdot 0037$ at $1\frac{1}{2}^\circ$, while the ferrocyanide gave a maximum of $\cdot 0035$ at $1\frac{3}{4}^\circ$. In the earliest experiments* a reflexion coefficient of $\cdot 01$ to $\cdot 02$ was found for mica, but it is probable that in this case the surface was slightly curved and chanced to focus the very broad incident beam into the narrow opening of the detector. Since then mica has been little used, owing to the difficulty in obtaining a flat surface, but in the later work the reflexion coefficient found for this crystal has certainly not been greater than about $\cdot 005$.

The Selective Reflexion.

It has already been mentioned that, while these experiments were in progress, Prof. W. H. and W. L. Bragg † discovered that certain crystals reflected exceptionally well at three

* Moseley and Darwin, *loc. cit.*

† W. H. and W. L. Bragg, Proc. Roy. Soc. A. lxxxviii. p. 428 (1913).

special angles. They found that at each of these angles a particular type of radiation was selectively reflected. The special angles differed from crystal to crystal but the three types of radiation were always the same. They explained these results by assuming that the platinum target emitted three characteristic types of monochromatic waves. The beams reflected from the successive layers of atoms in the crystal generally destroyed each other by interference. When, however, the wave-length λ , the distance d between the layers, and the glancing angle θ were connected by the relation

$$n\lambda = 2d \sin \theta (1)$$

the separate beams reinforced one another, and the monochromatic radiation was selectively reflected. The three types of radiation represented three different values of λ , and in the reflexion from rocksalt special angles were found corresponding to $n=1$ and to $n=2$. These angles may by analogy be said to refer to reflexion in the first and second order.

We have studied in detail the selective reflexion from the principal cleavage-planes of rocksalt, selenite, and potassium ferrocyanide. The most complete search was made in the case of ferrocyanide. The general radiation is reflected at all angles, while the selective reflexion may for practical purposes be said to occur only at precisely the correct angle of incidence. For this reason the ratio of the selective to the general reflexion is greatly increased by limiting the breadth of the slits and so increasing the parallelism of the primary beam. Unfortunately, a very small rotation of the crystal will then remove all traces of the selective effect. It therefore proved necessary to take readings with the crystal set at every 5' of arc between 1° and 14° . In the case of selenite most of the special angles were already approximately known from the singularities in the original intensity curves, the meaning of which had not been appreciated at the time. Prof. Bragg most kindly told us the positions of his three special angles in rocksalt, and a search for others was made only in those places which theory suggested as possible. The positions of the special angles were first found roughly, and then the crystal was turned minute by minute until the angle which gave the maximum reflexion was definitely determined. The opening in the detector was wide enough to include the whole reflected beam, and it was made to follow this beam when the crystal was rotated. Several of the special angles were found with the crystal set on both sides of the

primary beam. As soon as the correct position was determined, the crystal was turned through an angle A into the position defined by the telescope S , the lamp, and the plate glass. The corresponding position was then found on the other side, and the crystal turned through the angle B into the standard position, using this time the other side of the glass. As the faces of the glass were strictly parallel, the special angle was given by $\frac{1}{2}(A+B)$.

The values found for the special angles are tabulated below. Those in Tables I. and II. are probably correct to within about $1'$, but in Table III. the error may be twice as great.

Angles of Special Reflexion.

TABLE I. Rocksalt, NaCl. Cube face.	First Order...	α_1 .	β_1 .	γ_1 .	δ_1 .	ϵ_1 .
	θ	$13^\circ 31'$	$11^\circ 28'$	$11^\circ 17'$	$9^\circ 47'$	$9^\circ 29'$
	$\sin \theta$	$\cdot 2337$	$\cdot 1988$	$\cdot 1956$	$\cdot 1699$	$\cdot 1647$
	$\sin \theta \times 5 \cdot 030 \dots$	$1 \cdot 176$	<u>$1 \cdot 000$</u>	$\cdot 984$	$\cdot 855$	$\cdot 829$
TABLE II. Potassium Ferrocyanide, $K_4FeCy_6 \cdot 3H_2O$. Principal cleavage face.	First Order...	α_1 .	β_1 .	γ_1 .	δ_1 .	ϵ_1 .
	θ	$4^\circ 26'$	$3^\circ 46\frac{1}{2}'$	$3^\circ 43\frac{1}{2}'$	not	found.
	$\sin \theta$	$\cdot 0773$	$\cdot 0657$	$\cdot 0650$	—	—
	$\sin \theta \times 15 \cdot 11 \dots$	$1 \cdot 168$	$\cdot 995$	$\cdot 982$	—	—
	Second Order...	α_2 .	β_2 .	γ_2 .	δ_2 .	ϵ_2 .
	θ	$8^\circ 55\frac{1}{2}'$	$7^\circ 33\frac{1}{2}'$	$7^\circ 28\frac{1}{2}'$	not	found.
	$\sin \theta$	$\cdot 1551$	$\cdot 1315$	$\cdot 1301$	—	—
	$\frac{1}{2} \sin \theta \times 15 \cdot 11 \dots$	$1 \cdot 172$	$\cdot 994$	$\cdot 983$	—	—
	Third Order...	α_3 .	β_3 .	γ_3 .	δ_3 .	ϵ_3 .
θ	$13^\circ 28\frac{1}{2}'$	$11^\circ 27'$	$11^\circ 16'$	$9^\circ 45\frac{1}{2}'$	$9^\circ 27\frac{1}{2}'$	
$\sin \theta$	$\cdot 2330$	$\cdot 1985$	$\cdot 1954$	$\cdot 1695$	$\cdot 1643$	
$\frac{1}{2} \sin \theta \times 15 \cdot 11 \dots$	$1 \cdot 174$	<u>$1 \cdot 000$</u>	$\cdot 984$	$\cdot 854$	$\cdot 828$	
TABLE III. Selenite, $CaSO_4 \cdot 2H_2O$. Principal cleavage face.	First Order...	α_1 .	β_1 .	γ_1 .	δ_1 .	ϵ_1 .
	θ	$4^\circ 59'$	$4^\circ 16\frac{1}{2}'$	$4^\circ 13\frac{1}{2}'$	$3^\circ 39'$	$3^\circ 32'$
	$\sin \theta$	$\cdot 0869$	$\cdot 0745$	$\cdot 0736$	$\cdot 0637$	$\cdot 0616$
	$\sin \theta \times 13 \cdot 53 \dots$	$1 \cdot 175$	$1 \cdot 009$	$\cdot 997$	$\cdot 861$	$\cdot 834$
	Second Order...	α_2 .	β_2 .	γ_2 .	δ_2 .	ϵ_2 .
	θ	$9^\circ 58\frac{1}{2}'$	$8^\circ 30'$	$8^\circ 22\frac{1}{2}'$	$7^\circ 17'$	$7^\circ 3'$
	$\sin \theta$	$\cdot 1731$	$\cdot 1478$	$\cdot 1457$	$\cdot 1268$	$\cdot 1228$
	$\frac{1}{2} \sin \theta \times 13 \cdot 53 \dots$	$1 \cdot 172$	<u>$1 \cdot 000$</u>	$\cdot 985$	$\cdot 858$	$\cdot 830$

The positions of the special angles are indicated on the curves in fig. 2. The five angles found for rocksalt agree in position with the three found by Bragg. His slits were too broad to separate β from γ or δ from ϵ . If the way in which the atoms are packed in the simple cubical crystal rocksalt is known, the wave-lengths of these five characteristic radiations can be determined.

If N is the number of molecules in 1 gram mol., M the molecular weight, and σ the density of the rocksalt, the number of molecules per c.c. is $\frac{N\sigma}{M}$. This number is, however, $\frac{K}{d^3}$, where d is the distance between successive layers of atoms and K a numerical constant, the value of which depends on the arrangement of the atoms in the crystal. Hence

$$\lambda = 2d \sin \theta,$$

and

$$\frac{K}{d^3} = \frac{N\sigma}{M}.$$

Now $N = 6.22 \times 10^{23}$, $M = 58.46$, and σ was found to be 2.167. This gives $d = K^{\frac{1}{3}} \times 3.513 \times 10^{-8}$ cm.

It follows that the wave-lengths of the five radiations $\alpha, \beta, \gamma, \delta, \epsilon$ are 1.642, 1.397, 1.375, 1.194, $1.157 \times K^{\frac{1}{3}} \times 10^{-8}$ cm. It is probably an accident that the first, second, and fourth, also the first, third, and fifth of these numbers are in geometrical progression. These values for the wave-lengths are no doubt slightly too large, as crystals are apt to contain minute inclusions of gas or liquid, which would make the experimental value of σ slightly too low. The absorption coefficient of the characteristic radiation β in aluminium was found to correspond to that of the K radiation from an element of atomic weight about 7.55. In order to excite this radiation a cathode particle should have a velocity* about 7.55×10^9 cm. per sec., which corresponds to an energy content 2.5×10^{-8} erg. If Planck's formula holds good the energy of the radiation β should be given by $h\nu$, where h is 6.455×10^{-27} erg. sec. † and ν is the frequency of β . Therefore

$$h\nu = h \cdot \frac{c}{\lambda} = 1.37 \times K^{-\frac{1}{3}} \times 10^{-8} \text{ erg.}$$

If all the molecules are arranged in a simple cubical pattern

* Whiddington, Proc. Roy. Soc. A. lxxxv. p. 323 (1911).

† Westphal, *Deutsch. Phys. Gesel.* xxi. p. 987 (1912).

$K=1$; and if it is the atoms which are so arranged, $K=\frac{1}{2}$. If, however, the atoms are arranged at the corners and the centres of faces of cubes, $K=\frac{1}{8}$. As the arrangement of the atoms in a salt crystal is still in doubt, there remains this factor of uncertainty in the determination of the wave-lengths.

It will be seen by comparing the results obtained with the three different crystals that equation (1) is accurately satisfied. First, in Tables II. and III. the five radiations will be seen repeated in different orders, that is with different values of n . Higher orders were also observed but not measured accurately. Secondly, it is clear that d is a constant for the same crystal, since the sines of the angles have the same ratio in each case. The characteristic radiations β_1 and γ_1 in ferrocyanide and in selenite were too close together to be properly separated. It was, however, quite clear in both cases that two components were present, and that they were about $3'$ apart. For the purpose of finding wave-lengths the values found in the higher orders are, of course, the more accurate. Measurements of the absorption in aluminium of β_3 from ferrocyanide and β_1 and β_2 from selenite showed that these were all the same radiation. The absorption coefficients were found by taking the difference between the intensities of reflexion at the special angle, and at a neighbouring angle, first with the detector bare and then with aluminium in the way. The approximate values found for the mass-absorption in aluminium of the four radiations α_3 , β_3 , γ_3 , δ_3 from ferrocyanide gave 34, 22, 19, 16 (g. per sq. cm.)⁻¹ respectively. The absorption of ϵ_3 was not measured, as this type of radiation was much weaker than the others. All these radiations were greatly reduced by absorption in passing through 60 cm. of air on their way to the detector, and no attempt was made to obtain at all accurate values for the absorption coefficients with this apparatus. As one would anticipate, the absorption increases rapidly with the wave-length. Thus the wave-lengths of α and δ are in the ratio of 1.37:1, while the absorption coefficients are roughly as 2.12:1. The so-called L characteristic radiation from platinum, which Chapman found to have a mass-absorption coefficient of 22.2* in aluminium, seems to correspond roughly with the monochromatic radiation β . The absorption in aluminium of β_1 from ferrocyanide appeared to be abnormally low. Here, however, the characteristic radiation contributes only 25 per cent. to the whole reflexion, and the discrepancy may be explained by supposing that the general reflexion, which is

* Proc. Roy. Soc. A. lxxxvi. p. 439 (1912).

much more penetrating, had a slight maximum in the neighbourhood of this angle.

The different orders and different types of characteristic were by no means equally conspicuous. The relative intensities after subtracting the effect of the general reflexion are given for the case of ferrocyanide in Table IV. The

TABLE IV.
Intensity of Selective Reflexions.

	α .	β .	γ .	δ .	ϵ .
First Order	38	62		—	—
Second Order.....	—	28	—	—	—
Third Order	58	<u>100</u>	74	44	14
Corrected for absorption by air }	99	140	100	56	17

relative intensities found for the different types of radiation have little definite meaning. In the first place they have been cut down by absorption to very different extents. If allowance were made for absorption in glass, air, and mica, probably the true intensities would be in the same order as the wave-lengths, α being the strongest and ϵ much the weakest. In the second place, definite evidence was obtained that the relative strengths depended on the state of the tube. The weaker types, indeed, almost disappeared sometimes as the tube became hard, and flashed up again when its condition was altered. The strength of the radiation γ relative to its neighbour β altered from 70 per cent, to 90 per cent, in the course of one short experiment. Comparison between the different orders is more profitable. It will be seen from Table IV. that in ferrocyanide the third order was enormously the most conspicuous, since the general reflexion was so much less intense at these large angles. The sixth order was quite easily found, the fourth order not at all. These facts can be very simply explained. If the crystal structure completely repeats itself only every three layers, the distance between the first and fourth layers gives the fundamental distance d in equation (1). It is possible either that the three layers are at nearly but not quite the same distance apart, or that every third layer is especially rich in the heavy atoms, iron for example, which most

efficiently scatter the primary radiation. The two cases are shown diagrammatically in fig. 3. In either case the different orders will all be present, but the third order and its multiples

Fig. 3.



may well be much stronger than the others, because in the third order all the layers cooperate, while in the first order only every third layer does so. If all the layers become both similar and similarly situated, the previous third order becomes the fundamental and the others disappear. This is the case with rocksalt, for which no subsidiary orders could be found. In this case d is presumably the distance between successive layers, and this happens to be almost exactly the same as the average distance in ferrocyanide. The behaviour of selenite is similar. Here although the intensity of the first order was more than twice that of the second, the latter was the more conspicuous. The fourth order also was much more conspicuous than the third. In this case the crystal structure evidently repeats itself every second layer. This seems to offer a simple method of investigating the structure of crystals. Another way of looking at the matter, which is really equivalent, is to regard the most conspicuous order as the fundamental, and call all earlier orders "ghosts."

In the simple case of rocksalt the intensity falls off for the higher orders much more rapidly than theoretical considerations would suggest. This is doubtless due to the effect of the temperature oscillations of the atoms in the crystal. These oscillations will not affect the resolving power of the crystal, regarded for the moment as a grating, but will greatly reduce the intensity of the reflected beam. For suppose an atom displaced a distance b out of its plane. The wave scattered by this atom will have a phase difference from those of the other atoms in the plane of $2b \sin \theta \cdot \frac{2\pi}{\lambda}$ or $\frac{b}{d} 2n\pi$, where d is the distance between successive planes; so the phase deviations are more marked in the higher orders and the relative intensity greatly reduced.

The next point investigated was the length of the train of

waves which makes up a characteristic radiation. An attempt was made to find over what range of angles reflexion of monochromatic radiation occurs. The beam was restricted by 0.5 mm. slits at P and Q, and in order to reduce the general reflexion still further a 0.5 mm. slit was placed in front of the detector. The variation of the intensity of reflexion with the angle at which the radiation struck the crystal of ferrocyanide was then measured in the neighbourhood of the special angles β_3 and γ_3 . Care was taken that the reflected beam always entered the detector. The curve is shown in fig. 4. The two maxima are caused by the

Fig. 4.

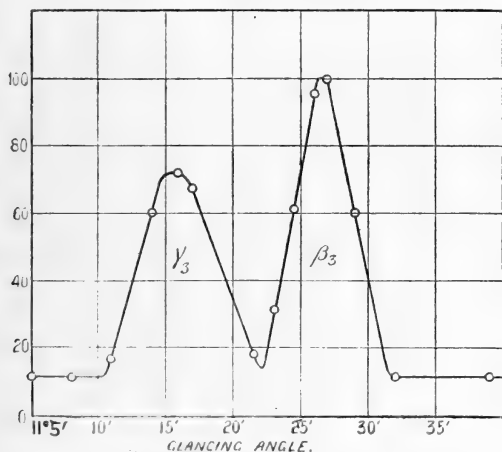

selective reflexions at β_3 and γ_3 , while the flat ends of the curve represent the general reflexion, which under these conditions was small. The shape of this curve is that which one would expect with a beam coming from a focus spot on the target not more than 0.5 mm. wide and limited by the second slit, if only those rays were reflected which struck the crystal at precisely the special angles β_3 and γ_3 . Now the characteristic rays are known to form only a fraction of the primary X-rays, and so the large intensity of the reflected beam, when the crystal is set at the special angle, shows that over a finite range of angles of incidence the characteristic rays can be reflected. This range cannot be estimated from the curve, as the exact size of the focus spot is not known, but the shape of the curve and also other experiments show that it is extremely narrow. The whole range over which reflexion can occur is certainly not more than 5', and from

this it may be concluded that these characteristic radiations are very nearly monochromatic. A mathematical treatment of this question shows that if these radiations are damped waves, the damping cannot reduce the amplitude to half value in less than 50 vibrations.

Probably the number of vibrations is really much greater than this. If it is assumed that the system which emits the characteristic radiation is a freely vibrating electron, the vibrator will, owing to its very high frequency, be appreciably damped by radiation. The equation of motion of such an electron is according to the ordinary electromagnetic theory

$$m \frac{d^2x}{dt^2} + m \left(\frac{2\pi c}{\lambda} \right)^2 x - \frac{2}{3} \frac{e^2}{c^3} \frac{d^3x}{dt^3} = 0.$$

The displacement is therefore $e^{-\sigma \frac{ct}{\lambda}} \cos 2\pi \cdot \frac{ct}{\lambda}$ where $\sigma = \frac{4\pi^2}{3} \cdot \frac{e^2}{mc^2\lambda}$ (e is the charge, m the mass of the electron, and c the velocity of light). This gives rise in the case of a radiator with the frequency of the characteristic β to a wave, of which the amplitude is damped to half value in $2680 \text{ K}^{\frac{1}{2}}$ wave-lengths. A wave damped to this extent will be reflected over a range of angles of incidence large enough to be capable of being detected experimentally. An attempt will be made to measure this range, as the matter is of great theoretical interest.

The same experimental arrangements were used to test how precisely the laws of reflexion are obeyed. The slits were far too broad to introduce diffraction in the case of radiation of such short wave-length. Attempts are, however, sometimes made to explain the corpuscular properties of X-rays by endowing them with a very restricted wave-front. If such a beam struck a crystal the scattering from the atoms would give a system of waves, of which the interference would show the same arrangement as the diffraction pattern round a small hole. The crystal was set permanently at the special angle β_3 , so that unless diffraction occurred, the reflected radiation would consist almost entirely of characteristic rays proceeding in a parallel beam 0.5 mm. wide. The opening of the detector, 0.5 mm. wide, was moved across this beam. The result showed no trace of diffraction. It was calculated that in each reflecting plane an area containing at least a million atoms must have been concerned in producing so perfect a reflexion.

Discussion of the General Reflexion.

We have seen that monochromatic radiation is reflected only at certain special angles, but that reflexion of the general radiation from an X-ray tube occurs for all angles of incidence. This shows that the general X-rays resemble white light. The primary radiation may therefore, for convenience, be imagined to contain constituents with wave-lengths varying continuously over a finite range, though, as a matter of fact, these constituents are produced by the analysing property of the crystal. These rays are sorted out into a continuous spectrum of monochromatic waves, and only those constituents are reflected at a glancing angle θ of which the wave-lengths satisfy the condition $n\lambda = 2d \sin \theta$. With the help of this condition the variation of the reflexion with angle can be predicted in general terms.

Suppose that the energy in the spectrum is largely concentrated into a limited range of wave-lengths. For very small values of θ the intensity of reflexion will be small, as only the constituents with the shortest wave-lengths will be present even in the first order. The radiation will here be exceptionally penetrating, since the absorption coefficient in aluminium increases very rapidly with the wave-length. As θ is increased the intensity reaches a maximum, which roughly corresponds with that component which has the greatest intensity in the spectrum. At greater angles the intensity falls off, and the radiation becomes continuously softer. Here the effect of the short wave-lengths reflected in the second and higher orders begins to become noticeable. Under the conditions of these experiments but few of the softer types of radiation could reach the detector. At large angles therefore the effect of the constituents reflected in the first order will become small, and the penetrating power of the radiation will no longer even approximately correspond to it. Eventually the reflected beam will consist of such a mixture of constituents reflected in various orders that its quality will become approximately constant. As the X-ray tube is softened the angle for which the reflexion is a maximum will of course become greater.

The reflexion found for rocksalt is in perfect agreement with this theory. In fig. 2, curve II., the maximum close to 4° and the very rapid decrease in intensity for smaller angles are conspicuous. For larger angles the curve falls off less steeply, and at 6° the second-order spectrum is no doubt just making its appearance. We know, however, from the experiments with monochromatic rays that the second order in rocksalt has very little intensity compared with the first.

Its effect will only become important when the constituent of which the wave-length corresponds with the first order is very weak. The steady increase in the absorption coefficient as the angle is increased from 3° to 8° , and the way in which the maximum shifts towards larger angles as the tube softens, have already been described. The effect of the different orders overlapping is very marked in the neighbourhood of the special angles α_1 , &c. Here the characteristic radiation, reflected in the first order, is stopped by a few tenths of 1 mm. of aluminium. A sheet of this thickness has, however, very little effect on the general reflexion at a neighbouring angle. In the reflexion from selenite the maximum intensity in the first order should occur at about $1^\circ.5$. In this case, however, the second order is more important than the first, so that a strong second-order effect, with maximum at about $3^\circ.0$, will be superimposed on it. The combined effect shows in curve I. a strong maximum at a rather smaller angle than would be anticipated, probably partly because a somewhat harder tube was used in this case. There is also, however, an important difference between the behaviour of monochromatic radiation and a continuous spectrum. In the latter case, owing to the increased dispersion, the second-order spectrum will be spread out over twice the range of angles occupied by the first order, and the intensity at any angle will consequently be halved. This is well shown in curves III. and IV. taken with the ferrocyanide crystal. Here the very narrow first order and the broader third order are conspicuous, while curve IV. shows also the effect of the weaker second order. At very fine angles curve IV. falls away much more than curve III., and at broader angles the reverse occurs, all in accordance with theory.

In the reflexion at small angles from rocksalt the first order predominates, and this gives an opportunity of finding the distribution of energy in the spectrum of the X-rays. The complete mathematical treatment of this question is much too long for this paper, and a simple argument which leads to the same conclusion must here suffice.

It is probable in the first place that, if no cooperation or interference took place, the amount of energy scattered from the surface of a thick sheet of any material, when struck by the X-rays, would be approximately independent of the quality of the radiation, and would be proportional to $1 + \cos^2 \phi$ where ϕ is the angle between the primary and scattered rays. The experiments of Crowther* have shown that when ϕ is small the scattering is much greater than

* Crowther, Proc. Roy. Soc. A. lxxxvi. p. 478 (1912).

this : but it has been suggested by Webster * that this excess scattering is due to an irregular attempt at cooperation between the disturbances from the different atoms. If this is so no account need be taken here of this excess radiation. For glancing angles less than 6° , the factor $(1 + \cos^2 \phi)$ is approximately constant and need not be considered. The intensity of reflexion will therefore depend on two factors: (1) the energy of the part of the incident radiation which is reflected, (2) the number of atoms of which the effects cooperate. If the components with wave-lengths between λ and $\lambda + d\lambda$ are alone reflected, their energy may be expressed as $E_\lambda d\lambda$. Now consider the number of atoms that can cooperate. This is composed of two factors A and B. A represents the number of atoms in one plane which cooperate, B the number of cooperating planes. A is evidently proportional to the area of a Fresnel zone on the face of the crystal, that is to $\lambda^2 \operatorname{cosec} \theta$. To obtain B, consider a pulse with no definite wave-length coming from a point source and limited by a slit, so that it strikes the crystal only at angles between θ and $\theta + d\theta$. Considering only first-order reflexion, components with wave-lengths between λ and $\lambda + d\lambda$ will alone be reflected. Cooperation between the reflexions from successive planes will only continue so long as the extreme components λ and $\lambda + d\lambda$ remain in step. They will be completely out of step in n layers where $nd\lambda = \frac{1}{2}\lambda$ and so the factor B is proportional to $\frac{\lambda}{d\lambda}$. The intensity of the reflected beam is therefore proportional to $E_\lambda d\lambda \cdot \lambda^2 \operatorname{cosec} \theta \cdot \frac{\lambda}{d\lambda}$, that is to $E_\lambda \cdot \lambda^2$, since by equation (1) $\lambda \operatorname{cosec} \theta$ is constant.

Now u_ν , the energy between frequencies ν and $\nu + 1$, is proportional to $E_\lambda \cdot \lambda^2$. If, therefore, this argument is based on correct assumptions with regard to the scattering, then curve II., fig. 2, gives the distribution in the spectrum of the energy of the X-rays. The maximum value of u_ν occurs at a wave-length of about $K^{\frac{1}{2}} \times 4.9 \times 10^{-9}$ cm. The potential measured by an alternative spark-gap was 50,000 volts. The curve does not show this distribution in its usual form, but u_ν is plotted against θ , which for these small angles is proportional to λ . The general form of the curve bears a striking resemblance to that of the radiation from a black body. The rapid fall of energy for high frequencies and the more gradual fall for low are very noticeable, but on both sides the rise to the maximum is much steeper than it is for the radiation from a black body.

* D. L. Webster, *Phil. Mag.* xxv. p. 234 (1913).

Summary.

1. X-rays "reflected" from crystals have the general properties of ordinary X-rays.

2. The radiation from an X-ray tube with platinum target is of two kinds, (A) radiation of indefinite wave-length, analogous to white light, (B) five types of monochromatic radiation, probably characteristic of the platinum.

3. The radiation (A) is reflected at all angles of incidence. The reflexion has been studied at different angles, and the results have been interpreted.

4. Each of the radiations (B) is reflected only at special angles. These angles have been measured with three crystals, and the results are in good agreement with the simple theory deduced from the principle of interference.

5. The wave-lengths of these radiations have been calculated to be 1.642, 1.397, 1.375, 1.194, $1.157 \times K^{\frac{1}{2}} \times 10^{-8}$ cm. where K is probably either 1, $\frac{1}{2}$, or $\frac{1}{8}$.

6. Their homogeneity has been examined.

7. An attempt has been made to estimate the distribution of energy in the wave-lengths for the general X-rays.

We wish to express our warmest thanks to Prof. Bragg for the information which he has given us from time to time about his work on this subject. This information has been of great value to us.

We also wish to thank Prof. Rutherford for the very kind interest which he has taken in our work.

XV. Notices respecting New Books.

Results of Observations made at the Coast and Geodetic Survey Magnetic Observatory near Tucson, Arizona. Washington. Government Printing Office, 1913.

TUCSON (32° 14' 8 N. lat., 110° 50' 01 E. long.) is a new magnetic station of the U.S. Coast and Geodetic Survey, taking the place of Baldwin, Kansas, which has been discontinued. The present volume describes the site, and the construction of the buildings, which were built in 1909, and gives particulars of the results obtained from the magnetographs and the principal earthquakes recorded by a Bosch-Omori seismograph down to the end of 1910. The volume resembles in its contents and the order of their presentation the biennial volumes issued for the older observatories of the Survey.

FIG. 13.

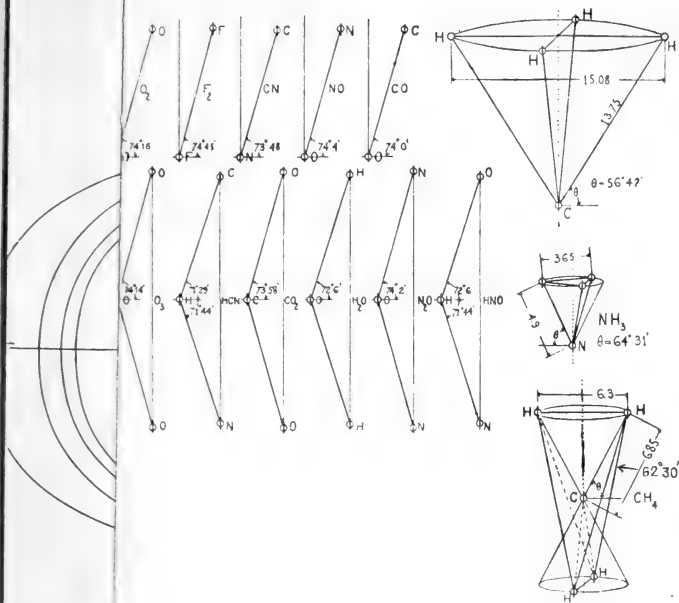

FIG. 14.

3

4

5

7

6

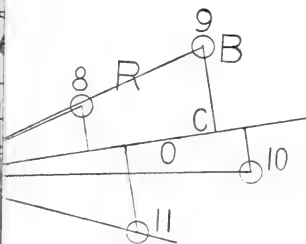

ve 7d

$11 = 7 + 4.$



FIG. 1.

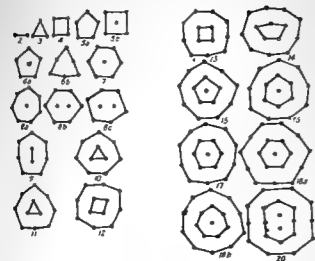

FIG. 2.

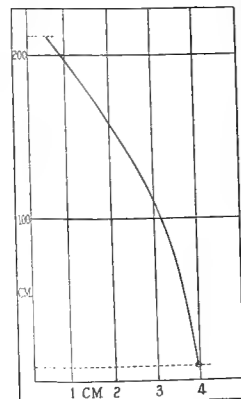

FIG. 6.

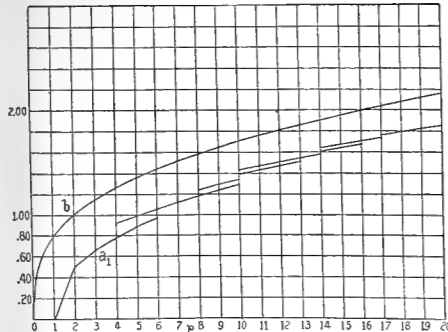

FIG. 7.

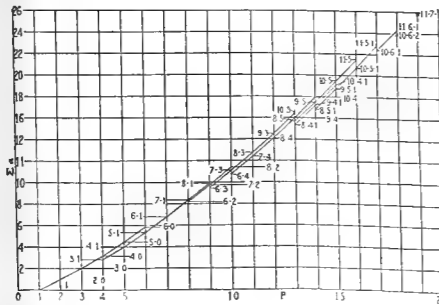

FIG. 8.

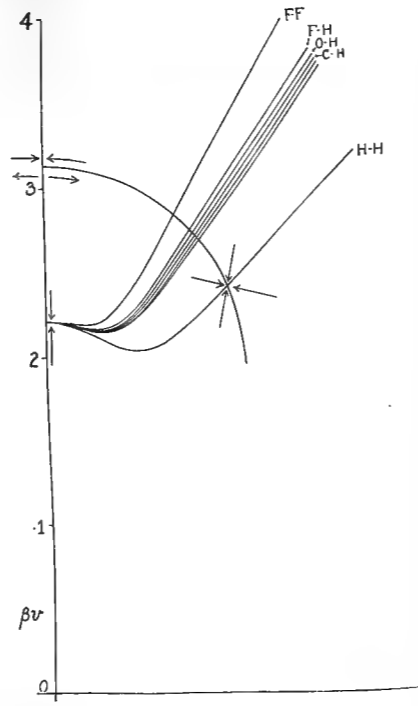

FIG. 9.

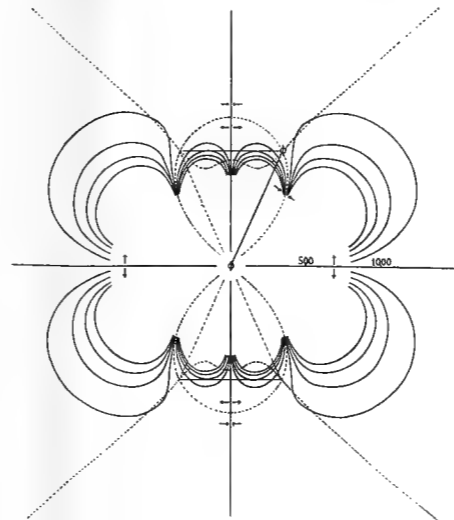

FIG. 10.

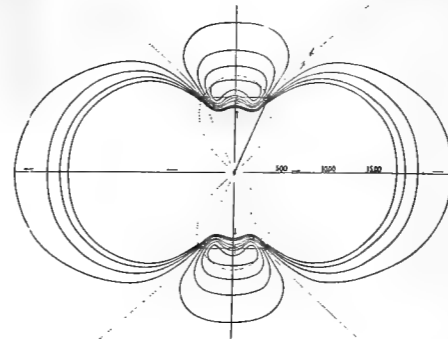

FIG. 11.

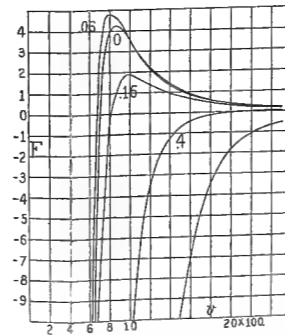

FIG. 12.

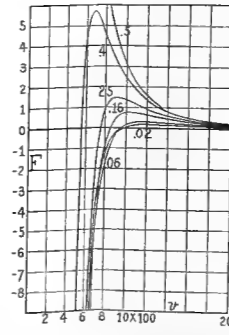

FIG. 13.

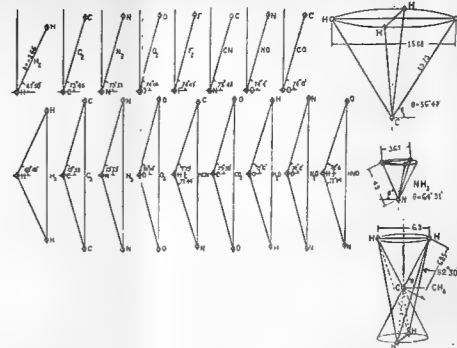
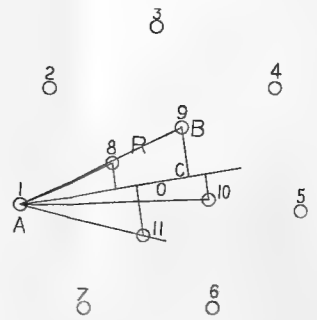
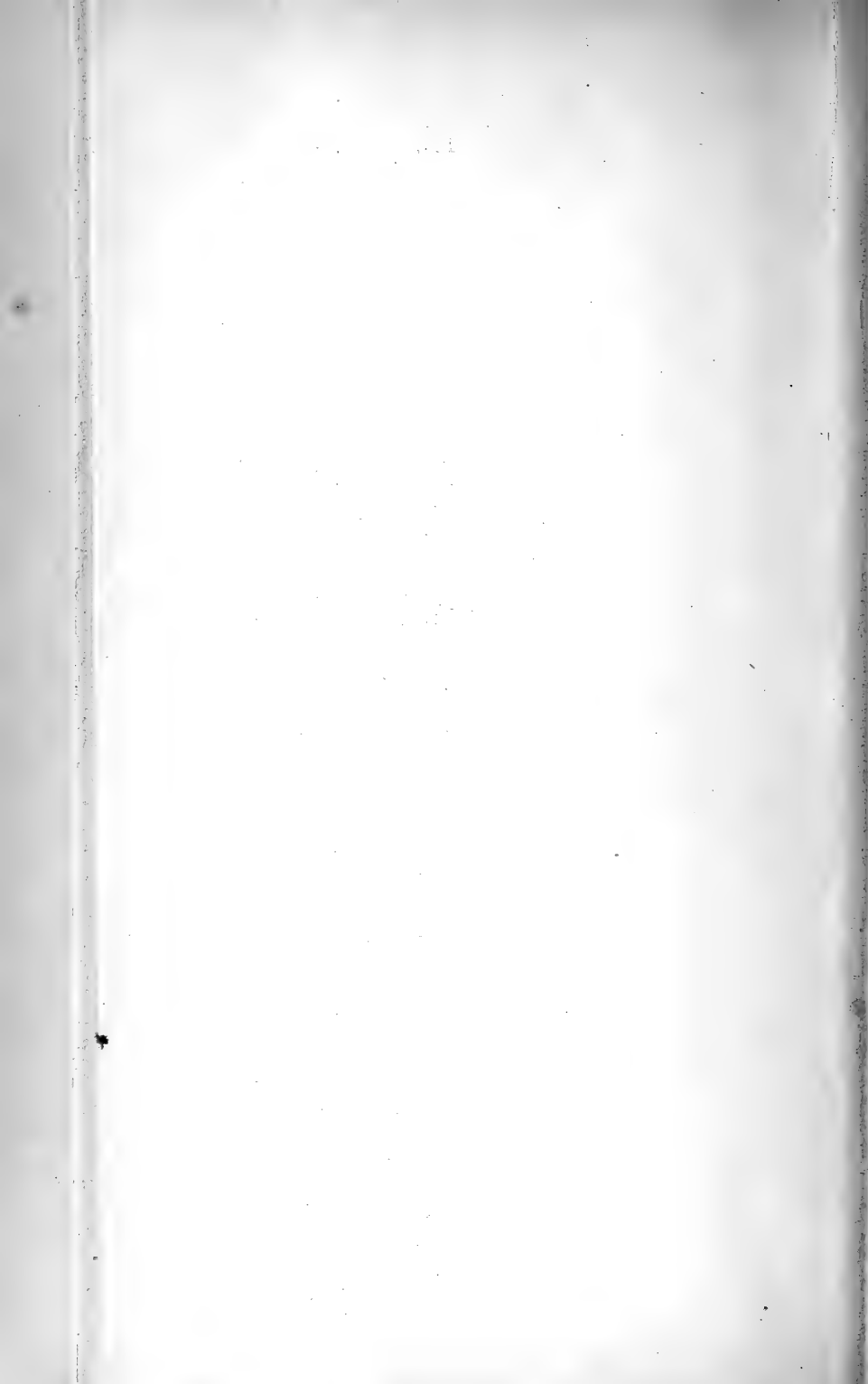

FIG. 14.



Negative 7d. 11 = 7 + 4.



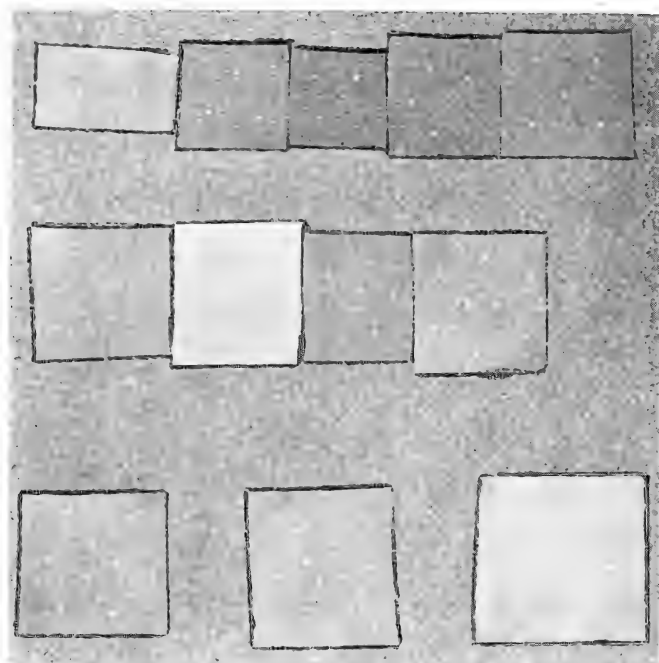

FIG. 3.—Aluminium spheres 0.607 cm. diameter suspended in air by silk fibres moistened with glycerine.

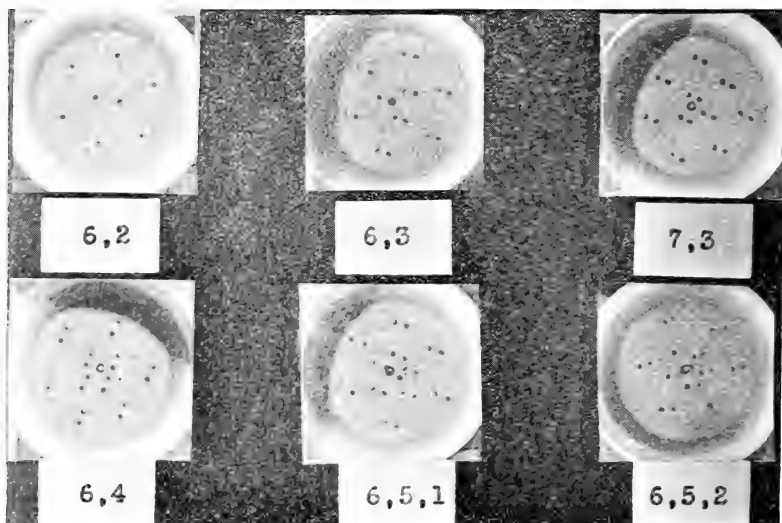

FIG. 4.—Steel spheres 0.794 cm. diameter suspended by copper wires 0.0038 cm. diameter in castor-oil. No surrounding screen.

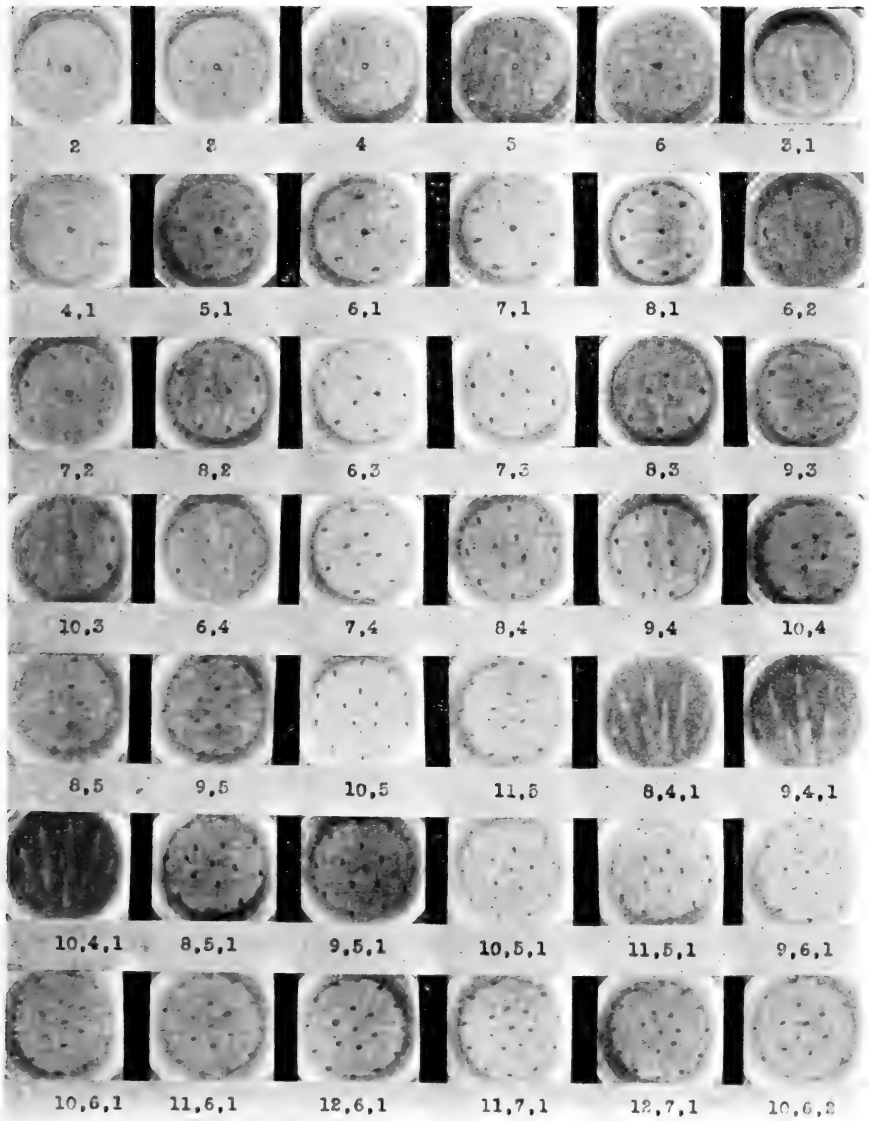
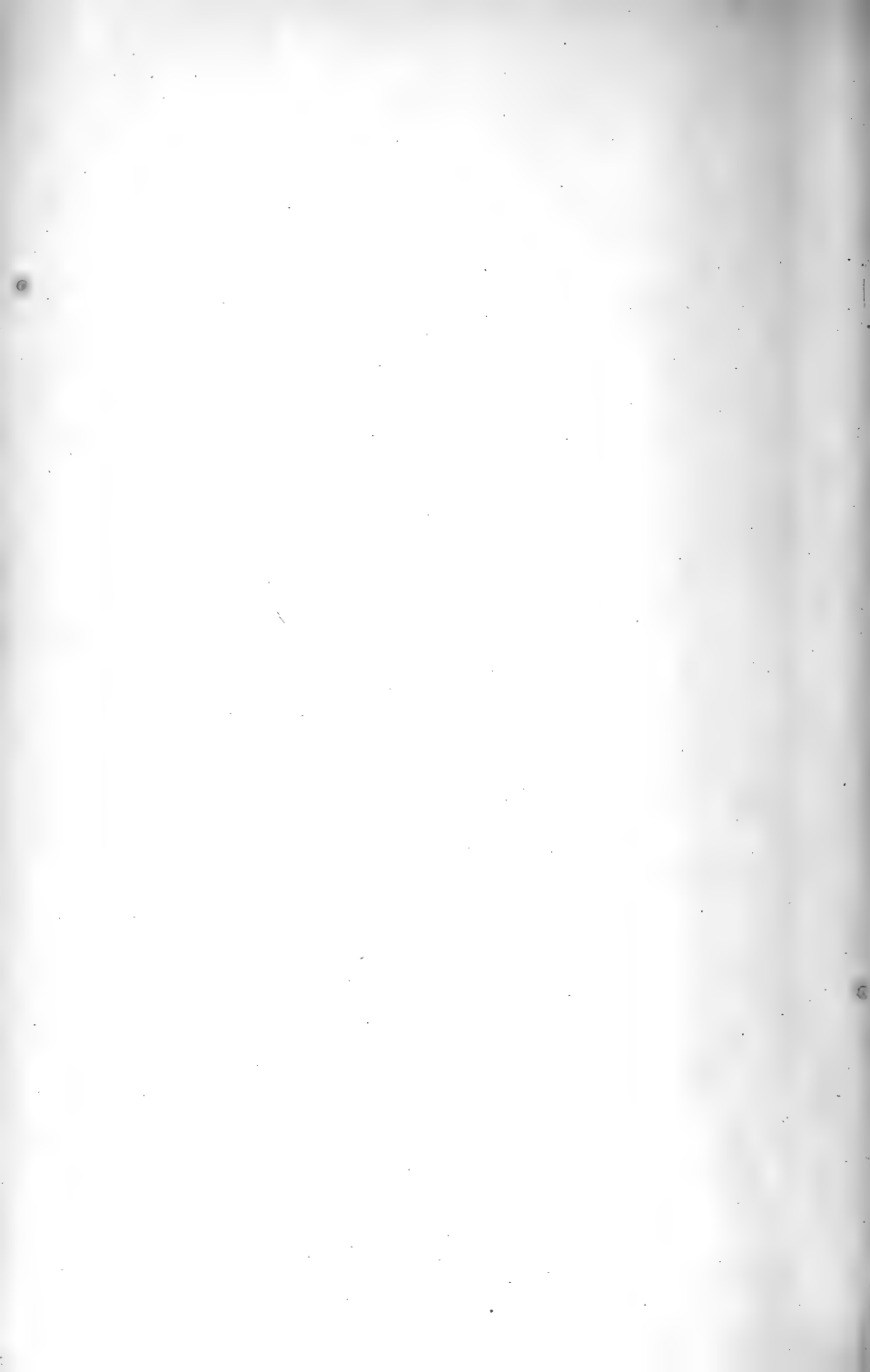

FIG. 5.—Steel spheres 0.794 cm. diameter, suspended by copper wires 0.0038 cm. diameter in castor-oil. Modified by surrounding screens.



c



v



Glac



FIG. 1.

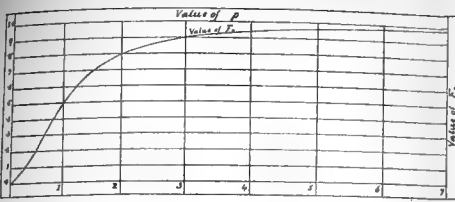

FIG. 2.

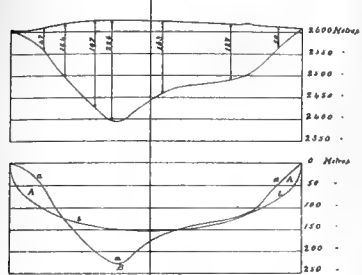
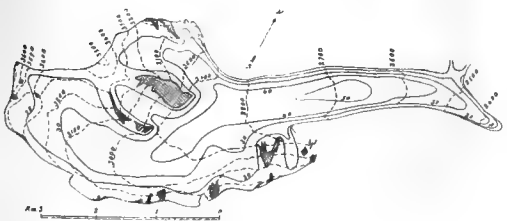
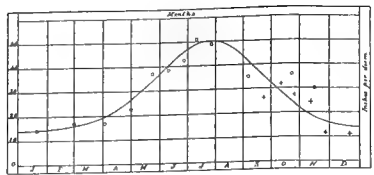

FIG. 3.



The Hintereis Glacier.

FIG. 4.



Surface Velocity of Glacier des Bois.

FIG. 5.

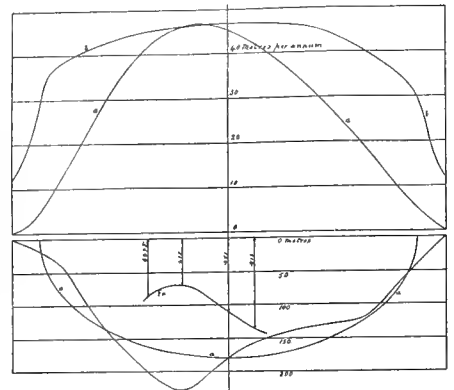

FIG. 6.

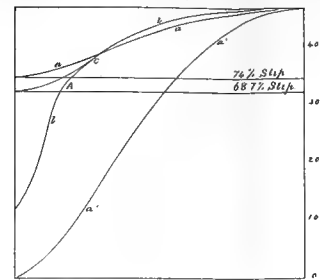

FIG. 7.

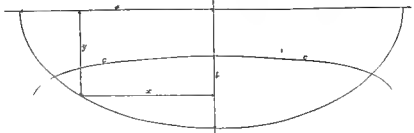

FIG. 8.

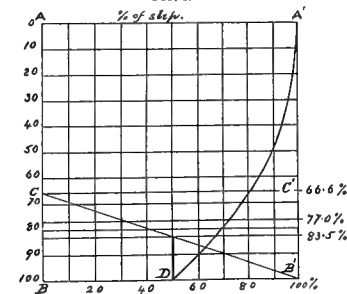

FIG. 9.

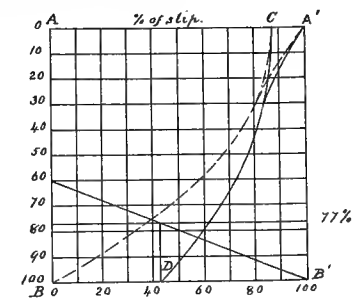
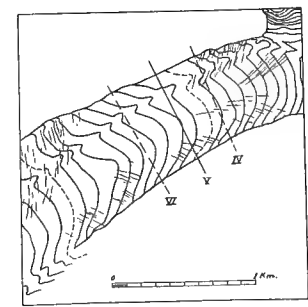

FIG. 10.



Portion of Tongue of Hintereis Glacier.

FIG. 11.

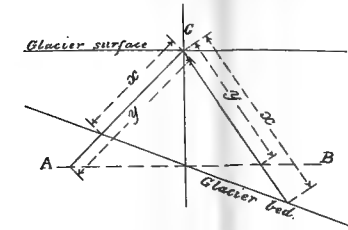

FIG. 12.

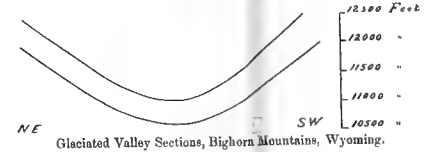
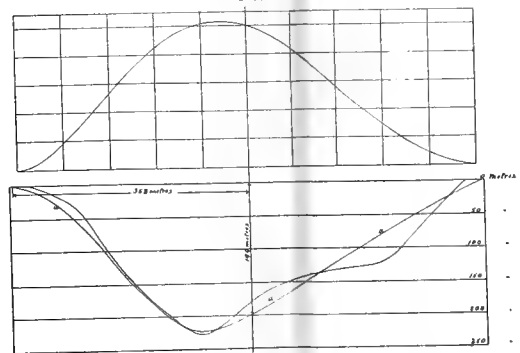
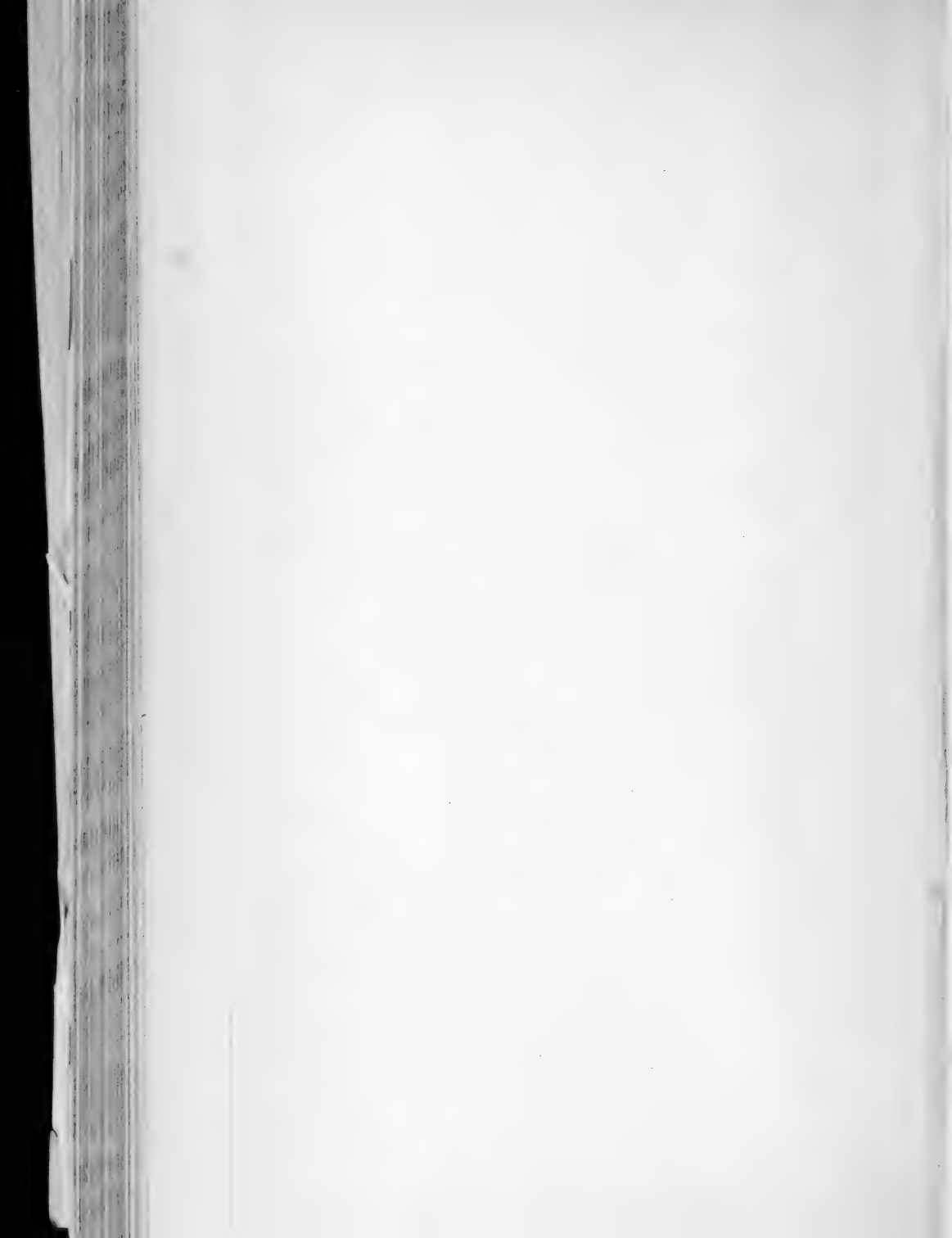
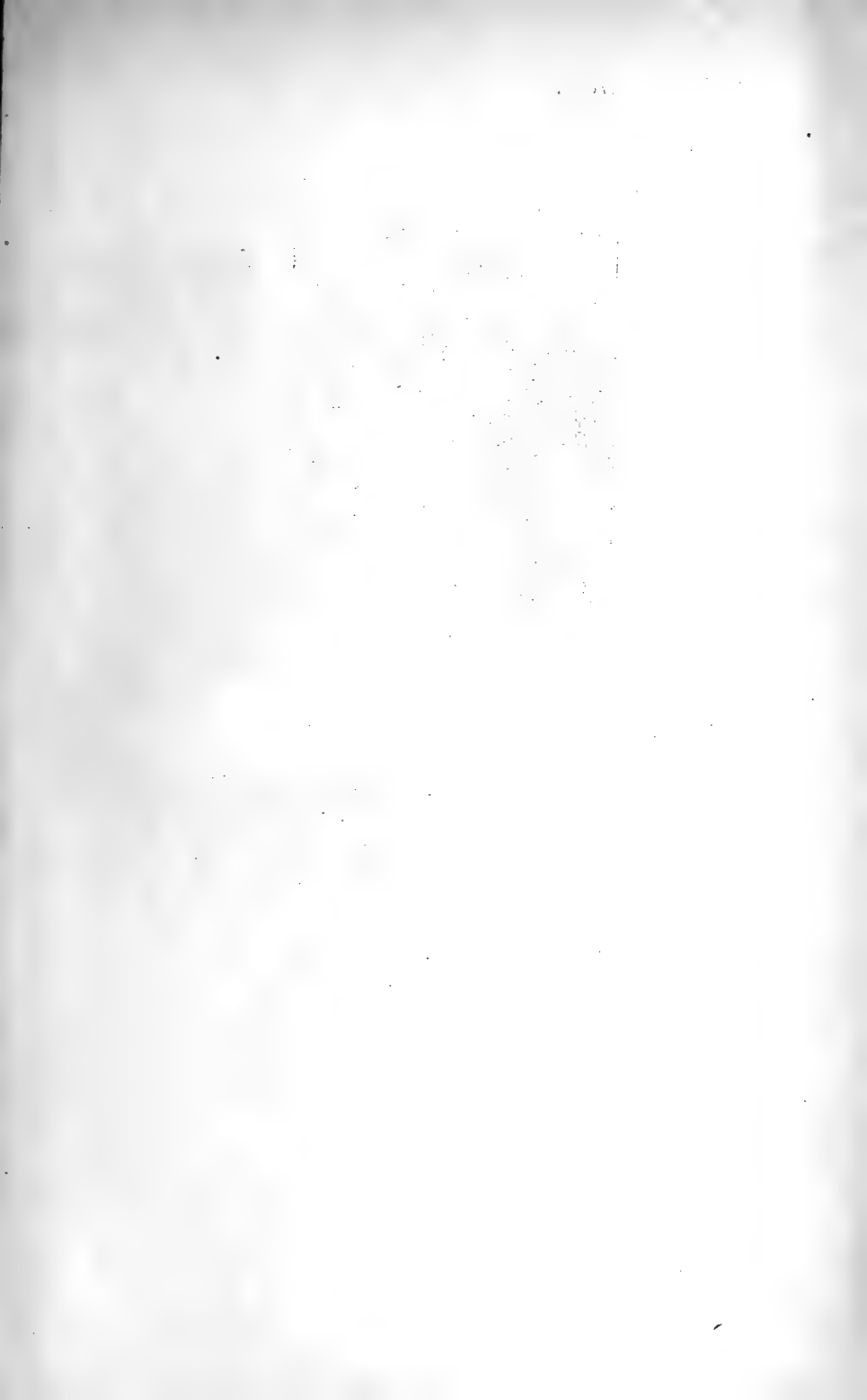

FIG. 13.



Comparison of Farris Curve with Glacier Section.







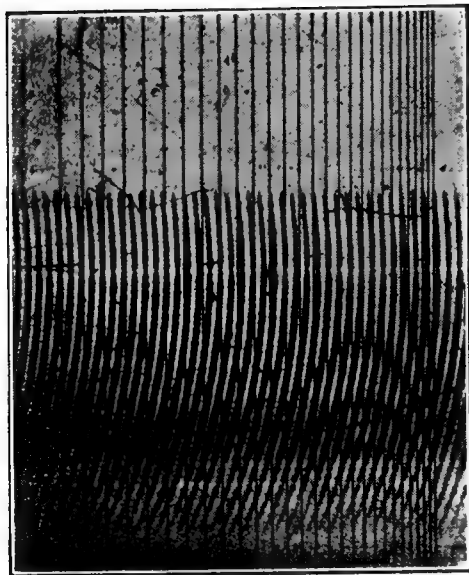

FIG. 3.

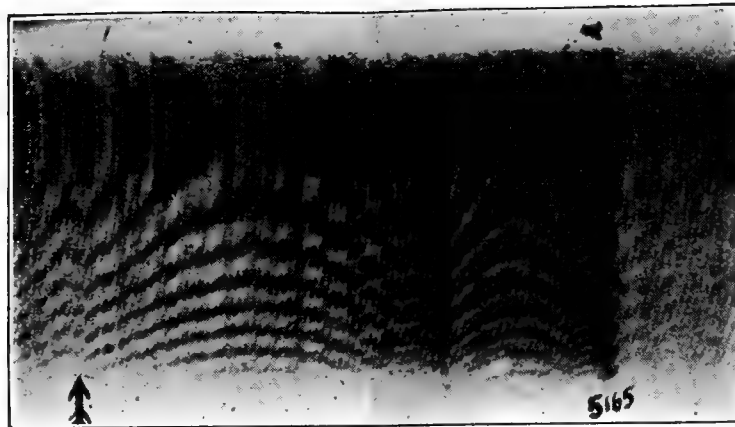

FIG. 1.

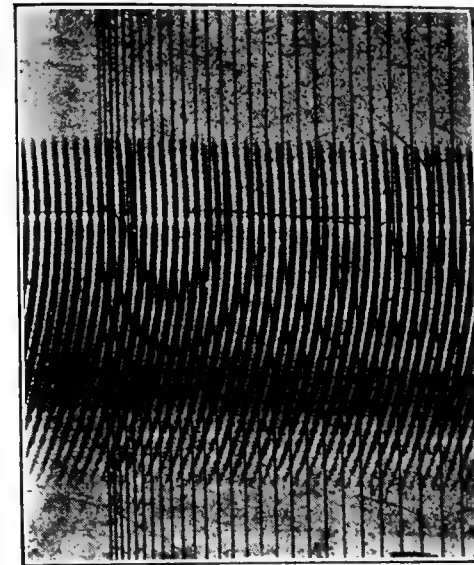

FIG. 4.

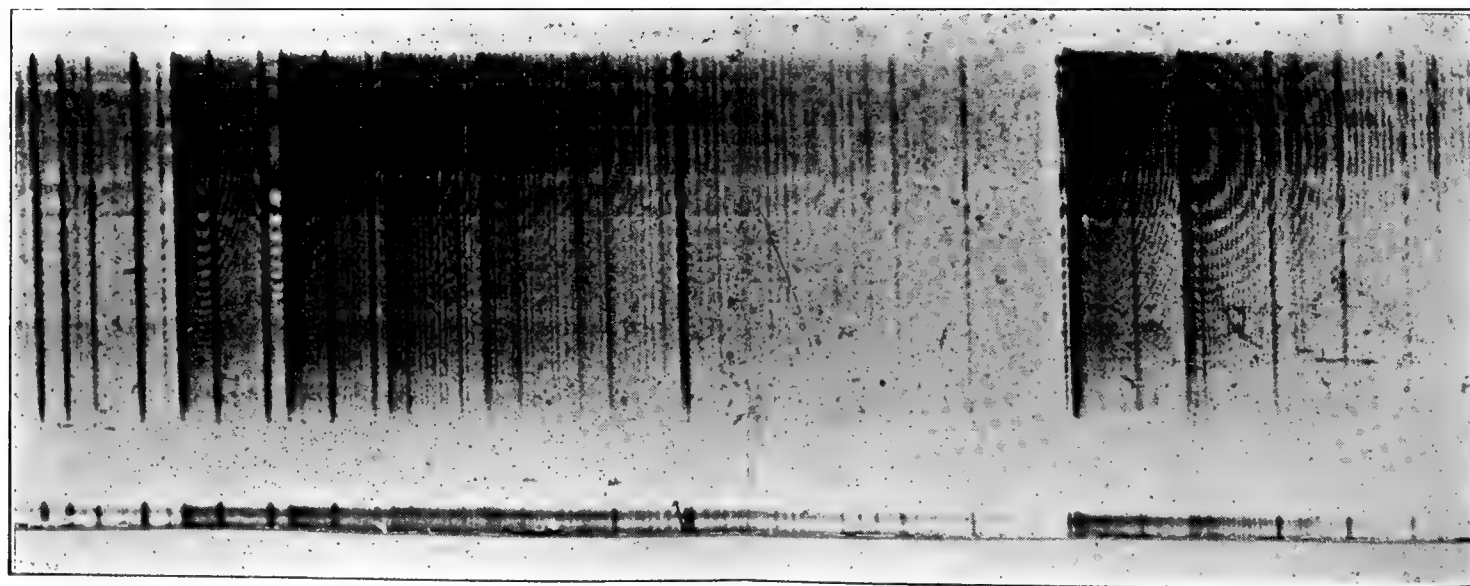

FIG. 2.



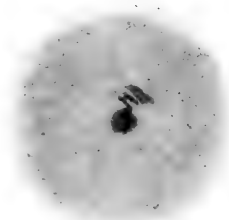

FIG. 2.

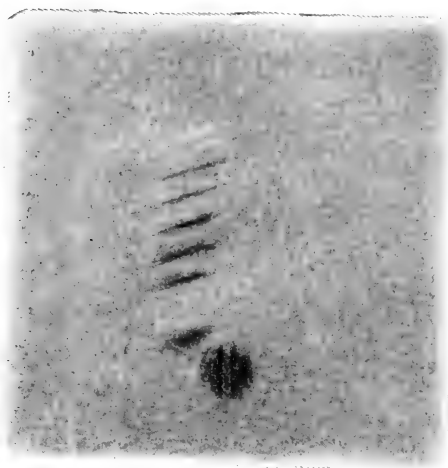

FIG. 3.

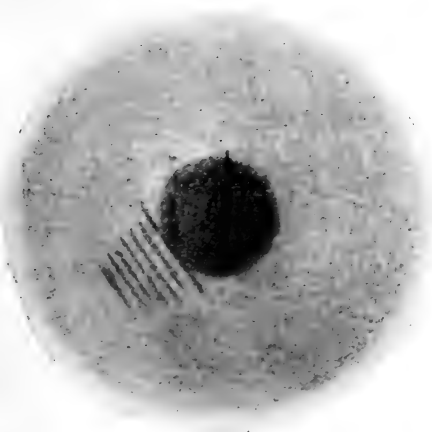

FIG. 4.

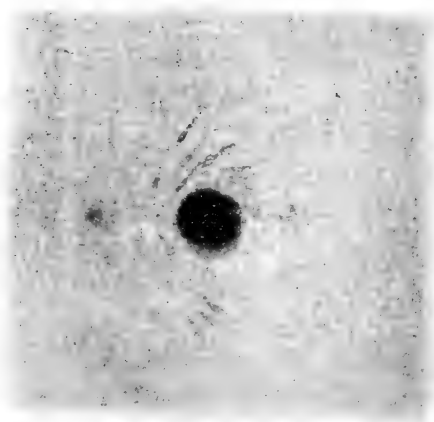

FIG. 5.

[The reflected spot for light-waves would occur in each case to the left of the main impression.]







FIG. 1.

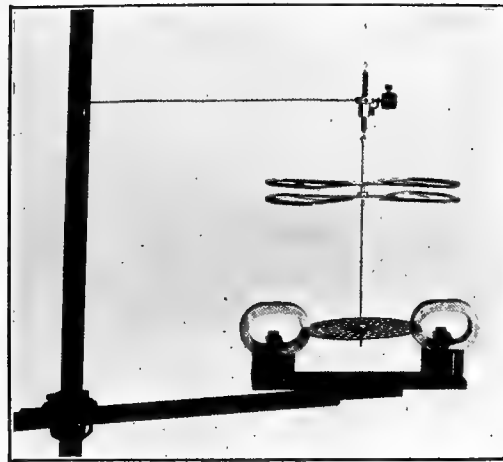

FIG. 2.

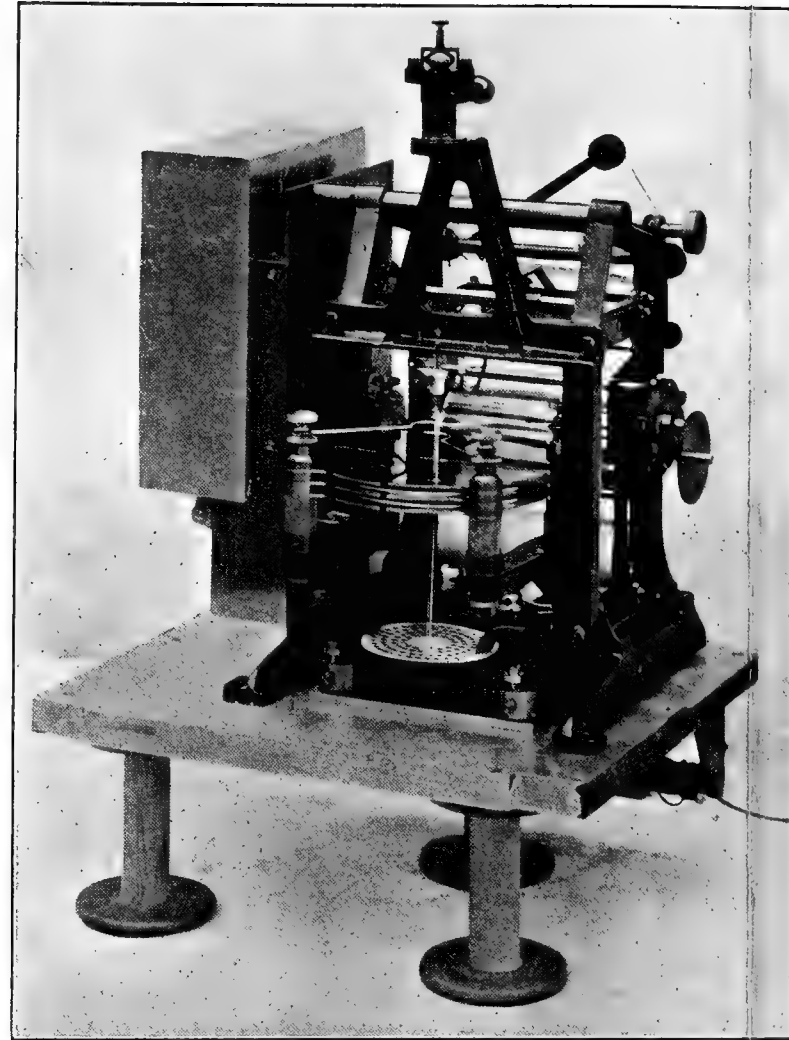
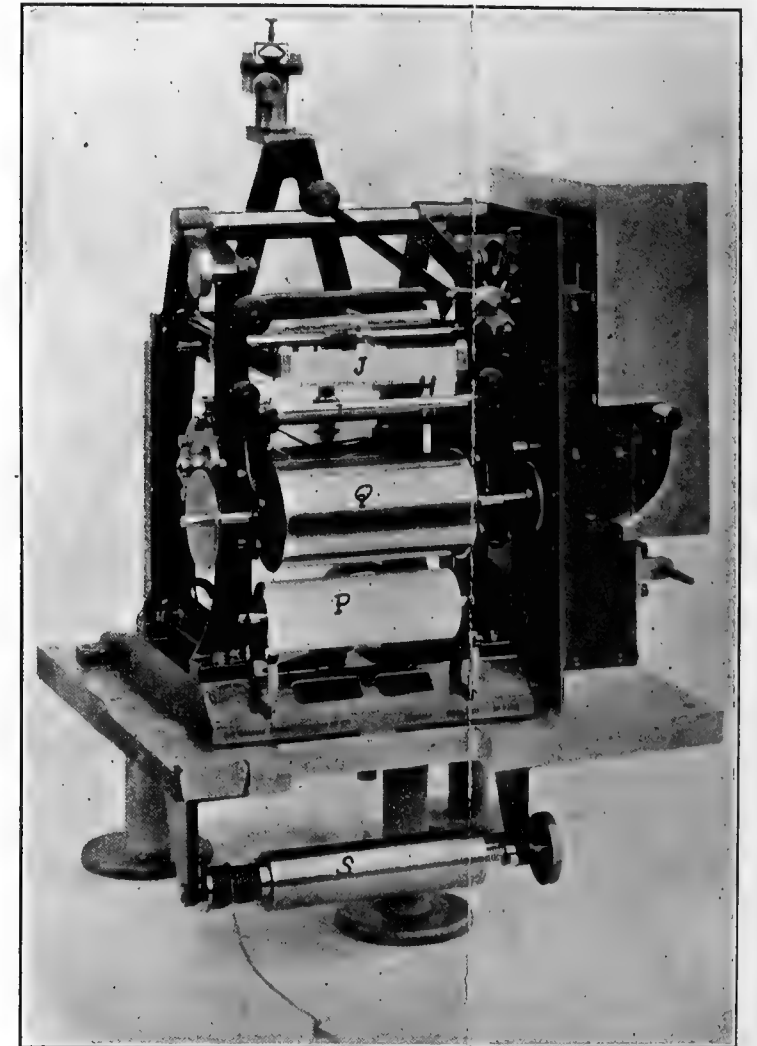

FIG. 3.





THE
LONDON, EDINBURGH, AND DUBLIN
PHILOSOPHICAL MAGAZINE
AND
JOURNAL OF SCIENCE.

[SIXTH SERIES.]

AUGUST 1913.

XVI. *On the Velocities of Delta Rays.*
By H. A. BUMSTEAD, *Yale University**.

§ 1.

THE name "delta rays" was given by Sir J. J. Thomson in 1905 to the slow electrons which he found to be emitted by polonium, and which had previously masked the positive charge of the α -rays. Shortly afterward, and independently, Rutherford discovered a similar emission from radium and showed that it was not confined to the source of α -rays, but took place from any body which was struck by them. Some writers have made a distinction between these two phenomena, restricting the name delta rays to those which are emitted by the source of α -rays and calling the others secondary rays. There appears, however, to be little ground for this distinction; there is no appreciable difference between the two kinds of rays, and everything goes to show that Rutherford was right in his original suggestion that all δ -rays are secondary phenomena, due to the impact of α -rays upon matter. In the present paper, therefore, the name will be used in this sense.

The question of the velocity of the δ -rays has been attacked by a number of investigators †. They have all agreed that a large proportion of the rays have velocities which are small,

* Communicated by the Author.

† For an historical sketch of the subject see Campbell, *Jahrb. d. Radioaktivität und Elektronik*, ix. p. 419 (1912).

as electronic velocities go, not very different, in fact, from those which are observed in the photo-electric effect. The estimates by different observers of the maximum velocity of the rays have been discordant; they have varied from zero to $3.9 \times 10^8 \frac{\text{cm.}}{\text{sec.}}$, the latter corresponding to a fall of potential of about 42 volts.

Last year it was shown by Dr. McGougan and the present writer* that electrons were present in a beam of δ -rays which had much greater velocities than any of the above estimates; an opposing potential difference of 1700 volts was not sufficient to stop all of them, and very marked effects were produced by electrons having velocities corresponding to several hundred volts. The present paper contains the results of some further experiments upon these swifter rays. It will be seen that there is no gap between the swifter and the slower electrons, but that all intermediate speeds are found between the highest and the lowest. It seems reasonable, therefore, to include under the name "delta rays" all the electrons which are projected from the atoms of bodies by the direct action of the α -rays, the recently discovered swift ones as well as the slower ones previously known; this nomenclature will be adopted in the present paper. It is however to be observed that some, at least, of the slower electrons (under 10 volts) must be caused, not directly by the α -rays, but by the swifter δ -rays. When there is occasion to refer to these they will be called *tertiary rays*. It is impossible at present to make a sharp distinction between the slower δ -rays and the tertiary rays which come from the source of δ -rays, or to determine the proportion of each; so that in all numerical estimates the tertiary rays must be included among the δ -rays.

§ 2.

Tertiary electrons are emitted also by any body on which δ -rays fall, and in numbers considerably in excess of the swifter δ -electrons which cause them. When an electric field is used to hold back the slower δ -electrons, this is the most conspicuous effect of the remaining swift rays; for the field which opposes the δ -rays assists the tertiary electrons to escape, and their larger number magnifies the experimental effect. The unsuspected presence of this phenomenon has undoubtedly had an influence upon the results obtained in

* Bumstead and McGougan, *Phil. Mag.* xxiv. p. 474 (1912); *Am. Journ. Sci.* xxxiv. p. 309 (1911).

previous experiments upon δ -rays, and helps to explain the discrepancies which have appeared in the work of different investigators.

Unfortunately this effect, which is easy to observe and measure, does not lend itself readily to a quantitative study of the swifter δ -rays. The number of secondary electrons, due to a single incident electron, varies markedly, and not in a very simple way, with the speed of the latter*. In a beam of δ -rays one has a complex of electrons of many different speeds, and when the opposing electric field is, for example, increased, the slower of these are eliminated and all the remaining ones have their velocities reduced; under these circumstances it appears quite impossible to draw any conclusions as to the variation in the number of incident δ -rays from observations upon the tertiary electrons.

In attempting to determine the distribution in velocity of the swifter δ -rays, the essential thing, therefore, is to eliminate the effects due to the tertiary electrons. The first method by which I attempted to do this was to receive a beam of δ -rays in a Faraday cylinder, the whole arrangement being in a very high vacuum. Two different forms were tried for the source of the δ -rays (A and B, fig. 1). In both of these the α -rays

Fig. 1.

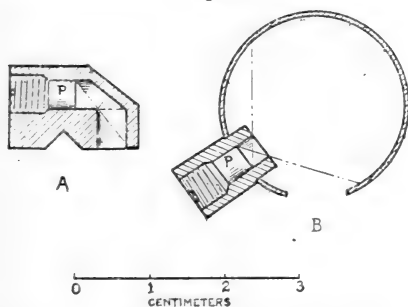

from the polonium, P, struck the inner walls of a small brass chamber; a hole in this chamber was placed so as to allow some of the δ -rays to escape but none of the α -rays. The beam of δ -rays issuing from this hole was caught in a Faraday cylinder after passing through an opposing electric field; there were suitable diaphragms and earthed screens about the Faraday cylinder. But although I had approximately a millicurie of polonium, the arrangement was not sensitive

* Gehrts, *Ann. d. Phys.* xxxvi. p. 1000 *et seq.* (1911).

enough to do more than indicate the presence of the swifter rays, certainly not to measure them. Only a small fraction of the δ -rays generated in the chamber escaped through the hole, and, even so, the beam was so divergent that the Faraday cylinder had to be rather large (5.5×4 cm.); thus its electrostatic capacity was considerable, and one could not gain any advantage by substituting a sensitive electroscope for the quadrant electrometer.

The next attempt was by insulating the source (either A or B) from the case and connecting it to the measuring instrument; as its capacity was small, an electroscope could now be used to advantage. A negative potential applied to the case would send back to the source all the electrons whose kinetic energy was not sufficient to overcome the opposing potential difference. Here the difficulty was to prevent the tertiary electrons, set up by the impact of the δ -rays upon the case, from being carried to the source by the electric field. I first tried to obviate this by means of a magnetic field. A long cylindrical case was used (the one shown in fig. 2), with the source of δ -rays near the top and the rays striking the bottom and the lower part of the sides of the case. A magnetic field of about 50 gauss was applied to this part of the case. To prevent this field as much as possible from having an effect upon the emission of the δ -rays themselves, the source was enclosed in a sort of upper chamber made of a plate and a ring of soft Norway iron, 1.5 cm. thick (this is not shown in fig. 2). A tapered hole in the plate allowed the beam of δ -rays to pass into the lower chamber; both chambers were coated with soot. Preliminary measurements of the magnetic field in the upper chamber by means of a swinging needle showed that, with a field of 50 gauss near the bottom of the case, the field near the source was not more than 0.5 gauss.

This method was not wholly unsuccessful. In a charcoal vacuum which had been maintained for several days, the source lost negative electricity in the face of an opposing potential of 300 volts, but beyond that it acquired a negative charge. The form of the relation between current and potential for the lower voltages was quite similar to those obtained later with the final form of apparatus; with potentials over 250 volts, however, the effects of the tertiary electrons began to be conspicuous. Moreover, on account of the limited beam of δ -rays the values of the currents were small and necessitated the use of a very sensitive, and consequently troublesome, electroscope.

§ 3.

The final form of the apparatus is shown in fig. 2. The source of δ -rays is the shallow, open, cylindrical box, B, made of brass; in some of the later experiments, in which a magnetic field was used, the box was surrounded by a flat ring of brass, as shown in the figure, giving to the source

Fig. 2.

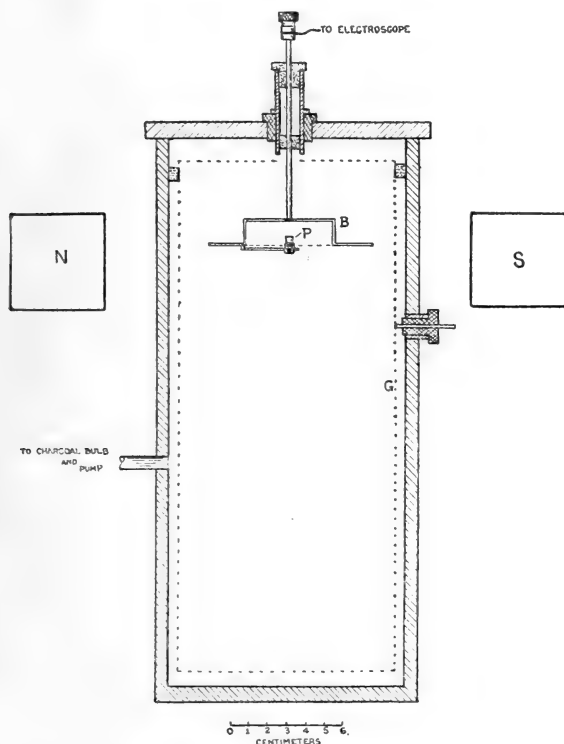

the shape of a sailor's hat. Below, and opposite the middle of this box, a thin brass arm supported a cylindrical copper plug, P, with a deposit of polonium on its upper surface, which was 4 mm. in diameter*. The end of this plug projected into the box so that none of the α -rays escaped, but fell upon the top and sides of the box; the open character of

* I am again indebted to Professor Boltwood for the polonium used in these experiments. For three successive years he has most kindly supplied me with the annual crop of polonium grown from a preparation of radiolead in his possession.

the latter and the smallness of the obstacle presented by the polonium and its support enabled a large proportion of the δ -rays and tertiary rays to get away. This source was enclosed in a large cylindrical brass case which could be highly exhausted by the help of charcoal and liquid air; the charcoal bulb was placed between the evacuated chamber and the pump and gauge, and was so constructed as to free the chamber from mercury vapour by its distillation into the cold bulb. Within the case and $\frac{1}{2}$ cm. from its walls was a cylindrical cage of bronze wire-gauze which was insulated from the case and could be separately charged by means of an external electrode. It was found to be important that the insulators supporting the cage should not be struck by the δ -rays; if they were, they acquired charges which gave rise to erratic results. Accordingly the cage was supported by three small pieces of ebonite near the top, and out of the path of the δ -rays. The gauze had 5.5 meshes to the centimetre; of its entire area 83 per cent. was open, the remaining 17 per cent. was occupied by the wires.

The rod which supported the source, B, was insulated from the case and provided with an earthed guard-tube in the usual manner. It was connected to the gold-leaf of a sensitive electroscope of the Hankel type which has been previously described*. The magnitude of the effects obtained, even when all the slower δ -rays were stopped, was such that the electroscope could be used at the very moderate sensitiveness of 200 divisions per volt. Under these circumstances the deflexions were strictly proportional both to potential and current over the whole range of the eyepiece scale in the microscope (100 divisions); the sensitiveness remained quite constant, so that there was no need of continual checking up by means of a potentiometer. When changes in the zero position occurred, they were slow and steady and could easily be taken into account, and they caused no alteration in the sensitiveness; often the zero would not vary more than one or two divisions in an entire half-day's work †.

On account of the emission of δ and tertiary rays, the source as soon as it is insulated acquires a positive charge which increases with the time. When there is no opposing

* Bumstead, *Phil. Mag.* xxii. p. 910 (1911); *Am. Journ. Sci.* xxxii. p. 403 (1911).

† In order to secure fair steadiness of the zero reading, it is necessary to protect any sensitive electroscope against sudden changes of temperature. With the electroscope mentioned satisfactory protection is given by covering it with felt about $\frac{1}{4}$ inch thick, and by setting it up in a wooden box (with an open front), to keep off draughts in some degree. A glass window in the back of the box admits light to the gold-leaf.

field this charge is far too great to be measured with the arrangements described above. When the case and cage are both charged to the same negative potential, all the electrons, whose kinetic energy is less than the work which this potential can do upon an electron, are returned to the source and only the swifter ones escape; thus the rate at which the source acquires a positive charge is diminished. When, however, the negative potential applied to the gauze and case is more than about 25 volts, the source begins to acquire a *negative* charge, which (as the negative potential is increased) soon reaches a maximum and then steadily decreases; this continues up to, and beyond, 2000 volts. This effect has been shown to be due to the emission of tertiary electrons by the case when struck by the swifter δ -rays; the tertiary electrons are returned to the source of δ -rays by the field, and, as they exceed in number the δ -rays which produce them, the source acquires a resultant negative charge, which falls off, however, as more and more δ -electrons are restrained from reaching the case*.

It was for the purpose of eliminating, if possible, this complication that the wire-gauze cage was introduced as a substitute for the magnetic field mentioned in § 2. Retarding fields may be set up by putting negative potentials on the gauze while the case is kept grounded. As the tertiary electrons have small velocities, those which are set up at the surface of the case, by the δ -electrons which have surmounted the field and passed through the meshes of the gauze, will not get back to the source on account of the field between the gauze and the case†. The electric force is much greater between gauze and case than between gauze and source (though the potential difference is the same) because of the smaller distance; thus a considerable fraction of the tertiary electrons which originate on the wires of the gauze itself will be captured by this field and will not get to the source of δ -rays. As the case and source are always kept at zero while the potential of the gauze is changed, the *shape* of the lines of force, in the neighbourhood of the wires of the gauze and within its meshes, will not change, and it seems reasonable to assume that a nearly constant fraction of the tertiary rays originating upon the gauze will be captured in this way, and that the number which get back to the source in any case will be a small part of the total set up by the δ -rays on case and gauze together.

* Bumstead and McGougan, *l. c.* § 3.

† This method has been several times used to prevent the reflexion of slow electrons in experiments upon cathode rays and on the photoelectric effect. v. Baeyer, *Phys. Zeitschr.* x. p. 174 (1909).

§ 4.

With the case grounded and with various negative potentials on the gauze cage, readings of the electroscope gave the charge acquired by the source in a given time, usually one minute. It was soon evident that the readings thus obtained varied greatly with the time which had elapsed since the production of the vacuum. Three hours after the liquid air had been applied to the charcoal bulb, a negative potential of 40 volts on the gauze was sufficient to give a slight negative charge to the electrode (the source of δ -rays, B, fig. 2); and larger negative potentials caused a marked increase in this negative current. (See Curve I, fig. 3.) As time went on, however, these effects were much altered; positive currents were observed with negative potentials on the gauze greater than 300 volts, and the negative currents at the higher potential were much diminished in magnitude. The results of four series of observations are given in Table I., and shown graphically in fig. 3.

TABLE I.

Volts.	I (3 hrs.).	II (22 hrs.).	III (46 hrs.).	IV (66 hrs.).	II-I.	III-I.	IV-I.
- 40	- 0.3	+63.6	+72.7	+76.	63.9	73.	76.3
- 80	-39.7	+21.5	+33.	+34.5	61.2	72.7	74.2
-120	-54.7	+ 8.3	-18.	+20.5	63.0	72.7	75.2
-160	-61.3	+ 1.4	+10.	+13.5	62.7	71.3	74.8
-200	-67.5	- 3.5	+ 6.	+ 9.	64.0	73.5	76.5
-240	-70.	- 6.2	+ 1.7	+ 5.5	63.8	71.7	75.5
-280	-10.	- 1.0	+ 2.8
-320	-74.	-10.7	- 2.8	0.	63.3	71.2	74.
-360	-13.4	- 1.
-400	-78.4	-14.5	- 7.	- 3.	63.9	71.4	75.4
-440	-16.	- 4.
-480	-82.2	-17.8	- 9.	- 6.	64.4	71.2	76.2
-520	-79.7	-19.6	- 7.	60.1	72.7
-560	-21.4	-11.	- 8.
-600	-22.2	- 9.
-640	-85.	-21.5	-13.2	-10.5	63.5	71.8	74.5

In the table the first column gives the negative potentials applied to the gauze cage; the second, third, fourth, and fifth give the currents (in arbitrary units) observed at 3, 22, 46, and 66 hours, respectively, after the application of the liquid air; the remaining columns give the differences between these currents.

It will be observed that these differences are constant, and that the four curves of fig. 3 have the same form and are merely shifted vertically on the diagram. It is quite clear

that we have here the resultant of two effects, the first independent of the time since the vacuum was made, and depending upon the applied potential, while the second is independent of the potential, but does vary greatly with the time. The

Fig. 3.

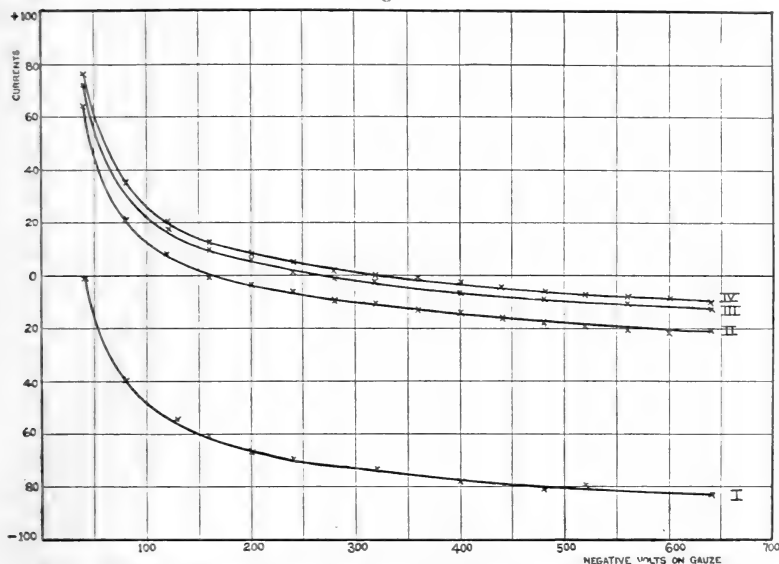

first effect is plainly due (at least in great part) to the escape from the source, B, of the swifter δ -rays, thus giving it a positive charge, which is decreased as larger opposing potentials are applied to the gauze. The second phenomenon causes the source to gain negative, or to lose positive, electricity at a rate which is independent of the potential beyond 40 volts; and its variation with the time shows that it must be due to residual gas—either that which occupies the volume of the chamber, or that which is condensed upon its walls and on the electrode.

It seemed desirable first to investigate the nature and cause of the second effect. When the apparatus was in the condition which gave the upper curve (IV) in fig. 3, the liquid air was removed from the charcoal, and a small quantity of air admitted to the chamber so that the pressure rose to 0.2 mm. This was allowed to remain for about 15 minutes, when exhaustion was recommenced, while the charcoal bulb was heated in the usual manner. When the pressure had fallen to .003 mm., the liquid air was again applied. Three hours later a series of measurements was taken, the results of which were between those represented in Curves II and III, fig. 3.

This shows that the effect in question is not due to a volume ionization of the residual gas. For the amount of gas in the chamber three hours after the application of the liquid air could not have been very different from that which was present when Curve I was taken. On the other hand, the surface films on the metals might well be different after a brief exposure to a pressure of 0.2 mm. from what they were after a prolonged exposure to atmospheric pressure. In another experiment, air at atmospheric pressure was allowed to stand in the chamber for two days; upon re-exhaustion, the same behaviour was observed as that shown in fig. 3. It seems clear therefore that the effect is due to the presence of surface films which are removed only very slowly in a high vacuum and probably not completely removed in any case.

The next question to be considered was whether the negative charge upon the electrode was due to electrons coming to it from the gas film on the case and gauze or to positive ions lost by the film on the electrode itself. To determine this a magnetic field was employed. The core of the magnet was a bar of soft iron 2 inches square in section, bent so as to form three sides of a rectangle. One side of this rectangle, 21 cm. long, was surrounded by the magnetizing coil; the other two sides, 18 cm. long, embraced the case, as shown in fig. 2, and formed long, narrow pole-pieces. Along these pole-pieces, from their ends nearly to the magnetizing coil, the field was fairly uniform, not varying more than 10 per cent., when measured by a fluxmeter. In the other two directions at right angles to this, the variation of the field was rapid on account of the spreading out of the lines of force in the large air-gap. With a current of 5 amperes, for example, the field near either pole-piece was 530 gauss, while half-way between them, and in their plane, it was 250. The field at any one point was nearly proportional to the current in the coil from 1 to 8 amperes. Before using the magnetic field, the brass box which served as the electrode and the source of δ -rays was provided with the brass ring shown in fig. 2 (forming the brim of the "hat"), which had not been present in the preceding experiments. Its purpose was to catch the δ -electrons originating near one side of the box when they were bent by the magnetic field toward that side. The addition of this ring, by increasing the capacity of the electrode, decreased somewhat the readings of the electroscope.

With the magnetic field, the electrode charged up negatively, the rate reaching a maximum value with a current of 3 amperes on the magnet and not changing when the current

was increased to 9 amperes. It was independent of the potential applied to the gauze from -40 volts to -1200, but it did vary with the time after the vacuum was made in the same manner as the results obtained previously. For example, with -40 volts on the gauze, and a magnetic field of 250 units, the following values of the current were obtained at different times after the application of the liquid air to the charcoal:—

1 hour	126	divisions	per	minute.
3 hours	72	"	"	"
24 "	25	"	"	"
48 "	12	"	"	"
72 "	9	"	"	"

We are, I think, justified in concluding that the carriers of this current are not electrons, but ions of atomic mass. Thus, in a magnetic field of 250 gaussess, an electron whose velocity was as great as that corresponding to 1600 volts would be curled into a circle of only half a centimetre radius, and could scarcely reach the electrode, even if it started from the case with that velocity; and there is no evidence that any swift electrons start from the case at all. On the other hand, a hydrogen ion whose velocity was due to a fall of potential of only 9 volts would move in a path whose radius of curvature is 1.7 cm., and might escape from the electrode, while an oxygen atom with a single charge certainly would, as its radius of curvature would be 6.7 cm.

Assuming, then, that the negative current is carried by such positive ions from the gas film upon the source, it seems unnecessary to suppose that they are emitted with an appreciable velocity, as any of the electric fields used in the preceding experiments would be sufficient to take them through the magnetic field. It seems more probable that it is simply an ionization of the gas film by the α -rays. When the current in question is reduced to its minimum value by three or four days duration of the vacuum, the charge carried by it is from 5 to 10 per cent. of that carried by all the α -rays from the polonium (see § 6). If the ions have lost a single electronic charge, this means that only one out of ten (or one out of five) of the α -particles, in its passage through the surface film, produces a positive ion which can get away. When the surface film is not so much reduced by long exposure to a high vacuum, this number is considerably greater.

It is possible that negative ions of atomic size may also be produced, but the present apparatus is not adapted to decide

this question for the following reasons. The magnetic field is by no means parallel to the electrode, and some of the lines of force meet the surface of the electrode, though not at very large angles. A small proportion of the δ -electrons from any point of the electrode will leave in paths making only a small angle with the magnetic field, and will hence escape. Now when a positive potential is applied to the gauze, the current of electrons leaving the source without a magnetic field is more than 500 times the ionic current under consideration. If a fraction of one per cent. of these escape along the lines of force, it will be sufficient to cover up the possible small current due to negative ions. That this is the case will be seen in the following section.

Effects have been observed by other investigators which, I believe, indicate the presence of ions from gaseous surface films. Thus in the recent, very careful determination by Danysz and Duane* of the charge carried by α -rays, the screen which limits the beam of α -rays and the opening of the Faraday cylinder which receives them are both covered with thin aluminium foil, the two foils being parallel and 0.8 cm. apart. A magnetic field of 8000 units parallel to these foils is used to curl up the β - and δ -rays. Even with this field, the authors found† that a difference of potential of only 2 volts between the foils increased the charge received by the Faraday cylinder by 2.5 per cent. or diminished it by 0.8 per cent., according to the direction of the electric field; a potential difference of 1800 volts, they find, may affect the current as much as 8 per cent. It is very difficult to believe that these results can be due to a "drift" of the δ -electrons as the authors suppose; in their magnetic field, the radius of curvature of the path of an electron, moving with a velocity corresponding to 2 volts, would be about 0.005 cm.; with a velocity corresponding to 1800 volts about 0.2 cm. In neither case does it seem possible that an electron would be able to traverse the 0.8 cm. between the two foils. In fact, with 2 volts, it appears that it would require a very heavy ion to get through the magnetic field; with 1800 volts, an oxygen ion should get through.

§ 5.

An estimate of the reliability of the present measurements of the distribution in velocity of the swifter δ -rays will be facilitated by a consideration of fig. 4, which will also serve to give a clearer idea of the somewhat complicated phenomena which appear when α -rays fall upon a metal in a high

* Am. Journ. Sci. xxxv. p. 295 (1913).

† *L. c.* p. 303.

vacuum. The figure shows graphically the results of measurements, all of which were made on the same day, after the vacuum had been maintained for eight days. Curve I shows the currents received by the electrode, with the case grounded

Fig. 4.

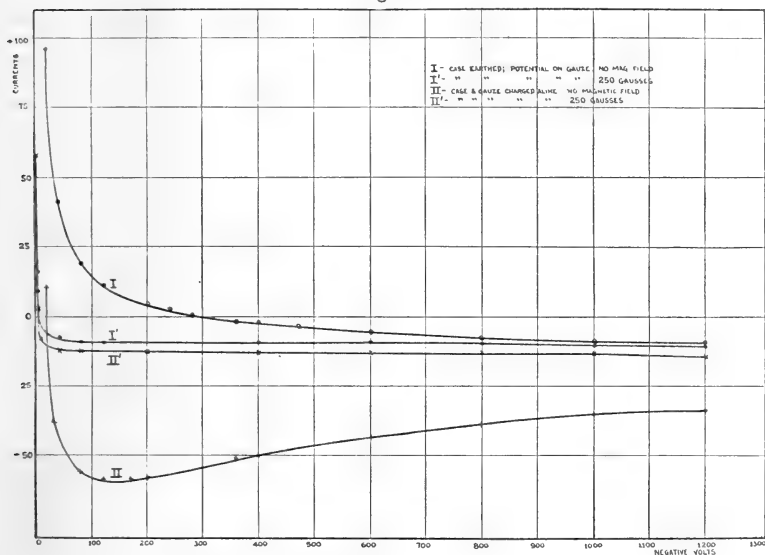

and with negative potentials between 20 and 1200 volts on the gauze cage. Curve II represents the currents when both case and gauze are charged alike. Curves I' and II' give the currents observed under similar electrical conditions as in I and II respectively, but with a magnetic field sufficient to give its maximum effect. Curve I is similar to those plotted in fig. 3 except for the change in scale due to the altered capacity, and for the fact that it begins at 20 volts instead of 40. According to the views advanced in § 4, an ordinate of this curve represents (with more or less accuracy) the number of electrons whose energies are greater than that represented by the abscissa; these ordinates, however, are to be measured, not from the axis, but from a line below it representing the constant current received by the electrode. This corrected zero line may coincide with I', or it may fall below it, since it is not certain that all the carriers of this current get through the magnetic field. Curve II represents the resultant of the current of δ -electrons from the source, and the current of tertiary electrons from the case: at 20 volts the δ -ray current predominates, but at higher potentials the tertiary electrons are in the majority.

Their number decreases, however, as higher negative potentials are applied, owing to the decreased number of δ -electrons which reach the case. Their presence can still be detected, however, at 2000 volts. The course of II shows that the gauze cage acts as an entanglement to the tertiary electrons even when there is no field between it and the case; for when the cage is absent the tertiary current reaches a maximum at 40 volts, while with the cage (as shown in II) the maximum occurs at 150 volts.

On the view advanced in the preceding section, the negative ordinates of I' and II' represent the current carried by positive ions generated by the α -rays in the gas film upon the electrode. I have been unable to find an explanation for the difference between the two curves.

Considered as representing the distribution in velocity of the swifter δ -rays, the measurements represented by Curve I (or by the curves of fig. 3) are subject to certain sources of error, of which the following appear to be most important.

1. Some of the δ -electrons, whose velocity is nearly but not quite great enough to get through the electric field, may approach near enough to the gauze to be captured by the auxiliary field between it and the case. A consideration of the electric field in the neighbourhood of the gauze shows, however, that to be so captured, an electron must approach fairly near to the gauze; thus at any given voltage, the electrons improperly captured must lie between narrow limits of velocity and would form a small fraction of the total not returned to the electrode. Moreover, since the shape of the lines of force near the gauze remains the same, this fraction would not vary very much for different potentials. The principal effect, therefore, of this error would be to increase each ordinate of the curve in nearly the same proportion, which would not seriously affect its accuracy.

2. Some of the tertiary electrons, set free by the δ -rays which strike the gauze, may be returned to the electrode. In a preceding section reasons have been given for supposing that these will form a nearly constant fraction of all the tertiary electrons from both gauze and case. If this be so, Curve I lies below its true position, each ordinate having subtracted from it a fraction of the corresponding ordinate of II. This would alter the course of I, depressing it most between 100 and 200 volts, and less at higher potentials. This correction, however, cannot be large. The wires of the gauze occupy only 17 per cent. of its total area, and certainly most of the tertiary electrons which originate upon it must

be captured by the auxiliary field. It is quite improbable that this correction can amount to more than 1 or 2 per cent. of the ordinates of Curve II.

3. Some of the δ -rays originating upon the sides of the box-source will cross its opening obliquely, and will be *deflected*, so as to strike the box, by fields too small to stop them. Thus at any given potential, some electrons which should get away will not do so, and the ordinates of Curve I will be thereby diminished. But the number thus improperly stopped at any voltage must be a nearly, or quite, constant fraction of those which should escape, so that the effect would be merely to change the scale of the curve.

We may reasonably conclude, I think, that the measurements given represent a fair first approximation to the distribution in velocity of the swifter δ -rays. It will probably be possible to improve the accuracy of the determination by using a more intense source of α -rays and receiving a restricted beam of δ -rays in a Faraday cylinder. A suitable source of α -rays for this method is not at present at my disposal.

§ 6.

The preceding measurements have had to do only with δ -rays whose velocities exceeded 20 volts. By reducing the sensitiveness of the electroscope to somewhat less than one-eighth of its former value, measurements could be taken with smaller negative potentials on the gauze cage. A series of observations made in this manner is represented in fig. 5 (p. 248). It is within this region that all previous measurements of the velocities of δ -rays have been, so far as I know, confined. Most, if not all, of such measurements have been, I believe, to a considerable extent vitiated by two circumstances: lack of knowledge of the existence of the swifter rays and of the tertiary rays which they produce; and the fact that the α -rays were allowed to pass through the field, thus giving two sources of δ -rays, and of tertiary rays, with much consequent confusion of the results.

Among neither the swifter, nor the slower, rays is there any approach to the Maxwellian exponential distribution; if it were so, the integrated curves (those of figs. 3, 4, and 5) would also be exponential. This is not true in either case*;

* In the curves of figs. 3 and 4 allowance must be made for the depression of the zero line; but no reasonable adjustment of this sort will bring the curves near to an exponential form.

the diminution in the ordinates is too rapid at the lower potentials and too slow at the higher. If we plot \sqrt{V} instead of V , thus making the abscissæ proportional to velocities instead of to kinetic energies, the result is still very far from an exponential curve.

Fig. 5.

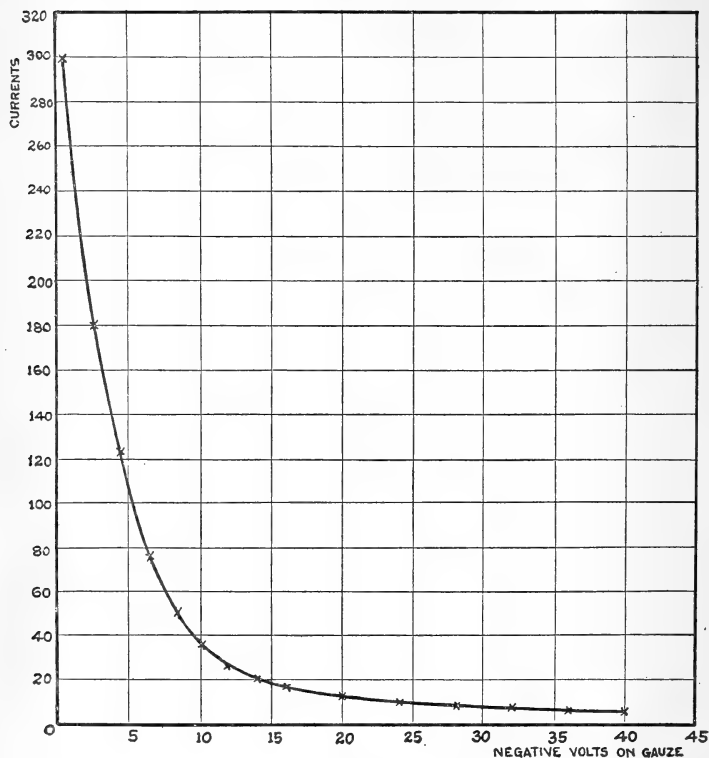

The form of the curves, however, for both the swifter and the slower electrons suggests an equation of the form $yx^n = C$. In fact, a very fair agreement between the observations from 30 to 500 volts and this equation may be obtained by using $n=0.75$, as may be seen from Table II. In this table the observed currents have been increased by 12 units to allow for the ionic current discussed above.

The departure of the observations from the equation at the higher voltages may or may not be of significance, since the currents under these conditions were small and could not be very accurately measured, and the placing of the zero

line is uncertain. At the lower potentials, however (beginning at 20 volts), the equation does not fit at all. This may well be due to the large admixture of tertiary electrons at these potentials, while above 40 volts there can be few, if any, of these. An approximate representation of the distribution of the slower electrons may be obtained with an equation of the same form, but with a larger value of n , between 1.5 and 2.

TABLE II.

$yx^n = C.$

$n = 0.75.$

x (volts).	y (obs. +12).	y (calc.).	Diff.
20	108	89	19
40	53	53	0
80	31	31.2	-0.2
120	23.5	23.2	+0.3
160	19	18.7	+0.3
200	16.7	15.8	+0.9
240	14.6	13.8	+0.8
280	11.8	12.3	-0.5
320	11.4	11.1	+0.3
360	10.5	10.2	+0.3
400	9.5	9.4	+0.1
480	8.5	8.2	+0.3
600	6.2	6.9	-0.7
800	4	5.6	-1.6
1000	2.6	4.7	-2.1
1200	1.3	4.1	-2.8

In order to get an idea of the relative magnitudes of the currents observed under various conditions, a rough series of comparisons was made by altering the sensitiveness of the electroscope, and introducing a small mica condenser. The results were as follows:—

Electronic current at -40 volts . . .	43
" " " -20 " . . .	100
" " " - 2 " . . .	1700
" " " 0 " . . .	2700
" " " +40 " . . .	5800
Current carried by α -rays	200
Minimum ionic current	10

It will be seen that the swifter electrons with which we have been principally concerned form only a small part of the total number which leave a metal when it is struck by α -rays. But the fact that α -rays can cause electrons to be

projected with such speeds is undoubtedly a fact of considerable importance, whether these electrons be few or many; it must have some bearing upon the theory of ionization by α -particles and of their passage through matter. It is not altogether surprising that α -particles should cause electrons to be projected with velocities corresponding to some hundreds of volts. According to the theory of Einstein, the energy of electrons projected under the influence of ultra-violet light is a linear function of the frequency of the light. This theory has been extended with some degree of success to the electronic emission caused by Röntgen rays, taking, instead of the frequency, the time occupied by the pulse in passing over an electron, and estimating this as well as can be done in the present state of knowledge. If we assume that the effective field about an α -particle has the diameter of an atom, 10^{-8} cm., then, since its velocity is about $2 \times 10^9 \frac{\text{cm.}}{\text{sec.}}$, its time of passage over an electron will be $\frac{1}{2} \times 10^{-17}$ second. The frequency of ultra-violet light is about $\frac{2}{3} \times 10^{15}$ second, so that we might expect the maximum energy of the δ -rays to be of the order of 100 times that of photoelectric electrons.

It has been shown that the number of slow δ -electrons varies with the speed of the α -rays in much the same manner as the number of ions produced in a gas. I have not yet been able to determine whether this is so with the swifter δ -rays, nor how their distribution in velocity varies (if at all) with the speed of the α -rays. Knowledge of this sort might throw considerable light upon the relations between the electrons of various speeds, and upon the mechanism of ionization by α -rays, about which very little is known at present.

Summary.

1. When α -rays fall upon a metal, electrons are emitted with velocities varying continuously from a very small value to more than $2.7 \times 10^9 \frac{\text{cm.}}{\text{sec.}}$, which corresponds to a potential difference of 2000 volts. It is proposed to include under the name " δ -rays" all the electrons which owe their origin to the direct action of the α -rays,—the swifter ones as well as the slower ones previously known,

2. Evidence is given for the view that, in addition to the δ -rays, positive ions are also produced when α -rays impinge

upon a metal in a very high vacuum; these ions appear to come from the layer of adsorbed gas upon the metal. By maintaining the vacuum for several days, the current carried by these ions may be reduced to a small value,—from 5 to 10 per cent. of that carried by the α -rays themselves. The present experiments do not determine whether or not these ions leave the plate with an appreciable velocity in the absence of an electric field; but there is some evidence that the velocity is, at all events, small.

3. When the swifter δ -rays fall upon a solid it emits electrons of slow speed which, in the present paper, are referred to as tertiary electrons. Their number is considerably greater than the δ -rays which produce them. The existence of the tertiary electrons makes it difficult to determine with accuracy the distribution in velocity of the δ -rays. A large number of tertiary electrons come from the source of δ -rays itself, and their presence in the beam of δ -rays makes it impossible to draw valid conclusions as to the number of true δ -electrons of slow speed (less than 10 or 20 volts).

4. The distribution in velocity of the δ -rays between 20 and 1200 volts has been determined, and reasons are given for believing that the measurements represent a fair approximation to the true distribution. The number of electrons having a given kinetic energy is not an exponential function of either the energy or the velocity. Between 30 and 500 volts, the results are approximately represented by an equation of the form $\gamma x^n = c$, where γ is the number of electrons whose kinetic energy is equal to or greater than x , and $n = 0.75$. It is impossible to say whether or not the departure of the measurements from this equation at potentials higher than 500 volts is significant; the quantities measured are small and their values are rendered somewhat uncertain by the presence of the positive ions and of the tertiary electrons. On the other hand, the fact that the slower electrons (under 20 volts) do not follow the same law of distribution in velocity as the swifter ones is to be expected; the presence of tertiary electrons from the source, in the beam of δ -rays, should greatly increase the numbers of the very slow electrons, as is, in fact, found to be the case.

Sloane Laboratory, Yale University,
Apr. 15, 1913.

XVII. *On the Action of a Magnetic Field upon the Electric Discharge through Gases.* By LOUIS T. MORE, *Professor of Physics*, and S. J. MAUCHLY, *Hanna Fellow in Physics, The University of Cincinnati* *.

THE action of a magnetic field on the electric discharge through gases has been studied almost continuously since the first experiments made by Plücker in 1858. An excellent résumé of the whole subject is given in Sir J. J. Thomson's 'Conduction of Electricity through Gases.' The theory often advanced is that the magnetic field causes the charged particles of the current, and especially the negatively charged electrons, to move in helical paths along the lines of magnetic force. This action must certainly occur, and it explains what may be called the primary effect of the magnetic field. But there are other numerous and very complicated phenomena, evidently of a secondary nature, which the field produces and which apparently have not been included in the theory. Professor Righi has made an elaborate study of these actions of the magnetic field, during which he has greatly extended our knowledge of the subject by ingenious experiments. He has also advanced a new theory to account for both the primary and secondary actions of the field. According to this theory, the magnetic field causes positive ions and negative electrons to unite as rather loosely bound rotating doublets, which are then driven along the lines of magnetic force. The secondary effects, he explains by dissociation of the doublets as they move out of the field.

In most of his experiments, Professor Righi disposes the magnetic and electric fields so as to coincide in direction. If we neglect some of the minor details of his work, we can summarize the main facts brought out by his researches (when the axis of the magnetic field coincides with the axis of the vacuum tube) as follows:—

In the region of the negative glow, the magnetic field produces many ion-electron doublets which are driven away from the cathode. These "magnetic rays" appear in the form of a cone of blue light whose axis coincides with the axis of the tube and whose apex is farthest from the cathode. He finds these rays to be electrically neutral, since when collected in a Faraday pail they give to it no charge. Also, if an auxiliary or test-magnet be held near the tube, the rays bend directly toward or away from its pole, according to its

* Communicated by the Authors.

polarity. We may call these magnetic rays the primary effect of the magnetic field.

Professor Righi tried many different forms of tubes, and finally adopted one in which the anode was placed in a side branch, and the part into which the magnetic rays extended was enlarged into a cylinder about a metre long and seven or eight centimetres in diameter. He then found when the field was excited, that this large tube became filled with an electric glow discharge, to which we have given the name of "the induced column," for it evidently is dependent on the primary magnetic rays and is thus secondary in nature.

Professor Righi describes this induced column as a column of light beginning near the base of the conical magnetic rays and filling practically the whole tube. Somewhere near the middle of the column is a region of comparative darkness which contains an excess of positive ions; and at the far end of the tube there is a similar place showing an excess of negative electricity. This virtual anode causes a current of positive electricity to flow from the middle of the column to the two ends of the tube. This is shown by the fact that if the pole of a test-magnet is moved along the column, the light is deflected in a circular arc about the pole and the convexities of the curves of the two portions of the column are in opposite directions, indicating currents flowing in contrary directions. The colour of the light in the two portions of the column is different; it is blue in the half nearer the cathode and pinkish in the farther half.

The induced column is sometimes striated and it is always periodic. This periodicity is shown in several ways. A clear musical note of high pitch is emitted; the light viewed in a rotating mirror is banded; and a telephone introduced in the circuit buzzes.

The virtual anode, Professor Righi assumes to be the location of the limit of the paths of the positive ions set free by the dissociation of the ion-electron doublets, and the virtual cathode at the far end of the tube is the similar limit of the paths of the freed electrons.

Work was begun in this laboratory somewhat over two years ago with the intention of confirming and extending these discoveries and the theory of Professor Righi. In an article* published in this magazine, his results were confirmed, but characteristic variations were found when the tube was filled with gases other than air, which had been the only one hitherto used.

The authors found that the magnetic rays themselves were

* More & Rieman, *Phil. Mag.* vol. xxiv. p. 307 (1912).

but little affected by the nature of the gas. The only variations noted were small differences in their length and concentration along the axis; the maximum lengths are attained at pressures and field strengths which were different with different gases. The important variations were observed in the induced column; with pure gases, oxygen, hydrogen, nitrogen, and carbon dioxide, no virtual anode could be located, and the entire column bent around the pole of the test-magnet in the same direction. The column was also short and diffuse. The virtual anode and the double curving of the column was found only with air, and to a less degree with artificial mixtures containing nitrogen. These results were difficult to explain by Professor Righi's hypothesis.

Another point was commented upon. In all cases, the magnetic rays are concentrated along the axis of the tube as a well-defined cone, with its base near the cathode. This seems to be quite at variance with the hypothesis. If the rays are composed of electrically neutral doublets, then the only motive force acting on them is the magnetic field, and the rays should follow the magnetic lines of force. These lines of force which emanate from the pole of the electro-magnet certainly diverge, so it is difficult to find the force which makes the rays converge.

Shortly after its appearance, Professor Righi * published a criticism of the paper. His opinion is that the results which were observed can be explained by his new theory, if it be properly modified, and that they cannot be understood in the light of the usual explanation, according to which the action of the field is limited to altering the path followed by the electrons. He limits his criticism to the newly-discovered variations in the induced column and makes no reference to the convergent form of the magnetic rays, although that seems to be the more difficult to explain. He thinks the discovery that a virtual anode does not exist in some gases is not prejudicial to his theory. His comment is: "Instead, in this case it happens plainly, that the virtual anode is formed at the extremity of the magnetic rays, as I showed to happen, and as must happen, also with air, when the intensity of the magnetic field is relatively feeble." Now we do not believe that this explanation is correct. Since it was assumed that the position of the virtual anode is the locus of the limit of the free path of the ions formed from the dissociated doublets, we can say confidently that the virtual anode must lie at least some distance beyond the extremity of the magnetic rays, and that this distance will be increased by

* Righi, *Phil. Mag.* vol. xxxiv. p. 804 (1912).

increasing the magnetic field and by diminishing the pressure of the gas. Our apparatus was such that the field and pressure could be varied from inferior limits not sufficient to produce the rays, to superior limits which destroyed the rays in any gas used. By varying these two factors, the virtual anode, when it could be found at all, could be made to shift its position to practically any part of the column. If the virtual anode, accepting Professor Righi's definition of it, existed near the extremity of the magnetic rays in the various gases, why could it not also be shifted, by varying the field, to a position where it could be observed? This objection to his hypothesis still seems to stand.

But Professor Righi, whether the objection is valid or not, relegates it to a minor position when he writes: "There is a research which ought to have been initiated before formulating doubts or objections; that of examining if the marked intermittency produced in the discharge by the magnetic field when the tube contains air (which intermittency is strictly connected with the formation of the virtual anode), is produced or not with those gases in which the induced column was not observed by the authors. Evidently if, for any reason whatever, known or unknown, the periodicity did not exist, the want of the induced column would be the natural consequence." It must be confessed that the writers failed to understand that the intermittency was so connected with the formation of the virtual anode, or was so vital to the theory of magnetically formed doublets and rays. We have, naturally, investigated this subject carefully, and shall show in this paper that, as the intermittency is not dependent on a magnetic field, it cannot be thus vitally connected with the formation of a virtual anode, or with Professor Righi's theory.

Our excuse for giving this rather long statement and discussion of the problem is, that the results about to be described have forced us to abandon Professor Righi's theory. Our new modification of his apparatus has enabled us to obtain results so decisive, that we believe we can now offer a fairly accurate and simple explanation of both the primary and secondary effects which occur when an electric discharge is influenced by a magnetic field.

The principal thing which has hampered the work in the past was the use of an induction-coil or an electrostatic machine as a source of potential. The potential is then not sufficiently uniform, and the rays are rather unstable. The potential is too high, it cannot be measured accurately, and it produces too little current. All these defects are avoided by

using a Wehnelt cathode in the tube, as we can then get a large current with a low and steady potential from storage-cells.

The modified discharge-tube is shown in fig. 1. The

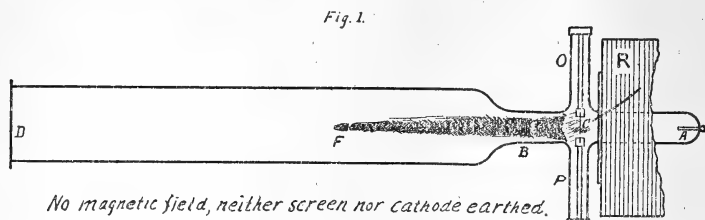

main part of the tube, BD, is, as before, a metre long and 7 centimetres in diameter; the extension, BA, is 2.5 cm. in diameter; and the cathode, C, is 15 cm. from A and 8 cm. from B. To avoid any constriction in the tube, the two parts are so joined at B with a sealing-wax joint that BD slips over BA. The entire main portion is covered with a close-fitting screen of copper gauze, which may be either insulated or connected to earth.

The anode, A, is a straight aluminium rod and the cathode, C, is of the Wehnelt hot lime type. The cathode is shown in detail in fig. 2. Two open glass tubes, O and P, are sealed

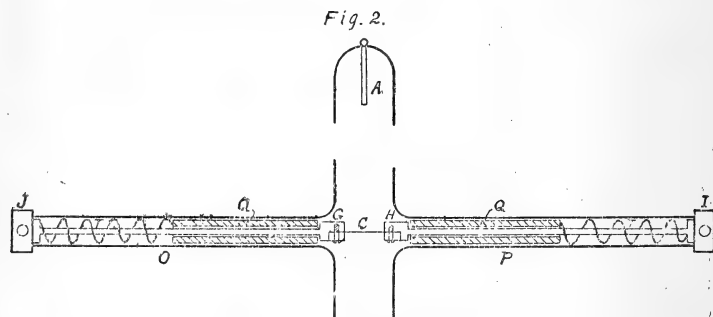

to the extension tube. Stout brass rods with brass heads, J, G, H, and I, are inserted in these tubes, and are kept accurately coaxial by the short lengths of barometer tubing, Q, and the spiral brass springs, T. The heads, J and I, serve as terminals for the heating current and for the cathode end of the discharge-current, and, when sealed with wax, close the ends of the tubes. The other heads, G and

H, contain each a vertical slot. Their front faces are movable, and act as clamps to hold a platinum strip, C. Since this platinum strip frequently burns out and the deposit on it wears off, it is necessary to have a convenient method of renewing the cathode. For this purpose the tube, BD, is removed and a platinum strip, which is held in a long metal finger, is dropped into the slots. The movable faces of the heads, G and H, are then brought fast against the strip by small set screws.

The cathode strips are made of new platinum, and are 18 mm. long, 1.5 mm. wide, and 0.025 mm. thick. Before such a strip is put in place it is chemically cleaned and handled only with the metal finger; after insertion in the slot, it is kept at a bright red heat a long time by means of a current of electricity, and then touched, while still a little warm, with a small crystal of calcium nitrate or with the point of a fine thread of sealing-wax. The current is afterwards increased until oxidation has taken place. The deposit has, of course, been placed on the centre of the face of the strip away from the anode. The cathode is now ready for use, and the tube is re-sealed.

The discharge-current was supplied from a high-tension battery of a thousand storage-cells. Most of the results were accomplished with a potential of a thousand volts or less. The field-magnet was the one described in the previous paper, and while a field of about 2000 units could be obtained at a distance of a centimetre and a half from its pole, considerably less intense fields were commonly used. The usual connexions, with dryers of phosphorus pentoxide, were made to a Gaede pump, a McLeod gauge, and a device with a mercury column seal for admitting dry and purified air.

The pressure at which the magnetic rays occur is somewhat lower in the present arrangement with the Wehnelt cathode than in previous experiments. The best conditions seem to lie between 0.06 and 0.09 mm. with a potential of 1000 volts. While the rays are readily started and maintained, yet there is a tendency for the current to pile up and become so intense as to burn out the platinum strip if the full current is started suddenly. It is therefore best to heat the cathode strip at first to a point considerably below the working temperature. If the cathode is then gradually heated, a discharge first starts between the anode and the cathode; additional heating brings the temperature to a point where a luminous glow suddenly appears and extends from the deposit into the main tube. But frequently, instead

of remaining constant, this glow rapidly increases with flashes of white heat from the deposit; if this occurs the strip soon burns out. For this reason both the high tension and the heating circuits must be arranged so that they can be instantly broken.

When the glow discharge is seen to be regular the magnetic field should be applied. It is a curious fact that a fresh strip and a fresh charge of gas behave quite differently from those which have been used for some time. At times it takes days, and always hours, of constant manipulation before a good and constant discharge can be obtained in fresh gas; but after the gas has been once broken in, the rays can be started at any time. And it is with fresh gas that flashing is so apt to occur. This is somewhat similar to the results found by Paalzow and Neesen*, that a magnetic field sometimes helped and sometimes hindered the discharge, and to the observation of Skinner†, who notes the difficulty at times of getting a discharge through a gas.

The phenomena connected with magnetic rays can be best shown by describing the appearance of certain typical forms.

In fig. 1 is shown the appearance of the discharge when there is no magnetic field acting, and when neither the gauze sheath covering the tube nor the cathode is earthed. The branch tubes are omitted in these diagrams, except fig. 1, and the cathode is indicated at C. The luminous column is about 40 cm. long; it sometimes ends in a more or less sharp point and sometimes with a detached knob, as shown in the figure. Extending beneath the cathode is a curved tongue of pinkish-white glow. There are the usual phenomena of the Crookes's tube present to the right of the cathode, which need not be shown; while to the left is a dark space similar to the Crookes's dark space; and beyond it for several centimetres there is a bluish glow, which gradually changes into the more pinkish column, BF.

Fig 3

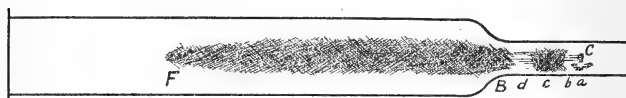

No magnetic field screen earthed, cathode not earthed.

If we now leave the conditions as before, except to earth the screen (fig. 3), the luminous glow, BF, nearly doubles in length and gives out a high musical note. The glow

* *Wied. Ann.* vol. lxiii. p. 209 (1897).

† *Phil. Mag.* vol. 1. p. 563 (1900).

under the cathode, *a*, is unchanged, but the dark space, *b*, becomes more sharply defined, and a second dark space makes its appearance at *d*. Between these a bluish-violet glow, *e*, is present.

The appearance of the discharge is notably altered if the cathode is also earthed (fig. 4). The luminous column, BF, expands and fills practically the entire tube. In addition to the previous distribution of glow and dark spaces in the portion BC, a sharply defined and bright pinkish-white band of light appears at *e*, just at the beginning of the blue luminous column. This band, *e*, has the appearance and characteristics of the positive column in a Crookes's tube, and is affected by a test-magnet in a similar way to the

Fig. 4.

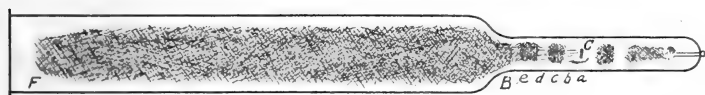

No magnetic field, screen and cathode earthed.

positive column on the right of the cathode. In fact, we have a symmetrical and identical distribution on the two sides of the cathode—the Crookes's dark space, the negative glow, the Faraday dark space, and the positive column. A test-magnet bends the luminous column to indicate a positive current flowing from B to F. The pitch of the note is lower than in the previous case.

We next start a current in the field-magnet, and increase it until the typical magnetic ray discharge is obtained. This is shown in fig. 5. As the field becomes gradually intense,

Fig. 5.

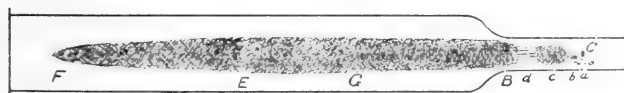

Magnetic field, screen and cathode earthed.

the bluish glow, *e*, retreats from the cathode, and the bright pinkish band, *e*, which we have called the positive column, creeps down the tube into the wide portion. When a critical point in the field strength is reached, it suddenly expands into a long column, BE, while the column which formerly occupied the whole tube is compressed into the portion EF. At the same time the conical core of blue magnetic rays,

BG, appears. While this core is shown detached from the cathode, it is really attached to the cathode by fine pencils of cathode rays proceeding from the deposit on the cathode, which often show a helical path under the action of the field. The core of magnetic rays, BG, bends toward or away from a test-magnet, and the column, BEF, has the characteristic action of an induced column when acted on by the test-magnet; that is, the reversed curvature on the two sides of the place, E, which Professor Righi has called the virtual anode. No one can see the phenomena above described without being convinced that the action of the magnetic field is simply to push the luminous discharge away from the cathode. In further confirmation of this fact, we are now able, by adjusting the pressure, the potential, and the temperature of the cathode, to obtain an identical distribution of the glow in the tube, the virtual anode, and the reversed bending of the induced column when there is no magnetic field acting. That is, the appearance of the discharge *without* a magnetic field (fig. 4) may be made the same as the appearance *with* a magnetic field (fig. 5). There is, of course, the one difference, that the cone of magnetic rays is replaced by a cylindrical beam of cathode rays.

A very curious and significant action sometimes takes place in the pinkish band *e*, which we shall, in future, call the positive column. If the field is made rather too intense, slight variations in the other factors cause this positive column, *e*, to move towards the cathode, instead of away from it as in the last case. When this happens, the band *e* continues to approach the cathode until it unites with the negative glow *c*, or else disappears. Although the magnetic rays persist, the induced column now shows no double and reversed curvature with a test-magnet.

Before considering any further experiments, we should first discuss the effect of substituting a Wehnelt cathode for the high potential cold cathode which is used by other investigators. It is quite evident that the Wehnelt cathode produces effects which in themselves approximate to the action of the magnetic field. We have an abundance of slow moving cathode rays which emanate from the deposit and stream away from the cathode, the potential drop at the cathode is lowered and the current is large.

The effect of the magnetic field in lowering the potential drop at the cathode is well known. This fact was discovered by Paalzow and Neesen*. Later, Almy† found that a

* Paalzow and Neesen, *l. c.*

† Almy, Proc. Camb. Phil. Soc. vol. xi. p. 183 (1901).

coaxial magnetic field produces an enormous drop in the potential difference ; and also that the magnetic field causes the discharge to concentrate in one or more bright streams instead of discharging from the whole cathode. This concentration is, of course, a feature of the discharge from a hot lime cathode. Gouy and Bloch* have both noted this effect of a magnetic field on the potential. The former has advanced a rather complicated theory to explain this action, but it seems more reasonable to accept the opinion of Bloch, who bases it on the principle of disruptive discharge in a magnetic field. This lowering of the potential and consequent increase of the current is also obtained by earthing the cathode and the gauze screen, as is shown by the marked increase in the length of the discharge in the tube (see figs. 3 and 4) ; after discovering this effect of connecting the cathode to the screen and to earth, we found that Almy † had already discovered that this effect can be obtained without the magnetic field if the cathode is connected to a tinfoil covering placed on the tube near the cathode.

If the action of the magnetic field is to cause a stream of electrons to move in a helical path rather than to create neutral doublets, it is important to make this path evident. Gouy ‡ has recently shown the spiral form of these rays by an ingenious experiment. He allows a pencil of the magnetic rays to fall on an inclined crystal and observes the trajectory of the path of the reflected light. We have found it easy to show that the path is a helix. To accomplish this, an extremely small spot of sealing-wax was deposited on the cathode. The cathode ray emitted from this spot was a fine line of brilliant blue light. Under the action of an intense magnetic field, this ray was twisted into a sharply defined helix of small pitch.

A study of the appearance of the discharge, as shown in figs. 4 and 5, when the screen and cathode are earthed and with or without a magnetic field, is convincing as to the identical arrangement of glow and dark spaces on the two sides of the cathode. We have first, on the left side, the glow on the cathode accompanied by long streams of cathode rays from the hot lime deposit. Then, in order, are a dark space similar to the Crookes's dark space ; a bluish luminous glow similar to the negative glow ; next, a second dark space corresponding to the Faraday dark space ; and finally,

* See articles by Gouy and by Bloch, *C. R.* 1910 and 1911, *passim*.

† Almy, *l. c.*

‡ Gouy, *C. R.* vol. clii. p. 353 ; *Le Radium*, vol. viii. p. 129 (1911).

a pinkish-white positive column which behaves in all respects like a positive column in a Crookes's tube. These phenomena led us to believe that there was a true current through the glass of the tube. To test this, a sensitive galvanometer was connected with one terminal to earth and the other to the insulated gauze screen. A permanent deflexion was obtained, indicating a direct current from the earth to the screen; reversing the connexions of the galvanometer, the deflexion also reversed. A telephone, placed in this circuit, gave a distinct sound; the current, while direct, must therefore be intermittent. As a current persists when the cathode and screen are both earthed, there must be a virtual cathode on or near the inner surface of the glass tube, and a virtual anode at a point in the induced column.

Professor Righi places emphasis on the existence of this virtual anode as a support to his neutral doublet theory. But the fact is, a virtual anode must be present if the gauze screen is earthed, whether there is a magnetic field or not, as is shown by the presence of this current through the glass of the tube. So far as the division of the induced column into two portions, with a virtual anode somewhere near its middle, is concerned, that effect may be obtained without a magnetic field if we use a Wehnelt cathode and make a proper adjustment of pressure, potential, and temperature of the cathode strip; the controlling factor in obtaining this effect is thus to force the positive column, e , out into the large tube. Undoubtedly, Professor Righi was compelled to use a magnetic field for this purpose, and even to obtain any induced column at all, because with the ordinary cathode, the potential drop is so great at the cathode that there is no force to repel or drive the discharge from the cathode. On the other hand, the hot lime reduces the potential drop and sends out a stream of cathode rays from the cathode just as the magnetic field does. In fact, the induced column in the large tube is somewhat unstable and occasionally breaks up into striæ; it is possible that this reversed bending by a test-magnet is but another phase of the helical twist which may be given to the heads of these striæ. In one or two instances we obtained columns which showed two virtual anodes. At least, it is not necessary to assume that a virtual anode is the limit of the paths of positive ions derived from neutral doublets which were originally created by a magnetic field.

The importance of determining the conditions which make the discharge intermittent is readily understood when it is recalled that Professor Righi states that a virtual anode should not be expected unless the discharge is periodic.

And still more important is his statement that a magnetic field is necessary for a periodic discharge and that his theory alone will account for this periodicity. There is no doubt that the discharge is periodic when it is acted upon by a magnetic field, because a high musical note is heard and a telephone placed in the circuit buzzes, but the action requires a more careful inquiry.

For this purpose a four sided rotating mirror was set up with its axis vertical ; that is, perpendicular to the axis of the tube. It was driven by an electric motor, controlled to give any speed up to 1800 revolutions per minute. To examine the appearance of the discharge in different parts of the tube, a screen with an opening about two centimetres square was placed so as to intercept all the light except that from the desired place. When the discharge was a continuous one, the light reflected from the mirror was broadened into a uniform band. On the other hand, an intermittent discharge caused the band of light to be crossed by vertical dark bands. These dark bands moved either to the left or to the right according as the speed of the mirror was too slow or too fast. In all cases the mirror could be driven fast enough to reverse the motion of the bands. For short intervals, the motor was regulated to keep the bands stationary in order to obtain an approximate determination of the periodicity.

The results of the periodicity are given in the table :—

Screen insulated ; cathode insulated ; no magnetic field : discharge is continuous.

Screen earthed ; cathode insulated ; no magnetic field : discharge is periodic.

Screen earthed ; cathode earthed ; no magnetic field : discharge is periodic.

Screen earthed ; cathode earthed ; magnetic field acting : discharge is periodic.

If we call the period normal when the screen alone is earthed and the magnetic field is not acting, then, if we also earth the cathode, the period is very noticeably lengthened. If, instead of earthing the cathode, the magnetic field is applied, the period becomes shorter than the normal ; but the change is not so great as when the cathode was earthed. At times, when the cathode was earthed and the magnetic field also acting, two notes could be distinguished ; the low note due to the former and the high one produced by the magnetic field. In the mirror, the light was broken up into

bright and dark bands, and the bright bands were crossed by fine bright and dark spaces.

Investigators in this subject soon become acquainted with the instability of the discharge when affected by the magnetic field. Frequently the glow flashes and then stops. This succession of appearance and disappearance was very erratic with a high potential cold cathode. But this intermittent ray may be made quite regular with the Wehnelt cathode. To produce this regular intermittency, the cathode platinum strip is heated sufficiently to give off electrons, but not hot enough to produce a continuous discharge. By regulating the pressure of the gas, the potential, and the strength of the magnetic field, the period between successive flashes could be changed from several minutes to a fraction of a second. In fact, the succession of flashes may be made too rapid to count. This intermittency was exceedingly sensitive to the temperature of the cathode; small variations in the heating current being sufficient to alter its character and period markedly.

The explanation of this intermittent action is simple. With a Wehnelt cathode we have an abundant and steady supply of electrons near the cathode and a great lowering of the potential fall necessary to produce a current. But if we cool the platinum strip to a dull red, and at the same time reduce the power of the other factors which tend to produce the luminous discharge, we still have many electrons produced at the cathode, but not sufficient to maintain a steady current. The electrons accumulate until a critical value is reached, the flash of light occurs in the tube and then goes out because of the insufficient rate of supply of electrons. The phenomenon is accordingly repeated only intermittently. This explanation is clearly supported by the way the negative glow on the anode side of the cathode creeps toward the cathode until, when this is almost reached the luminous discharge takes place; the cessation of the discharge is accompanied by the jumping of the negative glow away from the cathode.

The high frequency of the induced column which Professor Righi takes to be the criterion of magnetic rays is in all probability to be explained in a similar way. It is almost possible to make the intermittent discharge pass into a high frequency induced column. An intermediate step exists, when the column is not slowly intermittent, and, on the other hand, does not give the tone denoting high frequency, but is striated*. Whether this explanation is

* Note: During long period flashes, rapid periodicity was often noted.

correct or not, it is at least certain that a magnetic field is not at all necessary to make the discharge periodic.

In order to determine whether the high frequency period is accompanied by striation of the luminous column, the following test was made. The rotating mirror was placed with its axis parallel to the tube; that is, parallel to the axis of the column. If the screen was not earthed, the mirror showed a continuous band of light; but when the screen was earthed, this image was at once replaced by bright bands separated by dark spaces. These bands were parallel to each other and to the column of light. Various modifications of the period showed only a variation in the width of the dark spaces, and never any striation normal to the axis of the column. It follows, therefore, that this periodicity is due to alternate formation and extinction of the entire luminous column, and is not the result of striation.

Professor Righi's conclusion, that a magnetic field was necessary to make the discharge periodic, was natural, as he used a high potential cathode; with this arrangement, no electrons are given off until the potential is sufficient to produce ionization of the gas, and when this occurs the current is continuous. It is, however, maintained by some that, even in the ordinary Crookes's tube, the current is periodic as shown by its striated appearance; the evidence is rather against this opinion. But when a magnetic field is applied which lowers the potential fall at the cathode and impels electrons away from the cathode, it is reasonable to expect that so many electrons may be driven away as to stop the current until they again accumulate. At any rate, it is evident from our experiments that the discharge from a Wehnelt cathode is periodic if the tube be covered with a metal screen connected to earth, whether there is a magnetic field acting or not.

The evidence is conflicting as to whether the magnetic rays (that is, the portion of the discharge which bends toward or away from the pole of an auxiliary magnet) are streams of electrically neutral or negatively charged particles. Righi deflected the magnetic rays into a branch tube, and states that no charge was given by them to a Faraday pail. But Thirkill* was able to coil them into a very fine spiral along the lines of magnetic force passing through the cathode. He also collected them in a Faraday pail and found they carried a negative charge. Both of Thirkill's results have been

* Thirkill, *Proc. Roy. Soc.* vol. lxxxiii. p. 324 (1910).

confirmed by Gouy*. While these results point very strongly against Righi's theory, they are not conclusive. His theory of neutral doublets does not exclude the possibility that the magnetic rays may contain a large number of free electrons.

But if, in addition to the negative charge and spiral path of the magnetic rays, the form of these rays is considered, the evidence is entirely in favour of the theory that the function of the magnetic field is to twist free electrons in a spiral path and drive them from the cathode. If they were neutral doublets, the only driving force would be the magnetic field, and they must follow the magnetic lines of force. Instead of following the lines of force which diverge from the pole of the magnet, the magnetic rays converge to a cone whose apex lies on the axis of the tube. On the other hand, if the rays are negatively charged particles, they are driven by two forces, the magnetic and electric fields.

Sir J. J. Thomson † has discussed this question, and finds that the electrons are driven along the lines of magnetic force in helical paths of gradually increasing pitch. But they also have a drift in the direction of the lines of electric force. In the present arrangement, this drift out of the magnetic field and into the direction of the electric field, which is parallel to the axis of the tube and most intense at its axis, would be greatly accentuated because the intensity of the magnetic field decreases far more rapidly than the electric field. This combined action would cause the electrons to move nearly parallel to the axis of the tube. The speed of the electrons is greatest along and near the axis of the tube; consequently, the nearer the path of an electron is to the axis of the tube, the farther it will move away from the cathode before losing the ability to ionize the gas and make it luminous. This would account for the actual appearance of the *conical* magnetic rays.

Former experiments in this laboratory ‡ showed that the cone of magnetic rays was but little affected by the kind of gas in the tube, and that the secondary phenomena were greatly changed. This is to be expected if the magnetic rays are composed of negative electrons, but not if they are a stream of neutral doublets, one of whose constituents is a positive ion which varies with the gas.

* Gouy, *Le Radium*, vol. viii. p. 129 (1911); *C. R.* vol. clii. p. 353 (1911).

† 'Conduction of Electricity through Gases,' 2nd edition, pp. 106 & 600.

‡ More and Rieman, *l. c.*

The results which have been brought out in this paper show conclusively, we think, that the function of the magnetic field is to modify the discharge rather than to create a new type of rays such as has been proposed by Villard and Righi. The main action of the magnetic field is to reduce greatly the potential drop at the cathode and to force charged particles in the tube to move away from the cathode in helical paths. Owing to their greater mobility and longer free path, this action is more pronounced on electrons than on positive gaseous ions.

For convenience, we may recapitulate the principal results which support this view.

The primary effect of the magnetic field is to produce a cone of bluish rays which bends toward or away from the pole of an auxiliary magnet. This cone is a stream of charged particles which leaves the cathode because the magnetic field lowers the potential fall at the cathode and exerts a mechanical force on the particles. The rays have been found to be negatively charged and to move in helical paths. A similar effect is obtained when a Wehnelt cathode is used without a magnetic field, except that the path is not helical and the bundle of rays is cylindrical and not conical, both of which differences were to be expected.

When we consider the secondary effects, we have found that every action which occurs when a magnetic field acts on the discharge from a high potential cold cathode can be obtained with a hot Wehnelt cathode when there is no magnetic field. These actions include the appearance of the discharge, the periodicity, the induced column with a virtual anode and reversed bending. In addition, we found a true, direct but fluctuating current between the interior of the tube and an earthed screen exterior to the tube. The inference is, that with a hot Wehnelt cathode the action of a magnetic field is not to change the nature of the discharge, but to displace it from the cathode and to magnify it so that the various parts seem to be changed.

It gives us great pleasure to express our thanks to Mr. P. B. Evens, whose skill in devising and constructing complicated apparatus and whose patience in overcoming difficulties and in making observations have done much to make our work successful.

University of Cincinnati,
February, 1913.

XVIII. *The Oscillations about a Position of Equilibrium where a Simple Linear Relation exists between the Frequencies of the Principal Vibrations.* By H. J. E. BETH*.

[Plates VII. & VIII.]

§1. **F**OR a mechanism with m degrees of freedom performing small oscillations about a position of stable equilibrium the equations of motion may be written in the form :

$$\left. \begin{aligned} \ddot{x} + n_x^2 x + \sum_g \dot{x}^2 + \sum_g \dot{x}\dot{y} + \sum_g x\dot{x} + \sum_g x\dot{y} + \sum_g x^2 + \sum_g xy + \sum_g x\dot{x}^2 + \dots &= 0 \\ \ddot{y} + n_y^2 y + \sum_g \dot{x}^2 + \dots &= 0 \\ \dots & \end{aligned} \right\} (1)$$

where x, y , etc. are the principal coordinates of the mechanism ; they vanish in the position of equilibrium ; $\sum_g \dot{x}^2$ is written instead of $a\dot{x}^2 + b\dot{y}^2 + c\dot{z}^2 + \dots$ etc.; n_x, n_y , etc. are the frequencies of the principal vibrations.

In his treatise † : “ On certain vibrations of higher order of abnormal intensity (vibrations of relation) for mechanisms with more degrees of freedom ” (*Verhandelingen der Koninklyke Akademie van Wetenschappen*, vol. v. No. 8, 1897 ; *Archives Néerlandaises*, vol. i. series 2, pp. 229–260), Prof. Korteweg has shown that the coordinates $x, y \dots$ may be expressed by the following expansions in series :

$$\left. \begin{aligned} x &= \alpha_{00\dots 0}^{(2)} + A h \cos \phi + \alpha_{010\dots 0}^{(3)} \cos \psi + \alpha_{001\dots 0}^{(3)} \cos \chi + \dots \\ &\quad + \sum_{pqr\dots}^{(S)} \alpha \cos (p\phi + q\psi + r\chi + \dots) \\ y &= \beta_{00\dots 0}^{(2)} + \beta_{100\dots 0}^{(3)} \cos \phi + B h \cos \psi + \beta_{001\dots 0}^{(3)} \cos \chi + \dots \\ &\quad + \sum_{pqr\dots}^{(S)} \beta \cos (p\phi + q\psi + r\chi + \dots) \\ \dots & \end{aligned} \right\} (2)$$

* Communicated by the Author.

† “ Over zekere trillingen van hooger orde van abnormale intensiteit (relatietrillingen) bij mechanismen met meerdere graden van vrijheid.”

where

$$\phi = (n_x + \sigma)t + \lambda; \psi = (n_y + \tau)t + \mu; \dots$$

$\alpha, \sigma, \tau, \dots$ are functions of h of this form :

$$\begin{aligned} \alpha &= a h + a h^2 + \dots \\ \sigma &= s h^2 + \dots \\ \tau &= t h^2 + \dots \end{aligned}$$

$Ah, Bh, \dots, \lambda, \mu, \nu, \dots$ are constants of integration; A, B, C, \dots are of moderate greatness; h is a quantity which is small in respect to a certain greatness l , depending *e. g.* on the dimensions of the mechanism.

S is the sum of the absolute values of p, q, r, \dots

In order to prove this proposition, the expansions (2) were substituted in the differential equations; the products and powers of the cosines and sines were written in the form of sums of cosines and constant terms; then the sum of the terms with the same expression $\cos(p\phi + q\psi + \dots)$ having as coefficient a function of h , the coefficient of each power of h may be equalized to zero.

By substituting as before we find for the coefficient of $\cos(p\phi + q\psi + \dots)$ the following expression :

$$\left[-\frac{1}{2}(pn_x + qn_y + \dots) + (p\sigma + q\tau + \dots) \right]^2 + n_x^2 + \Sigma A^2 h^2 + \dots \quad (S)$$

α
pqr...

+ other terms containing products of α 's, β 's, etc.

(the terms $\Sigma A^2 h^2$ originate from terms as *e. g.*

$$\cos^2 \phi \cos(p\phi + q\psi + \dots).$$

(2) (2)

Supposing the coefficients in the expressions σ, τ, \dots to have been calculated already, we may write the coefficient

of $\alpha \cos(p\phi + q\psi + \dots)$ in the form :

pqr...

$$\xi \equiv -\{(p-1)n_x + qn_y + \dots\} \{(p+1)n_x + qn_y + \dots\} + Dh^2 + \dots \quad (3)$$

The remaining terms which appear and which we suppose to have been arranged according to powers of h , do not

contain α in their coefficients, but products of α 's, β 's, \dots ,

which may have been calculated from preceding equations

obtained by equalizing to zero the coefficients of smaller powers of h in terms containing factors $\cos(p'\phi + q'\psi + \dots)$. We shall call the sum of the coefficients of these remaining terms P . Then we have :

$$\xi_{pqr\dots}^{(S)} \alpha_{pqr\dots}^{(S)} = P_{pqr\dots}$$

Therefore :

$$\alpha_{pqr\dots}^{(S)} = \frac{P_{pqr\dots}}{\xi_{pqr\dots}^{(S)}} \dots \dots \dots (4)$$

From (3) it follows that it is possible that ξ takes an abnormally small value ; in this case according to (4) α takes an abnormally great value. This will happen when one of the expressions

$$(p-1)n_x + qn_y + \dots \dots \dots \text{ or } \\ (p+1)n_x + qn_y + \dots \dots \dots$$

becomes small, or in other words when there exists a relation between n_x, n_y , etc. of the form :

$$p_1n_x + q_1n_y + \dots \dots \dots = \rho, \dots \dots \dots (5)$$

where p_1, q_1 , etc. are positive or negative integers, and where ρ is with respect to n_x, n_y , etc. a small quantity, which we call *residue of relation*.

When k is an integer, then

$$kp_1n_x + kq_1n_y + \dots \dots$$

is also small (we suppose k not to be very great).

If now in (3)

$$p-1 = kp_1, \quad q = kq_1, \dots \dots$$

or if

$$p+1 = kp_1, \quad q = kq_1, \dots \dots$$

then ξ becomes very small.

We see that there are in that case among the terms of higher order terms with an abnormally great coefficient in consequence of the relation (5) ; they represent vibrations of abnormally great intensity, which are called *vibrations of relation*. By vibrations of relation of the *first kind* we understand such as correspond to

$$v = kp_1 - 1, \quad q = kq_1, \dots \dots$$

The vibrations of relation of the *second kind* correspond to

$$p = kp_1 + 1, \quad q = kq_1, \dots$$

The vibrations of relation, which correspond to different values of k , are called of different *degree*.

The frequencies of the vibrations of relation of the first and second kind and of the k th degree are resp. $n_x + k\rho + Eh^2$ and $n_x - k\rho - Eh^2$, where E depends on the values of A, B , etc.

What now is found for the coordinate x is also exact for y and for all the coordinates which enter in the relation (5). So we may say :

When there exists a linear relation of the form (5) then there are a number of vibrations of higher order, which assume an abnormally great intensity; their frequencies lie in the vicinity of and on both sides of the principal frequencies which appear in the relation.

§2. Prof. Korteweg now investigates to which order of greatness the vibrations of relation will rise in general. This depends on the intensity of the motion of the mechanism, *i. e.* on h . ξ takes the value $\rho Q + Dh^2$. If now the intensity of the motion is so great that h^2 becomes of the same or of smaller order than ρ , then we may in (4) divide the numerator and the denominator by h^2 ; so α has risen two orders of greatness. This is exact for all vibrations of relation of both kinds and every degree. So we have now but to examine the function P .

The function P may rise in greatness in consequence of those terms appearing in P , which have themselves risen in greatness, *i. e.* have become of a smaller order than in the general case where no relation exists. This will not occur for the vibration of relation of the first kind and first degree. It will occur, however, for the vibration of the second kind and first degree, in consequence of terms as e, g .

$$\cos^2 \phi \cos ((p-1)\phi + q\psi + \dots).$$

This term having risen two orders, P will also rise two orders. So the term of the second kind and first degree will rise four orders, while that of the first kind and first degree will rise only two orders. The order of the former being in general $S_1 + 1$, that of the second $S_1 - 1$, both terms will rise to the same order, namely $S_1 - 3$.

Now we pass on to the vibrations of relation of the second degree. In the P function for the term of the first kind

appear among other terms those of the first degree and second kind, which have risen 4 orders. So this term rises $2+4=6$ orders. The P function for the term of second degree and second kind rises 6 orders also; so the term rises $2+6=8$ orders. Both terms of the second degree rise to the same order.

In this way we may go on. It will be clear that both terms of the same degree rise to the same order. Each following term rises 4 orders more than the former. The order of the term of the first kind and k th degree being in general kS_1-1 , the order of both terms of the k th degree will become :

$$kS_1-1-(k-1)4-2=k(S_1-4)+1.$$

§ 3. From this result it follows immediately that there exists a considerable *difference between the two cases* $S_1 \leq 4$ and $S_1 > 4$. In the latter case the vibrations of relation remain feeble in respect to the principal vibrations; the intensity is smaller for the vibrations of a higher degree.

In the case $S_1=4$, however, all the vibrations of relation reach the order of greatness of the principal vibrations. In the cases $S_1=3$ and $S_1=2$, it should seem as if the vibrations of relation would have an intensity which is great in respect to the intensity of the principal vibrations. This conclusion is not exact, as Prof. Korteweg shows by a special investigation into these cases. However, it will be clear that the development in series (2) have lost their validity completely as soon as the intensity of the motion has become so great that the vibrations of relation reach the intensity of the principal vibrations.

Therefore in the cases $S_1 \leq 4$, as soon as the motion of the mechanism has a certain intensity the developments in series can no longer represent the motion. In what follows we shall investigate what becomes of the motion in the case mentioned.

In Prof. Korteweg's paper it is shown that the developments lose their validity in the case $S_1=3$ as soon as $\frac{h}{l}$ is of the same order of greatness as $\frac{\rho}{n_x}$; in the cases $S_1=4$ and $S_1=2$ as soon as $\left(\frac{h}{l}\right)^2$ is of the same order of greatness as $\frac{\rho}{n_x}$. Therefore we shall suppose $\frac{\rho}{n_x}$ to be of order $\frac{h}{l}$ in the case $S_1=3$, and of order $\left(\frac{h}{l}\right)^2$ in the cases $S_1=4$ and

$S_1=2$. We shall examine how by the decrease of the amplitudes, or, what is the same, by the increase of ρ , the transition to the general case takes place.

The difference between the cases $S_1 > 4$ and $S_1 \leq 4$ is one of the results Prof. Korteweg arrives at. In the foregoing lines I have tried to repeat the main points of his reasoning; however, I have omitted what seemed to me to be of less importance for what will follow now. So Prof. Korteweg finds that there exists a third kind of vibrations of relation, whose frequencies lie generally in the neighbourhood of all principal frequencies, which do not appear in the relation; they behave as the vibrations of the second kind.

The investigation of the motion of a vibrating mechanism having two degrees of freedom in the cases where Prof. Korteweg's developments cease to represent this motion was the subject of my dissertation (Amsterdam, 1910). However, Prof. Korteweg had found already the nature of the motion for the case of the strict relation $n_y = 2n_x$ and the relation between ζ and ϕ for this case, which we shall deduce p. 286, as well as the special cases which for this relation may occur. This solution has been my key to the examination of the other cases, though I have during the course of my investigations directed them along other lines than were traced out in Prof. Korteweg's solution. The dissertation mentioned before was published in an abridged form (Proceedings, Amsterdam, pp. 618-635, and pp. 735-750, 1910; *Archives Néerlandaises*, series 2, vol. xv. pp. 246-283, 1910). In another paper (Proceedings, Amsterdam, pp. 742-761, 1911; *Archives Néerlandaises*, series 3 A, vol. i. pp. 185-208, 1912) I have extended the investigation to a mechanism having an arbitrary number of degrees of freedom. Some months ago in a prize-essay (not yet published) written in answer to a problem set by the Mathematical Society of Amsterdam, I have examined the envelope of systems of Lissajous' curves which occur in the question we have in view; in my dissertation the envelope had been found only for the case $n_y = 2n_x + \rho$. The subject having come so far to a conclusion it may appear desirable to publish a new summary of the problem.

§ 4. In case a relation of the form

$$p_1 n_x + q_1 n_y + \dots = \rho$$

exists, some terms in the equations of motion, after substitution of the expressions which represent in the general case the coordinates at first approximation, give rise to terms of

nearly the same period as the principal vibration, to which the equation in which the term indicated appears, relates more especially. Such terms, as is known, may be of importance, even if they are of a high order; it may occur that they are of influence even on the first approximation. In order to determine the motion at first approximation it will be necessary to include such terms in the abridged equations of motion.

Now we must notice that terms of this kind appear in the equations of motion even when no relation exists. The term xy^2 for instance will after substitution as above give rise to a term of the same period as x . That these terms are of influence on the first approximation we see from the developments (2, p. 268). The modification of the frequencies, indicated by σ, τ, \dots is the effect of the terms we refer to. These terms are of order h^3 at least.

We shall call *disturbing terms* such terms of higher order which are of importance for the first approximation. It follows from what is said above that we have to distinguish:

1st, the terms which are always disturbing, even when no relation exists; we shall call them *disturbing terms of the first kind*.

2nd, the terms which owe their disturbing property to the existing relation; we shall call them *disturbing terms of the second kind*.

In a single case ($S_1=2$) there appear terms which are disturbing in both senses.

In order to obtain the first approximation we shall admit in the differential equations of the terms of higher order only the disturbing ones, and of these terms only those of the lowest order. We shall prove that in each of the cases we have to consider, the equations of motion may be brought into this form:

$$\ddot{x} + n_x^2 x - \frac{\partial R}{\partial x} = 0,$$

$$\ddot{y} + n_y^2 y - \frac{\partial R}{\partial y} = 0,$$

.

where R is a function of x, y, \dots . To prove this, and for the deduction of the function R , we shall successively discuss the cases $S_1=3$, $S_1=4$, and $S_1=2$.

$$S_1 = 3.$$

§ 5. There are two relations to be considered, namely :

$$\begin{aligned} 1^\circ, & \quad 2n_x - n_y = \rho, \\ 2^\circ, & \quad n_x + n_y - n_z = \rho. \end{aligned}$$

When one of these relations exists there are in the equations of motion disturbing terms of the second kind of order h^2 . *e. g.* the term with xy in the first equation in case of the first relation. So the disturbing terms of the first kind can be left out, because they are of order h^3 at least, and because we admit the disturbing terms of the lowest order only.

It is clear that the disturbing terms of the second kind of order h^2 appear only in the equations resp. for x and y , and for x, y , and z . They contain no other but these coordinates. So we may say :

In the case $S_1=3$ the coordinates which appear in the relation behave at first approximation as if they were the only coordinates; the remaining coordinates behave at first approximation as if no relation existed.

It will therefore be sufficient to consider a mechanism which has 2, resp. 3 degrees of freedom.

§ 6. $2n_x - n_y = \rho$. As we have to include in the differential equations no terms of a higher order than h^2 , we have in the expressions for the kinetic energy T and for the potential energy U to take no terms of a higher order than h^3 . So we may write :

$$T = \frac{1}{2}\dot{x}^2 + \frac{1}{2}\dot{y}^2 + T_3; \quad U = \frac{1}{2}n_x^2 x^2 + \frac{1}{2}n_y^2 y^2 + U_3,$$

where U_3 is a homogeneous function of order three in x, y , and

$$T_3 = \frac{1}{2}(ax\dot{x}^2 + by\dot{x}^2 + 2cax\dot{y} + 2dy\dot{x}\dot{y} + ex\dot{y}^2 + fy\dot{y}^2).$$

The equations of Lagrange become :

$$\left\{ \begin{aligned} \ddot{x} + n_x^2 x &= -\frac{1}{2}a\dot{x}^2 - a\dot{x}\dot{x} - by\dot{x} - b\dot{x}\dot{y} - cxy\dot{y} - dyy\dot{y} + (\frac{1}{2}e - d)y\dot{y}^2 - \frac{\partial U_3}{\partial x} \\ \ddot{y} + n_y^2 y &= (\frac{1}{2}b - c)x\dot{x}^2 - c\dot{x}\dot{x} - dxy\dot{x} - e\dot{x}\dot{y} - exy\dot{y} - fy\dot{y}^2 - \frac{1}{2}f\dot{y}^2 - \frac{\partial U_3}{\partial y} \end{aligned} \right.$$

The disturbing terms are :

$$\begin{aligned} & \text{in the first equation those with } y\dot{x}, \dot{x}\dot{y}, x\dot{y}, xy; \\ & \text{,, second ,, ,, ,, } \dot{x}^2, x\dot{x}, x^2. \end{aligned}$$

Now we shall try to satisfy the equations in first approximation by

$$x = Ah \cos(n_x t + \lambda), \quad y = Bh \cos(n_y t + \mu),$$

where A, B, λ , and μ are functions of t , however in such a

manner, that \dot{A} , \dot{B} , $\dot{\lambda}$, and $\dot{\mu}$ are of order h or smaller. Then we may replace in the second member of the equations :

$$\begin{aligned} \dot{x}^2 & \text{ by } n_x^2(A^2h^2 - x^2), & \dot{y}^2 & \text{ by } n_y^2(B^2h^2 - y^2), \\ \ddot{x} & \text{ ,, } -n_x^2x, & \ddot{y} & \text{ ,, } -n_y^2y. \end{aligned}$$

If we take this into account for the disturbing terms and if we omit the non-disturbing terms, then the equations become :

$$\begin{cases} \ddot{x} + n_x^2x = (bn_x^2 + cn_y^2 + 2p)xy - b\dot{x}\dot{y}, \\ \ddot{y} + n_y^2y = (2cn_x^2 - \frac{1}{2}bn_x^2 + p)x^2. \end{cases}$$

(The terms $2paxy$ in the first equation and px^2 in the second originate from a term $-px^2y$, appearing in U_3 .)

To get rid of the term with $\dot{x}\dot{y}$ we notice that $\dot{x}\dot{y}$ by substitution of the expressions for x and y gives rise to the same disturbing term as n_xn_yxy . So we may replace $-b\dot{x}\dot{y}$ by $-bn_xn_yxy$.

We replace in the terms of higher order n_y by $2n_x$. Then the equations become :

$$\begin{cases} \ddot{x} + n_x^2x = (4cn_x^2 - bn_x^2 + 2p)xy, \\ \ddot{y} + n_y^2y = (2cn_x^2 - \frac{1}{2}bn_x^2 + p)x^2. \end{cases}$$

We may write the equations in the form :

$$\begin{cases} \ddot{x} + n_x^2x - \frac{\partial R}{\partial x} = 0, \\ \ddot{y} + n_y^2y - \frac{\partial R}{\partial y} = 0, \end{cases}$$

where, if we write $-d_2$ for $2cn_x^2 - \frac{1}{2}bn_x^2 + p$:

$$R = -d_2x^2y.$$

§ 7. $n_x + n_y - n_z = \rho$. In this case

$$U = \frac{1}{2}n_x^2x^2 + \frac{1}{2}n_y^2y^2 + \frac{1}{2}n_z^2z^2 + U_3,$$

where U_3 is a homogeneous function of order three in x , y , and z .

$$T = \frac{1}{2}\dot{x}^2 + \frac{1}{2}\dot{y}^2 + \frac{1}{2}\dot{z}^2 + \frac{1}{2}(P_{xx}\dot{x}^2 + 2P_{xy}\dot{x}\dot{y} + \dots),$$

where $e. g.$

$$P_{xy} = a_{xy}x + b_{xy}y + c_{xy}z.$$

The equations of Lagrange can be written down again. When in the terms of the 2nd order \ddot{x} , \ddot{y} , and \ddot{z} are replaced resp. by $-n_x^2x$, $-n_y^2y$, and $-n_z^2z$, then we have $e. g.$ in the

equation for x to consider as disturbing the terms with yz and $\dot{y}\dot{z}$. We may replace $\dot{y}\dot{z}$ by $n_y n_z yz$, and in the terms of the 2nd order we may put $n_x + n_y - n_z = 0$. In this way we arrive at the following form for the first equation :

$$\ddot{x} + n_x^2 x = (a_{yz} n_y n_z + b_{xz} n_x n_z - c_{xy} n_x n_y - p) yz$$

(p being the coefficient of the term xyz in U_3).

In the same way we can also simplify the two remaining equations ; we must bear in mind that in the second equation $\dot{x}\dot{z}$ must be replaced by $n_x n_z xz$, in the third equation however $\dot{x}\dot{y}$ by $-n_x n_y xy$.

The result is that the equations may be written in this form :

$$\begin{cases} \ddot{x} + n_x^2 x - \frac{\partial R}{\partial x} = 0, \\ \ddot{y} + n_y^2 y - \frac{\partial R}{\partial y} = 0, \\ \ddot{z} + n_z^2 z - \frac{\partial R}{\partial z} = 0; \end{cases}$$

where, if p' is written instead of $p - (a_{yz} n_y n_z + b_{xz} n_x n_z - c_{xy} n_x n_y)$

$$R = -p'xyz.$$

$$S_1 = 4.$$

§ 8. There are five relations to be considered, namely :

$$3n_x - n_y = \rho,$$

$$\pm n_x + 2n_y - n_z = \rho,$$

$$n_x + n_y \pm n_z - n_u = \rho.$$

In the equations of motion no term of the second order is disturbing. So the terms of the second order may in the equations be left out ; in T and U the terms of the third order may be left out. Among the terms of the third order in the equations are disturbing terms as well of the first kind as of the second kind. Terms of higher order than h^3 we may omit. The disturbing terms of the second kind are different in the different cases mentioned above ; those of the first kind are always the same. We shall first discuss these terms.

It is clear that disturbing terms of the first kind may appear in all equations and that they will contain in general all coordinates. In the equation for x disturbing terms of the first kind of order h^3 are those with : $x^3, x^2\dot{x}, x\dot{x}^2, x\dot{y}^2, xz^2, \dots, \dot{x}y^2, \dot{x}z^2, \dots, x\dot{y}\dot{y}, xz\dot{z}, \dots$

If we take again as a first approximation :

$$x = Ah \cos (n_x t + \lambda), \quad y = Bh \cos (n_y t + \mu), \dots\dots,$$

in which A, B, ... λ , μ , ... are functions of t in such a manner that \dot{A} , \dot{B} , ... $\dot{\lambda}$, $\dot{\mu}$, ... are of order h^2 or smaller, then in the terms of higher order we may substitute $-n_x^2 x$ for \ddot{x} , $-n_y^2 y$ for \ddot{y} , ..., $A^2 h^2 - n_x^2 x^2$ for \dot{x}^2 , $B^2 h^2 - n_y^2 y^2$ for \dot{y}^2 , We then retain as disturbing terms of the first kind in the first equation only those with

$$A^2 h^2 x, \quad B^2 h^2 x, \quad \dots\dots, \quad x^3, \quad xy^2, \quad \dots\dots$$

Now we replace xy^2 by $\frac{B^2 h^2}{2} x$, etc., which is permitted because they give rise to the same disturbing terms.

If we reduce in the same way the disturbing terms of the first kind in the remaining equations, we shall find that these terms are in the different equations the derivatives resp. according to x , y , of :

$$K_x x^4 + K_y y^4 + \dots\dots + M_{xx} A^2 h^2 x^2 + M_{yx} B^2 h^2 x^2 + M_{xy} A^2 h^2 y^2 + \dots\dots,$$

where the K's and M's are coefficients.

About the disturbing terms of the second kind we may make the following general observation. They appear only in the equations for those coordinates which enter in the relation, and they contain no other coordinates. So we may, in order to determine these terms, restrict ourselves respectively to mechanisms with 2, 3, or 4 degrees of freedom. We now shall discuss these terms for the different relations separately.

§ 9. $3n_x - n_y = \rho$.—In this case :

$$T = \frac{1}{2} \dot{x}^2 + \frac{1}{2} \dot{y}^2 + \frac{1}{2} P_{xx} \dot{x}^2 + P_{xy} x \dot{y} + \frac{1}{2} P_{yy} \dot{y}^2,$$

where

$$P_{xx} = \frac{1}{2} a_{xx} x^2 + b_{xx} xy + \frac{1}{2} c_{xx} y^2,$$

$$P_{xy} = \frac{1}{2} a_{xy} x^2 + b_{xy} xy + \frac{1}{2} c_{xy} y^2,$$

$$P_{yy} = \frac{1}{2} a_{yy} x^2 + b_{yy} xy + \frac{1}{2} c_{yy} y^2.$$

Further

$$U = \frac{1}{2} n_x^2 x^2 + \frac{1}{2} n_y^2 y^2 + U_4,$$

where U_4 represents a homogeneous function of degree 4 in x and y .

When in the same way as is done for the former cases the disturbing terms in the different equations are reduced,

we find that they are the derivatives, resp. according to x, y , of

$$\left\{ \left(-\frac{1}{2}b_{xx} + \frac{3}{2}a_{xy} \right) a_x^2 - l \right\} x^3 y.$$

(l is the coefficient of the term $x^3 y$ in U_4 .)

So the equations of motion may be written in this form :

$$\begin{cases} \ddot{x} + n_x^2 x - \frac{\partial R}{\partial x} = 0, \\ \ddot{y} + n_y^2 y - \frac{\partial R}{\partial y} = 0; \end{cases}$$

where, if $-f$ is written instead of $\left(-\frac{1}{2}b_{xx} + \frac{3}{2}a_{xy} \right) a_x^2 - l$:

$$R = K_x x^4 + K_y y^4 + \dots + M_{xx} A^2 h^2 x^2 + M_{yy} B^2 h^2 y^2 + \dots - f x^3 y.$$

§ 10. $\pm n_x + 2n_y - n_z = \rho$.—In this case :

$$T = \frac{1}{2} \dot{x}^2 + \frac{1}{2} \dot{y}^2 + \frac{1}{2} \dot{z}^2 + \frac{1}{2} P_{xx} \dot{x}^2 + P_{xy} \dot{x} \dot{y} + \dots,$$

where

$$P_{xx} = \frac{1}{2} a_{xx} x^2 + \frac{1}{2} b_{xx} y^2 + \frac{1}{2} c_{xx} z^2 + e_{xx} xy + f_{xx} xz + h_{xx} yz,$$

$$P_{xy} = \frac{1}{2} a_{xy} x^2 + \frac{1}{2} b_{xy} y^2 + \frac{1}{2} c_{xy} z^2 + e_{xy} xy + f_{xy} xz + h_{xy} yz.$$

Further

$$U = \frac{1}{2} n_x^2 x^2 + \frac{1}{2} n_y^2 y^2 + \frac{1}{2} n_z^2 z^2 + U_4,$$

where U_4 represents a homogeneous function of degree 4 in x, y , and z . The result is that the disturbing terms of the second kind in the different equations after reduction are the derivatives, resp. according to x, y , and z of :

$$\left(\mp n_x n_y h_{xy} \pm n_x n_z b_{xz} - \frac{1}{2} n_y^2 f_{yy} + n_y n_z e_{yz} - \rho \right) x y^2 z.$$

(ρ is the coefficient of the term $x y^2 z$ in U_4 .)

Therefore the equations of motion may be written as follows :

$$\ddot{x} + n_x^2 x - \frac{\partial R}{\partial x} = 0,$$

$$\ddot{y} + n_y^2 y - \frac{\partial R}{\partial y} = 0,$$

$$\ddot{z} + n_z^2 z - \frac{\partial R}{\partial z} = 0,$$

where, if $-f$ is written instead of $\mp n_x n_y h_{xy} \pm n_x n_z b_{xz} - \frac{1}{2} n_y^2 f_{yy} + n_y n_z e_{yz} - \rho$:

$$R = K_x x^4 + K_y y^4 + \dots + M_{xx} A^2 h^2 x^2 + M_{yy} B^2 h^2 y^2 + \dots - f x y^2 z.$$

§ 11. $\underline{n_x + n_y + n_z - n_u = \rho}$.—In this case :

$$T = \frac{1}{2}\dot{x}^2 + \frac{1}{2}\dot{y}^2 + \frac{1}{2}\dot{z}^2 + \frac{1}{2}\dot{u}^2 + \frac{1}{2}P_{xx}\dot{x}^2 + P_{xy}\dot{x}\dot{y} + \dots,$$

where

$$P_{xx} = \frac{1}{2}a_{xx}x^2 + \frac{1}{2}b_{xx}y^2 + \frac{1}{2}c_{xx}z^2 + \frac{1}{2}d_{xx}u^2 + e_{xx}xy + f_{xx}xz \\ + g_{xx}xu + h_{xx}yz + k_{xx}yu + l_{xx}zu.$$

$$P_{xy} = \frac{1}{2}a_{xy}x^2 + \frac{1}{2}b_{xy}y^2 + \frac{1}{2}c_{xy}z^2 + \frac{1}{2}d_{xy}u^2 + e_{xy}xy + f_{xy}xz \\ + g_{xy}xu + h_{xy}yz + k_{xy}yu + l_{xy}zu.$$

Further

$$U = \frac{1}{2}n_x^2x^2 + \frac{1}{2}n_y^2y^2 + \frac{1}{2}n_z^2z^2 + \frac{1}{2}n_u^2u^2 + U_4,$$

where U_4 represents a homogeneous function of order four in x, y, z and u .

The result is that the disturbing terms of the second kind in the different equations are the derivatives, resp. according to x, y, z and u of :

$$(-n_xn_yl_{xy} \mp n_xn_zk_{xz} + n_xn_uh_{xu} \mp n_yn_zg_{yz} + n_yn_u f_{yu} \pm n_zn_ue_{zu} - p)xyzu$$

(p being the coefficient of a term $xyzu$ in U_4).

Therefore the equations of motion may be written as follows :

$$\ddot{x} + n_x^2x - \frac{\partial R}{\partial x} = 0,$$

$$\ddot{y} + n_y^2y - \frac{\partial R}{\partial y} = 0,$$

$$\ddot{z} + n_z^2z - \frac{\partial R}{\partial z} = 0,$$

$$\ddot{u} + n_u^2u - \frac{\partial R}{\partial u} = 0;$$

where, if $-f$ is written instead of $-n_xn_yl_{xy} \mp n_xn_zk_{xz} + n_xn_uh_{xu} \mp n_yn_zg_{yz} + n_yn_u f_{yu} \pm n_zn_ue_{zu} - p$:

$$R = K_x x^4 + K_y y^4 + \dots + M_{xx} A^2 h^2 x^2 + M_{yx} B^2 h^2 x^2 + \dots - fxyzu.$$

$$S_1 = 2.$$

§ 12. The only relation which belongs to this case is :

$$\underline{n_x - n_y = \rho}.$$

All disturbing terms which we have to consider are of order h^3 . Here the peculiarity appears that all disturbing terms of the second kind must be regarded at the same time as disturbing terms of the first kind. So a term xy^2 gives

rise to a term with $\cos(n_x t + \lambda)$ and a term with

$$\cos\{(2n_y - n_x)t + 2\mu - \lambda\},$$

which both are disturbing in the equation for x .

The disturbing terms of the first kind are the same as for $S_1=4$.

The disturbing terms of the second kind contain no other coordinates but x and y and they appear only in the equations for x and y . Therefore we may for the discussion of these terms restrict ourselves to a mechanism of two degrees of freedom.

T and U have the same form as in the case $3n_x - n_y = \rho$ (p. 278).

The result is that the disturbing terms of the second kind in the two equations are the derivatives resp. according to x and y of :

$$n_x^2 \left\{ \frac{1}{3} \left(\frac{1}{2} b_{xx} + a_{xy} \right) x^3 y + \frac{1}{2} \left(-c_{xx} + 2b_{xy} - a_{yy} \right) x^2 y^2 + \frac{1}{3} \left(\frac{1}{2} b_{yy} + c_{xy} \right) x y^3 \right\} +$$

$$-e_2 x^3 y - e_3 x^2 y^2 - e_4 x y^3$$

(e_2, e_3 , and e_4 being the coefficients of the terms with $x^3 y, x^2 y^2$, and $x y^3$, appearing in U_4).

The equations of motion may be written in the following form :

$$\begin{cases} \ddot{x} + n_x^2 x - \frac{\partial R}{\partial x} = 0, \\ \ddot{y} + n_y^2 y - \frac{\partial R}{\partial y} = 0; \end{cases}$$

where, if

$$e_2' = e_2 - \frac{1}{3} n_x^2 \left(\frac{1}{2} b_{xx} + a_{xy} \right),$$

$$e_3' = e_3 + \frac{1}{2} n_x^2 \left(c_{xx} - 2b_{xy} + a_{yy} \right),$$

$$e_4' = e_4 - \frac{1}{3} n_x^2 \left(\frac{1}{2} b_{yy} + c_{xy} \right).$$

$$R = K_x x^4 + K_y y^4 + \dots M_{xx} A^2 h^2 x^2 + \dots - e_2' x^3 y - e_3' x^2 y^2 - e_4' x y^3.$$

§ 13. We have now brought the equations of motion for the different cases we have to consider in this form :

$$\left. \begin{aligned} \ddot{x} + n_x^2 x - \frac{\partial R}{\partial x} &= 0, \\ \ddot{y} + n_y^2 y - \frac{\partial R}{\partial y} &= 0, \\ \dots \dots \dots \end{aligned} \right\} \dots \dots \dots (6)$$

where R is a function of the coordinates x, y, \dots ; the form of R we have deduced for the different cases.

In all the cases there is at least one of the frequencies which appears in the relation (5) (p. 270) with a coefficient -1 . Let it be n_v , then the relation may be written as follows :

$$n_v = p_1 n_x + q_1 n_y + \dots - \rho.$$

We now introduce a frequency n_v' in such a way that

$$n_v = n_v' - \rho.$$

Between the frequencies n_x, n_y, \dots, n_v' exists the strict relation :

$$p_1 n_x + q_1 n_y + \dots - n_v' = 0.$$

In the differential equations we may in the terms of higher order replace n_v by n_v' . In the terms of order h this is not permitted. The frequency n_v appears in the equation

$$\ddot{v} + n_v^2 v - \frac{\partial R}{\partial v} = 0.$$

Now

$$n_v^2 = n_v'^2 - 2\rho n_v' + \rho^2.$$

By substitution of this in the equation, we may neglect the term ρ^2 . The equation takes the form

$$\ddot{v} + n_v'^2 v - 2\rho n_v' v - \frac{\partial R}{\partial v} = 0.$$

If we now admit in R a term $\rho n_v' v^2$, then the equations of motion hold the simple form, which is written down at the beginning of this section. However n_v is everywhere replaced by n_v' ; between the frequencies exists a strict relation.

§ 14. In order to integrate this system of equations, we make use of the method of the variation of the canonical constants. This means, as is known, that the equations, arising when the terms $\frac{\partial R}{\partial x}, \frac{\partial R}{\partial y}$, etc, are omitted, first are solved, in which solution $2m$ arbitrary constants appear (as the mechanism has m degrees of freedom). We then investigate what functions of the time must be the quantities just now regarded as constants, so that the expressions for the coordinates, taken in this way, represent the solution of the complete equations containing $\frac{\partial R}{\partial x}, \frac{\partial R}{\partial y}, \dots$. The equations in which $\frac{\partial R}{\partial x}, \frac{\partial R}{\partial y}, \dots$ are lacking, are solved according to the method of Hamilton-Jacobi, in order that the constants we obtain may form a canonical system.

If $\alpha_x, \alpha_y, \dots, \beta_x, \beta_y, \dots$ are the canonical constants,

then by substitution of the expressions found for x, y, \dots in R this R will become a function of the α 's, the β 's, and t . The variability of the α 's and β 's with the time is then given by

$$\left. \begin{aligned} \frac{d\alpha_x}{dt} &= \frac{\partial R}{\partial \beta_x}, & \frac{d\beta_x}{dt} &= -\frac{\partial R}{\partial \alpha_x}, \\ \frac{d\alpha_y}{dt} &= \frac{\partial R}{\partial \beta_y}, & \frac{d\beta_y}{dt} &= -\frac{\partial R}{\partial \alpha_y}. \end{aligned} \right\} \dots \dots (7)$$

§ 15. If now we solve the abridged equations

$$\left\{ \begin{aligned} \ddot{x} + n_x^2 x &= 0, \\ \ddot{y} + n_y^2 y &= 0, \\ \dots \dots \dots \end{aligned} \right.$$

arising from (6) (p. 281) by omission of the terms $\frac{\partial R}{\partial x}, \frac{\partial R}{\partial y}, \dots$ according to the method of Hamilton-Jacobi, we may arrive at

$$\left. \begin{aligned} x &= \frac{\sqrt{\alpha_x}}{n_x} \cos(n_x t + 2n_x \beta_x), \\ y &= \frac{\sqrt{\alpha_y}}{n_y} \cos(n_y t + 2n_y \beta_y), \\ \dots \dots \dots \end{aligned} \right\} \dots \dots (8)$$

We must suppose $\alpha_x, \alpha_y, \dots$ to be of order h^2 , as the amplitudes of the vibrations must be of order h .

When we perform the substitution of the expressions (8) in R we meet with two sorts of terms, namely, those which contain t explicitly and those which do not contain t explicitly. Only the terms of this last sort are of importance for the first approximation; the others we omit.

From a term $x^p y^q z^r u^s$ arises by the substitution only one term with cosine, which does not contain t (by p, q, r, s are meant the absolute values of the coefficients p, q, r, s of n_x, n_y, n_z, n_u in the relation). This term is:

$$\frac{1}{2^{S-1}} \cdot \frac{\sqrt{\alpha_x^p \alpha_y^q \alpha_z^r \alpha_u^s}}{n_x^p n_y^q n_z^r n_u^s} \cos 2(pn_x \beta_x + qn_y \beta_y + rn_z \beta_z + sn_u \beta_u),$$

where $S = \bar{p} + \bar{q} + \bar{r} + \bar{s}$.

The term $\rho n_v^2 v^2$ appearing in R (§ 13, p. 281) gives rise to a term $\frac{\rho}{2n_v} \alpha_v$.

The terms $K_x x^4, K_y y^4, \dots, M_{xx} A^2 h^2 x^2, M_{yx} B^2 h^2 x^2, \dots$ (in these latter terms we must first replace $A^2 h^2, B^2 h^2, \dots$

by $\frac{\alpha_x}{n_x^2}, \frac{\alpha_y}{n_y^2}, \dots$) give rise to a homogeneous quadratic function of the α 's $\chi_2(\alpha_1, \alpha_2, \dots, \alpha_m)$.

We must, however, make an exception as to the case $S_1=2$. The terms $K_x x^4, K_y y^4, \dots, M_{xx} A^2 h^2, M_{yx} B^2 h^2, \dots$ do not give any difficulty. The term $x^2 y^2$ gives, besides a term with cosine, rise to a constant term. The terms $x^3 y$ and $x y^3$ give rise resp. to terms with

$$\alpha_x \sqrt{\alpha_x \alpha_y} \cos 2(n_x \beta_x - n_y \beta_y) \quad \text{and} \quad \alpha_y \sqrt{\alpha_x \alpha_y} \cos 2(n_x \beta_x - n_y \beta_y).$$

Therefore R takes in the different cases the following form :

$$\begin{cases}
 S_1=3 \left\{ \begin{array}{l}
 2n_x - n_y = \rho \quad R = \frac{\rho}{2n_y} \alpha_y - \frac{d_2}{4n_x^2 n_y} \alpha_x \sqrt{\alpha_y} \cos 2(2n_x \beta_x - n_y \beta_y). \\
 n_x + n_y - n_z = \rho \quad R = \frac{\rho}{2n_z} \alpha_z - \frac{p'}{4n_x n_y n_z} \sqrt{\alpha_x \alpha_y} \alpha_z \cos 2(n_x \beta_x + n_y \beta_y - n_z \beta_z).
 \end{array} \right. \\
 \\
 S_1=4 \left\{ \begin{array}{l}
 3n_x - n_y = \rho \quad R = \chi_2(\alpha_x, \alpha_y, \dots, \alpha_m) + \frac{\rho}{2n_y} \alpha_y - \frac{e_2}{8n_x^3 n_y} \alpha_x \sqrt{\alpha_x \alpha_y} \cos 2(3n_x \beta_x - n_y \beta_y). \\
 \pm n_x + 2n_y - n_z = \rho \quad R = \chi_2(\alpha_x, \alpha_y, \dots, \alpha_m) + \frac{\rho}{2n_z} \alpha_z - \frac{p'}{8n_x n_y^2 n_z} \alpha_y \sqrt{\alpha_x \alpha_z} \cos 2(\pm n_x \beta_x + 2n_y \beta_y - n_z \beta_z). \\
 n_x + n_y \pm n_z - n_u = \rho \quad R = \chi_2(\alpha_x, \alpha_y, \dots, \alpha_m) + \frac{\rho}{2n_u} \alpha_u - \frac{p'}{8n_x n_y n_z n_u} \sqrt{\alpha_x \alpha_y \alpha_z \alpha_u} \cos 2(n_x \beta_x + n_y \beta_y \pm n_z \beta_z - n_u \beta_u).
 \end{array} \right. \\
 \\
 S_1=2 \left\{ \begin{array}{l}
 n_x - n_y = \rho \quad R = \chi_2(\alpha_x, \alpha_y, \dots, \alpha_m) + \frac{\rho}{2n_y} \alpha_y - \frac{f}{8n_x^2 n_y^2} \alpha_x \alpha_y \cos 4(n_x \beta_x - n_y \beta_y) - \frac{3}{8} \sqrt{\alpha_x \alpha_y} (e_2' \alpha_x + e_4' \alpha_y) \cos 2(n_x \beta_x - n_y \beta_y).
 \end{array} \right.
 \end{cases}$$

§ 16. We can make now the following general observation. The β 's appear only under the sign cosine ; the coefficients of $n_x \beta_x, n_y \beta_y, \dots$ in the expressions between brackets are the same as the coefficients in the relation (5) (p. 270). We put now :

$$\phi \equiv 2(p n_x \beta_x + q n_y \beta_y + \dots). \dots \dots (9)$$

As

$$\frac{\partial R}{\partial \beta_x} = \frac{\partial R}{\partial \beta_y} = \dots$$

we have, according to (7) (p. 283):

$$\frac{d\alpha_x}{pn_x} = \frac{d\alpha_y}{qn_y} = \dots \dots \dots (10)$$

This enables us to express the $m \alpha$'s by the help of one new variable ζ only; this new variable ζ we will choose in such a way that each of the members of (10) is equal to $R_0^2 h^2 \frac{d\zeta}{dt}$, where R_0 is a constant of integration of moderate value.

Now we have

$$\alpha_x = pn_x R_0^2 h^2 \zeta, \quad \alpha_y = qn_y R_0^2 h^2 (C_2 + \zeta), \dots \dots \dots (11)$$

where C_2, \dots are $(m-1)$ constants of integration.

As in (10) the sum of the denominators is zero (§ 13, p. 282), the sum of the numerators is also zero. Therefore

$$\frac{d\alpha_x}{dt} + \frac{d\alpha_y}{dt} + \dots = 0.$$

Or

$$\alpha_x + \alpha_y + \dots = \text{constant.} \dots \dots \dots (12)$$

In case $m=2$, then $qn_y' = -pn_x$. In this case we have

$$\alpha_x = pn_x R_0^2 h^2 \zeta, \quad \alpha_y = -pn_x R_0^2 h^2 (C + \zeta).$$

Introducing ζ' instead of ζ and R_0' instead of R_0 in such a way that

$$\zeta = -C_2 \zeta', \quad R_0^2 = -\frac{n_x}{\rho C_2} R_0'^2,$$

we get, after omitting the accents again :

$$\alpha_x = R_0^2 n_x^2 h^2 \zeta, \quad \alpha_y = R_0^2 n_x^2 h^2 (1 - \zeta). \dots \dots (13)$$

§ 17. When we differentiate R according to the time, we get

$$\frac{dR}{dt} = \frac{\partial R}{\partial \alpha_x} \cdot \frac{d\alpha_x}{dt} + \frac{\partial R}{\partial \beta_x} \cdot \frac{d\beta_x}{dt} + \frac{\partial R}{\partial \alpha_y} \cdot \frac{d\alpha_y}{dt} + \frac{\partial R}{\partial \beta_y} \cdot \frac{d\beta_y}{dt} + \dots + \frac{\partial R}{\partial t}.$$

From (7) (p. 283) we deduce

$$\frac{dR}{dt} = \frac{\partial R}{\partial t}.$$

If now R does not contain t explicitly (this condition is satisfied in the different cases we have to consider), then

$$R = \text{constant} \dots \dots \dots (14)$$

is an integral of system (7) (p. 283).

By substitution of (11) or (13) in (14), we get a relation between ζ and ϕ , which in the different cases has this form :

$$\begin{cases}
 S_1=3 \left\{ \begin{array}{l}
 2n_x - n_y = \rho, \quad \zeta \sqrt{1-\zeta} \cos \phi = k + \rho' \zeta, \quad \left(\rho' = -\frac{\rho n_y}{d_2 R_0 h} \right). \\
 n_x + n_y - n_z = \rho, \quad \sqrt{\zeta(\zeta - C_2)(C_3 - \zeta)} \cos \phi = k + \rho' \zeta, \\
 \left(\rho' = -\frac{2\sqrt{n_x n_y n_z \rho}}{R_0 \rho' h} \right).
 \end{array} \right. \\
 S_1=4 \left\{ \begin{array}{l}
 3n_x - n_y = \rho, \quad \zeta \sqrt{\zeta(1-\zeta)} \cos \phi = p \zeta^2 + q \zeta + r. \\
 \pm n_x + 2n_y - n_z = \rho, \quad \zeta \sqrt{(C_1 - \zeta)(C_3 - \zeta)} \cos \phi = p \zeta^2 + q \zeta + r. \\
 n_x \pm n_y + n_z - n_u = \rho, \quad \sqrt{\zeta(C_1 - \zeta)(C_2 - \zeta)(C_3 \pm \zeta)} \cos \phi = p \zeta^2 + q \zeta + r.
 \end{array} \right. \\
 S_1=2 \quad n_x - n_y = \rho, \quad \zeta(1-\zeta) \cos^2 \phi + l \sqrt{\zeta(1-\zeta)} \cos \phi = p \zeta^2 + q \zeta + r.
 \end{cases}$$

§ 18. When, in the first equation of system (7) (§ 14),

$$\frac{d\alpha_x}{dt} = \frac{\partial R}{\partial \beta_x},$$

we replace the α 's by the expressions (11) or (13) of § 16, then according to the form of R (§ 15), the equation takes this form

$$\frac{d\zeta}{dt} = f(\zeta) \sin \phi. \dots \dots \dots (15)$$

This regards the cases $S_1=3$ and $S_1=4$; for each of the relations $f(\zeta)$ has another form.

In the case $S_1=2$ it takes this form :

$$\frac{d\zeta}{dt} = f_1(\zeta) \sin 2\phi + f_2(\zeta) \sin \phi. \dots \dots (16)$$

If now we eliminate ϕ between (14) and (15) or (16), then $\frac{d\zeta}{dt}$ is known as a function of ζ , and ζ may be found as a function of t ; from (11) or (13) we may find the α 's, and from (14) ϕ . Thereupon $\frac{d\beta_x}{dt}, \frac{d\beta_y}{dt}, \dots$ in (7) (p. 283) are known as functions of t , and β_x, β_y, \dots may be

found. The problem is reduced to quadratures. It is easy to see that in the cases $S_1=3$ and $S_1=4$ the coordinates with the help of elliptic functions can be expressed in terms of the time*.

§ 19. In § 5 (p. 275) we have found that in the case $S_1=3$ the coordinates which appear in the relation behave as if they were the only coordinates; the remaining coordinates behave as if no relation existed.

This is not true for the cases $S_1=4$ and $S_1=2$. In these cases the function R contains in general all α 's. So all β 's are functions of t . The function R contains only the β 's related to those coordinates which enter in the relation. Therefore the α 's related to the remaining coordinates are constants. These coordinates feel the influence of the relation only in their phase. The coordinates which appear in the relation feel also the influence of the remaining coordinates; this influence consists in a modification of the frequencies.

§ 20. The expressions (15) and (16) for $\frac{d\xi}{dt}$ show us that $\frac{d\xi}{dt}$ (and, according to (11), also $\frac{d\alpha_x}{dt}, \frac{d\alpha_y}{dt}, \dots$) are zero when $\sin \phi=0$. So in general the α 's will vary periodically between two limits. The extreme values of the α 's will be known when the values of ξ are known for which $\sin \phi=0$. The equation, from which these values of ξ are found, is obtained by putting in (14) $\cos \phi$ equal to ± 1 . This equation is in the case $S_1=3$ of the third, in the cases $S_1=4$ and $S_1=2$ of the fourth degree. In the case $S_1=2$, $\frac{d\xi}{dt}$ may also become zero for $\cos \phi = -\frac{f_2(\xi)}{2f_1(\xi)}$.

§ 21. We may remark now that the motion of the mechanism, in case an approximate relation between the principal frequencies exists, is wholly different from the general case in which no relation exists. In the latter case at first approximation the principal coordinates are independent of one another; each principal coordinate performs an harmonic vibration of a constant amplitude; in order to take into account the terms of higher order we have but to add to the motion of each principal coordinate motions of a very small amplitude (if compared with the principal vibration itself). In

* In my dissertation (Amsterdam, 1910) these calculations have been executed for the relation $2n_x - n_y = \rho$.

the former case the principal coordinates are no longer independent of each other; the amplitudes of the principal vibrations vary with the time; so the quantities of energy belonging to each of the coordinates vary also with the time; (12, p. 285) expresses that the whole of the energy is constant.

When a relation exists, then the form of motion of the mechanism will constantly alter, because the α 's and the β 's vary with the time. However, after a certain lapse of time the configuration will be the same as before. In order to investigate the forms of motion, which will successively occur, it will be sufficient to discuss the relation between ζ and ϕ . To this aim we shall represent this relation in polar coordinates with ϕ as polar angle, ζ (or $\sqrt{\zeta}$ or $\sqrt{1-\zeta}$) as radius vector. The curves are symmetrical with respect to the origin of angles. The form of the curves changes with the value of the coefficients in the second member of the equation. The intersecting points with the origin of angles are given by $\sin \phi = 0$. Now there are, letting alone the special cases, two different cases:

1°. For the extreme values of ζ , ϕ has the same value; then ϕ varies between two limits. *Case of libration.*

2°. For the extreme values of ζ , ϕ is one time 0, one time π ; ϕ takes all values. *General case.*

It is clear that there are two special cases. The one is to be considered as the limit case of the libration; the extreme values of ζ have coincided; $\sin \phi$ (or $\cos \phi$) is zero invariably. The form of motion does not alter. *Periodic case.*

To a same value of the coefficients two closed curves may correspond. For a special value of the coefficients these curves may have a common point. Then the motion approaches asymptotically to the form of motion indicated by this point. *Asymptotic case.*

§ 22. We shall apply this to the different cases.

$$S_1 = 3.$$

$\frac{2n_x - n_y}{2} = \rho$. We suppose first $\rho = 0$; then we have the case of the strict relation. The relation between ζ and ϕ runs:

$$\zeta \sqrt{1-\zeta} \cos \phi = k \quad (\sqrt{1-\zeta} \text{ we take as radius vector}).$$

For $k > 0$ the ζ - ϕ curves lie to the right of the straight line $\phi = \frac{\pi}{2}$, for $k < 0$ to the left of it; $k = 0$ furnishes degeneration into the straight line $\phi = \frac{\pi}{2}$, the point $\zeta = 1$ and

the circle $\zeta=0$. By the maximal positive and negative value of k ($k = \pm \frac{2}{9}\sqrt{3}$) the curve has contracted into an isolated point. So we have in general the case of libration, for $k=0$ the asymptotic, and for $k = \pm \frac{2}{9}\sqrt{3}$ the periodic form of motion. The general form of motion does not occur. (Fig. 1, Pl. VII.)

Now we suppose $\rho \neq 0$. Then

$$\zeta\sqrt{1-\zeta} \cos \phi = k + \rho'\zeta.$$

We investigate the site and shape of the ζ - ϕ curves for positive values of ρ' and for all possible values of k .

For $k=0$ there is degeneration into the circle $\zeta=0$, and a straight line normal to the origin of the angles at a distance ρ' from pole O (the degeneration points to an asymptotic form of motion).

We have two cases now : $\rho' < 1$ and $\rho' > 1$.

$\rho' < 1$. Let us now investigate the shape of the curves for different values of k . For $k > 0$ they lie to the right of the straight line just mentioned (case of libration); for increasing value of k they contract more and more until for the maximal value of k , belonging to a certain value of ρ' , we get an isolated point (periodic form of motion). If $-\rho' < k < 0$ the curves surround point O (general form of motion); if $k = -\rho'$ we have a curve through O, for $k < -\rho'$ they lie to the left of O (case of libration); for the minimal value of k we again get an isolated point (periodic form of motion). (Fig. 2.)

For increasing values of ρ' the straight line separating the domains $k > 0$ and $k < 0$ moves to the right. The domain $k > 0$ (the domain of the former case of libration) becomes smaller and vanishes for $\rho' = 1$. For $\rho' > 1$ we therefore have curves surrounding O and curves to the left of O only. When ρ' increases still more the remaining isolated point approaches to O (the domain of the latter case of libration becomes smaller) and the curves farther from O approach to circles. The general form of motion becomes preponderant more and more.

§ 23. $n_1 + n_2 - n_3 = \rho$. We take ζ as radius vector. We take first the case of the strict relation. Therefore :

$$\sqrt{\zeta(\zeta - C_2)(C_3 - \zeta)} \cos \phi = k.$$

The ζ - ϕ curves remain to the right or to the left of O according as k is positive or negative (in general we have the case of libration). For the maximal value of k^2 belonging

to given values of C_2 and C_3 the curves have contracted into an isolated point (periodic form of motion). For $k=0$ degeneration takes place into the point $\zeta=0$, the circles $\zeta=C_2$ and $\zeta=C_3$ and the straight line $\cos \phi=0$ (asymptotic form of motion). For $C_2=C_3$ then of necessity $k=0$. (Fig. 3.)

Now we suppose $\rho \neq 0$. Therefore

$$\sqrt{\zeta(\zeta-C_2)(C_3-\zeta)} \cos \phi = \rho'(k-\zeta).$$

We may imagine ρ' to be positive. We give to C_2 and C_3 constant values and we find for a certain value of ρ' the forms of the curves satisfying the different possible values of k . We then see how this system of curves varies when ρ' passes through all values from very little to very large.

For every value of ρ' three cases can be distinguished :

$k > C_3$. As ζ remains smaller than C_3 , the second member, so also $\cos \phi$, remains positive. Curves on the right of O (Case of libration).

$k < C_2$. Curves on the left of O (Case of libration).

$C_2 < k < C_3$. The second member, therefore also $\cos \phi$, becomes zero for $\zeta=k$. Curves which surround O (General form of motion).

The domains of the plane occupied by these different kinds of curves are bounded by the curves which correspond to $k=C_3$ and $k=C_2$. For these values of k a degeneration takes place.

For $k=C_2$ in

$$\zeta=C_2 \text{ and } \sqrt{\zeta(C_3-\zeta)} \cos \phi = -\rho' \sqrt{\zeta-C_2}.$$

The latter curve lies on the left of O, it begins and ends in the points: $\zeta=C_2, \phi = \pm \frac{\pi}{2}$.

For $k=C_3$ in

$$\zeta=C_3 \text{ and } \sqrt{\zeta(\zeta-C_2)} \cos \phi = \rho' \sqrt{C_3-\zeta}.$$

The latter curve lies on the right of O ; it begins and ends in the points: $\zeta=C_3, \phi = \pm \frac{\pi}{2}$.

The degenerated curves point to asymptotic forms of motion.

To investigate how the system of curves varies when ρ' is changed, it is sufficient to investigate the variation of the degenerated curves. The result is, that the domain of the

curves surrounding O (general form of motion) is very small for small values of ρ' and it extends according as ρ' increases, so that those curves are most important for great values of ρ' . Furthermore, we notice that according as ρ' increases the curves surrounding O approach to circles with O as centre.

For each value of ρ' we get for the maximal and minimal value of k an isolated point on the axis of the angles (periodic form of motion).

Fig. 4 gives some curves for a rather small value of ρ' , fig. 5 for a rather great value of ρ' ; the — — — lines indicate the degenerated curves.

$$S_1=4.$$

§ 24. $3n_x - n_y = \rho$. The relation between ζ and ϕ runs :

$$\zeta\sqrt{\zeta(1-\zeta)} \cos \phi = p\zeta^2 + q\zeta + r.$$

In fig. 6 the different possibilities have been represented, ζ is taken as radius vector. The general case is indicated by a continuous line, the case of libration too. In the periodic case $\sin \phi = 0$, and in the asymptotic case the form of motion approaches to $\sin \phi = 0$.

$$\begin{array}{l} \underline{n_x + 2n_y - n_z = \rho}, \quad \underline{-n_x + 2n_y - n_z = \rho}, \quad \underline{n_x + n_y + n_z - n_u = \rho}, \\ \underline{n_x + n_y - n_z - n_u = \rho}. \end{array}$$

The relations between ζ and ϕ are to be found in § 17. In case of the first relation ζ remains between 0 and the smaller of C_1 and C_2 , in case of the second relation between 0 and the smaller of C_1 and C_3 , in case of the third relation between 0 and the smallest of C_1 , C_2 , and C_3 , in case of the fourth between 0 and the smaller of C_1 and C_2 . For the rest the ζ - ϕ curves are of quite the same kind as in the case of the relation $3n_x - n_y = \rho$.

$$S_1=2.$$

§ 25. We shall restrict ourselves to the case $l=0, p=-q$. Then the relation between ζ and ϕ (§ 17) runs :

$$\zeta(1-\zeta) \cos^2 \phi = q\zeta(1-\zeta) + r.$$

In figs. 7-13 (Pl. VII.) ζ is taken as radius vector. Every one of these figures corresponds to a certain value of q ; in each of the figures the curves correspond to different values of r .

Fig. 7. $q = -\infty$.

- $r = -\frac{1}{4}q$. Circle $\zeta = \frac{1}{2}$.
 $-\frac{1}{4}q < r < 0$. Two circles with O as centre.
 $r = 0$. Circle $\zeta = 1$, isolated point $\zeta = 0$.

Fig. 8. $-\infty < q < 0$.

- $r = -\frac{1}{4}(q-1)$. Isolated points $\zeta = \frac{1}{2}$, $\sin \phi = 0$.
 $-\frac{1}{4}q < r < -\frac{1}{4}(q-1)$. A curve to the right and a curve to the left of O.
 $r = -\frac{1}{4}q$. Curve with double points in $\zeta = \frac{1}{2}$, $\cos \phi = 0$.
 $0 < r < -\frac{1}{4}q$. Two curves surrounding O.
 $r = 0$. Circle $\zeta = 1$, isolated point $\zeta = 0$.

Fig. 9. $q = 0$.

- $r = \frac{1}{4}$. Isolated points $\zeta = \frac{1}{2}$, $\sin \phi = 0$.
 $0 < r < \frac{1}{4}$. A curve to the right and a curve to the left of O.
 $r = 0$. Circle $\zeta = 1$, isolated point $\zeta = 0$.

Fig. 10. $0 < q < 1$.

- $r = -\frac{1}{4}(q-1)$. Isolated points $\zeta = \frac{1}{2}$, $\sin \phi = 0$.
 $0 < r < -\frac{1}{4}(q-1)$. A curve to the right and a curve to the left of O.
 $r = 0$. Two straight lines passing through O.
 $-\frac{1}{4}q < r < 0$. A curve below and a curve above O.
 $r = -\frac{1}{4}q$. Isolated points $\zeta = \frac{1}{2}$, $\cos \phi = 0$.

Fig. 11. $q = 1$.

- $r = 0$. Origin of angles, circle $\zeta = 1$.
 $-\frac{1}{4}q < r < 0$. A curve below and a curve above O.
 $r = -\frac{1}{4}q$. Isolated points $\zeta = \frac{1}{2}$, $\cos \phi = 0$.

Fig. 12. $1 < q < \infty$.

- $r = 0$. Isolated point $\zeta = 0$, circle $\zeta = 1$.
 $-\frac{1}{4}(q-1) < r < 0$. Two curves surrounding O.
 $r = -\frac{1}{4}(q-1)$. Curve with double points in $\zeta = \frac{1}{2}$, $\sin \phi = 0$.
 $-\frac{1}{4}q < r < -\frac{1}{4}(q-1)$. A curve below and a curve above O.
 $r = -\frac{1}{4}q$. Isolated points $\zeta = \frac{1}{2}$, $\cos \phi = 0$.

Fig. 13. $q = \infty$.

The same as for $q = -\infty$.

Geometrical representation of the motion of the mechanism.

We may obtain a geometrical representation of the motion by making use of a representative point, which moves in a space of 2, 3, or 4 dimensions, if the mechanism we have in view has resp. 2, 3, or 4 degrees of freedom. From what is said, § 5 and § 19, it follows that it is not necessary to consider mechanisms with more than 4 degrees of freedom.

Mechanism with two degrees of freedom.

§ 26. For an arbitrary mechanism with two degrees of freedom we may regard as a representative point the horizontal projection of a material point which moves without friction yet under the influence of gravitation on a given surface in the vicinity of its lowest point. The surface has positive curvature in the vicinity of this point O, plane XY is the tangential plane in O, and the XZ- and YZ-planes are the principal sections of the surface in that point, whilst the Z-axis is supposed positive upwards.

Then we have :

$$U = gz = c_1x^2 + c_2y^2 + d_1x^3 + d_2x^2y + d_3xy^2 + d_4y^3 + e_1x^4 + e_2x^3y + e_3x^2y^2 + e_4xy^3 + e_5y^4 + \dots\dots\dots,$$

where

$$c_1 = \frac{1}{2}n_x^2 = \frac{g}{2R_x}; \quad c_2 = \frac{1}{2}n_y^2 = \frac{g}{2R_y},$$

R_x and R_y being the principal radii of curvature of the surface in O.

The expression for the kinetic energy takes the form :

$$T = \frac{1}{2} \left\{ \dot{x}^2 + \dot{y}^2 + \left(\frac{\partial z}{\partial x} \dot{x} + \frac{\partial z}{\partial y} \dot{y} \right)^2 \right\}.$$

§ 27. The motion of the representative point is given by (8, p. 283; 13, p. 285) :

$$x = R_0 h \sqrt{\zeta} \cos(n_x t + 2n_x \beta_x),$$

$$y = \frac{1}{\gamma} R_0 h \sqrt{1 - \zeta} \cos(\gamma n_x t + 2\gamma n_x \beta_y)$$

where, according to § 17, a relation exists between ζ and ϕ :

$$f(\zeta, \phi) = 0.$$

ϕ is written instead of $2\gamma n_x(\beta_x - \beta_y)$.

ζ , β_1 , and β_2 have for every moment a definite value; these values determine a certain Lissajous curve. This curve we

shall call the osculating curve for the moment indicated, which name is in use in the theory of disturbances (see, among others, H. Poincaré, *Leçons de Mécanique céleste*, vol. i. p. 90). As ζ , β_1 , and β_2 vary slowly, the osculating curve will also vary; we shall examine the system of Lissajous curves described.

We take a new unit of length, having $R_0 h$ old units; then the amplitudes become resp. $\sqrt{\zeta}$ and $\frac{1}{\gamma} \sqrt{1-\zeta}$. We see immediately that the vertices of the rectangles in which the Lissajous curves are described lie on the circumference of an ellipse with its great axis along the X-axis; the half of the great axis is the new unit of length; the half of the small axis is the γ th part of the new unit of length.

We may for each osculating curve choose the origin of time in such a way that for $t=0$ the moving point has its greatest deviation to the right. The difference in phase is $2\gamma n_x(\beta_x - \beta_y) = \phi$, when the phase is calculated from this same moment. Taking at last a new unit of time, we may write the equations in this form:

$$\left. \begin{aligned} x &= \sqrt{\zeta} \cos t \\ y &= \frac{1}{\gamma} \sqrt{1-\zeta} \cos(\gamma t - \phi) \end{aligned} \right\} \dots \dots (17)$$

Every osculating curve is described in 2π new units of time.

The relation between ζ and ϕ has the form:

$$\zeta^{\frac{\gamma}{2}}(1-\zeta)^{\frac{1}{2}} \cos \phi = f(\zeta), \dots \dots (18)$$

where $f(\zeta)$ has for each of the cases $\gamma=1$ ($S_1=2$), $\gamma=2$ ($S_1=3$), and $\gamma=3$ ($S_1=4$) another form, namely:

$$\begin{aligned} \gamma=2 & \quad f(\zeta) \equiv k + \rho' \zeta. \\ \gamma=3 & \quad f(\zeta) \equiv p \zeta^2 + q \zeta + r. \\ \gamma=1 & \quad f(\zeta) \equiv -\frac{1}{2} l \pm \sqrt{p \zeta^2 + q \zeta + r + \frac{1}{4} l^2}. \end{aligned}$$

§ 28. The shape of a Lissajous curve depends on the ratio of the periods, the ratio of the amplitudes, and the difference in phase. The shape of the curves for the ratio $\frac{1}{1}$, $\frac{1}{2}$, $\frac{1}{3}$ of the periods is well known for arbitrary values of ϕ as well as for the particular values of ϕ for which $\sin \phi=0$ or $\cos \phi=0$. For $\sin \phi=0$ we obtain the curves which are described in both directions alternately; we shall call them Lissajous double curves. That the condition $\sin \phi=0$ is

necessary for such a curve may be proved as follows : In a double curve $\cos t$ and $\cos(\gamma t - \phi)$ take the same value for two different values of t ; for this value of t $\sin t$ and $\sin(\gamma t - \phi)$ have a different sign. Let t_0 be one of the values for t , then the other must be $t' = 2r_1\pi - t_0$, and in the same time $\gamma t' - \phi = 2r_2\pi - \gamma t_0 + \phi$, where r_1 and r_2 are integers. From this it follows that $\phi = (r_1\gamma - r_2)\pi$; therefore $\sin \phi = 0$. That the condition $\sin \phi = 0$ is sufficient for such a curve follows directly by substituting $\phi = r\pi$ in the expression for y .

For $\cos \phi = 0$ the X-axis and Y-axis are lines of symmetry.

Now in § 20 we have found that in general ζ varies periodically between two extremes ; the vertices of the rectangles, in which the osculating curves are described, move to and fro along the ellipse between two limits ; at the same time ϕ varies. In the cases $S_1=3$ and $S_1=4$ $\frac{d\zeta}{dt} = 0$ for $\sin \phi = 0$ (§ 20, p. 287) ; so in the extreme rectangles Lissajous double curves are described. However, in the case $S_1=2$ $\frac{d\zeta}{dt} = 0$ for $\sin \phi = 0$ or (in case $l=0$ in § 17) for $\cos \phi = 0$ (§ 20, p. 287) ; so here it may occur that in one of the extreme rectangles or in both a symmetric Lissajous curve is described.

We have seen (§ 21) that there are two different special cases :

1°. The periodic case. ζ remains constant. In the cases $\gamma=2$ and $\gamma=3$ $\sin \phi = 0$; the same curve, a Lissajous double curve, is continually described. In the case $\gamma=1$ $\sin \phi = 0$ or $\cos \phi = 0$; a double curve or a symmetric curve is continually described.

2°. The asymptotic case. To the form of motion, just described, the motion approaches asymptotically.

Envelope of the system of Lissajous curves.*

§ 29. In order to find the envelope of the system of curves

$$x = F_1(\zeta, \phi, t), \quad y = F_2(\zeta, \phi, t), \quad \phi = \chi(\zeta),$$

we may regard that envelope as the locus of the intersecting points of a certain curve, given by a certain value of ζ , with

* In my prize essay was only discussed the envelope for system (17, § 27). Prof. Korteweg, being one of the examiners, proved that some of my results remained true for the more general system (19). Of his observations I have made use in the following pages.

the curve corresponding to a value $\zeta + \Delta\zeta$ for ζ . So we have to eliminate $\Delta\zeta$, $\Delta\phi$, and Δt between :

$$\begin{aligned} \frac{\partial x}{\partial \zeta} \Delta\zeta + \frac{\partial x}{\partial \phi} \Delta\phi + \frac{\partial x}{\partial t} \Delta t &= 0, \\ \frac{\partial y}{\partial \zeta} \Delta\zeta + \frac{\partial y}{\partial \phi} \Delta\phi + \frac{\partial y}{\partial t} \Delta t &= 0, \\ \Delta\phi &= \chi'(\zeta) \Delta\zeta. \end{aligned}$$

The result is the following equation :

$$\frac{\partial y}{\partial t} \cdot \frac{\partial x}{\partial \zeta} - \frac{\partial x}{\partial t} \cdot \frac{\partial y}{\partial \zeta} + \left[\frac{\partial y}{\partial t} \cdot \frac{\partial x}{\partial \phi} - \frac{\partial x}{\partial t} \cdot \frac{\partial y}{\partial \phi} \right] \cdot \frac{d\phi}{d\zeta} = 0.$$

If we eliminate ζ , ϕ , and t between this equation and the equations written down at the beginning of this section, the result is the equation of the envelope.

§ 30. We start from a system of Lissajous curves which is more general than the system (17) of § 27, namely

$$x = f_1(\zeta) \cos t, \quad y = f_2(\zeta) \cos(\gamma t - \phi), \quad \cos \phi = \psi(\zeta). \quad (19)$$

By substitution of these expressions for x and y , the equation of the envelope takes this form :

$$\begin{aligned} \gamma f_2'(\zeta) f_1'(\zeta) \cos t \sin(\gamma t - \phi) \sin \phi - f_1'(\zeta) f_2'(\zeta) \sin t \cos(\gamma t - \phi) \sin \phi \\ + f_1(\zeta) f_2(\zeta) \sin t \sin(\gamma t - \phi) \psi'(\zeta) = 0. \quad (20) \end{aligned}$$

§ 31. This equation is satisfied by $\sin \phi = 0$, $\sin t = 0$. Now the double curves correspond to $\sin \phi = 0$; the ends of these curves (meant in a dynamical sense) correspond to $\sin t = 0$. Therefore :

The ends of the double curves lie on the envelope.

The tangential line of the envelope in a certain point coincides with the tangential line of the osculating curve, which in the point considered is enveloped. Therefore we have for the envelope :

$$\frac{dy}{dx} = \frac{\gamma f_2(\zeta) \sin(\gamma t - \phi)}{f_1(\zeta) \sin t} \dots \dots \dots (21)$$

So we see that $\frac{dy}{dx}$ takes the indefinite form for $\sin t = 0$ (this involves $\sin \gamma t = 0$) and $\sin \phi = 0$, in other words, for the ends of the double curves. We have now to investigate in what manner the ends of the double curves behave in the envelope, for instance, the point $\phi = 0$, $t = 0$. We have for this point :

$$\frac{dy}{dx} = \gamma \frac{f_2(\zeta)}{f_1(\zeta)} \left(\gamma - \frac{d\phi}{dt} \right).$$

In order to determine $\frac{d\phi}{dt}$ we have to differentiate (20) twice ; in the result we substitute $\sin t=0$, $\cos t=1$, $\sin \phi=0$, $\cos \phi=1$, $\sin(\gamma t-\phi)=0$, $\cos(\gamma t-\phi)=1$. Then we get :

$$\gamma f_2(\zeta) f_1'(\zeta) \frac{d\phi}{dt} \left(\gamma - \frac{d\phi}{dt} \right) - f_1(\zeta) f_2'(\zeta) \frac{d\phi}{dt} + f_1(\zeta) f_2(\zeta) \left(\gamma - \frac{d\phi}{dt} \right) \psi'(\zeta) = 0.$$

Writing $\gamma - \left(\gamma - \frac{d\phi}{dt} \right)$ instead of $\frac{d\phi}{dt}$, where it appears as a factor, we get a quadratic equation in $\gamma - \frac{d\phi}{dt}$, namely:

$$-\gamma f_2(\zeta) f_1'(\zeta) \left(\gamma - \frac{d\phi}{dt} \right)^2 + \{ \gamma^2 f_2(\zeta) f_1'(\zeta) + f_1(\zeta) f_2'(\zeta) + f_1(\zeta) f_2(\zeta) \psi'(\zeta) \} \left(\gamma - \frac{d\phi}{dt} \right) - \gamma f_1(\zeta) f_2'(\zeta) = 0.$$

Therefore the ends of the double curves are double points in the envelope.

When $\left(\frac{dy}{dx} \right)_1$ and $\left(\frac{dy}{dx} \right)_2$ are the values of $\frac{dy}{dx}$ in the double point, then

$$\begin{aligned} \left(\frac{dy}{dx} \right)_1 \left(\frac{dy}{dx} \right)_2 &= \gamma^2 \frac{f_2^2(\zeta)}{f_1^2(\zeta)} \left(\gamma - \frac{d\phi}{dt} \right)_1 \left(\gamma - \frac{d\phi}{dt} \right)_2 = \frac{\gamma^2 f_2(\zeta) f_2'(\zeta)}{f_1(\zeta) f_1'(\zeta)} \\ &= \gamma^2 \frac{d[f_2^2(\zeta)]}{d[f_1^2(\zeta)]} = -1 + \frac{d[f_1^2(\zeta) + \gamma^2 f_2^2(\zeta)]}{d[f_1^2(\zeta)]}. \end{aligned}$$

In case

$$f_1^2(\zeta) + \gamma^2 f_2^2(\zeta) = \text{constant},$$

the product $\left(\frac{dy}{dx} \right)_1 \cdot \left(\frac{dy}{dx} \right)_2 = -1$, *i. e.* the branches are in this case rectangular.

As $\frac{1}{2} f_1^2(\zeta)$ is the value of the energy of the X-vibration, $\frac{1}{2} \gamma^2 f_2^2(\zeta)$ the value of the energy of the Y-vibration, the condition implies the conservation of energy.

We have found now :—

The ends (meant in a dynamical sense) of the double curves of system (19) appear as double points in the envelope. If the energy of the motion is constant, then the branches in the double points are rectangular.

In case of the motion, indicated by (17, § 27), the energy is constant ; so for the different systems of curves we shall

have to consider the branches in the double point are always rectangular. In this case

$$f_1(\zeta) = \sqrt{\zeta}, \quad f_2(\zeta) = \frac{1}{\gamma} \sqrt{1-\zeta}, \quad \psi(\zeta) = \frac{f(\zeta)}{\sqrt{\zeta^\gamma(1-\zeta)}}; \quad (20)$$

passes into

$$\begin{aligned} & \gamma(1-\zeta) \sin(\gamma t - \phi) \sin(t - \phi) - \zeta \sin \gamma t \sin t \\ & = 2\sqrt{\frac{1-\zeta}{\zeta^{\gamma-2}}} f(\zeta) \sin(\gamma t - \phi) \sin t. \quad (22) \end{aligned}$$

§ 32. We now shall investigate whether the envelope possesses points where the tangential line is parallel to the X-axis or to the Y-axis. We suppose $f_1(\zeta)$ and $f_2(\zeta)$, the amplitudes of the vibrations, not to become infinite; however, $f_1'(\zeta)$ and $f_2'(\zeta)$ may become infinite.

From

$$\frac{dy}{dx} = \frac{\gamma f_2(\zeta) \sin(\gamma t - \phi)}{f_1(\zeta) \sin t}$$

it follows that $\frac{dy}{dx} = 0$, when $f_2(\zeta) = 0$, or $\sin(\gamma t - \phi) = 0$, whilst $f_1(\zeta) \neq 0$ and $\sin t \neq 0$. If $f_2(\zeta) = 0$, then in general $f_1'(\zeta)$ or $\psi'(\zeta)$ will not at the same time be infinite, and $f_1(\zeta), f_2'(\zeta)$ or $\sin \phi$ will not in general be zero at the same time. Therefore we may deduce from (20, § 30) that for $f_2(\zeta) = 0 \cos(\gamma t - \phi) = 0$. If $\sin(\gamma t - \phi) = 0$, then either $f_1'(\zeta) = \infty$, or $\psi'(\zeta) = \infty$, or $f_1(\zeta) = 0$, or $f_2'(\zeta) = 0$, or $\sin \phi = 0$ (according to 20). The last condition, if combined with $\sin(\gamma t - \phi) = 0$, gives the summits of the double curves.

For $f_1(\zeta) = 0 \frac{dy}{dx}$ takes the indefinite form; this condition gives in general multiple points. So we may say: the tangential line to the envelope is parallel to the X-axis

- (1) at the summits of the double curves, and
- (2) at the points of the X-axis given by $f_2(\zeta) = 0$, $\cos(\gamma t - \phi) = 0$.

From

$$\frac{dy}{dx} = \frac{\gamma f_2(\zeta) \sin(\gamma t - \phi)}{f_1(\zeta) \sin t}$$

it follows that $\frac{dy}{dx} = \infty$, when $f_1(\zeta) = 0$ or $\sin t = 0$, whilst $f_2(\zeta) \neq 0$ and $\sin(\gamma t - \phi) \neq 0$. If $f_1(\zeta) = 0$, then in general $\cos t = 0$ (according to 20). If $\sin t = 0$, then either $f_2'(\zeta) = \infty$, or $\psi'(\zeta) = \infty$, or $f_2(\zeta) = 0$, or $f_1'(\zeta) = 0$, or $\sin \phi = 0$. The last condition in connexion with $\sin t = 0$

would give the ends of the double curves. For $f_2(\zeta) = 0 \frac{dy}{dx}$ takes the indefinite form; this condition gives in general multiple points.

So we have found: the only points where the tangential line to the envelope is parallel to the Y-axis are given by $f_1(\zeta) = 0, \cos t = 0$.

§ 33. In several simple cases that will be discussed afterwards, we may observe that cusps may appear in the envelope. In order to examine the appearance of these points we must put $\frac{d^2y}{dx^2} = \infty$. We write (21, § 31) in this form :

$$f_1(\zeta) \sin t \frac{dy}{dx} - \gamma f_2(\zeta) \sin(\gamma t - \phi) = 0.$$

Differentiation according to t gives :

$$\begin{aligned} f_1(\zeta) \sin t \frac{d^2y}{dx^2} \cdot \frac{dx}{dt} + f_1'(\zeta) \sin t \frac{d\zeta}{dt} \cdot \frac{dy}{dx} + f_1(\zeta) \cos t \frac{dy}{dx} - \gamma f_2'(\zeta) \frac{d\zeta}{dt} \sin(\gamma t - \phi) \\ - \gamma^2 f_2(\zeta) \cos(\gamma t - \phi) + \gamma f_2(\zeta) \sin(\gamma t - \phi) \frac{d\phi}{dt} = 0. \end{aligned}$$

We have successively to discuss these conditions :

$$\sin t = 0, f_1(\zeta) = 0, \frac{dx}{dt} = 0, \frac{dy}{dx} = \infty, f_1'(\zeta) = \infty, f_2'(\zeta) = \infty, \frac{d\zeta}{dt} = \infty, \frac{d\phi}{dt} = \infty.$$

$\sin t = 0$ gives, as we have found § 32, either $f_2'(\zeta) = \infty$, or $\psi'(\zeta) = \infty$, or $f_2(\zeta) = 0$, or $f_1'(\zeta) = 0$, or $\sin \phi = 0$. For

$\sin t = 0$, combined with $f_2(\zeta) = 0$, $\frac{dy}{dx}$ takes the indefinite form; this gives in general multiple points. $\sin \phi = 0$ with $\sin t = 0$ would give the ends of the double curves. Therefore we have to combine $\sin t = 0$ with one of the conditions $f_2'(\zeta) = \infty$, $\psi_1'(\zeta) = \infty$, or $f_1'(\zeta) = 0$.

In § 32 we have seen that for $f_1(\zeta) = 0 \cos t = 0$ in general.

The condition $\frac{dx}{dt} = 0$ may be written in this form :

$$\frac{d\zeta}{dt} = \frac{f_1(\zeta)}{f_1'(\zeta)} \cdot \tan t.$$

$\frac{dy}{dx} = \infty$ involves either $f_1(\zeta) = 0$ or $\sin t = 0$; these conditions have been discussed already.

For $f_1'(\zeta) = \infty$ we have in general, according to (20), $\cos t = 0$, or $\sin(\gamma t - \phi) = 0$.

For $f_2'(\zeta) = \infty$ we have in general, according to (20), $\sin t = 0$, or $\cos(\gamma t - \phi) = 0$.

In order to examine the conditions $\frac{d\zeta}{dt} = \infty$ and $\frac{d\phi}{dt} = \infty$ we write (20) in the form

$$f(\phi, \zeta, t) = 0.$$

From this equation and (19) it follows :

$$\sin \phi \cdot \frac{d\phi}{dt} + \psi'(\zeta) \cdot \frac{d\zeta}{dt} = 0,$$

$$\frac{df}{d\phi} \cdot \frac{d\phi}{dt} + \frac{\partial f}{\partial \zeta} \cdot \frac{d\zeta}{dt} + \frac{\partial f}{\partial t} = 0.$$

In general the two conditions $\frac{d\zeta}{dt} = \infty$ and $\frac{d\phi}{dt} = \infty$ coincide ; they are satisfied when

$$\frac{\partial f}{\partial \zeta} \cdot \sin \phi - \frac{\partial f}{\partial \phi} \cdot \psi'(\zeta) = 0.$$

$$\underline{2n_x - n_y = \rho.}$$

§ 34. The osculating curves are given by

$$\left. \begin{aligned} x &= \sqrt{\zeta} \cos t, \\ y &= \frac{1}{2} \sqrt{1-\zeta} \cos(2t-\phi), \end{aligned} \right\} \dots \dots (23)$$

whilst

$$\zeta \sqrt{1-\zeta} \cos \phi = k + \rho' \zeta. \dots \dots (24)$$

The vertices of the circumscribed rectangles lie in the circumference of the ellipse $x^2 + 4y^2 = 1$.

The Lissajous double curves are parabolæ ; for $\phi = 0$ the parabola has its opening turned upwards, for $\phi = \pi$ turned downwards.

The Lissajous curve corresponding to $\cos \phi = 0$ has a double point in O.

The curves corresponding to an arbitrary value of ϕ have a node in the Y-axis at a distance $-\frac{1}{2} \sqrt{1-\zeta} \cos \phi$ from the X-axis.

In the case of libration the curves of the system have their nodes all at the same side of O ; the double curves have their opening to the same side. In the case of the general form of motion the nodes of the curves lie partly on one, partly on the other side of O ; the double curves have their openings to different sides. In the case of the periodic form of motion the same parabola is continually described. In the asymptotic case the motion approaches to a Y-vibration.

§ 35. *Envelope.* For this case (22, § 31) takes the form :

$$\begin{aligned} 2(1-\zeta) \sin (2t-\phi) \sin (t-\phi)-\zeta \sin 2t \sin t \\ =2\rho' \sqrt{1-\zeta} \sin (2t-\phi) \sin t. \end{aligned}$$

When multiplying with $\sin \phi$ we get :

$$\begin{aligned} (1-\zeta) \sin (t-\phi)\left\{\sin ^2 t-\sin ^2(t-\phi)\right\}-\zeta \sin ^2 t \cos t \sin \phi \\ =\rho' \sqrt{1-\zeta} \sin t\left\{\sin ^2 t-\sin ^2(t-\phi)\right\}. \end{aligned}$$

When multiplying with $\frac{\sqrt{1-\zeta}}{\sin ^3 t}$ and making use of (24) we get :

$$\begin{aligned} -\left(\frac{\sqrt{1-\zeta} \sin (t-\phi)}{\sin t}\right)^3+\left(\frac{\sqrt{1-\zeta} \sin (t-\phi)}{\sin t}\right) \\ =k+\rho'-\rho'\left(\frac{\sqrt{1-\zeta} \sin (t-\phi)}{\sin t}\right)^2. \end{aligned}$$

Putting $\frac{\sqrt{1-\zeta} \sin (t-\phi)}{\sin t}=\frac{k+\rho'v}{v},$

then we get :

$$v^2(1-v)-(k+\rho'v)^2=0.$$

Now this cubic equation has the same coefficients as the equation which serves to determine the values of ζ corresponding to $\sin \phi=0$. The equation has two positive roots which we shall call ζ_1 and ζ_2 (we suppose $\zeta_2>\zeta_1$) and one negative root $-\lambda$.

So the relation between ζ and t degenerates into :

$$\begin{aligned} \frac{\sqrt{1-\zeta} \sin (t-\phi)}{\sin t}=\frac{k+\rho'\zeta_1}{\zeta_1}, \quad \frac{\sqrt{1-\zeta} \sin (t-\phi)}{\sin t}=\frac{k+\rho'\zeta_2}{\zeta_2}, \\ \frac{\sqrt{1-\zeta} \sin (t-\phi)}{\sin t}=\frac{k-\rho'\lambda}{-\lambda}. \end{aligned}$$

Now we reduce the first member of these equations as follows :—

$$\begin{aligned} \frac{\sqrt{1-\zeta} \sin (t-\phi)}{\sin t} &= \frac{\sqrt{1-\zeta} \sin (2t-\phi) \cos t-\sqrt{1-\zeta} \cos (2t-\phi) \sin t}{\sin t} \\ &= \frac{\sqrt{1-\zeta} \sin (2t-\phi)}{\sqrt{\zeta} \sin t} \cdot \sqrt{\zeta} \cos t-\sqrt{1-\zeta} \cos (2t-\phi)=\frac{dy}{dx} x-2y. \end{aligned}$$

So the first equation becomes :

$$x \frac{dy}{dx} - 2y = \frac{k + \rho' \zeta_1}{\zeta_1}.$$

Or, after integration :

$$y = Cx^2 - \frac{1}{2} \frac{k + \rho' \zeta_1}{\zeta_1}.$$

The envelope has degenerated into three parabolæ, having the same axis ; according to § 31 (p. 296) they intersect (in the ends of the double curves) under right angles, so they are confocal.

In order to determine the value of the constants C we have but to recollect that one of the parabolæ passes through the points $(\sqrt{\zeta_1}, \frac{1}{2} \sqrt{1-\zeta_1})$ and $(\sqrt{\zeta_2}, \frac{1}{2} \sqrt{1-\zeta_2})$. Let it be the parabola

$$y = Cx^2 - C_1.$$

Then we have :

$$\frac{1}{2} \sqrt{1-\zeta_1} = C\zeta_1 - C_1,$$

$$\frac{1}{2} \sqrt{1-\zeta_2} = C\zeta_2 - C_1.$$

Therefore

$$C = \frac{\sqrt{1-\zeta_1} - \sqrt{1-\zeta_2}}{2(\zeta_1 - \zeta_2)}.$$

The equation from which ζ_1 and ζ_2 have been found runs

$$\zeta^2(1-\zeta) - (k + \rho'\zeta)^2 = 0. \dots \dots (25)$$

From this we may deduce :

$$\sqrt{1-\zeta_1} = \frac{k}{\zeta_1} + \rho', \quad \sqrt{1-\zeta_2} = \frac{k}{\zeta_2} + \rho'.$$

Then we get :

$$C = \frac{\frac{k}{\zeta_1} - \frac{k}{\zeta_2}}{2(\zeta_1 - \zeta_2)} = -\frac{1}{2} \frac{k}{\zeta_1 \zeta_2} = -\frac{1}{2} \frac{k\lambda}{\zeta_1 \zeta_2 \lambda}.$$

The product of the roots of the cubic equation being $-k^2$,

$$C = -\frac{\lambda}{2k}.$$

Now we must decide, whether

$$C_1 = \frac{k + \rho' \zeta_1}{\zeta_1}, \quad \frac{k + \rho' \zeta_2}{\zeta_2}, \quad \text{or} \quad \frac{k - \rho' \lambda}{-\lambda}.$$

The parabola we have in view has its top on the outside of the ellipse that contains the vertices of the circumscribed rectangles. Now according to (25) :

$$\frac{k + \rho' \zeta_1}{\zeta_1} = \sqrt{1 - \zeta_1}, \quad \frac{k + \rho' \zeta_2}{\zeta_2} = \sqrt{1 - \zeta_2}, \quad \frac{k - \rho' \lambda}{-\lambda} = \sqrt{1 + \lambda}.$$

Only the last of these expressions surpasses unity. So one of the enveloping parabolæ has the equation :

$$2y - \frac{-\lambda}{k} x^2 + \frac{k}{-\lambda} + \rho' = 0.$$

The focus of this parabola is at a distance of $-\frac{1}{2}\rho'$ from the X-axis ; this focus is at the same time the focus of the remaining enveloping parabolæ. Therefore the equations become :

$$\left. \begin{aligned} 2y - \frac{\zeta_1}{k} x^2 + \frac{k}{\zeta_1} + \rho' &= 0 & \zeta_1 \text{ parabola.} \\ 2y - \frac{\zeta_2}{k} x^2 + \frac{k}{\zeta_2} + \rho' &= 0 & \zeta_2 \text{ ,,} \\ 2y - \frac{-\lambda}{k} x^2 + \frac{k}{-\lambda} + \rho' &= 0 & \lambda \text{ ,,} \end{aligned} \right\} \dots (26')$$

We must notice that the calculation is exact only in case $\phi = 0$ for $\zeta = \zeta_1$ and $\zeta = \zeta_2$; if $\phi = \pi$ for one of these values of ζ or for both, then the calculation is not exact ; however, it is not difficult to verify that the system of equations we arrive at is always the same.

§ 36. *Strict relation.*—In case the strict relation $n_y - 2n_x = 0$ is satisfied we have $\rho' = 0$; the relation between ζ and ϕ runs :

$$\zeta \sqrt{1 - \zeta} \cos \phi = k.$$

The enveloping parabolæ have their focus at O.

Fig. 15 gives a representation ; besides the enveloping parabolæ some osculating curves, among which the double curves, have been drawn ; the figure corresponds to a positive value of k . The enveloping parabola, which has its opening turned downwards, is the λ parabola ; of the two remaining parabolæ, the ζ_2 parabola has its top nearest to the X-axis (ζ_2 being $> \zeta_1$).

The periodic form of motion we have for the maximal value of $k^2(\frac{4}{27})$. Then $\zeta_1 = \zeta_2 = \frac{2}{3}$, $\sin \phi = 0$ invariably. The motion takes place in a parabola, in which the ζ_1 and ζ_2

enveloping parabolæ have coincided (fig. 14). The X- and Y-amplitudes being resp. $\sqrt{\frac{2}{3}}$ and $\frac{1}{2}\sqrt{\frac{1}{3}}$, they have a ratio of $2\sqrt{2}:1$. This result was also found in another way by Lord Rayleigh*.

The asymptotic form of motion we have for $k=0$. The relation between ζ and ϕ degenerates into $\zeta=0$, $\zeta=1$, $\cos\phi=0$. In case of the asymptotic form of motion $\cos\phi=0$ invariably; the motion approaches asymptotically to a motion in the YZ-plane (fig. 16). The ζ_2 enveloping parabola has degenerated into the Y-axis.

§ 37. *Approximate relation.*—The focus of the enveloping parabolæ is at a distance of $-\frac{1}{2}\rho'$ from O. According to § 22 we may for a certain value of $\rho' < 1$ distinguish the following forms of motion:—

$k > 0$. All is in main points the same as in the case $\rho'=0$.

k has its maximal value. The periodic form of motion corresponding to this value of k differs from the periodic form of motion we had for $\rho'=0$ only by the value of ζ .

$k=0$. The $\zeta-\phi$ relation degenerates into $\zeta=0$ and $\sqrt{1-\zeta}\cos\phi=\rho'$. Now according to § 34 (p. 300)

$$-\frac{1}{2}\sqrt{1-\zeta}\cos\phi$$

is the distance of the node of an osculating curve from the X-axis. Therefore in the asymptotic case all osculating curves have their nodes at the same point of the Y-axis, at a distance of $-\frac{1}{2}\sqrt{1-\zeta}\cos\phi=-\frac{1}{2}\rho'$ from the X-axis; i. o. w. the nodes are at B. The ζ_2 enveloping parabola has degenerated into the Y-axis. For $k=0$ the ζ_1 and λ parabolæ exchange their place; for a positive value of k the λ parabola has its opening turned downwards, the ζ_1 parabola upwards; for a negative value of k the tables are turned (fig. 17).

$-\rho' < k < 0$. The nodes of the osculating curves lie on both sides of O (fig. 18).

$k = -\rho'$. One of the Lissajous double curves has degenerated into the X-axis; the ζ_2 enveloping parabola passes through O; the nodes of the osculating curves lie above O.

$k < -\rho'$. We may get the system of curves and their envelope by turning the system we have for $k > 0$ over 180° .

k has its minimal value. Periodic form of motion; $\phi = \pi$ invariably.

For $\rho' > 1$ the focus of the enveloping parabolæ lies outside the ellipse $x^2 + 4y^2 = 1$. According to § 22 we have

* Phil. Mag. [6] vol. xx. (1910).

now only to consider $k < 0$; so only the four last forms of motion are possible. For increasing values of ρ' the general form of motion ($-\rho' < k < 0$) becomes preponderant more and more; the focus of the enveloping parabolæ moves farther; fig. 19 shows how the limitation approaches more and more to the rectangle of the general case where no relation exists.

$$\underline{3n_x - n_y = \rho.}$$

§ 38. The osculating curves are given by :

$$\left. \begin{aligned} x &= \sqrt{\zeta} \cos t, \\ y &= \frac{1}{3} \sqrt{1-\zeta} \cos (3t-\phi), \end{aligned} \right\} \dots \dots (27)$$

whilst

$$\zeta \sqrt{\zeta(1-\zeta)} \cos \phi = p\zeta^2 + q\zeta + r.$$

The vertices of the circumscribed rectangles lie in the circumference of the ellipse :

$$x^2 + 9y^2 = 1.$$

The Lissajous curve corresponding to an arbitrary value of ϕ has two nodes. For $\cos \phi = 0$ the nodes lie in the X-axis on either side of O at distances $\frac{\sqrt{\zeta}}{2}$ from O; for an arbitrary value of ϕ the distance of the nodes from the Y-axis is also $\frac{\sqrt{\zeta}}{2}$, the distance from the X-axis is $\frac{1}{3} \sqrt{1-\zeta} \cos \phi$. One of the nodes is reached at the moments $t = \frac{\pi}{3}$ and $t = \frac{5\pi}{3}$, the other at the moments $t = \frac{2\pi}{3}$ and $t = \frac{4\pi}{3}$.

The Lissajous double curves pass through O.

In the case of the libration as well as in the case of the general form of motion in the extreme rectangles, double curves are described. In the former case the ends of the double curves lie two by two in opposite quadrants; in the latter case in each of the four quadrants one end lies.

§ 39. *Enveloping curves.*—We shall restrict ourselves to the case that $p=0$ and $q=0$ in the relation between ζ and ϕ . Then

$$\zeta \sqrt{\zeta(1-\zeta)} \cos \phi = r. \dots \dots (28)$$

We suppose r to be positive.

For an arbitrary value of r we have the case of libration, $\cos \phi$ remaining positive. The maximal value ($\frac{3}{16}\sqrt{3}$) and the minimal value of $r(0)$ give rise to the special cases resp. of the periodic and of the asymptotic form of motion.

In the case of the periodic form of motion $\zeta = \frac{3}{4}$ and $\sin \phi = 0$; the same double curve is continually described, which is in the same time the envelope (fig. 20).

In the case of the asymptotic form of motion we have $\phi = \frac{\pi}{2}$. For this case (22) of p. 298 passes into :

$$3(1-\zeta) \cos 3t \cos t - \zeta \sin 3t \sin t = 0. \quad . \quad . \quad (29)$$

Therefore

$$\zeta = \frac{3 \cos 3t \cos t}{3 \cos 3t \cos t + \sin 3t \sin t}.$$

By substitution of this in the expressions for x and y , we find

$$x = \sqrt{\frac{3 \cos 3t \cos^3 t}{3 \cos 3t \cos t + \sin 3t \sin t}}; \quad y = \frac{1}{3} \sqrt{\frac{\sin t \sin^3 3t}{3 \cos 3t \cos t + \sin 3t \sin t}}.$$

Furthermore we have :

$$\frac{dy}{dx} = - \frac{\sqrt{1-\zeta} \cos 3t}{\sqrt{\zeta} \sin t} = - \sqrt{\frac{\sin 3t \sin t \cos^2 3t}{3 \cos 3t \cos t \sin^2 t}} = - \sqrt{\frac{\sin 6t}{3 \sin 2t}}.$$

From this it is possible to deduce the shape of the envelope. $x=0$ for $\cos 3t=0$ and for $\cos t=0$. For $\cos 3t=0$,

$y = \pm \frac{1}{3}$, $\frac{dy}{dx} = 0$; for $\cos t=0$, $y = \pm \frac{1}{3}$, $\frac{dy}{dx} = \pm 1$. $y=0$ for $\sin 3t=0$ and for $\sin t=0$. For $\sin 3t=0$, $x = \pm \frac{1}{2}$, $\frac{dy}{dx} = 0$; for $\sin t=0$, $x = \pm 1$, $\frac{dy}{dx} = \pm 1$. The enveloping curve is,

besides some osculating curves, represented in fig. 22.

Now we may put the question, what is the signification of the different parts of the envelope. A definite Lissajous curve is enveloped in different points, in other words to a definite value of ζ correspond different values of t for the envelope. Let t_1 and t_2 be two of these values, then from (29) it follows

$$\frac{\sin 3t_1 \sin t_1}{\cos 3t_1 \cos t_1} = \frac{\sin 3t_2 \sin t_2}{\cos 3t_2 \cos t_2}.$$

After reduction this relation degenerates into

$$\cos 2t_1 = \cos 2t_2 \quad \text{and} \quad \cos 2t_1 \cos 2t_2 = -\frac{1}{2}.$$

The former equation expresses only that O is centre of the

envelope. From the latter one it follows that either $\cos 2t_1$ or $\cos 2t_2$ is positive. Let $\cos 2t_1$ be positive, then $\cos 2t_1$ lies between $\frac{1}{2}$ and 1, $\cos 2t_2$ between $-\frac{1}{2}$ and -1 .

A Lissajous curve corresponding to $\cos \phi = 0$ consists of three parts, which are separated by the two double points. For the middle part x lies between $\frac{1}{2}\sqrt{\zeta}$ and $-\frac{1}{2}\sqrt{\zeta}$; therefore $\cos t$ lies for this part between $\frac{1}{2}$ and $-\frac{1}{2}$, and $\cos 2t$ between -1 and $-\frac{1}{2}$. For the other parts $\cos 2t$ lies between 0 and -1 or $-\frac{1}{2}$ and $+1$.

Therefore the envelope consists of a part that envelopes the middle part of the Lissajous figures and a part that envelopes the other parts.

§ 40. For an arbitrary value of r the maximal value of ϕ belongs to $\zeta = \frac{3}{4}$, because ϕ is max., when $\cos \phi$ is min., but from $\zeta\sqrt{\zeta(1-\zeta)} \cos \phi = r$ it follows that $\cos \phi$ is min., when $\zeta^3(1-\zeta)$ is max., and this takes place for $\zeta = \frac{3}{4}$.

The locus of the double points of the system of curves may be determined in this way. For a definite Lissajous curve the coordinates of the double points are :

$$x = \pm \frac{1}{2}\sqrt{\zeta}, \quad y = \mp \frac{1}{3}\sqrt{1-\zeta} \cos \phi.$$

By eliminating ζ and ϕ between these two equations and the relation $\zeta\sqrt{\zeta(1-\zeta)} \cos \phi = r$ we get :

$$x^3y = -\frac{1}{24}r.$$

On this curve lie also the summits of the double curves.

When for an arbitrary value of r we wish to determine the shape of the envelope, we have to consider that this envelope has no points where the tangential line is parallel to the Y-axis, and that the only points where the tangential line is parallel to the X-axis are the summits of the double curves (conf. § 32; here $f_1(\zeta) = \sqrt{\zeta}$, $f_2(\zeta) = \frac{1}{3}\sqrt{1-\zeta}$; ζ does not become 0 or 1).

Besides the ends of the double curves (with the direction of the tangential lines) and the summits of the double curves, some other points of the envelope may easily be found. We therefore must consider the Lissajous curve, for which $\zeta = \frac{3}{4}$.

(22) of p. 298 takes this form :

$$3(1-\zeta) \sin (3t-\phi) \sin (t-\phi) - \zeta \sin 3t \sin t = 0. \quad (30)$$

For $\zeta = \frac{3}{4}$ we get

$$\sin (3t-\phi) \sin (t-\phi) - \sin 3t \sin t = 0.$$

After reduction :

$$t = \frac{1}{4}\phi + n \times 45^\circ.$$

The eight points in which the curve we have in view is enveloped are

$$x = \frac{1}{2}\sqrt{3} \cos(\frac{1}{4}\phi + n \times 45^\circ),$$

$$y = \frac{1}{6} \cos(-\frac{1}{4}\phi + 3n \times 45^\circ) = \pm \frac{1}{6} \cos(\frac{1}{4}\phi + n \times 45^\circ).$$

Therefore
$$\frac{x}{y} = \pm 3\sqrt{3}.$$

These points are situated on the diagonals of the rectangle in which the curve is described.

Furthermore,

$$\frac{dy}{dx} = \frac{\sqrt{1-\zeta} \sin(3t-\phi)}{\sqrt{\zeta} \sin t} = \pm \frac{1}{3}\sqrt{3}.$$

The tangential lines in these points form with the X-axis angles of 30° or 150° .

In the envelope cusps appear. In order to determine the situation of these cusps, we would have to calculate ζ , ϕ , and t from three equations, namely (28) of § 39, (30) of this section, and the third equation is (§ 33) either $\frac{d\zeta}{dt} = \infty$ or $\frac{dx}{dt} = 0$. However, these systems become rather intricate.

In fig. 21 the envelope with some of the Lissajous curves is represented.

$$\underline{n_x - n_y = \rho.}$$

§ 41. The Lissajous curves for this case, given by

$$\left. \begin{aligned} x &= \sqrt{\zeta} \cos t, \\ y &= \sqrt{1-\zeta} \cos(t-\phi), \end{aligned} \right\} \dots (31)$$

are ellipses. The double curves are straight lines passing through O. The ellipses corresponding to $\cos \phi = 0$ have their axes along the axes of coordinates. For an arbitrary value of ϕ the ellipse has an arbitrary shape and position.

In order to investigate the change in shape and position of the ellipse, we may write down the well-known relations which may serve for the calculation of the axes of the ellipse and the angle of inclination of the long axis with the X-axis. If A and B are half the larger and half the smaller

axis, and if θ is the angle we have in view, then these relations become

$$\left. \begin{aligned} \frac{1}{A^2} + \frac{1}{B^2} &= \frac{1}{\zeta(1-\zeta) \sin^2 \phi}, \\ \frac{1}{A^2 B^2} &= \frac{1}{\zeta(1-\zeta) \sin^2 \phi}, \\ \tan 2\theta &= \frac{2\sqrt{\zeta(1-\zeta)}}{1-2\zeta} \cos \phi. \end{aligned} \right\} \dots (32)$$

From the first and the second of these relations we deduce $A^2 + B^2 = 1$. The vertices of an arbitrary rectangle circumscribed to any one of the ellipses lie on the circumference of a circle with unity as radius.

In a system of ellipses there are two double curves, or there are no double curves.

§ 42. *Envelope.* (22) of p. 298 becomes for this case

$$(1-\zeta) \sin^2(t-\phi) - \zeta \sin^2 t = 2\sqrt{\zeta(1-\zeta)} f'(\zeta) \sin(t-\phi) \sin t. \quad (33)$$

We may write it in this form :

$$\frac{(1-\zeta) \sin^2(t-\phi)}{\zeta \sin^2 t} - 2f'(\zeta) \frac{\sqrt{1-\zeta} \sin(t-\phi)}{\sqrt{\zeta} \sin t} - 1 = 0.$$

According to (21, § 31) we have

$$\frac{dy}{dx} = \frac{\sqrt{1-\zeta} \sin(t-\phi)}{\sqrt{\zeta} \sin t}.$$

Therefore

$$\left(\frac{dy}{dx}\right)^2 - 2f'(\zeta) \frac{dy}{dx} - 1 = 0. \quad \dots (34)$$

This quadratic equation in $\frac{dy}{dx}$ gives the direction of the envelope in those points in which it envelopes a same ellipse, defined by the value of ζ . To each value of $\frac{dy}{dx}$ two points of the ellipse belong. The product of the roots of the equation being -1 , we can say that the tangential lines to the ellipse in the points in which it is enveloped form a rectangle.

§ 43. We have found already (§ 20) that in the case $\gamma = 1$ $\frac{d\zeta}{dt}$ may become zero not only for $\sin \phi = 0$, but also for $\cos \phi = -\frac{l}{2\sqrt{\zeta(1-\zeta)}}$.

There are three different cases :—

(1) In one of the extreme rectangles $\sin \phi = 0$; in the other $\cos \phi = -\frac{l}{2\sqrt{\xi(1-\xi)}}$. The ends of the double curve are double points of the envelope. The envelope consists of two segments.

(2) In both extreme rectangles $\sin \phi = 0$. The ends of the double curves are double points of the envelope. The envelope consists of four segments.

(3) In both extreme rectangles $\cos \phi = -\frac{l}{2\sqrt{\xi(1-\xi)}}$.

In the system there exist no double curves; in the envelope no double points appear. The envelope consists of two closed curves, not intersecting each other. One of these curves is the outward envelope, the other the inward envelope.

§ 44. From the form of $f(\xi)$ for the case $\gamma = 1$, given on p. 294, we deduce

$$f^{1/2}(\xi) + 1 = \frac{4p(p+1)\xi^2 + 4q(p+1)\xi + q^2 + 4r + l^2}{4(p\xi^2 + q\xi + r + \frac{1}{4}l^2)}.$$

Now from the relation (34),

$$\frac{dy}{dx} = f'(\xi) \pm \sqrt{f^{1/2}(\xi) + 1},$$

we come to the supposition that simple cases will occur when

$$4p(p+1)\xi^2 + 4q(p+1)\xi + q^2 + 4r + l^2$$

is a complete square. The condition runs:

$$4p(p+1)(q^2 + 4r + l^2) = q^2(p+1)^2,$$

which condition degenerates into

$$p+1=0$$

and

$$p(q^2 + 4r + l^2) = q^2(p+1),$$

which may be written in this form:

$$p(4r + l^2) = q^2;$$

this expresses at the same time the condition that the denominator of the fraction, written down at the beginning of this section, is a complete square. In this latter case $f(\xi)$ is a linear function of ξ . Therefore we pass to the discussion of these two cases:

$$p = -1.$$

$f(\xi)$ is a linear function of ξ .

§ 45. Case $p = -1$.

The motion in an arbitrary ellipse can be analysed in two rectangular oscillations. Taking a new system of axes of coordinates, the expressions for x and y hold the same form. But the values of ζ and ϕ for a certain ellipse will be altered in general. Considering the whole system of ellipses, we can say that the relation between ζ and ϕ will also be altered. The new values of ζ and ϕ we respectively call ζ' and ϕ' .

We shall prove now that in the case supposed ($p = -1$) it is always possible to turn the system of axes through an angle ψ so that the relation between ζ' and ϕ' takes this form :

$$\sqrt{\zeta'(1-\zeta')} \cos \phi' = \pm \sqrt{-\zeta'^2 + q\zeta' + r'}.$$

Or, what is the same :

$$\sqrt{\zeta'(1-\zeta')} \sin \phi' = \pm \sqrt{m\zeta' + n}.$$

The new coordinates are given by

$$x' = x \cos \psi - y \sin \psi, \quad y' = x \sin \psi + y \cos \psi.$$

Therefore

$$x' = \sqrt{\zeta} \cos \psi \cos t - \sqrt{1-\zeta} \sin \psi \cos (t-\phi).$$

This may be expressed in a single trigonometrical term. Then

$$\zeta' = \zeta \cos^2 \psi + (1-\zeta) \sin^2 \psi - 2\sqrt{\zeta(1-\zeta)} \cos \phi \sin \psi \cos \psi.$$

From (32, § 41) it follows that $\zeta(1-\zeta) \sin^2 \phi$ is an invariant. Therefore

$$\zeta'(1-\zeta') \sin^2 \phi' = \zeta(1-\zeta) \sin^2 \phi.$$

If the relation between ζ' and ϕ' will take the form

$$\zeta'(1-\zeta') \sin^2 \phi' = m\zeta' + n,$$

then it must be possible to write the relation between ζ and ϕ as follows :

$$\zeta(1-\zeta) \sin^2 \phi = m\{\zeta \cos^2 \psi + (1-\zeta) \sin^2 \psi - 2\sqrt{\zeta(1-\zeta)} \cos \phi \sin \psi \cos \psi\} + n.$$

After reduction,

$$\zeta(1-\zeta) \cos^2 \phi - m \sin 2\psi \sqrt{\zeta(1-\zeta)} \cos \phi + \zeta^2 + (m \cos 2\psi - 1)\zeta + m \sin^2 \psi + n = 0.$$

Now for $p = -1$ the relation between ζ and ϕ runs

$$\zeta(1-\zeta) \cos^2 \phi + l \sqrt{\zeta(1-\zeta)} \cos \phi - (-\zeta^2 + q\zeta + r) = 0.$$

We therefore shall have to determine m , n , and ψ from the system

$$\begin{cases} -m \sin 2\psi = l, \\ 1 - m \cos 2\psi = q, \\ -n - m \sin^2 \psi = r. \end{cases}$$

From the first two equations we deduce :

$$\begin{aligned} \tan 2\psi &= \frac{l}{q-1}, \\ m^2 &= l^2 + (q-1)^2. \end{aligned}$$

n is to be found from

$$n = -r - m \sin^2 \psi.$$

So it is always possible to find values of ψ , m , and n ; the relation between ζ' and ϕ' may therefore be written in this form

$$\zeta'(1-\zeta') \sin^2 \phi' = m\zeta' + n.$$

There are two values of ψ , m , and n ; so there are two different systems of ellipses, each of them having its own envelope.

§ 46. We suppose the turn of the axes to have taken place. Therefore we have to take the relation between ζ and ϕ in this form :

$$\zeta(1-\zeta) \sin^2 \phi = m\zeta + n. \quad \dots \quad (35)$$

The equation of the envelope runs :

$$(1-\zeta) \sin^2 (t-\phi) - \zeta \sin^2 t = 2 \sqrt{\zeta(1-\zeta)} f'(\zeta) \sin t \sin (t-\phi),$$

where

$$\begin{aligned} f(\zeta) &= \sqrt{\zeta(1-\zeta) - (m\zeta + n)}, \\ f'(\zeta) &= \frac{1-2\zeta-m}{2\sqrt{\zeta(1-\zeta) - (m\zeta + n)}} = \frac{1-2\zeta-m}{2\sqrt{\zeta(1-\zeta)} \cos \phi}. \end{aligned}$$

Therefore

$$(1-\zeta) \sin^2 (t-\phi) \cos \phi - \zeta \sin^2 t \cos \phi = (1-2\zeta-m) \sin t \sin (t-\phi). \quad (36)$$

After reduction :

$$\begin{aligned} (1-\zeta) \sin (t-\phi) \cos (t-\phi) + \zeta \cos t \sin t &= \frac{m\zeta(1-\zeta)}{m\zeta+n} \sin (t-\phi) \sin t \sin \phi, \\ m\zeta(1-\zeta) \sin (t-\phi) \cos^2 t \cos (t-\phi) + n(1-\zeta) \sin (t-\phi) \cos (t-\phi) \\ + m\zeta^2 \cos t \sin t + n\zeta \cos t \sin t + m\zeta(1-\zeta) \sin^2 (t-\phi) \sin t \cos t &= 0. \end{aligned}$$

Dividing by $\sqrt{\zeta} \sin t$, and making use of

$$x = \sqrt{\zeta} \cos t, \quad y = \sqrt{1-\zeta} \cos(t-\phi), \quad \frac{dy}{dx} = \frac{\sqrt{1-\zeta} \sin(t-\phi)}{\sqrt{\zeta} \sin t},$$

we get
$$x^2 y \frac{dy}{dx} + x - xy^2 + \frac{n}{m} y \frac{dy}{dx} + \frac{n}{m} x = 0.$$

The integral of this differential equation runs

$$x^2 + y^2 - 1 = C \left(x^2 + \frac{n}{m} \right), \quad (37)$$

where C is a constant of integration.

The envelope is degenerated into central conic sections, having their axes along the axes of coordinates.

§ 47. In order to determine the value of C we make use of the fact that the envelope contains the points of intersection of an ellipse corresponding to $\cos \phi = 0$ with the axes of coordinates ((36) of § 46 is satisfied by $\cos \phi = 0, \sin t = 0$ or ± 1). The intersecting points of such an ellipse with the Y-axis are given by

$$x = 0, \quad y = \pm \sqrt{1-\zeta}.$$

$\cos \phi = 0$ for the values of ζ satisfying the equation

$$\zeta(1-\zeta) - (m\zeta + n) = 0.$$

From these three equations and the equation of the envelope

$$x^2 + y^2 - 1 = C \left(x^2 + \frac{n}{m} \right)$$

we must eliminate x, y , and ζ .

The result is :

$$C^2 + \frac{m}{n}(1-m)C + \frac{m^2}{n} = 0. \quad . . . (38)$$

This equation being of the second degree, we may say that the envelope is degenerated into two conic sections.

Now there are two cases :—

(1) The system of ellipses contains double curves. This will occur when $\sin \phi$ is zero for values of ζ between 0 and 1. Therefore $m\zeta + n$ must be zero for a value of ζ between 0 and 1. In this case there are two double curves, for the system of ellipses is symmetrical in respect to the axes of coordinates. In the ends of these double curves the enveloping conic sections intersect under right angles. When we examine the values of C it will be clear that one of the conic sections is an ellipse, the other an hyperbola.

(2) The system of ellipses does not contain double curves. The enveloping conic sections are ellipses, one of them being the outward envelope, the other the inward envelope.

When the two values of C are equal, then the two enveloping ellipses coincide; we are in the case of the periodic motion in an ellipse.

§ 48. $f(\zeta)$ is a linear function of ζ . According to § 44 this occurs when

$$p(4r + l^2) = q^2.$$

In this case

$$p\zeta^2 + q\zeta + \frac{1}{4}l^2 = p\left(\zeta + \frac{q}{2p}\right)^2.$$

The relation between ζ and ϕ degenerates into

$$\sqrt{\zeta(1-\zeta)} \cos \phi = \sqrt{p} \zeta + \left(\frac{q}{2\sqrt{p}} - \frac{1}{2}l\right)$$

and
$$\sqrt{\zeta(1-\zeta)} \cos \phi = -\sqrt{p} \zeta - \left(\frac{q}{2\sqrt{p}} + \frac{1}{2}l\right).$$

These relations are of the form

$$\sqrt{\zeta(1-\zeta)} \cos \phi = m\zeta + n.$$

We have now

$$f'(\zeta) = m.$$

According to (34) of p. 309 for this case $\frac{dy}{dx} = \text{const.}$

Therefore: The envelope is degenerated into four straight lines, which are the sides of a rectangle.

The direction of these sides may be found by means of (34). This equation may be written as follows:

$$\frac{2 \frac{dy}{dx}}{1 - \left(\frac{dy}{dx}\right)^2} = -\frac{1}{m}.$$

If $\frac{dy}{dx} = \tan \omega$, then

$$\cot 2\omega = m. \quad \dots \dots \dots (39)$$

The motion of the point takes place exactly as in the general case where no relation exists.

§ 49. $l=0$ and $p=-q$. If we suppose n_y to be nearly equal to n_x , then the lowest point of the surface over which the point moves is supposed to be nearly an ombilic. Now we will make, moreover, the supposition that the surface has

two rectangular planes of symmetry; if these planes are chosen as XZ - and YZ -plane, then $l=0$. In case the planes halving the angles between the planes of symmetry just mentioned are also planes of symmetry, $p=-q$. The relation between ζ and ϕ takes this form:

$$\zeta(1-\zeta) \cos^2 \phi = q\zeta(1-\zeta) + r.$$

When we turn the axes of coordinates through an angle of 45° , then the relation between ζ' and ϕ' must have the same form, but q' and r' will not have in general the values of q and r .

The relation between ζ and ϕ may be written as follows:

$$\zeta(1-\zeta) \sin^2 \phi = (1-q)\zeta(1-\zeta) - r.$$

According to § 41, $\zeta(1-\zeta) \sin^2 \phi$ is an invariant. Therefore according to § 46, ψ being 45° now, we have

$$\zeta'(1-\zeta') \sin^2 \phi' = (1-q)\left\{\frac{1}{4} - \zeta'(1-\zeta') \cos^2 \phi'\right\} - r.$$

After reduction:

$$\zeta'(1-\zeta') \cos^2 \phi' = \frac{1}{q}\zeta'(1-\zeta') + \frac{q-1+4r}{4q}.$$

This may be written:

$$\zeta'(1-\zeta') \cos^2 \phi' = q'\zeta'(1-\zeta') + r',$$

where

$$q' = \frac{1}{q}, \quad r' = \frac{q-1+4r}{4q}. \quad \dots \dots \dots (40)$$

§ 50. The case that $f(\zeta)$ is a linear function of ζ (§ 48) occurs for $l=0$ and $p=-q$ when

$$-4rq = q^2.$$

There are three possibilities, namely, $q=0$, $q=\infty$, and $q=-4r$.

(1) $q=0$. The sides of the enveloping rectangles form, according to § 48, where $m=0$, angles of 45° with the axes of coordinates. For $r=\frac{1}{4}$ $\zeta=\frac{1}{2}$, $\sin \phi=0$ continually; the rectangles have contracted into straight lines (periodic form of motion). For $r=0$ $\cos \phi=0$ continually; the two enveloping rectangles have coincided to a square.

(2) $q=\infty$. This case may be deduced from the foregoing case by turning the axes through an angle of 45° ($q' \neq 0$).

(3) $q=-4r$. We turn the axes of coordinates through such an angle that the sides of an enveloping rectangle are parallel

to the axes of coordinates. This angle must be found from $\cot 2\omega = 2\sqrt{r} (\S 48)$. According to § 46 we have

$$\begin{aligned}\zeta' &= \zeta \cos^2 \omega + (1-\zeta) \sin^2 \omega - 2\sqrt{\zeta(1-\zeta)} \cos \phi \sin \omega \cos \omega \\ &= \zeta \cos^2 \omega + (1-\zeta) \sin^2 \omega - (\zeta - \frac{1}{2}) \sin 2\omega \cot 2\omega \\ &= \frac{1}{2}.\end{aligned}$$

The envelope consists of two squares. In each of these squares we have a system of ellipses exactly as in the cases $q=0$ or $q=\infty$. These systems contain both the circle with radius $\frac{1}{2}\sqrt{2}$. Therefore we are in the case of the asymptotic form of motion; the motion approaches asymptotically to the motion in that circle. The two squares coincide for $q=-4r=0$, and for $q=-4r=\infty$.

§ 51. The case of the degeneration into conic sections ($p=-1$, § 45) occurs here for $q=1$. If we examine the signification of the coefficients, it becomes clear that the surface for these values of the coefficients is a surface of revolution. The relation between ζ and ϕ may be written

$$\zeta(1-\zeta) \sin^2 \phi = -r.$$

From the formulæ of § 41 it follows that the axes of the ellipse are of invariable length; therefore the shape of the ellipses is invariable. In order to prove that the ellipse turns with an uniform angular velocity, and in order to calculate this angular velocity, it is necessary to calculate $\frac{d\theta}{dt}$ from the system of equations:

$$\frac{d\zeta}{dt} = m_1 \zeta(1-\zeta) \sin \phi \cos \phi,$$

$$\zeta(1-\zeta) \sin^2 \phi = -r,$$

$$\tan 2\theta = \frac{\zeta\sqrt{\zeta(1-\zeta)}}{1-2\zeta} \cos \phi.$$

It will be found that the results agree with those Prof. Korteweg arrives at.

The envelope consists of two concentric circles; this might also be deduced from the equation (37, § 46), where $C=0$.

The two enveloping circles coincide for $r=-\frac{1}{4}$; then we are in the case of the uniform motion in a parallel circle of the surface. Another special case we have when $r=0$; the motion takes place in an arbitrary meridian of the surface; one of the enveloping circles has a radius of unit length; the other has contracted into a point.

§ 52. Another interesting case occurs when $r=0$ (if we turn the axes through an angle of 45° , then according to § 49, $q'=1-4r'$).

The relation between ζ and ϕ becomes :

$$\zeta(1-\zeta) \cos^2 \phi = q\zeta(1-\zeta).$$

If not $\zeta=0$ or $\zeta=1$ continually, then

$$\cos \phi = \pm \sqrt{q}.$$

All ellipses of one of these systems correspond to the same value of ϕ . For this case (20, § 30) takes this form :

$$\zeta \sin t \cos(t-\phi) + (1-\zeta) \cos t \sin(t-\phi) = 0.$$

Therefore

$$\zeta = \frac{\sin(\phi-t) \cos t}{\sin \phi}, \quad 1-\zeta = \frac{\cos(\phi-t) \sin t}{\sin \phi}.$$

x and y may be written as functions of t :

$$x = \sqrt{\frac{\cos^3 t \sin(\phi-t)}{\sin \phi}}, \quad y = \sqrt{\frac{\cos^3(t-\phi) \sin t}{\sin \phi}};$$

$$\frac{dy}{dx} = -\sqrt{\frac{\sin 2(t-\phi)}{\sin 2t}}.$$

The shape of the envelope as it is represented in fig. 36 (Pl. VIII.) may be deduced from these equations. It consists of two closed parts, one having four summits, the other four cusps. For decreasing values of q the two parts move towards each other; for $q=0$ they coincide into a square (fig. 33). For increasing values of q one part moves to the circle with radius unity; the other contracts into the origin; this has taken place for $q=1$ (fig. 41).

The envelope of fig. 36 (we include the axes of coordinates) represents the limit form of the envelope of fig. 35 for a constant value of q , if r approaches to zero. For a positive value of r we have two systems of ellipses, each of them having its own envelope. For $r=0$ the two systems are no longer separated; they have in common the double curves along the axes of coordinates. We have to do with an asymptotic form of motion.

For a negative value of r we have but one system of ellipses; if this value is not too little, then the envelope consists of two concentric curves, as is represented in fig. 39.

We may ask in what manner the transition takes place from fig. 39 to fig. 36. In fig. 37 the envelope is drawn for a small (negative) value of r ; there are in the envelope 4 double points and 8 cusps. In fig. 38 r has a greater (negative) value; the cusps have moved towards the double points, whilst the double points move from O. There will belong to a given value of q a certain value of r for which the cusps have coincided two by two; then we are in the case of fig. 39. In order to determine this value of r for which the cusps vanish (that is to say, coincide two by two) we turn the axes of coordinates through an angle of 45° and determine the intersecting points of the envelope with the Y' -axis. Then we get the points corresponding to $\cos \phi' = 0$ and the double points in the Y' -axis. If now the cusps disappear, then for such a double point $\cos \phi' = 0$. $x' = 0$ for $\zeta' = 0$ and $\cos t' = 0$. By substituting $\cos t'$ in (33) (p. 309) we get

$$(1 - \zeta') \cos^2 \phi' - \zeta' = 2 \sqrt{\zeta'(1 - \zeta')} f'(\zeta') \cos \phi' = 2f(\zeta') f'(\zeta').$$

Now we have:

$$f^2(\zeta') = q' \zeta' (1 - \zeta') + r'.$$

$$2f(\zeta') f'(\zeta') = q' (1 - 2\zeta').$$

Therefore

$$(1 - \zeta') \cos^2 \phi' - \zeta' = q' (1 - 2\zeta').$$

Eliminating ϕ' from this relation, and

$$\zeta' (1 - \zeta') \cos^2 \phi' = q' \zeta' (1 - \zeta') + r',$$

we get

$$\zeta' = \sqrt{\frac{r'}{1 - q'}}.$$

If for this value of $\zeta' \cos \phi' = 0$, then

$$q' \sqrt{\frac{r'}{1 - q'}} \left(1 - \sqrt{\frac{r'}{1 - q'}} \right) + r' = 0.$$

Making use of 40 (§ 49), then we find this value of r :

$$r = (q - 1) \left\{ \frac{1}{(q - 2)^2} - \frac{1}{4} \right\}.$$

§ 53. Now that we have examined the special cases we shall give a review of the cases which may occur for $p = -q$ and $l = 0$, for different values of q and r . We may for that purpose follow the scheme of p. 292.

- $q = -\infty$. $r = -\frac{1}{4}q$. The envelope of the system of ellipses is a square (fig. 23).
- $-\frac{1}{4}q < r < 0$. Two systems of ellipses; each of them has a rectangle as envelope (fig. 24).
- $r = 0$. Periodic form of motion; $\zeta = 0$ or 1 continually (fig. 25).
- $-\infty < q < 0$. $r = -\frac{1}{4}(q-1)$. Periodic form of motion; $\zeta = \frac{1}{2}$, $\sin \phi = 0$ (fig. 26).
- $-\frac{1}{4}q < r < -\frac{1}{4}(q-1)$. Two systems of ellipses (fig. 27).
- $r = -\frac{1}{4}q$. The envelope consists of two squares; asymptotic form of motion (fig. 28).
- $0 < r < -\frac{1}{4}q$. Two systems of ellipses (fig. 29).
- $r = 0$. Periodic form of motion; $\zeta = 0$ or 1 continually (fig. 30).
- $q = 0$. $r = \frac{1}{4}$. Periodic form of motion; $\zeta = \frac{1}{2}$, $\sin \phi = 0$ (fig. 31).
- $0 < r < \frac{1}{4}$. Two systems of ellipses; each of them has a rectangle as envelope (fig. 32).
- $r = 0$. The envelope of the system of ellipses is a square (fig. 33).
- $0 < q < 1$. $r = -\frac{1}{4}(q-1)$. Periodic form of motion; $\zeta = \frac{1}{2}$, $\sin \phi = 0$ (fig. 34).
- $0 < r < -\frac{1}{4}(q-1)$. Two systems of ellipses (fig. 35; in fig. 35 r has a very little positive value).
- $r = 0$. Asymptotic form of motion (fig. 36).
- $-\frac{1}{4}q < r < 0$. One system of ellipses (fig. 37 belongs to a very little negative value of r , in fig. 38 r is greater, in fig. 39 still greater).
- $r = -\frac{1}{4}q$. Periodic form of motion in a circle; $\zeta = \frac{1}{2}$, $\cos \phi = 0$ (fig. 40).

- $q=1$. $r=0$. Periodic form of motion in an arbitrary straight line passing through O (fig. 41).
 $-\frac{1}{4}q < r < 0$. One system of ellipses; the envelope consists of two circles (fig. 42).
 $r = -\frac{1}{4}q$. Periodic form of motion in a circle; $\zeta = \frac{1}{2}$, $\cos \phi = 0$ (fig. 43).
- $1 < q < \infty$. $r=0$. Periodic form of motion; $\zeta=0$ or $\zeta=1$ (fig. 44).
 $-\frac{1}{4}(q-1) < r < 0$. Two systems of ellipses (fig. 45).
 $r = -\frac{1}{4}(q-1)$. Asymptotic form of motion (fig. 46).
 $-\frac{1}{4}q < r < -\frac{1}{4}(q-1)$. One system of ellipses (figs. 47, 48, 49).
 $r = -\frac{1}{4}q$. Periodic form of motion in a circle; $\zeta = \frac{1}{2}$, $\cos \phi = 0$ (fig. 50).
- $q = \infty$. $r=0$. Periodic form of motion; $\zeta=0$ or $\zeta=1$ (fig. 51).
 $-\frac{1}{4}q < r < 0$. Two systems of ellipses; each of them has a rectangle as envelope (fig. 52).
 $r = -\frac{1}{4}q$. The envelope of the system of ellipses is a square (fig. 53).

Mechanism with three degrees of freedom.

§ 54. The coordinates of the representative point are given by :

$$x = \frac{\sqrt{a_x}}{n_x} \cos(n_x t + 2n_x \beta_x),$$

$$y = \frac{\sqrt{a_y}}{n_y} \cos(n_y t + 2n_y \beta_y),$$

$$z = \frac{\sqrt{a_z}}{n_z} \cos(n_z t + 2n_z \beta_z).$$

These are the equations of the osculating curves. By eliminating t between these equations two by two we find the projections of the osculating curves on the planes of coordinates. These projections are Lissajous curves; the

osculating curves themselves we can call Lissajous twisted curves.

Such a twisted curve remains enclosed inside a rectangular parallelepiped bounded by the planes

$$x = \pm \frac{\sqrt{\alpha_x}}{n_x}, \quad y = \pm \frac{\sqrt{\alpha_y}}{n_y}, \quad z = \pm \frac{\sqrt{\alpha_z}}{n_z}.$$

In consequence of the variability of the α 's this parallelepiped varies continually. According to (10) (p. 285) the following relations exist between the α 's :

$$\frac{\alpha_x}{pn_x} - \frac{\alpha_y}{qn_y} = \text{constant},$$

$$\alpha_x + \alpha_y + \alpha_z = \text{constant}.$$

Therefore the vertices of the circumscribed parallelepiped move along a twisted curve, situated on an ellipsoid, whose axes lying on the axes of coordinates are in the ratio

$$\frac{1}{n_x} : \frac{1}{n_y} : \frac{1}{n_z}.$$

This curve projects itself on the planes of coordinates as an ellipse or as an hyperbola; *e. g.* the XY projection is an ellipse if p and q are of different sign, an hyperbola if p and q are of the same sign; it is clear that two of the projections are ellipses, the third is an hyperbola.

As the α 's change periodically between definite limits, the vertices will move to and fro between two extreme positions.

§ 55. Besides on the α 's the form of an osculating curve depends on the β 's. However, for an osculating curve described in a definite parallelepiped it depends not on 3, but only on 2 quantities, as is evident when we change the origin of time. We can get :

$$x = \frac{\sqrt{\alpha_x}}{n_x} \cos \left\{ n_x t + 2n_x(\beta_x - \beta_z) \right\},$$

$$y = \frac{\sqrt{\alpha_y}}{n_y} \cos \left\{ n_y t + 2n_y(\beta_y - \beta_z) \right\},$$

$$z = \frac{\sqrt{\alpha_z}}{n_z} \cos n_z t.$$

The form of the osculating curve evidently depends on the

quantities $\beta_x - \beta_y$ and $\beta_y - \beta_z$. So if we put

$$\frac{\sqrt{\alpha_x}}{n_x} = A, \quad \frac{\sqrt{\alpha_y}}{n_y} = B, \quad \frac{\sqrt{\alpha_z}}{n_z} = C, \quad \begin{aligned} 2n_x(\beta_x - \beta_z) &= a, \\ 2n_y(\beta_y - \beta_z) &= b, \end{aligned}$$

then we find :

$$\left. \begin{aligned} x &= A \cos(n_x t + a), \\ y &= B \cos(n_y t + b), \\ z &= C \cos n_z t. \end{aligned} \right\} \dots \dots \dots (41)$$

In the extreme parallelipeds curves are described for which $\phi = 0$ or π (conf. § 24). Therefore

$$2(pn_x\beta_x + qn_y\beta_y + rn_z\beta_z) = 0 \text{ or } \pi.$$

Since

$$rn_z = -(pn_x + qn_y),$$

we may write

$$2pn_x(\beta_x - \beta_z) + 2qn_y(\beta_y - \beta_z) = 0 \text{ or } \pi.$$

Or :

$$pa + qb = 0 \text{ or } \pi^*.$$

§ 56. Let us put in (41) $t = +\tau$ and $t = -\tau$, and let us call the values of x , y , and z belonging to these values of t , respectively x_1, y_1, z_1 and x_2, y_2, z_2 , then we find :

$$\frac{1}{2}(x_1 + x_2) = A \cos a \cos n_x \tau, \quad \frac{1}{2}(y_1 + y_2) = B \cos b \cos n_y \tau, \quad z_1 = z_2.$$

The curve represented by (41) has therefore with respect to directions of chords parallel to the XY-plane as diameter a curve represented by the equations :

$$\left. \begin{aligned} x_3 &= A' \cos n_x t, \\ y_3 &= B' \cos n_y t, \\ z &= C \cos n_z t, \end{aligned} \right\} \dots \dots \dots (42)$$

where

$$A' = A \cos a, \quad B' = B \cos b.$$

To investigate the curves represented by (41) we can start from the curves represented by (42). In fig. 54 such a curve is given perspectively, in fig. 55 (continuous lines)

* The Lissajous twisted curves have been discussed by A. Righi (*Il Nuovo Cimento*, vols. ix. & x., 1873).

by projections for the simple case that we have $n_x : n_y : n_z = 1 : 2 : 3$ (so we are in the case $S=3$); the Lissajous twisted curve begins and ends in two vertices of the circumscribed parallelepiped and is described backwards and forwards.

When a curve (42) is constructed we must bear in mind that

$$x = x_3 - \delta_1 \sin n_x t, \quad y = y_3 - \delta_2 \sin n_y t, \quad z = z_3,$$

where

$$\delta_1 = A \sin a, \quad \delta_2 = B \sin b.$$

So we can think of the curve (41) as described by a point moving along the curve (42) and vibrating at the same time according to the X and Y direction. From this we can see how the osculating curve changes for increasing values of a and b . In fig. 55 the projections are represented (dotted lines) of an osculating curve for $n_x : n_y : n_z = 1 : 2 : 3$ and small values of a and b .

Special cases.—According to § 24 the periodic case occurs only for $\sin \phi = 0$. The circumscribed parallelepiped does not change. The β 's increase uniformly with the time; the osculating curve changes its form; however, invariably $\sin \phi = 0$. The osculating curve is thus represented by (41); a increases uniformly with the time, and $\sin(pa + qb) = 0$.

For $n_x + n_y - n_z = \rho$ in the asymptotic case the motion approaches to $C_2 - \zeta = 0$ or $C_3 - \zeta = 0$, $\phi = \frac{\pi}{2}$ or $\frac{3\pi}{2}$ (§ 23).

For the other relations in the asymptotic case the motion approaches to $\sin \phi = 0$ (§ 24).

Mechanism with four degrees of freedom.

§ 57. The coordinates of the representative point are given by :

$$\left. \begin{aligned} x &= \frac{\sqrt{\alpha_x}}{n_x} \cos(n_x t + 2n_x \beta_x), \\ y &= \frac{\sqrt{\alpha_y}}{n_y} \cos(n_y t + 2n_y \beta_y), \\ z &= \frac{\sqrt{\alpha_z}}{n_z} \cos(n_z t + 2n_z \beta_z), \\ u &= \frac{\sqrt{\alpha_u}}{n_u} \cos(n_u t + 2n_u \beta_u). \end{aligned} \right\} \dots (43)$$

The point moves in a space R_4 . An osculating curve may be called a Lissajous wrung curve. Such a curve remains

enclosed inside a four-dimensional parallelepiped, bounded by the spaces :

$$x = \pm \frac{\sqrt{\alpha_x}}{n_x}, \quad y = \pm \frac{\sqrt{\alpha_y}}{n_y}, \quad z = \pm \frac{\sqrt{\alpha_z}}{n_z}, \quad u = \pm \frac{\sqrt{\alpha_u}}{n_u}.$$

By the variability of the α 's the circumscribed parallelepiped also changes; the vertices move backward and forward between two extreme positions along a wrung curve; this curve lies on a hyperellipsoid whose axes lying along the axes of coordinates are proportional to $\frac{1}{n_x} : \frac{1}{n_y} : \frac{1}{n_z} : \frac{1}{n_u}$. The form of the Lissajous wrung curve in a definite parallelepiped depends, as is found by a change of the origin of time, on the quantities :

$$2n_x(\beta_x - \beta_u), \quad 2n_y(\beta_y - \beta_u), \quad 2n_z(\beta_z - \beta_u).$$

For the osculating curves in the extreme parallelepipeds we have :

$$2n_x(\beta_x - \beta_u) + 2n_y(\beta_y - \beta_u) \pm 2n_z(\beta_z - \beta_u) = l\pi.$$

Furthermore, there is again a periodic case and an asymptotic case (§ 24).

XIX. *Analysis of the γ Rays from Radium D and Radium E.*
By Professor E. RUTHERFORD, F.R.S., and H. RICHARDSON,
M.Sc.*

IN a previous paper † we have given the results of the analysis of the γ radiation from radium B and radium C. The radiation from the former was shown to consist of three types varying widely in penetrating power, and the latter essentially of one penetrating type. In the present paper the γ radiation from radium D and radium E has been examined by a similar method. These radioactive substances are of unusual interest and importance in considering the problem of the connexion between β and γ rays, since the γ rays emitted by radium D and radium E together are exceedingly feeble in intensity compared with the β rays. In this respect they are in marked contrast to the products radium B and radium C, where the γ rays are relatively intense and comparable in energy with the β rays.

In consequence of the short period of transformation

* Communicated by the Authors.

† Rutherford and Richardson, *Phil. Mag.* xxv. p. 722 (1913).

(5 days) of radium E, it has been usual to employ radium D + E in equilibrium as a source of radiation. It has long been known that most of the β radiation emitted from such a source arises from radium E. J. A. Gray* examined the β rays from radium E in a magnetic field and found them to be very complex, giving a continuous spectrum which showed the presence of some rays of velocity close to that of light. This was confirmed by Gray and W. Wilson† using the electric method. Hahn, Baeyer, and Meitner‡ have found that the weak β radiation from radium D consists essentially of two groups of homogeneous rays of velocity $\cdot 33$ and $\cdot 39$ compared with that of light. The question of the β radiation from radium D + E together has been re-examined by Danysz§. While radium D emits groups of β rays of definite velocity, radium E is anomalous in giving a continuous spectrum of β rays in which no definite evidence of groups of homogeneous rays has so far been obtained.

The only definite study of the γ radiation from radium D + E has been made by J. A. Gray||. He found that a comparatively soft type of γ radiation was present, and also a harder type whose mass absorption coefficient in aluminium was 0.4. Gray showed that radium D + E, in consequence of its poverty in γ rays, was an ideal source for studying the production in ordinary matter of γ rays by β rays. The properties of the γ radiation excited in different materials have been studied by him in some detail. Gray had intended to examine the types of γ radiation emitted by radium D and radium E separately, but was unable to complete the experiments before leaving Manchester in 1912.

Preparation of Material.

In order to analyse the γ radiation in detail, it was necessary to obtain very active preparations of radium D + E and to isolate the two components. From the experiments of Gray, it is known that the γ radiation excited in heavy elements by the β rays from radium D + E is greater in amount than the primary γ radiation. It is consequently of importance that the preparation of radium D and of radium E should contain a minimum amount of impurity, and should be tested either on filter-paper or a glass or

* J. A. Gray, Proc. Roy. Soc. A. lxxxiv. p. 136 (1910).

† Gray and Wilson, Phil. Mag. xx. p. 870 (1910).

‡ Hahn, Baeyer, and Meitner, Phys. Zeit. xii. p. 378 (1911).

§ Danysz, Le Radium, x. (1913).

|| J. A. Gray, Proc. Roy. Soc. A. lxxxvii. p. 489 (1912).

aluminium vessel, for under these conditions the γ radiation excited by β rays is reduced to a small amount.

The radium D+E employed was separated from old radium preparations by adding a few milligrams of a lead salt to the solution and precipitating with hydrogen sulphide*. The separation of radium D from radium E was kindly performed for us by Dr. Russell and Mr. Chadwick. They also separated at the same time the radium F (polonium) which has been used by them in a study of the γ rays emitted by that substance. After removal of the radium F by dipping a copper plate into the solution of radium D + E + F, the radium D and radium E were precipitated together as sulphides. The precipitate was dissolved in hydrochloric acid and the radium E almost completely removed by dipping a nickel plate into the solution.

A small quantity of aluminium chloride was added to the radium D solution, and ammonia added. The radium D and lead were precipitated while any copper or nickel present was dissolved in excess of ammonia. The radium D was filtered off and the radiation from it was tested in position on the filter-paper. The amount of aluminium and lead mixed with the radium D on the filter was not more than a few milligrams, and the γ radiation excited in this material was negligible compared with the primary γ radiation.

The radium E which had been separated on the nickel plate was transferred by Dr. Russell and Mr. Chadwick on to an aluminium plate by volatilization under definite conditions in an electric furnace. As is well known, aluminium can only emit a characteristic X radiation of a very easily absorbed type, which could not be detected under the experimental conditions. On the other hand, the characteristic X radiation to be expected from nickel is of the same order of penetrating power as the primary γ rays from radium D.

The purity of the radioactive substances employed was tested by measuring the decay of the β -ray activity of radium E, and the rise of the β -ray activity of the radium D preparation after an initial complete separation of radium E. A series of observations showed that radium D was obtained almost free from radium E, while the radium E did not contain a detectable amount of radium D.

Experimental Method.

The apparatus employed to analyse the γ radiation was essentially the same in principle as that described in our

* See Boltwood and Rutherford, *Phil. Mag.* xxii, p. 586 (1911).

former paper. An aluminium electroscopie ($10 \times 10 \times 10$ cm.) was arranged as shown in fig. 1. The face E of the electroscopie was made of a thin sheet of mica equivalent in stopping

Fig. 1.

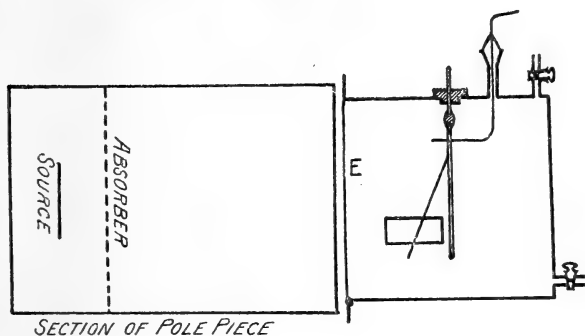

power of the α rays to about 2 cm. of air. The electroscopie was filled by displacement with a mixture of hydrogen and methyl iodide at atmospheric pressure. On account of the small ionization effect of the γ rays from the radioactive materials under examination, it was necessary to allow a comparatively wide beam of γ rays to enter the electroscopie. The β rays were removed by a strong magnetic field, the pole-pieces being about 6 cm. apart. In most experiments the source was placed in the magnetic field about 12 cm. from the electroscopie, and the absorbing layers were placed directly in front of the source, as shown in the figure. All exposed surfaces were covered with thick cardboard in order to reduce the possibility of excitation of γ rays by β rays to a minimum.

Analysis of the γ Rays from Radium D.

The absorption curve of the γ rays from radium D was obtained immediately after its separation from radium E. No sensible change either in the intensity of the γ rays or in the shape of the absorption curve was observed with the growth of radium E in the preparation. This indicates, as is shown later by another method, that the γ radiation from radium E is very weak in intensity compared with the γ rays from radium D. In all five determinations were made with different preparations of radium D. The numbers obtained in the individual experiments under somewhat different

conditions are given in the following table as an illustration of the accuracy of the individual measurements.

Thickness of Aluminium.	A.	B.	C.	D.	E.
0 mm.....	100	100	100	100	100
·065	74·0	74·7	75·2	77·3	77·5
·130	57·4	57·9	58·6	58·7	60·5
·195	45·2	45·7	45·4	46·4
·260	35·4	36·8	36·9	37·3	36·5
·390	24·5	25·2	24·8	25·5	24·3
·56	16·1	15·9	16·3	15·4	15·8
·82	10·8	10·8	10·5	10·0
1·12	8·3	8·4	8·3	7·5	7·5
1·97	6·2	5·7	5·1	5·6
3·94	4·3	4·7	4·2	4·2

- A. Rather a large amount of material, consisting chiefly of aluminium. Maximum activity was 3 divs. per min. $\mu=45$.
- B. Thin preparation. Maximum activity 7 divs. per min. $\mu=45$.
- C. Same preparation as B. Measurements taken a fortnight later. $\mu=46$.
- D. Thin preparation, containing only a small amount of aluminium and lead. Preparation was placed on a filter-paper and mounted on cardboard. Maximum activity 20 divs. per min. $\mu=44$.
- E. Same preparation as D, only in this case the filter-paper was simply suspended between the poles of magnet. $\mu=44$.

Fig. 2.

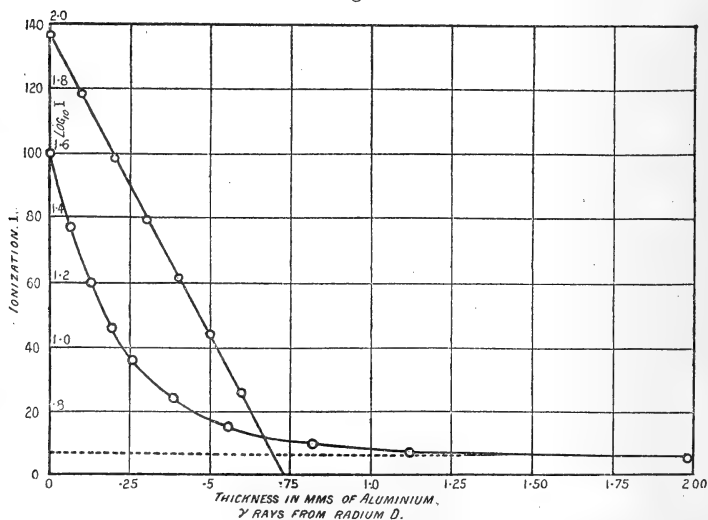

One of the several curves obtained is shown in fig. 2. It is seen that the greater part of the γ radiation is absorbed

by about 1 mm. of aluminium. A small amount of a more penetrating type of radiation is also present. The curve was analysed as in previous experiments. The soft part of the radiation was found to be absorbed exponentially in aluminium (see logarithmic curve fig. 2), the value of the absorption coefficient μ being 45, 45, 46, 44, 44 in the five distinct experiments, giving a mean value $\mu = 45$ (cm.)⁻¹.

The absorption curve for the penetrating radiation is shown in fig. 3, the logarithm of the ionization being plotted as ordinate. It will be seen that the points lie nearly on a

Fig. 3.

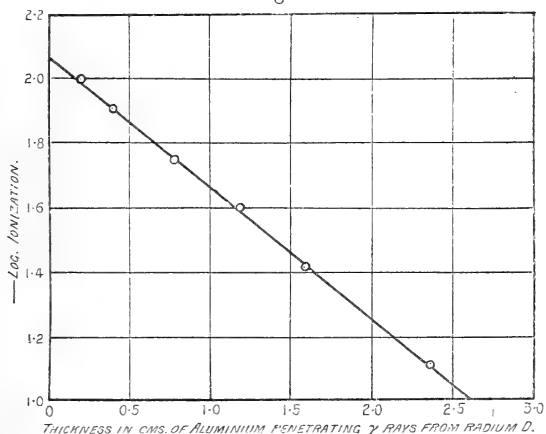

straight line, showing that the γ rays are absorbed according to an exponential law. The mean value of the absorption coefficient for several experiments was found to be 0.99 (cm.)⁻¹ in aluminium. It will be seen from the figure that only about 7 per cent. of the total γ -ray ionization is due to the more penetrating type of radiation. As the maximum ionization obtainable under the experimental conditions was about 19 divisions per minute in the electroscope, the amount due to the penetrating rays was only between 1 and 2 divisions a minute. It is consequently difficult, when dealing with such small effects, to obtain a very accurate value of the absorption coefficient of this radiation. Several experiments were made, the values of μ varying between 0.97 and 1.02. The radiation was in all cases absorbed according to an exponential law, indicating that the rays consisted of one homogeneous type. The absorption curves of both types of radiation were also determined in carbon as well as in aluminium. Allowing for the difference in the absorption coefficients, the curves

for carbon were found to be identical in character with those obtained for aluminium, and the proportion of hard to soft radiation was the same in both cases. This agreement indicates that the measurement of the absorption is not complicated to an appreciable extent by the excitation of γ rays in the absorbing screens by the primary γ rays from radium D. Very active preparations of radium E were obtained, and before the application of the magnetic field the β -ray activity was found to be about 2000 divisions per minute. On applying the magnetic field the amount of γ radiation observed never gave more than half a division per minute. The absorption curve of this radiation was examined in aluminium, but could not be determined with much accuracy on account of the smallness of the effects. The absorption curve obtained is shown in fig. 4. It will be seen that the curve is very similar in shape to that obtained for radium D.

Fig. 4.

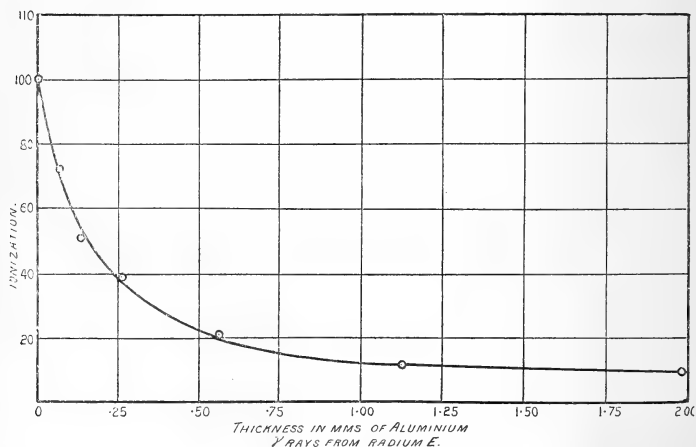

The results, however, are not of sufficient accuracy to analyse the constituents of the radiation with any certainty. It was of great importance to settle whether the small γ radiation observed is to be ascribed to radium E or to the presence of a small amount of radium D as impurity. For this purpose, the γ -ray activity of the radium E preparation was examined over several weeks. It was found that the amount of γ radiation decreased at the same rate as the β -ray activity, and ultimately became too small to measure. This result showed conclusively that the γ radiation must arise from radium E and not from radium D. It would appear

that the emission of β rays from radium E is accompanied by an exceedingly minute γ radiation of which the soft type has about the same absorption coefficient as that from radium D. It appears fairly certain that this γ radiation is to be ascribed to the atoms of radium E, and is not excited by the β rays in the surrounding inactive matter.

*Relative Intensity of the γ Rays from Radium D
and Radium E.*

It is of importance to obtain an estimate of the relative magnitude of the β and γ radiation emitted by radium D and radium E. This was done by measuring the β -ray activity of the sources under precisely the same conditions as the γ -ray activity. The ionization in the electroscope of fig. 1 was determined with and without the magnetic field. The preparations were placed 12 cm. from the mica face E of the electroscope, and the pole-pieces were 6 cm. apart. Under these conditions, the β -ray activity of the radium D preparation was 300 divisions per minute, and the γ -ray activity 19 divisions per minute. On the other hand, the β -ray activity of the corresponding radium E preparation was 1400 divisions per minute, and the γ ray activity only 0.48 division per minute. Even without allowing for the partial absorption of the soft β rays from radium D in the air before entering the electroscope, it is obvious that there is a very marked difference between the ratios of the β - and γ -ray activity of the two preparations.

Summary.

It has been shown that radium D emits two types of γ radiation for which $\mu=45$, and 0.99 (cm.)^{-1} in aluminium. Relatively to radium D, radium E emits a very weak γ radiation, and not more than two per cent. of the γ radiation given out by radium D + E in equilibrium is to be ascribed to radium E. In other words, the transformation of each atom of radium D is accompanied, on the average, by 50 times the amount of γ radiation from an atom of radium E. The soft type of radiation $\mu=45$ from radium D and radium E is slightly less penetrating than the corresponding radiation from radium B. There appears to be little doubt that this radiation corresponds to the characteristic radiation of the L type to be expected from an element of atomic weight 210. The values of the absorption coefficients of the types of γ radiation from radium B, radium C, radium D, and radium E

are collected together in the following table. The density D of aluminium was 2.72.

	Absorption coefficient μ in Aluminium.	Mass absorption coefficient μ/D in Aluminium.
Ra B.....	$\left\{ \begin{array}{l} 230 \text{ (cm.)}^{-1} \\ 40 \text{ ,,} \\ 0.51 \text{ ,,} \end{array} \right.$	$\left\{ \begin{array}{l} 85 \text{ (cm.)}^{-1} \\ 14.7 \text{ ,,} \\ 0.188 \text{ ,,} \end{array} \right.$
Ra C.....	0.115 ,,	0.0424 ,,
Ra D.....	$\left\{ \begin{array}{l} 45 \text{ ,,} \\ 0.99 \text{ ,,} \end{array} \right.$	$\left\{ \begin{array}{l} 16.5 \text{ ,,} \\ 0.36 \text{ ,,} \end{array} \right.$
Ra E.....	Nearly the same types of radiation as from radium D, but relatively very feeble.	

We are much indebted to Dr. Russell and Mr. Chadwick for the great care and trouble they have taken in purifying the preparations of radium D and radium E employed in these experiments.

University of Manchester,
June 1913.

XX. *The Existence of Uranium Y.*

To the Editors of the Philosophical Magazine.

GENTLEMEN,—

IN the May number of the Philosophical Magazine, p. 710, A. Fleck has published a paper calling in question the existence of uranium Y, a branch product of uranium described by me in a previous paper*. He is unable to find any trace of the existence of this body in pure uranium compounds, and ascribes to the presence of thorium products the abnormal results obtained by me for the initial decay of the soft β rays of uranium X which I attributed to the existence of a new product uranium Y.

Even if my preparations were not wholly free from traces of thorium and its products, it is nevertheless extremely difficult to understand how the presence of such thorium products as would be separated with the uranium X in the methods employed by me would simulate the appearance of a single body expelling soft β rays and decaying *from the time of separation* with a period of about 1.5 days. Moreover, it

* Phil. Mag. vol. xxii. p. 431 (1911).

must further be supposed that the thorium or product which grows this body remains with the uranium after the uranium has been freed from uranium X.

Had Fleck published the absorption and decay curves, not only for pure uranium X, but also for uranium X separated from uranium known to contain thorium, then comparison of these curves with those published in my paper would settle this point. Until this is done, however, my results cannot be held to be disproved. The fact that he did not succeed in separating uranium Y in the material he used does not necessarily prove it does not exist, for he did not use exactly the method employed by me. Its separation, as I said in my paper, is a matter of some difficulty.

Since he has been unable to find any trace of uranium Y in the uranium he used, and as I feel confident that my uranium was free from thorium and its products, it is obvious that repetition of the work is necessary to decide which of us is right. I am unable to do this with advantage until more precise information is available as to the exact methods of purification of the uranium salts employed by Fleck.

G. N. ANTONOFF.

Chemical Laboratory of the Academy of Sciences,
St. Petersburg.
June 1913.

XXI. *The Deposit upon the Poles of Metallic Arcs.* By
W. G. DUFFIELD, *D.Sc., Professor of Physics, University
College, Reading*.*

[Plates IX. & X.]

DURING some experiments upon the spectrum emitted by an iron arc burning in air, it was frequently observed that one or other of the poles was covered with a brownish deposit after the arc had been burning for some time. This deposit was remarkable for its organic appearance, resembling on different occasions a delicate coral formation, a tree-like growth and a feathery structure; sometimes it formed an even powder spread over the upper pole. Of other metals which have been similarly examined copper has proved the most interesting, the growths upon poles of this metal being confined to one type, and since there is some evidence that from a corresponding type in the iron arc the

* Communicated by the Author.

other forms of iron deposit are derived this copper growth is described first.

The Copper Arc.

The copper rods used were 1 cm. in diameter and were usually held horizontally in a hand-fed arc, the arc itself springing across the base of the gap and its vapour curling upwards fairly evenly between the two poles. The current was either derived from town mains supplying continuous current at 200 volts or from a storage battery of 50 cells. The current was reduced by rheostats to about 4 amperes, the potential difference across the terminals being then between 25 and 40 volts. These were not the only conditions under which the growths were formed, but they proved very favourable. When the arc-length was more than 3 mm. they were not produced with a current greater than 6.5 amperes, nor were they formed with a current of 9.5 amperes when the gap was 2 mm., indicating that both heavy currents and long arcs militated against their formation.

Under favourable conditions of current strength and arc-length delicate tree-like structures rapidly grew from the negative pole in the direction of the anode, eventually bridging the gap and possibly assisting in the passage of the current. These growths invariably made their appearance upon the cathode and never upon the anode, whether the arc were vertical or horizontal and whatever the direction of the current. The growths were nearly black and consisted it would seem of cupric oxide. They were extremely light and fragile, and though urged upwards by the hot gases rising from the horizontal arc, only those round the rims were permanently deflected, and then but slightly; the others were chiefly influenced by the direction of the electric field.

The arc was examined under a microscope with the aid of coloured glass. Starting with copper poles which had been filed flat before the arc was struck, the negative pole quickly became dotted with numerous tiny black spikes, which rapidly developed normally to the surface and remained as a rule straight until a point was reached at which branching began, when two or usually more laterals started out from the main trunk. These sent out sub-laterals which in their turn developed tiny off-shoots, but as the growth of the laterals was not as rapid as that of the main stem, the whole growth remained fairly open and resembled a tree of the monopodial type in which the main axis predominates. The phenomenon was very beautiful to watch, the miniature trees being of

great variety, each growth glistening with numerous metallic globules which it had caught from the disintegration of the metal poles.

A marked feature of these structures was the increase in their rate of growth as they approached the positive pole; in some instances the gap appeared to be instantaneously bridged, and great difficulty was experienced in determining how the poles were finally spanned, frequently it seemed that a molten drop leaped from the apex of the deposit to the positive pole, leaving in its trail a fine thread which was so quickly formed that it was free from lateral branches. The most rapid changes occurred when the arc gave rise to a sudden outburst of vapour, this it occasionally did with almost explosive violence, instantly destroying the numerous growths in its vicinity, but these were quickly replaced by a new forest of growths completely formed and as profuse as they had been before the outburst. Their production seemed to be almost instantaneous and as though they were suddenly crystallized in their final form.

Not infrequently the growth completed its effort to reach the positive pole by stretching out towards it as a whole as though it were viscous, the thinnest parts stretching most. Such a growth was in tension, and when it broke the two ends were often thrown with some force upon their respective poles.

When cold the growth was brittle and frequently dropped off the electrodes. If the negative pole to which the growths were attached remained connected to the terminal of the battery after the arc was stopped, the growths more or less retained their form, but if disconnected the laterals collapsed upon the stem and the stem upon the pole, clearly demonstrating that their formation is largely conditioned by electrostatic repulsion. Incidentally it involves the material of which they are composed being conducting.

To test whether under any circumstances the growths can be cultivated upon a positive pole, a copper wire was introduced above a horizontal arc produced by a storage battery supplying 100 volts with suitable resistances in circuit. The negative pole was earthed and so was one terminal of a battery consisting of a large number of small secondaries whose other terminal was connected with the exploring electrode. The potential difference at the terminals of the arc was about 30 volts; when a positive potential of 100 volts was applied to the third pole placed about 2 mm. above the gap, the tree-like structures sprang almost instantly into existence and grew with vigour. The growth became still

more abundant when the pole was given a negative potential of the same amount (Pl. IX. fig. 1). Using lower potentials, the difference between positive and negative became still more marked,—below about 70 volts growths were not formed upon the positive pole.

Further trials were made with a third electrode of different shapes varying from spherical to pointed which was held at distances varying from 2 mm. to about 2 cm. above the arc, but well within the stream of vapour that rose from it. Using the spherical terminal no growth formed upon it when its potential was either +78 or -78 volts, though some brown powder collected; but a vigorous growth was produced when the electrode was pointed and the same potential used, there was, however, always a marked preference of the growth for the negative sign. This growth often extended for 2 or 3 cm. up the needle-point, but was more prominent at the tip.

The Iron Arc.

Observations of an iron arc burning in air were also made microscopically and a growth corresponding to that observed in the copper was seen. Its laterals were more fully developed giving it a feathery appearance, and it was rather more delicate and flexible and more susceptible to draughts of air, but when cold it was not so brittle. Unlike the copper deposit some of this growth occurred upon the anode, but always to a very much less extent than upon the cathode. Its rate of growth was not appreciably accelerated in the proximity of the anode, but remained fairly constant across the arc, but when it touched the anode it adhered to it, and separation of the poles spun it out to a greater degree of fineness.

The difficulty of photographing these growths is very great, both on account of their fragility and because they are of such gossamer fineness that they will not readily remain still long enough. Besides, unless they can be photographed during the running of the arc their appearance changes—even though the cathode be not disconnected from the supply the laterals collapse to some extent. Pl. X. fig. 4, shows some of the feathery growths which cohered upon the stoppage of the arc, they originally bridged the gap from the cathode to the anode (below), but the poles have been separated and some of the fine filaments have been broken. These filaments are less than 1/100 mm. in diameter, and

still finer ones have been observed. This type of iron growth is better shown in Pl. IX. fig. 2, where they are seen much magnified growing from a needle-point charged to a negative potential of 100 volts about 2 mm. above a horizontal arc between iron poles. They are easily distinguishable from the corresponding copper growths in Pl. IX. fig. 1.

To produce these growths a small hissing arc proved most favourable and they were best developed by a current of about 4 amperes.

In the iron arc the growths seem rather more influenced by convection currents than by the electric forces, and much of the deposit forms upon the edges of the upper pole; here, especially if the pole be negative, it accumulates, and may become massive. Though these deposits are of a much coarser nature than those within the arc, they nevertheless assume forms reminiscent of organic structures, and are the result of further deposition upon the type of growth first described.

A general view of this growth is seen in Pl. X. fig. 1, which shows the negative pole at the top after the poles have been separated, the characteristic positive bead being seen on the lower pole. The photograph is an enlargement, the actual diameter of the poles being $\frac{3}{8}$ inch. The deposit, which is of rather an indeterminate colour ranging from brown to orange-yellow, is seen to be most copious round the rim of the crater, but it also extends in ridges for about half an inch up the side of the top pole, thinning off to an even layer of a powdery nature higher up.

A growth on the right-hand side of the pole is seen turned upwards under the influence of the hot vapour rising from the arc. In fig. 2, a coral-like growth at the corner of the top pole is shown more highly magnified. The current used to produce the growths in figs. 1 and 2 was heavy, varying from 10 to 14 amperes. Fig. 3 illustrates a modified form of the feathery type, some condensation having occurred upon it. The filaments are no longer to be seen, and under a high power the whole has the appearance of a nodular aggregate.

The deposit collected from the poles was found to be magnetic; that it is not pure magnetic oxide is, however, shown by its reddish colour. It may be ferric oxide mixed with the magnetic oxide or else with particles of iron—though probably the former. It has not been determined whether oxidation precedes or succeeds deposition.

The Silver Arc.

Arcs struck between poles of silver $\frac{1}{2}$ inch in diameter and also between poles $\frac{1}{4}$ inch in diameter showed no deposit of the above nature even after half an hour's run. There were in the horizontal arc small inconspicuous lumps upon the negative pole of what looked under a magnifying glass like an aggregate of tiny crystals in no regular form.

In these experiments arc-lengths of 1.5 to 2 mm. were used with a current of 4 amperes, and the voltage varied from 25 to 32 volts across the arc.

The introduction of a third pointed electrode about 2 mm. above the horizontal silver arc caused no deposition upon it if it were positively charged to 100 volts, but if negatively charged 50 volts were sufficient to ensure a vigorous growth upon the point and some distance up it. This growth was very like that formed in the copper arc, but was hardier and seemed a little heavier; it was black in colour, indicating that it consisted of an oxide of silver. The positive needle is not without some effect as a layer of a powdery nature slowly accumulates upon it, but it does not exhibit the structure presented by a needle charged negatively. Pl. IX. fig. 3 shows the silver growth upon a needle-point at a negative potential of 100 volts after the arc below had been burning for 3 minutes. In fig. 4 the needle is seen with a powdery deposit; it had been connected to the positive terminal of the 100 volt battery, the other terminal of which was earthed. No growths were formed though the arc had been burning for 9 minutes.

Arcs between different Metals.

Experiments were made with horizontal arcs of pairs of metals, *e. g.* copper and iron, silver and iron, silver and copper, iron and carbon, to ascertain the effect of the anode upon the cathode growth. When iron and copper were used and the copper was the cathode, the growth upon it was very meagre indeed, consisting partly of iron (it was magnetic) which had evidently been derived from the positive pole. When the iron was negative the growth was also magnetic and very profuse.

Using a silver pole with iron or copper as the other electrode, no appreciable growth was obtained when the silver was negative, but when it was positive the growths characteristic of iron or copper appeared on the cathode.

An arc between carbon and iron poles was investigated, but no growths were produced because the arc covered a larger area and must have destroyed any incipient growth; moreover, the carbon acted as a reducing agent upon the oxide, the iron remaining bright and metallic, even in those regions from which the arc had actually sprung.

Effect of cooling.—That the condensation of the vapour into the forms described was not occasioned by cooling alone was shown by introducing cool objects insulated and without charge into it, a meagre powdery deposit was obtained in such cases.

Introduction of different metals.—The effect of introducing charged electrodes of different metals above a copper arc was also investigated, but no differences in the nature of the growths were discovered,—this precludes the growths being derived from the metal of the pole upon which they form, a process which was suggested by the resemblance of these forms to organic growths. Further proof of this conclusion is furnished by experiments upon arcs in which the electrodes were of different metals.

Rotation of the growths.—The growths were frequently observed to rotate, the whole mass of foliage turning round about the main trunk or the laterals revolving round a branch. This may be due to chance convection currents or may be connected with the rotation observed by Trotter*, though slower than the rate he found. The direction of rotation of the deposit was not constant but more frequently in the direction in which it would be necessary to turn a right-handed screw advancing from the negative towards the positive pole.

Discussion of the Phenomenon.

From the foregoing description of the metallic growths their outstanding features are seen to be (1) their preference for the cathode, (2) their formation upon a third electrode if its potential be sufficiently high, and especially if it be negatively charged, (3) their preference for a pointed electrode, (4) their derivation from the material of either the anode or cathode but chiefly from the latter, (5) their organic form, which is different for different metals, (6) the rapidity of their development as they approach the anode and when an outburst of vapour occurs.

* 'The Electrician,' vol. xxxiii. p. 297 (1894).

In interpreting these experiments it is to be borne in mind that the arc itself only occupies a small portion of the gap between the poles, and that it usually burned at the bottom of a pole-space 2 mm. wide, the diameter of the poles being about 1 cm. The growths usually appeared above the arc proper.

Three lines of argument are now developed to account for these phenomena. (1) It is known that the gases rising from a metallic arc are ionized, and we expect the space between the poles above the arc to be filled with a mixture of ions derived from the metals and the air, some of the particles being charged positively, some negatively, others being neutral. At first sight it might be expected that of these the positives would be drawn to the cathode, the negatives to the anode, and that the neutrals would escape with the convection currents; but different observers have noted that the ions are only removed from the arc with difficulty, and it seems that the neutral atoms are not the sole constituent of the escaping vapours in spite of the electric field between the poles, which with a 2 mm. gap amounts to about 200 volts per cm.

This potential gradient is sufficient in the case of copper and iron to sweep some at least of the metallic vapour onto the cathode, where it assumes the organic form under discussion, but a larger difference of potential is required to accomplish this for the ionized silver vapour. In all cases a greater potential difference was necessary to sweep the material onto the anode. The explanation of this seems to consist, at least in part, in the greater mobility of the positive ions. It is true that in air alone the negative ions are more mobile, but their mobility has been shown to be greatly reduced when the air is moist* owing to the deposition of moisture upon them, the mobility of the positive ions being but slightly affected, as they do not so readily act as centres of condensation. C. T. R. Wilson† found later that under conditions favourable for the further deposition of moisture, the negative ions tended to monopolize the whole of the aqueous vapour unless special precautions were taken. It is suspected that in the experiments with the arc the negative ions act in the same way, and provide the chief source of nuclei for the condensation of the metallic vapour, and that they give rise to a much more massive aggregate than do the positive ions.

* Zeleny, *Phil. Trans. A.* cxcv. p. 193 (1900).

† C. T. R. Wilson, *Phil. Trans.* cxcii. p. 289.

This would account for a smaller electric force being required to attract the positive ions to the cathode than is required between the negative ions and the anode. If a difference in bulk is one cause of the different actions of the positive and negative ions, it is reasonable to assume that the absence of a silver deposit is due to its being too heavy to be moved by the electric force upon it, although it can be formed upon a third pole at a higher potential than can be maintained between the poles of the arc itself. The silver cluster would, for a given number of molecules, be expected to be heavier than the copper and the copper heavier than the iron. This has been borne out by the series of experiments in which it has been determined that the iron, copper, and silver deposits are formed with greater difficulty as the atomic weight increases.

Ehrenhaft's* experiments upon the charge carried by the ions derived from metallic arcs necessitated the measurement of their velocities both in the electric field and under the influence of gravitation. His determinations led him to the conclusion that the velocities of the positive and negative ions are the same to within 5 per cent. if the mean values be taken, but too much stress must not be placed on this conclusion because the velocities of individual particles varied by as much as 60 per cent. We are not concerned so much with the mean velocity as with the maximum velocity with which they can be urged in the electric field, and this might easily be different for the two types of ions without greatly affecting their mean value. Nevertheless the experiments do not confirm the hypothesis that the mobilities of the two are different, though the objection is not I think very formidable since Ehrenhaft used an electric field of 2.5 electrostatic units, whereas those employed in the above experiments were considerably smaller, and it has already been stated that the differences between the positive and negative pole rapidly diminished as greater potential differences were employed.

(2) Another cause of the differences between the action of the two poles is the discharge of electrons from the cathode (above the region of the arc proper) both under the influences of its high temperature (thermal emission) and of the intense ultra-violet light incident upon it.

On this view the stream of electrons provides nuclei for the vapour which is not yet condensed from the rising and rapidly cooling products of the arc, those particles that

* Ehrenhaft, *Phys. Zeit.* x. p. 308 (1909).

condense in contact with the cathode adhere to it by reason of cohesive forces, while some few, although negatively charged, may be sufficiently near to be attracted by it. The same influences are at work upon the surface of the anode, but the electrons are bound by the positive charges there. The growth itself, however, when once begun takes part in this action, and condensation of metallic deposit ensues upon its apex.

(3) Further, the predominating influence of the cathode is assisted by the action of ultra-violet radiation upon the particles in the vapour above the arc, which promotes the emission of electrons from them. The particles are consequently left with a positive charge, which persists until a collision occurs between them and one of the vagrant electrons. Though not permanently positive, there is on the whole an increase in the number of ions which are at any instant charged with that sign, and these are more readily swept upon the pole than are the neutral masses. Ehrenhaft does not remark an excess of positive ions, but as the gases in his experiment appear to have been sucked from one part of his apparatus to another, recombination may have taken place after the particles had ceased to be under the influence of the ultra-violet light.

The progress of the growths.—Once having started, the growth extends by “the action of contiguous particles,” the first small deposit acting like a point and exerting a superior attraction upon the vagrant ions. The growths extend outwards along a line of force, and while in a homogeneous vapour there should be nothing to deviate the growths from a straight path from the cathode to the anode, some irregularities in the deposit naturally occur where particles of various sizes and of doubtful sphericity abound, and when an irregular mass is deposited several fresh shoots start out inclined to the main stem. These laterals are in general at equal distances from one another and perpendicular to the main stem because they are subject to mutual electrostatic repulsion.

The organic appearance of the growths.—Though the copper and silver growths are very alike they differ materially from those derived from iron. They seem characteristic of their respective metals rather than of the electric forces involved in their production, because they remain true to type whether the potential difference be 50, 100, or 200 volts. The property which determines these differences is thought to be the flexibility of the filaments of the different metals. It is

obvious that the laterals which are at right angles to the main stem or axis of the growth experience little or no electric force which might occasion the further deposition upon them necessary for their extension, but if they are sufficiently flexible to bend round towards the anode they are as favourably oriented as the main axis itself. The iron growth appears to be capable of doing this and hence its foliage is profuse and dense, but the copper and silver filaments are more brittle and less flexible and their laterals remain undeveloped, the main axis being consequently more pronounced; this may account for the organic appearance of the deposit: in this connexion it is interesting to note that experiments upon the growth of various crops indicate that they too thrive best when they spring from a soil discharging electricity:—it is pertinent to inquire if their growth is also regulated by the relative mobilities of positive and negative ions.

The rapidity of the growth in the neighbourhood of the anode is evidently occasioned by the increase in the steepness of the potential gradient close to it as the growth (which is in connexion with the cathode and consequently at the same potential) extends towards it, while the efficacy of a pointed electrode is simply explained by the greater electric force in the proximity of a charge of large surface density, assisted it may be by the incidence upon it of ultra-violet light in the manner already suggested to account for the extension of a growth that has already started between the poles. Moreover, near it the electric field is very strong and not uniform, and any conducting particles would be urged towards it.

The origin of the material of the growths.—The experiments upon arcs between poles of dissimilar metals point to the origin of the material of the growth being the cathode—though this is not invariably the case, since a meagre deposit of iron may be found upon a cathode of copper. This conclusion is not in conformity with the view that the expulsion of positive ions from the anode is the sole source of positive ions, such ions seem to be more readily derived from the material of the cathode, probably through the impact of negative electrons ejected from the cathode with the vapour that has diffused from that pole.

In the following Table (p. 344) details are given of a few typical experiments.

I am indebted to Mr. G. G. E. Collis for taking the photographs reproduced in Pl. X., and for help in the observations, and to Dr. Sadler for assistance in many of the experiments.

Physical Laboratory,
University College, Reading.
Feb. 25, 1913.

XXII. *The Emission of Electrons from Tungsten at High Temperatures: an Experimental Proof that the Electric Current in Metals is carried by Electrons.* By O. W. RICHARDSON, M.A., D.Sc., F.R.S.*

THAT the carriers of the negative thermionic current from incandescent solids are negative electrons was first established by J. J. Thomson†. In 1901‡ the writer developed the view that this emission of negative electrons occurred by virtue of the kinetic energy of thermal agitation of some of the electrons in the solid exceeding the work which was necessary to overcome the forces which tend to retain them in the body and which prevent them from escaping at lower temperatures. This conception has proved a very fruitful one, and its consequences have been verified in a number of ways. It has provided a quantitative explanation of the variation, with the temperature of the body, of the number of electrons emitted. It led to the prediction of a cooling effect when electrons are emitted by a conductor, and a corresponding heating effect when they are absorbed. Both these effects§ have since been detected experimentally, and found to be of the expected magnitude, within the limits of experimental error. The magnitude and distribution of energy of the emitted electrons has been found by experiment to be that given by Maxwell's law||, in accordance with the requirements of the theory. Finally, the same general train of ideas has led to useful applications in the direction of the

* Communicated by the Author.

† *Phil. Mag.* vol. xlviii. p. 547 (1899).

‡ *Camb. Phil. Proc.* vol. xi. p. 286 (1901); *Phil. Trans. A.* vol. cci. p. 497 (1903).

§ Richardson and Cooke, *Phil. Mag.* vol. xx. p. 173 (1910), vol. xxi. p. 404 (1911). Cooke and Richardson, *Phil. Mag.* vol. xxv. p. 624 (1913).

|| Richardson and Brown, *Phil. Mag.* vol. xvi. p. 353 (1908); Richardson, *Phil. Mag.* vol. xvi. p. 890 (1908), vol. xviii. p. 681 (1909).

theory of metallic conductors*, contact potential†, and photoelectric action‡.

It has long been known that ions are emitted in a number of cases in which solids react chemically with gases. The recent experiments of Haber and Just§ indicate that the alkali metals liberate electrons when they are attacked by certain gases. It seems likely, from various considerations||, that effects of this nature would account for most of the emission from heated sodium which was measured by the writer¶. In consequence of this conclusion, together with the results of a number of experiments which are at first sight in conflict with the theory referred to at the beginning of this paper**, the view appears to have become rather prevalent that the emission of electrons from hot bodies is invariably a secondary effect, arising in some way from traces of chemical action. That this view is a mistaken one is, I think, conclusively shown by the following experiments which I have made with tungsten filaments.

The tests to be described were made with experimental tungsten lamps carrying a vertical filament of ductile tungsten which passed axially down a concentric cylindrical electrode of copper gauze or foil. The tungsten filaments were welded electrically in a hydrogen atmosphere to stout metal leads. These in turn were silver soldered to platinum wires sealed into the glass container. The lead to the copper electrode was sealed into the glass in the same way. The lamps were exhausted with a Gaede pump for several hours, during which time they were maintained at a temperature of 550–570° C. by means of a vacuum furnace. The exhaustion was then completed by means of liquid air and charcoal, the tungsten filament meanwhile being glowed out by means of an electric current at over 2200° C. Most of the tests were made after the furnace had been opened up and the walls of the lamps allowed to cool off. The walls were always considerably above the temperature of the room on account of the heat radiated by the glowing filament.

The processes described are extremely well adapted for

* Richardson, *Phil. Mag.* vol. xxiii. p. 594 (1912), vol. xxiv. p. 737 (1912).

† Richardson, *Phil. Mag.* vol. xxiii. p. 263 (1912).

‡ Richardson, *Phil. Mag.* vol. xxiv. p. 570 (1912); Richardson and Compton, *Phil. Mag.* vol. xxiv. p. 575 (1912).

§ *Ann. der Phys.* vol. xxx. p. 411 (1909), vol. xxxvi. p. 308 (1911).

|| Cf. Fredenhagen, *Verh. der Deutsch. Physik. Ges.* 14 Jahrg. p. 384 (1912); Richardson, *Phil. Mag.* vol. xxiv. p. 737 (1912).

¶ *Phil. Trans. A.* vol. cci. p. 497 (1903).

** Cf. Pring and Parker, *Phil. Mag.* vol. xxiii. p. 192 (1912).

getting rid of the absorbed gases and volatile impurities which form such a persistent source of difficulties in experiments of this character. Unless some such treatment is resorted to, the metal electrodes and glass walls of these tubes continue to give off relatively large amounts of gas under the influence of the heat radiated from the filaments, and it has always been possible that this evolution of gas might have played an important part in the electronic emission. The mode of treatment used, for which I am largely indebted to the experience and suggestions of Dr. Irving Langmuir, of the General Electric Company's Research Laboratory at Schenectady, N.Y., seems very superior to anything in this direction which has previously been published.

Tests have been carried out covering the alternative hypotheses, as to the possible mode of origin of the electronic emission, which are enumerated below:

(1) The emission is due to the evolution of gas by the filaments.

The lamp and McLeod gauge were cut off from the rest of the apparatus by means of a mercury trap, the volume being then approximately 600 c.c. A filament 4 cm. long, giving a thermionic current of $\cdot 064$ amp., was found to increase the pressure from zero to $< 1 \times 10^{-6}$ mm. in five minutes. The number of molecules N_1 of gas given off is therefore $2 \cdot 13 \times 10^{13}$. The number of electrons given off is $N_2 = 1 \cdot 2 \times 10^{20}$. The number of electrons emitted for each molecule of gas evolved is thus $N_2/N_1 > 5 \cdot 64 \times 10^6$.

In the above experiment a liquid-air trap was interposed to keep the mercury vapour off the filament. In another experiment with a filament 8 cm. long this was not the case, and with a current of $\cdot 050$ amp. the pressure rose in thirty minutes to a value which was too small to measure, but which was estimated as less than 10^{-7} mm. The corresponding value of N_2/N_1 is $2 \cdot 6 \times 10^8$. In this case the current was unaffected when the mercury vapour was subsequently cut off by liquid air (a change of 0.4 per cent. would have been detected).

The magnitude of the above numbers effectually disposes of the idea that the emission has anything to do with the evolution of gas.

(2) The emission is caused by chemical action or some other cause depending on impacts between the gas molecules and the filaments.

In a tube with a filament 1.4 cm. in length and having $1 \cdot 65 \times 10^{-2}$ cm.² superficial area, the pressure rose to

$< 2 \times 10^{-6}$ mm. in 5 minutes with an emission of .050 amp. If the gas is assumed to be hydrogen, which makes most impacts, using a liberally high estimate of the temperature of the copper electrode which determines the temperature of the gas, I find that the maximum number N' of molecules impinging per second during the interval would be $< 7.0 \times 10^{13}$. The number of electrons emitted per second would be $N_2 = 3.13 \times 10^{17}$. The ratio N_2/N' is thus $> 4.47 \times 10^3$. If the putative hydrogen atoms simply turned into a cloud of electrons whose total mass was equal to that of the hydrogen, the value of N_2/N' would be only 3.68×10^3 . The data already referred to for the tube with the filament 8 cm. long give an even larger ratio for N_2/N' , namely 1.5×10^4 . Moreover, in some of the experiments the changes in gas pressure were much larger than those recorded above, but they were never accompanied by any change in the electronic emission: also the admission of mercury vapour at its pressure (about 0.001 mm.) at room temperature produces no appreciable change in the emission. Thus there is no room for the idea that the emission of electrons has anything to do with the impact of gas molecules under the conditions of these experiments.

(3) The emission is a result of some process involving consumption of the tungsten.

To test this question some of the lamps were sealed off after being exhausted in the manner described. The filaments were then heated so as to give a constant thermionic current which was allowed to flow for long intervals of time. In this way the total quantity of negative electricity emitted by the filament was determined. The wire was placed in one arm of a Wheatstone's bridge so that the resistance could be recorded simultaneously. The cold resistance was also checked up from time to time.

At these high temperatures the resistance of the filaments increases slowly but continuously. This increase is believed to be due to evaporation of the tungsten. It was found to be proportional to the time of heating when the thermionic current was kept constant, in the case of any particular filament. In the case of one filament which gave 0.05 amp. for 12 hours, the increase in the resistance of the hot filament was 9 per cent. The accompanying proportionate increase in the cold resistance was slightly lower, namely 7 per cent. The latter may probably be taken as a fair measure of the amount of tungsten lost by the filament. The increase in resistance of the hot filament, which is less favourable for our

case, will be considered instead in the following experiment for which the other data are lacking.

A filament 3 cm. long gave 0.099 amp. electronic emission continuously for 2.5 hours. The resistance when hot rose from 4773 to 4787 in arbitrary units. The number of atoms of tungsten lost by the filament in this time was $= 5.66 \times 10^{15}$ whilst the number of electrons emitted $= 5.57 \times 10^{21}$. The number of electrons emitted per atom of tungsten lost was 9.84×10^5 . The mass of the electrons emitted in this experiment was thus very close to *three times* the mass of the tungsten lost by the filament.

This tube gave 0.1 amp. electronic emission on the average for 6 hours altogether. By that time the mass of the electrons emitted was approximately 2 per cent. of the mass of the tungsten filament. The tube came to an end owing to an accident: the filament gradually became deformed until it touched the copper electrode and broke. The hardness of the tube was then tested with an induction-coil and the equivalent spark-gap was found to be 3.3 cm. The discharge through the tube gave a bright green fluorescence on the glass around the negative wire, but there was no indication of a glow or the faint purple haze which is obtained when traces of gas are present in tubes of this kind. There is thus no appreciable accumulation of gas even when the filaments are allowed to emit a large thermionic current continuously for a long time.

Another tube with a wire 2.7 cm. long giving 0.050 amp. lost 1.19×10^{17} atoms of tungsten in 12 hours as measured by the change in the cold resistance. The number of electrons emitted for each atom of tungsten lost was thus 1.13×10^5 , and the mass of the emitted electrons about one third of the mass of the tungsten lost. This tube ran altogether for about 23 hours giving various currents, and finally gave out owing to the local loss of material near one end caused by the sputtering or evaporation. Local over-heating is very apt to occur in these experiments as the thermionic leakage causes the heating current in the wire to be bigger at one end than the other. The mass of all the electrons emitted by this filament was equal to 4 per cent. of its total mass. Under a low-power microscope the filament did not appear to be much changed except in the region where it had burnt out, where it was much thinner than elsewhere.

There is no known reason for believing that the loss of tungsten is due to anything more profound than evaporation. But, in any event, the fact that the mass of the emitted

electrons can, under favourable circumstances, exceed that of the tungsten lost proves that the loss of tungsten is not the cause of the electronic emission.

(4) The only remaining process of a similar nature to those already considered which has not been discussed is the bare possibility that the emission is due to the interaction of the tungsten with some unknown condensable vapour which does not affect the McLeod gauge. This possibility is cut out by the fact that the thermionic emission is not affected when the liquid air and charcoal is cut off and the vapours allowed to accumulate in the tube, and by the fact that very considerable changes in the amount and nature of the gases present (as by the admission of mercury vapour) have no effect on the emission.

Taken together, these experiments prove that the emission of electrons does not arise from any interaction between the hot filament and surrounding gases or vapours, nor from any process involving consumption of the material of the filament. It thus follows that the emission of electrons from hot tungsten, which there is no reason for not regarding as exhibiting this phenomenon in a typical form, is not a chemical but a physical process. This conclusion does not exclude the possibility that, under other circumstances, electrons may be emitted from metals under the influence of various chemical reagents—a phenomenon which would be expected to exhibit the same law of dependence upon temperature; but it does involve a denial of the thesis that this emission is invariably caused by processes involving changes of material composition.

The experiments also show that the electrons are not created either out of the tungsten or out of the surrounding gas. It follows that they flow into the tungsten from outside points of the circuit. The experiments therefore furnish a direct experimental proof of the electron theory of conduction in metals.

I wish to express my appreciation of the assistance I have received from Mr. K. K. Smith, Instructor in the Laboratory, in the preparation of the tubes and in carrying out some of the measurements. Mr. Smith and I are engaged in a more detailed quantitative study of the emission of electrons from tungsten, the results of which we hope shortly to publish. I also wish to thank Dr. W. R. Whitney and Dr. I. Langmuir, of the General Electric Company, both for supplying the specimens of ductile tungsten used and also for giving me the benefit of their invaluable experience.

Palmer Physical Laboratory,
Princeton, N.J.

XXIII. *On Electric Currents through Air Films.*

By Prof. A. ANDERSON*.

IN the Philosophical Magazine for May 1912 there is a short paper in which some experiments on electric currents in air at atmospheric pressure are referred to. Mr. H. N. Morrison, who is now working at the subject, has obtained further results, some of which, I venture to think, are of sufficient importance to be communicated before all of them can be presented in their final form.

Fig. 1.

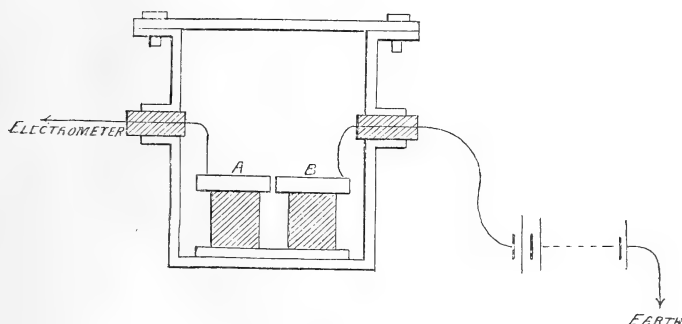

Two brass bars, A and B, fig. 1, with carefully worked plane ends each of area 1.15 sq. cm., are mounted firmly on paraffin blocks stuck on a copper plate, so as to include between them a rectangular film of air of a uniform thickness of about .002 cm. This apparatus is placed inside an earthed copper box which can be made nearly air-tight. Air, after having been passed through drying-tubes and tubes containing closely packed glass-wool, was passed slowly at intervals through this box for several days, and no air was afterwards admitted which had not been similarly treated. If B be connected to one of the poles of a battery of cells and A to one of the terminals of a quadrant electrometer, the electrometer will charge up and the current can be measured easily. If A and B are different metals and B earthed, the electrometer will also charge up, and at a surprisingly quick rate, the final deflexion giving the contact difference of potential. Indeed this is the easiest method of measuring contact differences, no special ionizing agent being necessary.

Currents between two brass bars as above described are

* Communicated by the Author.

produced by very small potential differences and increase with the applied voltage, for pressures up to about 80 volts, approximately according to Ohm's law, after which the increase of current is much more rapid than the increase of voltage.

The questions arise—why does a current pass? and what carries it? To say that there is metallic contact produced by the electrostatic pressure between the plates will not solve the difficulty, at any rate in the case where the metals are different and no potential applied. When the metals are the same and a potential applied, experiment shows that the current diminishes when the pressure of the air is diminished, and, if the pressure is not made too small, and the air in the copper box not kept at the low pressure too long, again increases as the pressure is increased, the current, however, for the same pressure being somewhat smaller when the pressure is being increased than when it is being decreased. This is shown in fig. 2 for an applied difference of potential

Fig. 2.

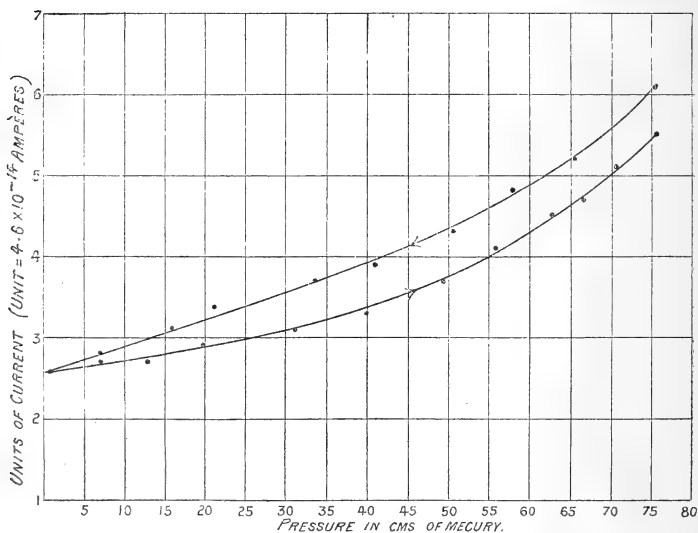

of 100 volts. Here the pressure was diminished to that equivalent to 8 millimetres of mercury.

This dependence of the current on the pressure of the air

seems inconsistent with an explanation based on the assumption of metallic contact.

Another possible explanation would be the presence of dust or ions in the air contained in the copper box. Every effort was made to free the air from dust, but, no doubt, some still remained. That the current is not due to dust seems to be proved by the following experiment. When the applied potential was 100 volts, the pressure was reduced to about 2 millimetres of mercury and kept at that for about 20 minutes, with the result that the current stopped completely, or was so small as not appreciably to affect the electrometer. The pressure was then increased very gradually by allowing air to go slowly through the drying apparatus and the glass-wool; and it was not until the pressure became nearly half an atmosphere that an appreciable current was observed. It then increased rapidly with increase of pressure, and finally, at atmospheric pressure, became nearly what it was before the box was exhausted. In all cases A and B were kept earthed unless when a measurement of current was being made, the measurement lasting for about half a minute.

If the conductivity were due to dust, there does not seem to be any reason why there should be such an enormous lag between the increase of pressure and the increase of potential.

If the conductivity were due to the presence of ions throughout the air in the copper box, it ought to be possible to diminish it by applying a high voltage to one of the bars so as to remove them. But if this is done the current afterwards becomes much greater, provided the high voltage is not applied too long.

Everything, therefore, points to the formation of ions in the surfaces of the film of air in contact with the ends of the bars, which become available as carriers when the opposing surfaces are close enough. These ions can be removed by removing the air; and when the air is introduced again they are again formed, but not instantaneously. Their formation requires time. It is probable that such layers of ions exist at the surfaces of all bodies in contact with the atmosphere, and that they play a prominent part in colierer action and in all cases of the discharge of bodies by contact.

XXIV. *Some Experiments with the Active Deposit of Thorium.*
 By E. MARSDEN, M.Sc., Lecturer in Physics, and R. H. WILSON, B.Sc., University of Manchester*.

IN a recent paper Darwin and one of us † suggested the following scheme for the transformations in the active deposit of thorium :—

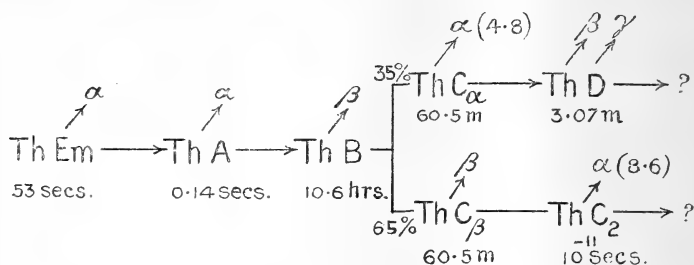

In this scheme C_α ‡ and C_β were presumed to denote the same substance thorium C breaking down in different ways, *i. e.* with the expulsion of an α or a β particle. Miss Meitner §, however, has obtained results which apparently show that the fraction of thorium C (*i. e.* C_α) which gives rise to the γ -ray product D can be isolated and separated from the rest of the products. In her experiments a hydrochloric acid solution of the active deposit, $B + C + D$, was taken, a few drops of stannous chloride added, and successive nickel plates immersed for twenty minutes. The solution was then divided into two portions which were boiled to dryness on watch-glasses, and the variation of activity observed by α and by γ rays, respectively, for the ensuing five hours. The results are shown in fig. 1, where the curve marked α gives the variation of the α -ray activity, and that marked γ the variation of the γ -ray activity. With no stannous chloride added, both the α - and the γ -ray curves rose together from the same small initial percentage of the maximum.

Since the γ rays all come from thorium D ||, which in consequence of its short period practically accompanies C_α in proportional amount, these results were interpreted by

* Communicated by Prof. E. Rutherford, F.R.S.

† Marsden & Darwin, Proc. Roy. Soc. A. lxxxvii. p. 17 (1912).

‡ As we are only dealing with the thorium products they will in this paper be simply denoted by A, B, &c. When C is mentioned it will be taken to signify $(C_\alpha + C_\beta + C_2)$.

§ Lise Meitner, Phys. Zeitschr. xiii. p. 623 (1912).

|| Except some soft γ rays from B (see later).

assuming that, in the presence of stannous chloride, the nickel plates remove the product C_a leaving B and C_β in solution. The initial α -ray activity would thus be due to C_2 ,

Fig. 1.

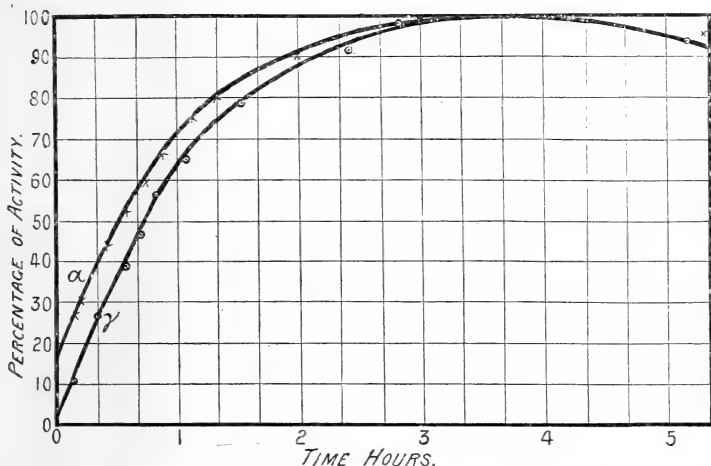

which is really part of C_β and has only been given the hypothetical period 10^{-11} second to conform to Geiger and Nuttall's law connecting the range of an α particle with the period of its products. The increase of activity would on this idea be due to the growth of C_a and D in both cases.

In the experiments cited above, however, Marsden and Darwin showed that if thorium C consists of two separate products their periods must be the same to within about 2 per cent. The point of view taken was that for thorium C there is a chance λ_a that an atom should disintegrate in any second and give an α particle and a separate chance λ_β that the same atom should disintegrate and emit a β particle. This would require $0.65 \lambda_a = 0.35 \lambda_\beta$ and $\lambda_a + \lambda_\beta = \lambda_c$; where λ_c is the ordinary transformation constant of thorium C calculated from the period 60.5 minutes. If C_a and C_β , or products corresponding to them, actually have an independent existence as Miss Meitner's experiment suggests, then it becomes of importance to ascertain the exact relation between their periods.

This was investigated as follows. A dilute hydrochloric acid solution of the active deposit was taken and a nickel plate dipped in for about one minute. In these circumstances the experiments of both Miss Meitner and

Marsden and Darwin agree that amounts of C_α and C_β are deposited on the plate in the same proportion as they exist in the active deposit as ordinarily collected. The ionizations due to the α particles of ranges 4.8 cm. and 8.6 cm. were balanced against one another, as shown in fig. 2.

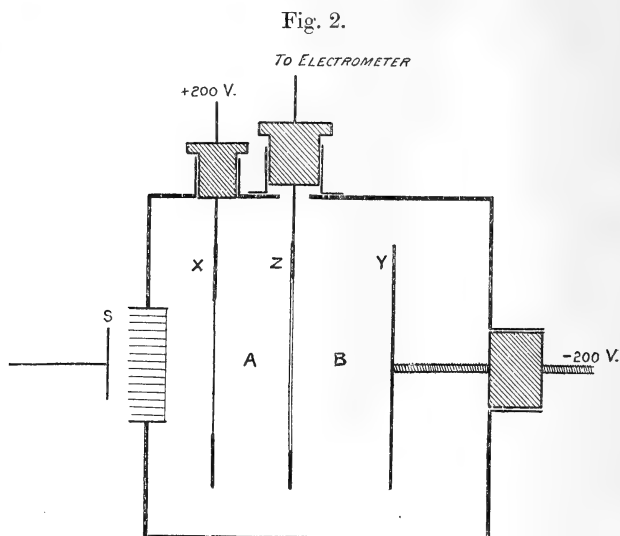

The α particles from the nickel plate S passed through a canalising grid into two ionization chambers A and B of depth 2.0 and 2.6 cm. respectively, the electrodes being rings covered with thin foils of aluminium equivalent to 0.5 mm. of air in stopping power of α particles. The α particles of range 4.8 cm. penetrated about 1.6 cm. into the first chamber, whilst those of range 8.6 cm. penetrated both chambers and struck the electrode Y about 0.7 cm. from the end of their range. X was charged to +200 volts and Y to -200 volts, whilst Z was connected to a Dolezalek electrometer. Balance was made as accurately as possible by the adjustment of S, Z, and Y.

In these circumstances it could be calculated that the ionization due to the α particles of range 4.8 cm. was just about 50 per cent. of the total ionization in the first chamber. It was hoped to detect any difference in the periods by a change in the balance as the source decayed. A typical set of readings is given in Table I.

The first observation was made about twenty minutes after the nickel plate was withdrawn from the solution, so that the thorium D was in equilibrium. Column I. gives the time

interval between succeeding observations and this first observation. Column II. gives the deflexion of the electrometer-needle per minute as deduced from observations at

TABLE I.

Interval since 1st observation.	Drift of electrometer needle. cm. scale divs./min.	Ionization in either chamber. cm. scale divs./min.	Percentage disturbance of balance.
0 hrs. 0·0 min.	-1·3	1400	-0·1
" 40·5 "	-0·3	870	-0·035
" 54·5 "	-0·1	740	-0·015
1 hr. 12 "	-0·3	600	-0·05
" 41 "	-0·2	430	-0·04
2 hrs. 5 "	-0·02	330	-0·01
3 " 58 "	-0·1	90	-0·12
5 " 0 "	-0·1	43	-0·23

intervals of one minute for five minutes. There were, of course, considerable probability fluctuations, but the mean position was taken in each case. Column III. gives the ionization in either chamber as deduced from the curve drawn through several observations as the decay proceeded. Column IV. gives the percentage disturbance of the balance. In these observations the barometric pressure and temperature were approximately constant during the experiment, otherwise a calculable correction would have been necessary owing to the alterations in the ranges of the α particles according to the density of the air.

It will be seen that the balance does not change by more than 0·3 per cent. in five hours. Therefore, since the α particles of range 4·8 cm. contribute half the ionization in the first chamber the ratio of the numbers of particles of the two ranges does not alter by more than 0·6 per cent.

Taking the period of either product, say I., as 60·5 mins., *i. e.* $\lambda_1 = 0·687$ hour⁻¹.

In 5 hours activity of I. falls to a fraction $e^{-5\lambda_1}$,

$$\begin{aligned} \therefore \text{ " } 5 \text{ " " II. " " " } & e^{-5\lambda_1} \times (1 \pm 006) \\ & = e^{-5\lambda_1} \cdot e^{\pm 006} \\ & = e^{-5(\lambda_1 \pm 0012)}. \end{aligned}$$

$$\therefore \lambda_2 = \lambda_1 \pm 0012,$$

$$\lambda_2 - \lambda_1 / \lambda_1 = \pm 0012 / 0·687 = 1/570,$$

i. e. the transformation constants are the same to within 1 part in 570.

This agreement between the periods, which was verified in several sets of observations, is very remarkable if C_α and C_β have an independent existence as different products, and is therefore strong evidence against that hypothesis.

Experiments were tried in which, before dipping in the nickel plate, a few drops of stannous chloride were added to the solution of the active deposit. Even in this case no change of balance with decay could be observed, and, moreover, keeping the electrodes in the same positions as before, the position of the source S for a balance was exactly the same. As the balance was very sensitive to changes in the position of S, this result shows that the proportion of the products on the nickel plate was exactly the same as when no stannous chloride was used.

Since this result is practically in direct opposition to the conclusion of Miss Meitner, a repetition of her experiments was undertaken. A hydrochloric acid solution of the active deposit was made, and, maintaining the temperature at about 90° C., seven successive well-polished nickel plates were immersed for a period of twenty minutes in all. In this way the C product was nearly all removed and the D allowed to decay. A drop of the solution was taken and evaporated on either a platinum foil or a watch-glass for observations by α rays, and the remainder was quickly boiled to dryness for observations by γ rays.

In the earlier experiments results were obtained exactly the same as those of Miss Meitner, *i. e.* the γ and α ray activities rose proportionately, while when stannous chloride was added the γ -ray activity rose from a lower initial percentage value than the α -ray activity (see fig. 1).

Further investigation has, however, led us to the conviction that the results are anomalous, and caused mainly by the fact that in presence of hydrochloric acid thorium C volatilizes at a comparatively low temperature. In the ordinary case of a plate exposed in air to thorium emanation, when presumably the products are present as oxides, B is volatile at 700° C.* and C at 1200° C. If a hydrochloric acid solution of the active deposit is taken and boiled to dryness on a watch-glass and heated gently for about one minute, we find from the subsequent variation in activity with time that about 30 per cent. of the C is removed and practically none of the B. With a nitric acid solution, however, even with strong heating neither product is volatilized. If the hydrochloric acid solution be taken, and

* Miss Slater, Phil. Mag. ix. p. 628 (1905).

stannous chloride, zinc chloride, or even ammonium chloride added, and the solution boiled to dryness and heated as before, then practically the whole of the C can be carried off by the fumes of the added salt. It would appear that the C is carried off by some sort of mechanical action rather than by its forming compounds of increased volatility. In these experiments the temperatures were not measured accurately, but probably the highest temperature was from 250° C. to 300° C. in each case.

It appears probable that in Miss Meitner's experiment with stannous chloride the nickel plates remove only about 80 per cent. of the C. When the resulting solution is heated the α -ray portion, which consists of only one drop, needs very little heating to boil it to dryness. The remainder, however, needs much more heating, due to its larger amount, and as volatilization is a time-effect, practically the whole of the remaining C is evaporated, so that the activity rises from zero. In the case when no stannous chloride is added, however, the nickel plates are more efficient in removing the C, due to there being no impurity present, and, moreover, if a small amount of C is left it is not so volatile as when stannous chloride is present to carry it away.

We made observations of "rise curves" (see fig. 1) without evaporating the γ -ray portion to dryness, and found that the α - and γ -ray activities rose proportionately. Further observations were made of the rise curves by α rays, (1) with the source uncovered, and (2) with the source covered with foils sufficiently thick to absorb the α particles of short range. When reduced to the same maximum the curves showed no difference, indicating that no true separation of the products emitting the two sets of α particles had taken place. In another experiment a hydrochloric acid solution of the active deposit was taken and divided into two portions, to one of which a few drops of stannous chloride were added. On completely evaporating to dryness it was found that much more C had been volatilized in the latter case than in the former.

In consideration of Miss Meitner's "rise curves" by α and γ rays, moreover (fig. 1), it must be remembered that the γ rays are emitted by D, which lags behind C, the origin of the α rays. This is shown by the theoretical curves for C and D, of which the initial parts are given in fig. 3, the scale being such that the ordinates are percentages of the maximum activity in each case. It will be seen that D apparently rises from 6 per cent. below C.

An increased initial difference between the curves arises

from the slow β rays of B, which are intensely ionizing. With stannous chloride present as impurity, a larger amount of B will be present for the same α -ray activity due to the absorption in the material.

Fig. 3.

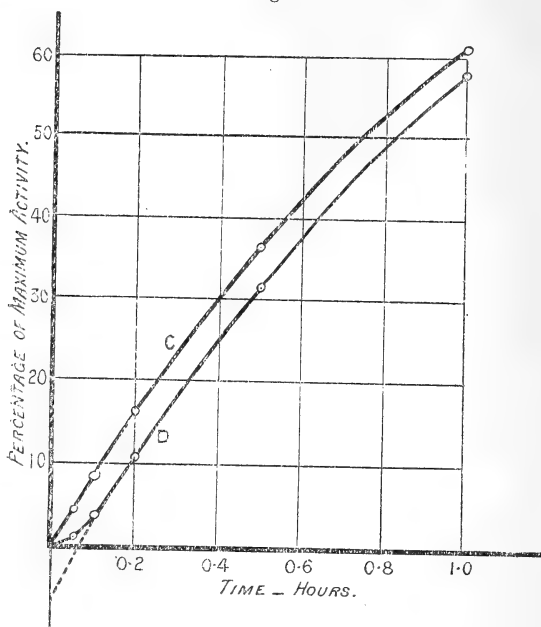

To throw further light on the possible separate existence of C_a and C_β , experiments were also made with β rays. The β rays of C_β have an absorption coefficient in aluminium of 13.5 cm.^{-1} and those of D 21.5 cm.^{-1} . Pure C was deposited on a nickel plate by immersion in a hot dilute hydrochloric acid solution of the active deposit. The rise curves by β rays due to the growth of D were determined, (1) when stannous chloride was added to the active deposit solution, and (2) with no stannous chloride. No difference could be detected. Further, after the D had attained equilibrium, *i. e.* about twenty minutes, the ratio of the β -ray activity through 0.015 cm. Al and 0.12 cm. Al was measured in each case and found to be the same. Owing to the different absorption of the β rays, this ratio would depend on the relative amounts of D and C_β present, and the result thus indicates no separation of C_β from the parent of D, *i. e.* C_a on the above scheme.

It is of course just possible that D does not really arise from C_α , but from C_β or both. This, however, hardly seems likely.

From the various experiments we therefore conclude that Miss Meitner's experiments do not furnish sufficient evidence as to the existence of two separate products of about the same period in thorium C, but that it is more probable that there are two methods of disintegration possible for the same atom.

γ Radiation from Thorium B.

In the above experiments on the growth of D from B by Miss Meitner's method, it was noticed that when the γ -ray rise curves were determined through 1.6 mm. and 7 mm. lead, a difference in the initial percentage activity (of the maximum in each case) of about 11 per cent. was observed, the curve in the former case being the higher. This shows that soft γ rays are emitted from B, and it will be noticed that they are very similar as regards penetrating power to the γ rays from radium B. On account of these soft γ rays all the measurements of γ rays made in the above experiments were made through at least 7 mm. lead.

Further experiments also showed that thorium C emits no appreciable quantity of γ rays which can penetrate 1.6 mm. lead. The properties of the various γ rays are, however, being investigated in more detail by Prof. Rutherford and Mr. Richardson in this laboratory.

In conclusion, therefore, the following scheme represents our present knowledge of the transformations in the active deposit of thorium :

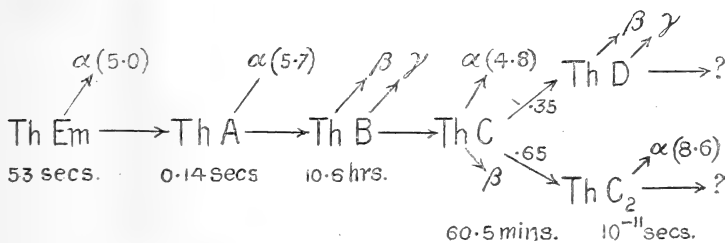

We are deeply indebted to Prof. Rutherford for his kind encouraging interest in these experiments.

XXV. *On Magneto-Optical Rotativity.* By G. H. LIVENS,
B.A., *Fellow of Jesus College, Cambridge**.

IN several recent communications to this Journal I have discussed and developed a modification of Drude's analysis of the electromagnetic theory of optics, which provides a good account of many hitherto unexplained phenomena, chiefly concerned with the effect of the nature of a substance on its optical behaviour. The subject discussed in the present paper provides further evidence in support of the theory there discussed.

It is a well-established fact that the magneto-optical behaviour of simple liquid mixtures is not simply additive, as the elementary form of Drude's theory would lead one to expect. The present theory leads to a much more complicated relation, which appears to be supported by the experimental evidence, at least as far as I can judge from the rather limited amount of information I have access to at the present moment. No new hypothesis is required to be added to the previous assumptions to obtain these new results, which follow directly from equations already deduced.

In the first paper of the series the general equations of motion of the typical electron oscillating in an external magnetic field were shown to be of a type

$$m\ddot{x} + h\dot{x} + kx - \frac{eH}{c}\dot{y} = e(E_x + aP_x),$$

$$m\ddot{y} + h\dot{y} + ky + \frac{eH}{c}\dot{x} = e(E_y + aP_y),$$

$$m\ddot{z} + h\dot{z} + kz = e(E_z + aP_z),$$

where the notation needs no explaining. We see at once that the vibration component parallel to the magnetic field is unaltered by the field, and is therefore merely modified in the manner previously described. It is, however, otherwise with the two components perpendicular to the magnetic field. In the previous paper the results of the analysis of these vibrations were given as far as they refer to the actual modification in the appearance of the spectrum lines. In the present paper it is proposed to investigate the rotation of the plane of polarization of a plane polarized beam of homogeneous light of frequency n propagated parallel to the lines of the applied magnetic field. In dealing with light

* Communicated by the Author.

of frequency n , the first two of the above equations reduce to

$$px - iqy = e(E_x + aP_x),$$

$$py + iqx = e(E_y + aP_y),$$

where

$$p = -mn^2 + ihn + k, \quad q = \frac{enH}{c},$$

whence we have

$$(p \mp iq)(x \pm iy) = e(E_x \pm iE_y) + ae(P_x \pm iP_y),$$

whence also since

$$\sum ex = P_x, \quad \sum ey = P_y,$$

we have

$$P_x \pm iP_y = \left(\sum \frac{e^2}{p \mp iq} \right) (E_x \pm iE_y) + \left(\sum \frac{ae^2}{p \mp iq} \right) (P_x \pm iP_y),$$

where the sums Σ are taken per unit volume over all the optically excitable electrons. From this relation we deduce in the usual manner that right- and left-handed circularly polarized beams are propagated with different velocities. The indices of refraction for the two beams are μ_+ and μ_- , where

$$\mu_{\pm}^2 = 1 + \frac{\sum \frac{e^2}{p \mp iq}}{1 - \sum \frac{ae^2}{p \mp iq}}.$$

The rate of rotation of the plane of polarization which arises from the interaction of these two circularly polarized beams is then determined by

$$\begin{aligned} \omega &= \frac{1}{2}n(\mu_- - \mu_+) \\ &= \frac{1}{2}n \frac{\mu_-^2 - \mu_+^2}{\mu_- + \mu_+}, \end{aligned}$$

and on account of the always small difference between μ_- and μ_+ this is practically

$$\omega = \frac{1}{4} \frac{n}{\mu} (\mu_-^2 - \mu_+^2),$$

where μ is the ordinary index of refraction of the substance. If now we use this result for a region of the spectrum where there is no absorption, the terms in h can be neglected, and

then $p = k - mn^2$ is real. Consequently we obtain, if we use $n_0^2 = \frac{k}{m}$

$$\mu_{\pm}^2 = 1 + \frac{\sum \frac{e^2}{m(n_0^2 - n^2) \mp q}}{1 - \sum \frac{ae^2}{m(n_0^2 - n^2) \mp q}}.$$

Now since q is always a comparatively small quantity, we can approximate to these values by expanding in powers of q . We then obtain

$$\begin{aligned} \omega &= \frac{qn}{2\mu} \times \frac{\sum \frac{e^2}{m^2(n_0^2 - n^2)^2}}{\left(1 - \sum \frac{ae^2}{m(n_0^2 - n^2)}\right)^2} \\ &= \frac{eHn^2}{2\mu c} \times \frac{\sum \frac{e^2}{m^2(n_0^2 - n^2)^2}}{\left(1 - \sum \frac{ae^2}{m(n_0^2 - n^2)}\right)^2}, \end{aligned}$$

and this is the formula which expresses the dependence of the rotation on the density of the active electrons. It is more complicated than that obtained from the elementary theory, to which, however, it reduces if we put $a=0$. This formula can be discussed in a manner exactly analogous to that in which we discussed in a previous paper the corresponding formula for the intrinsic optical activity, to which it is to a certain extent similar. Bearing in mind the results of our former discussion a few deductions are obvious.

In the case of solutions it would appear that a strict superposition of the rotations of solvent and solute can never take place. If we calculated the specific rotation of the dissolved substance from the elementary formula, it would vary with the concentration of the solution, the most common case being a decrease with increasing dilution. Moreover, the specific rotation calculated in this way might also depend on the solvent. All of these deductions have been verified by experiment.

An interesting application of the present theory is to the case of solutions of aniline dyes in alcohol, where there appeared to be some discrepancy in the results obtained. In his 'Optics' (ch. xviii. p. 502) Wood says, "the behaviour of alcoholic solutions of the aniline dyes in a magnetic field has been studied by Schmauss, who claimed that the effect of the dye was to increase the rotation of the alcohol on the

red side of the absorption band and decrease it on the violet side. If this is the case we should expect the solid dye to rotate the plane of polarization for waves on opposite sides of the absorption band in opposite directions. The author has, however, been unable to detect any trace whatever of rotary polarization in a film of cyanide so thick that nothing but red light was transmitted. Saturated solutions of cyanine between plates of very thin glass also showed no trace of the phenomenon, and it seems probable that the results obtained by Schmauss were due to experimental error."

It can, however, now be shown that Wood's deduction from Schmauss's result is not necessarily valid, and that the experimental facts are all consistent. Wood's investigation with pure cyanine proves that there is no appreciable rotation due to that substance in solution, but we have still to consider the effect of the added substance on the rotation of the alcohol. A modification of the rotation due to this cause is clearly indicated by our formula, and is of precisely the same kind as that found by Schmauss. Supposing, for simplicity, that the added cyanide is optically effectively equivalent to a set of N -electrons per unit volume with a proper frequency $n=n_0$, then the rotation of the light of frequency n would be modified from

$$\frac{\omega}{(1-aA)^2}$$

to

$$\frac{\omega}{\left(1-aA-\frac{\alpha N e^2}{m(n_0^2-n^2)}\right)^2},$$

where ω is the rotation of the alcohol represented by the usual simpler form of Drude's theory, and the index of refraction of pure alcohol is given by

$$\mu^2=1+\frac{A}{1-aA}.$$

This shows that by the addition of the cyanine the ω is increased when $n < n_0$ and decreased when $n > n_0$, as in Schmauss's experiments.

While on this point it is interesting to notice how the rotation is intimately connected with the refractive index of the medium, a fact first pointed out by Becquerel. The formula deduced to express this relation does not appear to be exact when the influence of the surrounding medium is

allowed for. The present theory shows that

$$\omega = \frac{Cn}{[1 + a(\mu^2 - 1)]^4} \frac{d\mu}{dn},$$

a relation which of course reduces to Becquerel's formula if $a = 0$.

It might also be mentioned that Disch* has concluded from the results of some experiments conducted with a few solutions, that the course of the magnetic rotatory dispersion as the frequency of the light varies is similar to that of the natural rotatory dispersion. This result is confirmed by the present theory, although Disch's deduction that the two are actually proportional does not appear to be exact.

The present simple theory has of course limits to its applicability. For example, it only admits of a rotation in a definite sense with respect to the lines of force in the magnetic field. But, as in the case with solutions of iron salts, it is found that changes in concentration may produce reversal in the direction of rotation, and even quite neutral solutions of active salts may be obtained. The extension of the present theory to include cases of this kind is, however, fairly obvious, and will be fully discussed in a future communication.

XXVI. *On the Constitution of the Mercury Green Line*

($\lambda = 5461 \text{ \AA.U.}$). By FREDERICK F. S. BRYSON, *M.A., B.Sc., Carnegie Scholar*, and JOHN LOGIE, *M.A., B.Sc., Eglinton Fellow, the University of Glasgow*. Communicated with an Introductory Note by Professor A. GRAY, *F.R.S.*

NOTE by Professor GRAY (March 25, 1913).—In a paper (Proc. R. S. lxxii. May 14, 1903) by Dr. Walter Stewart and myself (with Messrs. R. A. Houstoun and D. B. McQuistar) it was pointed out with regard to the green line of mercury, of wave-length 5461 tenth-metres, "that what appeared in an ordinary spectroscope as a single bright line was in fact a group of six or seven, consisting of one bright line with a triplet of faint satellites on the side next the violet end of the spectrum, and a triplet or at least a doublet of faint lines on the other side. These faint lines were very difficult to observe and to determine, and the measurements of wave-lengths which we obtained do not agree with those supplied to Zeeman by MM. Fabry and Perot. The lines, however, we found were only visible in our tubes when the discharge had been kept going for a long time, and when,

* *Ann. d. Phys.* xii. p. 1153 (1903).

therefore, the vacuum had been considerably changed ; and from glimpses that were obtained at times of what seemed to be further lines, it appears probable that the full complexity of the green line, when unaffected by a magnetic field, has not yet been disclosed, and can only be investigated under peculiar conditions of the vacuum in the tube, and possibly of the action of the discharging coil.”

Since that time the constitution of the green line of mercury has engaged the attention of several observers, and some account of their results is contained in the paper now communicated. It remains, however, still uncertain what are the conditions which govern the appearance of satellites in the absence of an impressed magnetic field. Sometimes these satellites are apparently absent or are only seen with great difficulty ; at other times, according to the observations referred to in the above quotation (observations which I made repeatedly) they flash out brightly but transiently in abnormal complexity. There can be no question of the importance of research into the governing conditions of such complexity of what have come to be regarded as comparatively simple systems.

It does not seem impossible that some of the discrepancies among the estimations of wave-lengths of satellites may be due to differences in conditions of production. I have been for a considerable time engaged in a research on these conditions, but so far it has proved difficult and perplexing. Now, however, with a ready means of constructing my own tubes, I have some hopes of obtaining a solution of the problem.

The paper now offered describes determinations of satellite wave-lengths which have been made during the last year in the course of this research. They are of interest in themselves ; and it is, moreover, desirable to place on record as many careful measurements of these lines as possible. The results have an interesting bearing on those which have been published recently by McLennan, Nagaoka and others, and which are referred to in the Comparative Table of Wave-lengths given at the end of the paper.

MANY observers have studied the mercury green line with different apparatus and using various sources, and there has been not a little lack of agreement as to its constitution. The experiments here described were undertaken to ascertain the reason for these divergencies by observing the appearance under varying conditions.

Apparatus.—The spectroscopic apparatus used in the first

place was a concave grating of 10 ft. radius of curvature, ruled by the late Lord Blythswood. It was hoped that the grating would prove powerful enough to analyse the line and that the results would be of the more interest, as most of the previous work has been done with echelon spectroscopes or Lummer plates. Also the simplicity of the interpretation of results which a grating secures made its use desirable. The grating was mounted in a manner advocated by Eagle * as being specially suitable for work of this nature, giving great steadiness, and constancy of temperature. Unfortunately it was found that the apparatus had not sufficient resolving power to give clear and reliable results. The ruled surface of the grating is $2\frac{3}{4}$ ins. by 2 ins., which is much smaller than that of the grating used by Gale and Lemon † in their work on the analysis of the mercury lines.

An echelon spectroscope of 26 plates, each 9.73 mm. thick, was then employed. The constants of this echelon are given in a paper contributed to the Royal Society by Professor Gray and Dr. Stewart‡. The green line in the spectrum was isolated in certain cases by using a Hilger constant deviation spectroscope, and at other times by means of a large prism placed between the echelon and the telescope or camera.

Sources.—Three sources of light were employed:—(1) A barometric U-tube, of Jena glass, with the arc across the vacuum. This had the advantage that the vapour tension could be easily determined from the height of the mercury column, and the length of arc could be increased or diminished by raising or lowering the reservoir connected to one end of the U-tube. Into the other closed end was sealed a platinum electrode. We found that after a few weeks' use the variations of temperature caused the glass to crack at the point where the electrode was sealed through, causing a leak and thus spoiling the vacuum. This form of lamp was ultimately discarded. (2) A small exhausted arc lamp, with an automatic starter, devised by Anderson and Burnside, and described in a communication recently made to the Royal Society of Edinburgh§. This lamp was used fairly extensively and gave very good results. (3) A Commercial Cooper Hewitt 27-inch lamp. This, though of greater candle-power, was of no higher intrinsic brilliance than the small lamp.

* *Astrophys. Journal*, xxxi. p. 120 (1910).

† *Ibid.* xxxi. p. 78.

‡ *Proc. Roy. Soc.* lxxii. No. 477, p. 16 (1903).

§ *Proc. Roy. Soc. Edin.* vol. xxxiii. pt. 1, p. 117 (1913).

Results.—When the small arc lamp was used, visual observations of the line showed the characteristic pattern—one bright centre line, two not far apart on the left (the side of greater wave-length), a closer doublet on the right, and an isolated line further off to the right, almost centrally placed between the two successive spectra. These lines have the same positions relatively to the centre line as the satellites numbered respectively (5), (6), (4), (3), (1), in the appended table. As no variation of current strength or lamp temperature seemed to affect this visible pattern, photographic methods were afterwards adopted.

In the small lamp a current of somewhat less than one ampere was used, and the vapour pressure could not exceed 50 mm. of mercury and was usually about 40 mm. The temperature of the lamp was about 230° C. With the Cooper Hewitt lamp currents varying from 2 amps. to 3·7 amps. were used, giving a variation of temperature from 130° C. to 400° C., and consequently of vapour pressure from 1·2 mm. of mercury to about 1500 mm. Photographs were taken at various points along the length of the tube from about 5 cm. from the anode to about 5 cm. from the cathode. With all the lamps only “side on” exposures were obtainable. The self-induction of the circuit was not varied.

Notwithstanding these variations in the conditions of the lamps and in the type and size of lamp, there was absolutely no measurable change in the line pattern. Photography revealed three fainter satellites not visible to the eye, and obtained on about 70 per cent. of the plates measured. These faint satellites are nos. (2), (7), and (8) in the following list. The results of measurements give the values as shown in the second last column of Table I., for the positions of the satellites. These are average results; but the agreement of the measurements from different photographs was very close, the “probable error” of the measurements being ·001 A.U., *i. e.* fifty per cent. of the measurements do not differ from these means by more than ·001 Å. U. Our plates show four satellites on each side of the main line. We could detect no evidence of the centre line itself being complex. All our measurements are taken from the middle of this main line.

Comparison with Previous Results.—In Table I. we give also the results obtained by other observers for the positions and relative intensities of the satellites. Fig. 1 shows diagrammatically the various patterns observed, the lengths of the lines being drawn proportional to the intensities.

TABLE I.

Crossed Plates.		Grating.		Echelon crossed with plate.		Echelon spectroscopie.					Reference Number.									
Gehreke and v. Baeyer*.	v. Baeyer†.	Gale and Lemon†.	Nagaoka and Takamine‡.	Janicki§.	Fürst Galitzin¶.	Stansfield**.	Lunelund††.	McLennan‡‡.	Bryson and Logie.											
-.241	2	-.237	2	-.233	1	-.242	5.22	-.232	$\frac{1}{2}$	-.236	4	-.243	5	-.245	5	-.243	6	1		
—	—	—	—	—	—	—	—	—	—	—	—	—	-.215	1	-.215	1	—	2	2	
—	—	—	—	—	—	—	—	—	—	—	—	—	-.191	1	-.191	1	—	—	—	
—	—	—	—	—	—	—	—	—	—	—	—	—	-.169	1	-.169	1	—	—	—	
-.111	5	-.101	4	-.094	3	-.108	2.62	-.099	$\frac{1}{6}$	-.099	3	-.108	3	-.141	1	-.141	1	—	—	
-.066	4	-.068	3	-.054	3	-.074	4.92	-.066	$\frac{1}{2}$	-.068	6	-.079	4	-.110	3	-.110	3	-.102	3	3
—	—	-.049	5	—	—	-.054	1.50	-.047	$\frac{1}{2}$	-.047	2	-.079	4	-.070	2	-.070	2	-.067	4	4
000	10	-.024	1	000	10	-.026	8.26	000	1	000	10	-.026	8	—	—	—	—	—	—	—
+.087	1	+.082	1	+.083	2	+.078	5.77	+.088	$\frac{1}{2}$	+.085	5	+.076	6	+.090	6	+.073	6	+.083	7	Main
+.131	3	+.125	3	+.130	3	+.123	3.47	+.133	$\frac{5}{8}$	+.129	1	+.120	4	+.135	4	+.118	4	+.128	5	Line.
—	—	—	—	—	—	—	—	—	—	—	—	—	—	—	—	+.158	1	+.174	1	5
—	—	+.211	6	+.217	4	+.210	1.34	—	—	—	—	+.205	2	+.210	2	+.205	2	+.212	1	6
—	—	—	—	—	—	—	—	—	—	—	—	—	—	—	—	—	—	—	—	7
—	—	—	—	—	—	—	—	—	—	—	—	—	—	—	—	—	—	—	—	8

* Gehreke and v. Baeyer, *Ann. der Phys.*, xx, p. 269 (1906).
 † O. v. Baeyer, *Phys. Zeit.*, ix, p. 831 (1908).

‡ Gale and Lemon, *Astrophys. Journ.*, xxxi, p. 78 (1910).

§ Nagaoka and Takamine, "Proceedings," Phys. Society, xxv, pt. 1 (Dec. 15, 1912).

|| Janicki, *Ann. der Physik*, xix, p. 36 (1906).

¶ Fürst Galitzin, *Bull. de l'Acad. Impériale des Sc. de St. Pétersbourg*, p. 159 (1907).

** Stansfield, *Phil. Mag.* (6) xviii, p. 371 (1909).

†† Lunelund, *Ann. der Phys.*, xxxiv, p. 505 (1911).

‡‡ McLennan, *Proc. Roy. Soc. Lxxxvii. A.* 595, p. 269 (1912).

It will be seen that the values for the positions of our satellites, with the exceptions of nos. (2) and (7), as given in Table I., agree best with those of the other investigators who have not had the main line resolved.

Fig. 1.

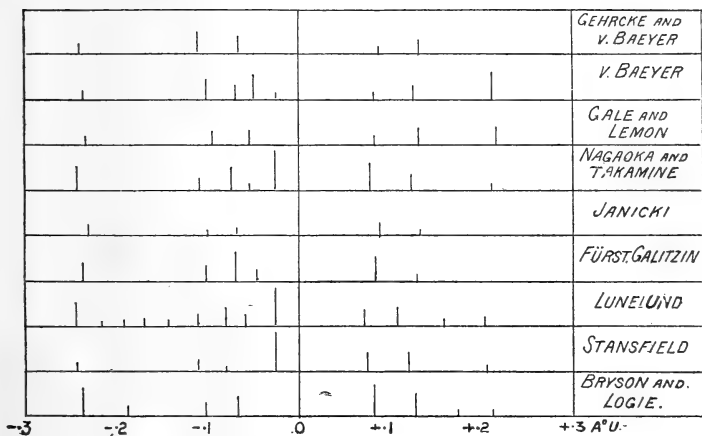

Stansfield and Nagaoka and Takamine have taken their measurements from the satellite of shortest wave-length as being a good reference line. Table II. (p. 372) gives the distances of the satellites from this line.

The table shows that the greatest discrepancies occur in the case of the central line. The values for the other components are in fairly good agreement, although McLennan's values seem too high throughout. It will be noticed, however, that the relative brightnesses vary greatly. Our component no. (2) at -0.187 was clear and well defined, while no. (7) at $+0.174$ was faint but fairly well defined. The existence of these lines was verified by the methods suggested by Stansfield *, and we are confident that they are both real. If measured from the position of Nagaoka and Takamine's brightest component of the resolved main line, their positions would be respectively -0.200 \AA. U. and $+0.161 \text{ \AA. U.}$ It may be noted that for -0.200 , the value of $\frac{d\lambda}{\lambda}$ is $-122 \times 3 \times 10^{-7}$, while for $+0.161$, $\frac{d\lambda}{\lambda}$ is $98 \times 3 \times 10^{-7}$; both of which values fit well into the table given by Nagaoka and Takamine † of the values of $\frac{d\lambda}{\lambda}$ for various satellites of different lines.

* *Loc. cit.*

† *Loc. cit.* p. 26.

TABLE II.

Gehrke and v. Baeyer.	v. Baeyer.	Gale and Lennon.	Nagoka and Takamine.	Janicki.	Galitzin.	Stansfield.	Lunelund.	McLennan.	Bryson and Logie.	Reference Number.
.000	.000	.000	.000	.000	.000	.000	.000	.000	.000	1
—	—	—	—	—	—	—	.030	—	—	2
—	—	—	—	—	—	—	.054	—	.018	
—	—	—	—	—	—	—	.076	—	—	3
—	—	—	—	—	—	—	.104	—	—	
.130	.136	.139	.134	.133	.137	.135	.135	.139	.133	4
.175	.169	.179	.168	.166	.168	.164	.166	.173	.168	
—	.188	—	.188	—	.189	—	.187	—	—	Main line.
.241	.213	.233	.216	.232	.236	.217	.219	.243	.235	
—	.237	—	.242	—	—	.243	.245	—	—	5
.328	.319	.316	.320	.320	.321	.319	.318	.333	.318	
.375	.362	.363	.365	.365	.365	.363	.363	.378	.363	6
—	—	—	—	—	—	—	.403	—	.409	7
—	.448	.450	.452	—	—	.448	.450	.453	.447	8

We add a diagram (fig. 2) of the spectrum of the line showing the relative widths of the components.

Fig. 2.



With the lamps used we found no change in the pattern after the lamps had been running for even six hours on end.

Various kinds of photographic plates were tried. The best results were obtained from "Imperial Orthochrome, Special Sensitive." The exposures varied from twenty to eighty minutes, and the plates were all developed under the same conditions.

Conclusions.—It would appear from these investigations that the discrepancies in the positions of these satellites as determined by different observers are for the most part apparent, not real, and are dependent upon the difficulty of judging the centre of the main wide line. See Table II.

Janicki and Galitzin and Wilip observed that a change of pattern occurred when the lamp reached a high temperature. Accounts of this phenomenon have also been given by Stansfield and by McLennan, who do not state what temperature was attained. Within the range of temperature employed by us no such effect was observed.

The discrepancies in the relative brightnesses of corresponding satellites in the different cases appear not to be due to any variations of temperature or of vapour pressure, and as they cannot well be attributed to absorption they remain at present unexplained.

We desire to thank Professor Gray for the advice he has given us, and for the interest he has taken in these experiments.

NOTE.

Since writing the above we have made further experiments with a view to studying the change of pattern observed by Janicki and by Galitzin and Wilip. In order to observe the effect under conditions similar to those under which it was first obtained, we employed vacuum-tubes filled and exhausted by ourselves and driven by a large

induction-coil. The tubes were exhausted by a Fleuss two-cylinder pump, and were in open connexion with a P_2O_5 drying-tube. On heating the tube slightly the effect was soon obtained. The discharge in the tube became very brilliant and very broad and continuous, suggesting a breakdown of the insulating properties of the vacuum, while the appearance in the echelon exactly corresponded to Janicki's description of "five equidistant bands." With the arc, as described above, we were unable to obtain this effect. The cases differ in three respects: (1) temperature, (2) perfection of vacuum, (3) nature of discharge.

(1) We have measured the temperature at which the effect was obtained, and find it varies from $200^\circ C.$ to $260^\circ C.$ or more, depending apparently upon the degree of vacuum. The temperatures attained by the arc varied as stated above from $130^\circ C.$ to over $400^\circ C.$ Hence the effect is not due solely to temperature.

(2) We find that the effect is more easily obtained with an imperfectly exhausted tube, though we could always obtain it with the highest vacua that our pump could give.

(3) The nature of the discharge seems to have some slight effect. When the hammer of the coil was working unsteadily, the appearance would flicker in and out even at temperatures below $200^\circ C.$, while when the proper conditions had been attained it worked smoothly.

We have succeeded in obtaining photographs of the effect, and from these the measurements have been taken. Owing to the great width of the bright lines it was not easy to judge their centres, and we do not claim an accuracy of more than $\cdot 005 \text{ \AA.U.}$ The whole appearance so strongly suggested an inversion due to absorption, that we have also measured the distances between the dark lines to compare with the normal pattern given above.

Bright lines ...	—·206	—·103	—·059	·000	·089	·177
Dark lines ...	—·234	—·124	—·051	·000	·075	·163
Normal pattern	—·235	—·187	—·102	—·067	·000	·083 ·128 ·174 ·212

The line at $—\cdot 059$ is very faint and only obtained on some of the photographs. The one at $\cdot 177$ is very broad and may be two lines or rather bands with a dark line between. The correspondence of patterns is better shown by a diagram in which the relative brightness of the lines is shown.

By omitting the faint band at $—\cdot 059$ Janicki's system of five "equidistant" bands is obtained. We consider that

these measurements and diagrams indicate that the effect is due to absorption, and is caused primarily by foreign vapours

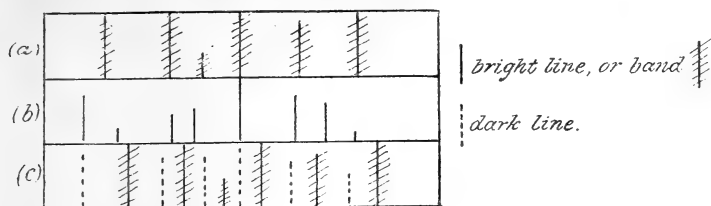

- (a) Janicki effect, brightest central line made to correspond with main line in normal pattern (b). The 5 brightest lines in (a) do not correspond well with those of (b).
 (c) Janicki effect, central dark line made to correspond with main line of (b). The six best defined dark lines of (c) correspond fairly well with the six brightest of (b).

in the tube either left behind in exhausting or obtained from the aluminium electrodes, or the P_2O_5 tube, temperature and discharge being secondary factors.

F. F. S. BRYSON.
 J. LOGIE.

XXVII. *Remarks on the Note of Mr. W. A. Douglas Rudge: "On the Electrification of the Atmosphere and Surface of the Earth."*

To the Editors of the Philosophical Magazine.

GENTLEMEN,—

MR. W. A. DOUGLAS RUDGE, Professor of Physics, University College, Bloemfontein, publishes in the *Philosophical Magazine* (vol. xxiii. p. 137, 1912) a note which, if remaining uncontradicted, might perhaps cause the erroneous opinion, that there is any abnormality in South Africa as to the electrification of the surface of the Earth. Mr. Rudge affirms that, with respect to South Africa, the opinion is false that the surface of the earth generally possesses a negative charge. He believes to have found an experiment by which he can easily prove a positive charge of the surface of the earth. The method of proving this is as follows: A long rod of wood is balanced upon a pivot. The left shorter arm is counterpoised by a weight. The rod is balanced in every position. The right arm has a well-isolated aluminium plate about $\frac{1}{8}$ sq. metre in area. From this plate a wire is taken to an electroscope. If the longer end of the rod is raised to a height of about 4 metres above the earth, the leaves of the

electroscope diverge from each other and show a positive charge.

It is apparent that this experiment must be explained as follows :—The conducting system composed of the aluminium plate, the wire and the electroscope, by making contact with the earth, is distributed in such a manner that the uttermost parts of it are charged : the plate with negative electricity, and the electroscope with positive electricity. The fact that the leaves of the electroscope show a positive charge therefore proves that the surface of the earth has a negative charge. The negative charge of the plate can be directly shown if, after being isolated from the earth, it is conveyed to a room protected from the earth, and examined there as to its electrical condition.

I am, Gentlemen,

Technische Hochschule,
Braunschweig.

Yours faithfully,
Dr. KARL BERGWITZ.

XXVIII. *Proceedings of Learned Societies.*

GEOLOGICAL SOCIETY.

[Continued from vol. xxv. p. 756.]

May 7th, 1913.—Dr. Aubrey Strahan, F.R.S., President ; and afterwards W. Whitaker, B.A., F.R.S., F.G.S., in the Chair.

THE following communications were read :—

1. 'The Bathonian Rocks of the Oxford District.' By M. Odling, M.A., B.Sc., F.G.S.

In this paper the author describes the lithology, palæontology, and stratigraphy of the Bathonian rocks north of Oxford, from the evidence afforded by numerous quarries and well-borings and by the Ardley Cutting on the Great Western Railway (new Birmingham main line).

The general sequence is as follows :—

		<i>Thickness in feet.</i>
CORNBASH.	Rubby non-oolitic limestone, with occasional marl-bands	8 to 17
	Slight unconformity.	
FOREST MARBLE.	Coarse shelly and oolitic limestones largely false-bedded. When traced eastwards the limestones are largely replaced by marls ; and finally the series is represented by green and blue clays with minor bands of limestone.	21
	Well-marked unconformity.	
GREAT OOLITE.		
	Block 1.	
	Compact, fine-grained, pure limestones, with a local blue or green clay about the centre. The variation in thickness is largely due to erosion.	7 to 13
	Well-marked eroded surface.	

Block 2.	Thickness in feet.
Compact limestones of a coarser texture than those of Block 1. The full thickness is exposed only in the Ardley Cutting, where it is 15 feet. The thickness to the base of the 'Nerinea Rock' is about 6 feet at Ardley and 17 feet in the Gibraltar Quarry, 3 miles away to the south-west.	}
Block 3.	
Clays and sandy argillaceous limestones, now exposed only in the Ardley Cutting.	} 7½

FULLONIAN.

Upper Beds.

Compact rock and clay, very fossiliferous.	5
Fullers' Earth Rock	4
'Concinna Beds'	4½

(Position of the Stonesfield Slates.)

Lower Beds.

'Næran Beds,' consisting of a series of semi-estuarine green clays, with one band of limestone about the centre.	} about 16
Chipping-Norton Limestone, consisting of sandy and argillaceous limestones.	} 12

After a general description of the series, the principal points of interest in the different sections and their mutual relations are described; and the author points out that, although no definite zones can be formulated, the different horizons are readily recognizable by their assemblage of fossils.

The chemical and microscopic structure of the rocks is dealt with, and the conditions of deposition and stratigraphical relationship of the different members of the series are discussed. In addition, some peculiar structures from the Chipping-Norton Limestone are described, and the author adduces his reasons for considering them to be annelid-tubes.

A complete list of the fossils is appended, showing the horizons and exposures from which they have been obtained; tables giving the correlation between different exposures are also added.

2. 'On the Petrology of the Kalgoorlie Goldfield (Western Australia).' By James Allan Thomson, M.A., D.Sc., F.G.S.

The district described comprises an area about 4 miles long by 1 mile in breadth. Towards its southern end the auriferous lodes are very rich (The Golden Mile), but in the northern end they are not so productive. The information as to the geological structure has mostly been obtained from mining plans, shafts, and workings. The rocks have a general north-north-westerly strike, and most of the junctions are faulted. In 'The Golden Mile' the central feature is a boss or broad dyke of quartz-dolerite, which forms a prominent ridge flanked by amphibolites and greenstones. The quartz-dolerite is cut by dykes of albite-porphry, and west of the main ridge similar porphyries are frequent. Gold is found principally in shear-

zones, impregnated with sulphides and tellurides, and is most abundant in the lodes in the quartz-dolerite.

The rocks for purposes of description are divided into

(A) *Sedimentary*.—Of these the most distinctive are conglomerates and grits, the former containing pebbles of quartzite and of albite-porphry.

(B) *Igneous*.—These are often very highly altered by metamorphism (inducing schistosity and partial recrystallization) and by metasomatic action. They include:

- (1) Fine-grained amphibolites; altered basic igneous rocks—probably lavas and tuffs.
- (2) Fine-grained greenstones; slightly schistose aggregates, probably related to the fine-grained amphibolites in origin.
- (3) 'Calc-schists': whitish-green rocks, which are closely connected with the greenstones and merge into them.
- (4) Peridotites, serpentines, etc., often filled with carbonates, but perhaps comprising originally enstatite-peridotites as well as other types. These rocks form the eastern part of the northern end, and include talc-magnesite rocks and fuchsite-magnesite rocks.
- (5) Hornblende-rocks or pyroxene-amphibolites, probably occurring as dykes in the peridotites.
- (6) Lustre-mottled amphibolites, containing remains of feldspar, and originally hornblende-dolerites.
- (7) Epidiorites, uralitized and saussuritized gabbros or ophitic dolerites, not very numerous.
- (8) Quartz-dolerites and their derivatives—amphibolites usually coarse-grained, with a considerable amount of interstitial micropegmatite. This is the important rock of 'The Golden Mile.' It contains very coarse pegmatitic veins, and is often to a great extent albitized. It presents a great variety of types due to different stages and kinds of alteration, and many of these phases are difficult to recognize as derived from the quartz-dolerites.
- (9) Albite-porphyrates (with hornblende and biotite) and albite-porphyrates. Secondary minerals are common in the rocks of this group.
- (10) Jaspers and graphitic schists. These traverse all the other rocks, occurring as lodes or bands, and may closely resemble sedimentary schists. They sometimes are found running on each side of dykes of albite-porphry. Their mode of origin is not quite certain, but they are intimately connected with the igneous rocks.

The relation and the sequence of the rocks of Kalgoorlie are next discussed.

The greenstones, fine amphibolites, and calc-schists are regarded as the old 'country-rocks,' into which the others are intrusive. They are probably a complex of basic lavas, ashes, etc. greatly altered.

The quartz-dolerites, hornblende-dolerites, and pyroxenites are very closely related one to the other, and show every grade of transition. Probably the peridotite group is merely the early basic facies of the quartz-dolerite series, and the porphyries and porphyrites, which were the last rocks intruded, are regarded as being derived from the same magma.

The metasomatic changes and origin of the ores are then considered. The great characteristic of this goldfield is the prevalence of albitization in the auriferous districts. From this, and from a general consideration of the rock-facies developed from the magma, it seems probable that we have in Kalgoorlie an instance of the production of auriferous lodes by rocks belonging to the same class as the pillow-lavas and their diabases and soda-granite-porphyrates (the siltitic suite of igneous rocks).

The paper contains a large number of chemical analyses, principally carried out by the chemists of the Geological Survey of Western Australia. By the kindness of the Director of that Survey the author has also been able to make use of the specimens in the Survey cabinets, in addition to those collected during his own examination of the goldfield.

May 28th.—Dr. Aubrey Strahan, F.R.S., President,
in the Chair.

The following communications were read:—

1. 'On the Age of the Suffolk Valleys; with Notes on the Buried Channels of Drift.' By Percy G. H. Boswell, B.Sc., F.G.S.

The main watershed of Suffolk follows generally the Chalk Escarpment, but keeps rather to the east of it, running in a north-easterly direction from Haverhill in the extreme south-west of the county. Suffolk forms a plateau, 100 to 400 feet O.D., dissected by a valley-system which is palmate in form, the chief rivers, taken from north to south, being the Waveney, the Alde, the Deben, the Gipping (with its estuary, the Orwell), the Brett, and the Stour. The Little Ouse and the Lark flow north-westwards into the Wash basin.

The strata (Chalk, Lower London Tertiaries, London Clay, Crags, etc.) cut through by the valleys, and the mantle of Glacial deposits (sands, gravels, and loams, Upper Boulder Clay, and morainic gravels) which more or less covers the whole county, are described briefly. Reasons are given for thinking that the Contorted Drift does not extend far south of the Waveney. The valleys, although they may have been etched earlier, are on direct evidence post-Pliocene in age; but, by analogy with the Waveney and the Norfolk rivers, they may be younger than the Contorted Drift.

The Upper Boulder Clay (=the Great Chalky Boulder Clay of S. V. Wood, Jr.) covers much of the plateau, and wraps down into the valleys in a very characteristic manner. The Glacial Sands, etc., below it also appear at times to lie on the valley-slopes. Intense glacial disturbances are found to be situated always on 'bluffs' or 'spurs' of the plateau projecting into the wide open valleys, which were thus in existence before the advent of the valley-glaciers to the action of which the disturbances have been attributed.

In each of the main valleys occur one or more buried channel of Drift; borings made recently allow these to be described in detail, and the deposits filling them to be discussed. A contour-map of the top of the Chalk is prepared for the county, and this serves to bring out the anomalies in the valleys. These buried channels were probably eroded by sub-glacial water-streams, and a comparison is instituted between them and the Föhrden of North Germany, Schleswig-Holstein, Kerguelen, etc., described in detail by Dr. Werth and others.

The evidence, therefore, indicates that the pre-Glacial or early Glacial contours of Suffolk were in the main much as they are now.

The form of the rivers and valleys suggests that some amount of capture may have taken place before the deposition of the Upper Boulder Clay; and that the present river-system is recovering from a state of arrested development, due to the 'overloading' of the valleys with Drift deposits and torrential débris during the last glaciation of the area, and to the subsidence (some 60 to 80 feet) which followed it.

2. 'The Internal Structure of Upper Silurian Rugose Corals from the Grindrod Collection, Oxford Museum.' By Donald Esme Innes, B.A.

June 11th.—Dr. Aubrey Strahan, F.R.S., President; and afterwards W. Whitaker, B.A., F.R.S., in the Chair.

The following communications were read:—

1. 'Certain Upper Jurassic Strata of England.' By Dr. Hans Salfeld, University of Göttingen.

2. 'The Volcanic Rocks of the Forfarshire Coast and their Associated Sediments.' By Albert Jowett, M.Sc., F.G.S.

The peculiar intermingling of fine sediments with the Lower Old Red Sandstone lavas of Scotland is well known from the writings of Sir Archibald Geikie. The author has found that in Forfarshire these sediments are frequently amygdaloidal, the production of the cavities having been accompanied by the buckling and fracturing of the layers of sediment. It is suggested that such effects may result from the pouring of molten rock over wet unconsolidated sediment: steam being produced within the sediment, but unable to escape owing to the presence of the overlying rock. The surface of the sediment was apparently ploughed up by the lava, the lower portion of which occasionally contains rounded nodules of hard amygdaloidal sediment. The sediment is sometimes slightly altered where in contact with the volcanic rock. Further evidence of the pouring of molten rock into water is furnished by the occurrence of a rude pillow-structure in some of the lavas.

Several lenticular conglomerates are interbedded with the volcanic rocks, resting upon eroded surfaces of the latter. The conglomerates consist of large rounded blocks of volcanic rock, enclosed in a matrix composed almost entirely of volcanic débris.

Most of the volcanic rocks are olivine-basalts, rhombic pyroxene as well as olivine sometimes being present. Some contain rhombic pyroxene to the exclusion of olivine. A few porphyrite-dykes of Lower Old Red Sandstone age are intruded in the lavas.

The fine sediments consist of a variable proportion of quartz and mica and a little felspar, together with chlorite, iron oxides, and occasional minute fragments of volcanic rock.

Calcite, quartz, chalcedony, and chlorite are the commonest minerals in the amygdaloids, in both lavas and sediments.

In the south-west of Lunan Bay, a mass of Upper Old Red Sandstone with a basal conglomerate has been found resting unconformably upon the Lower Old Red Sandstone volcanic rocks.

Fig. 6.

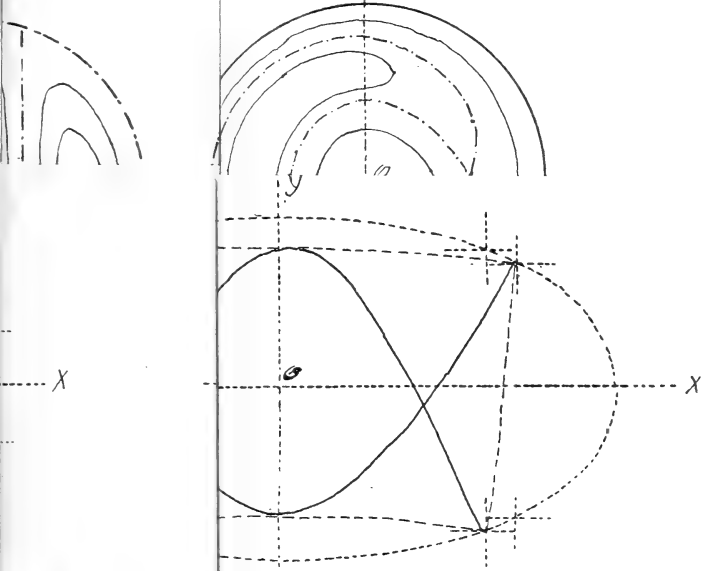
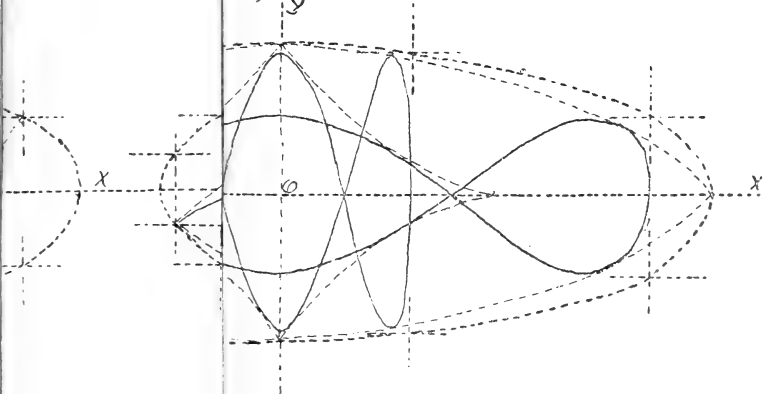

Fig. 22





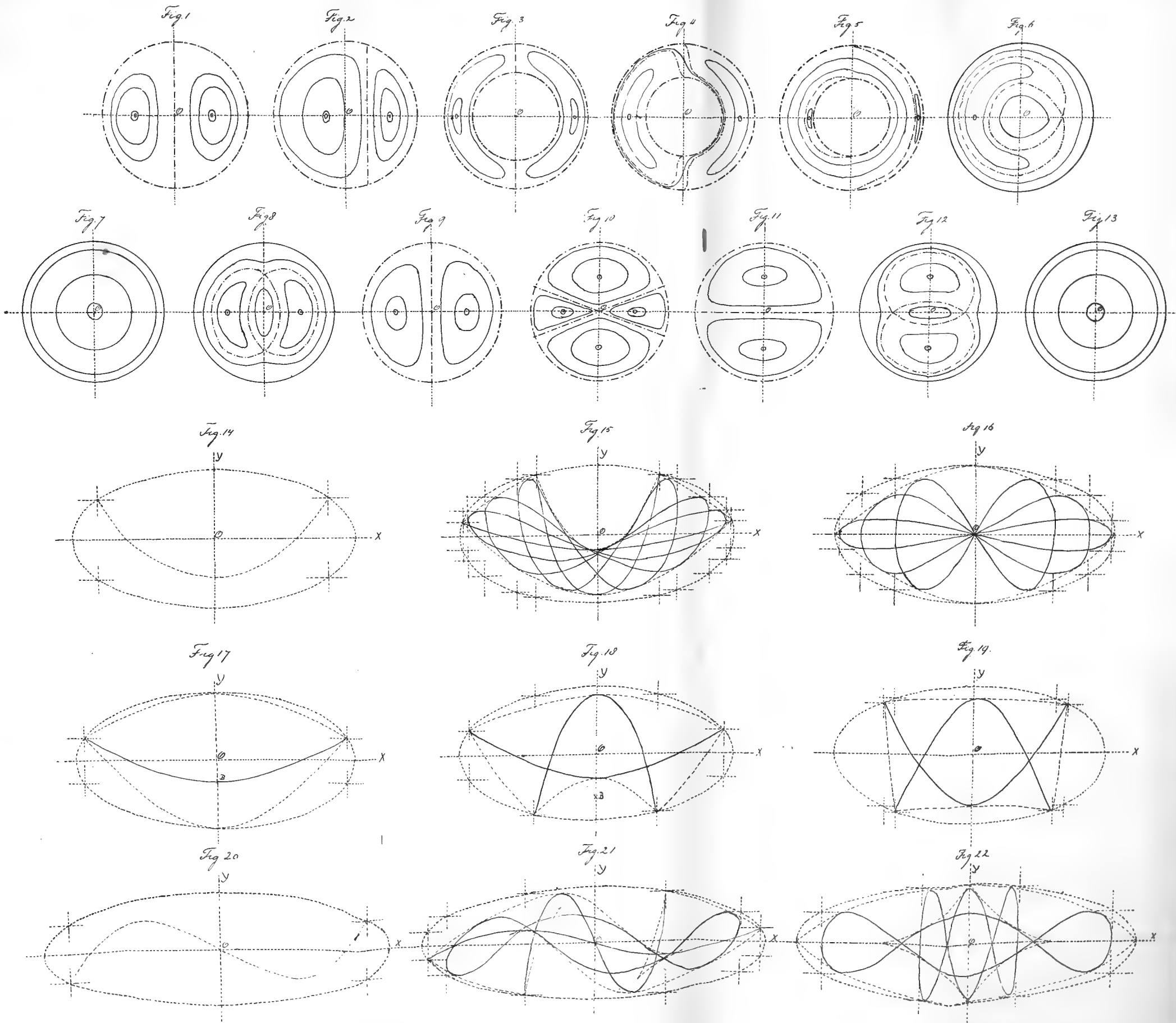



Fig. 24.

y

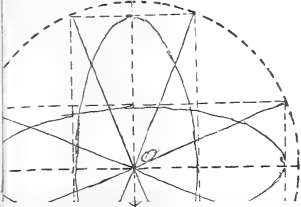

Fig. 25.

y

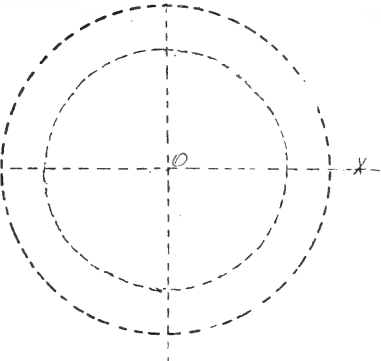
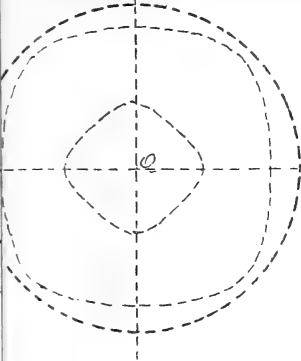
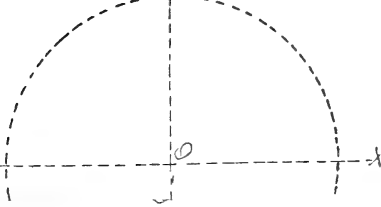
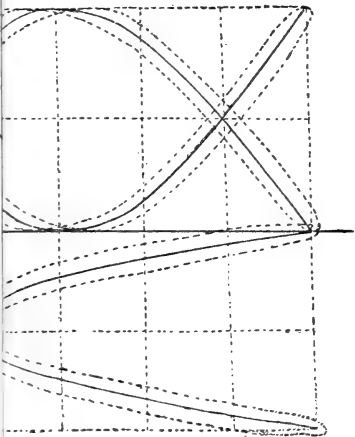
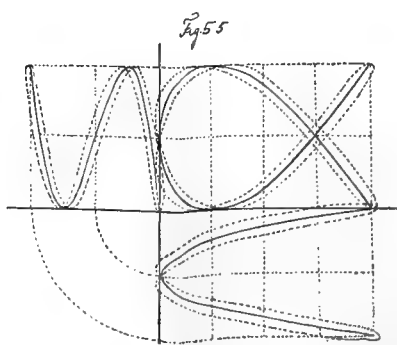
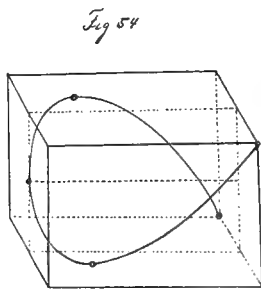
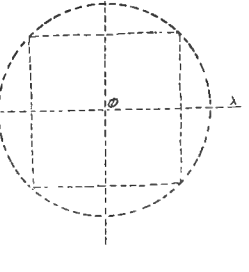
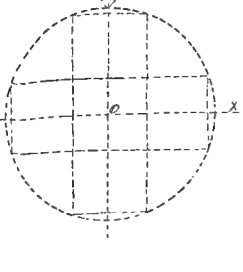
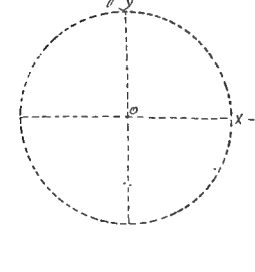
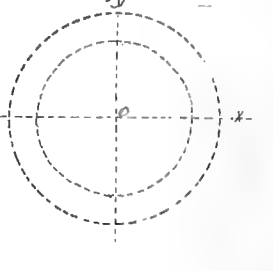
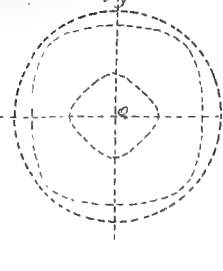
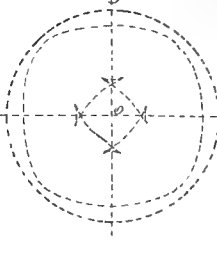
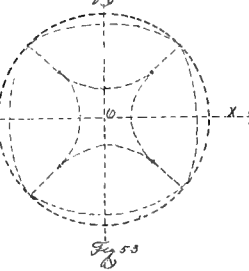
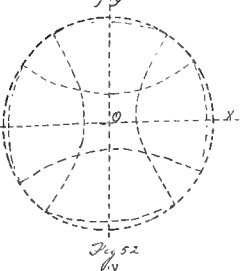
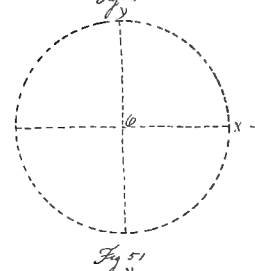
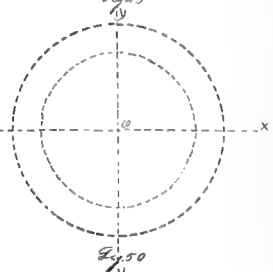
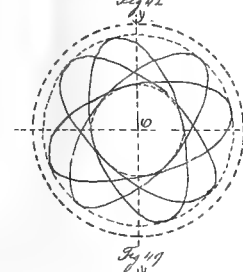
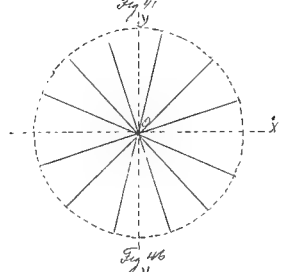
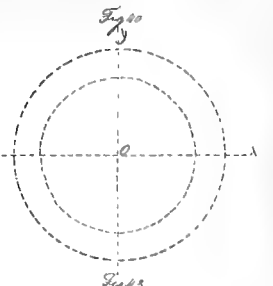
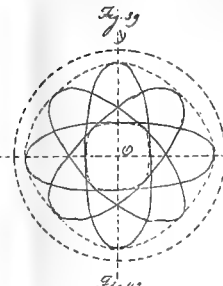
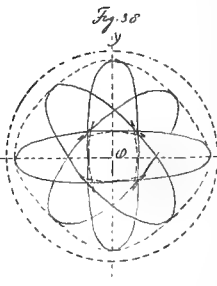
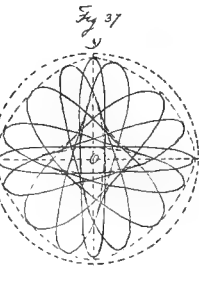
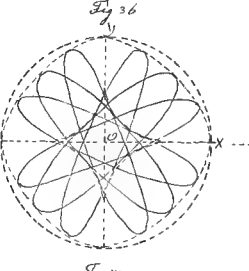
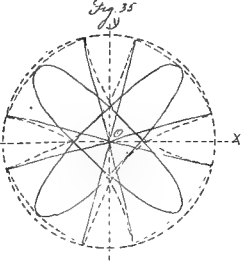
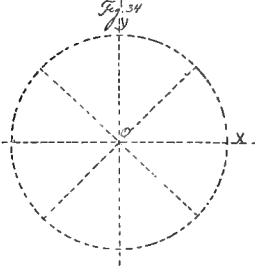
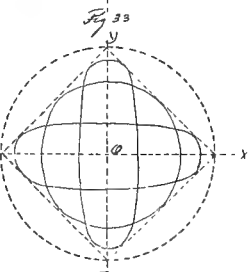
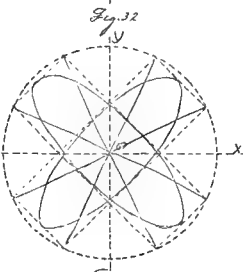
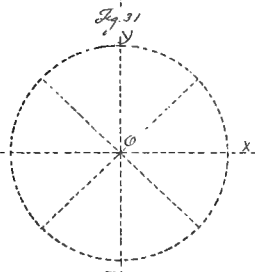
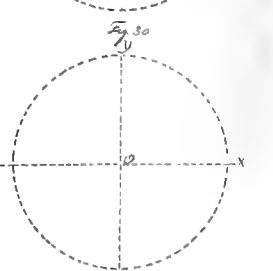
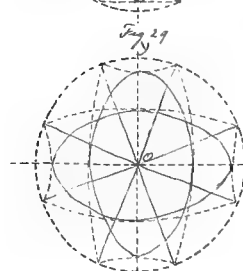
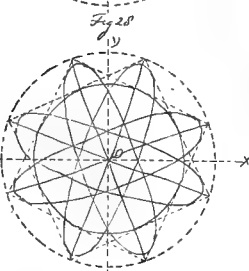
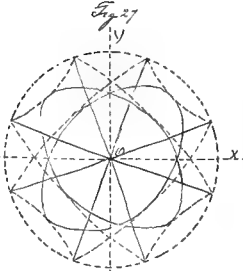
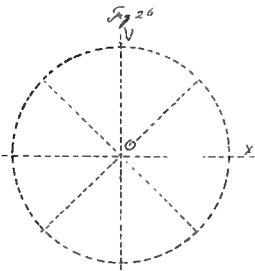
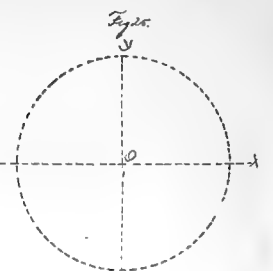
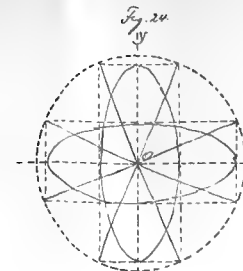
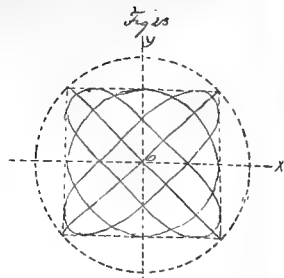

Fig. 55







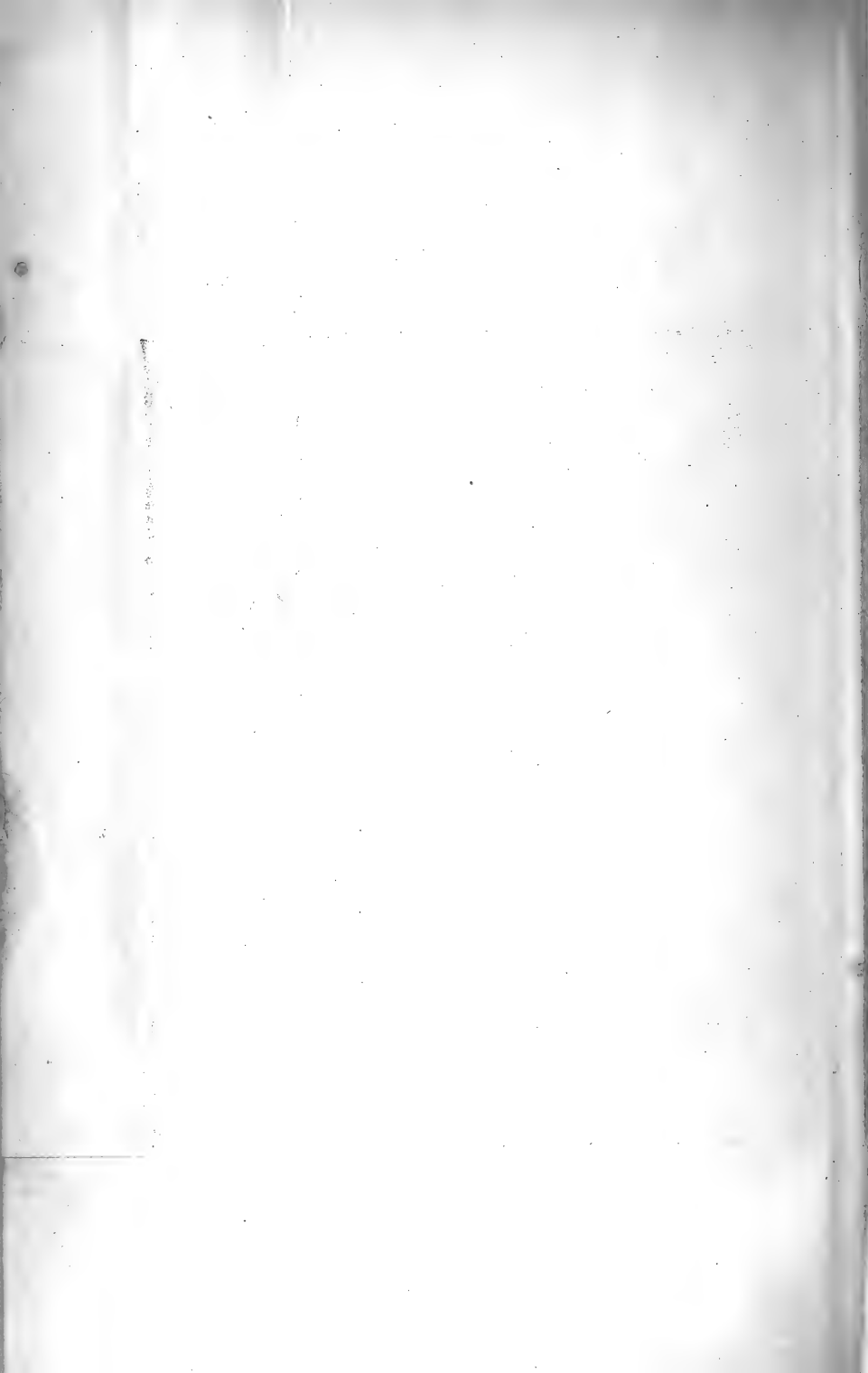

FIG. 1.

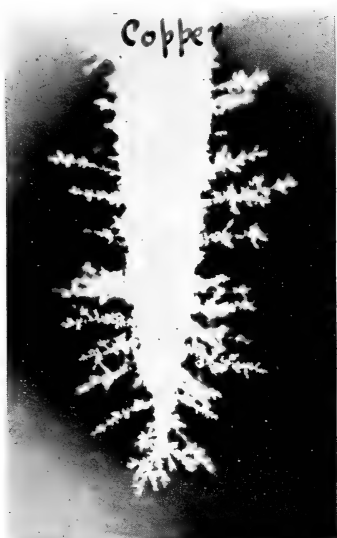

FIG. 2.



Silver - Negative



FIG. 3.

Silver - Positive.



FIG. 4.

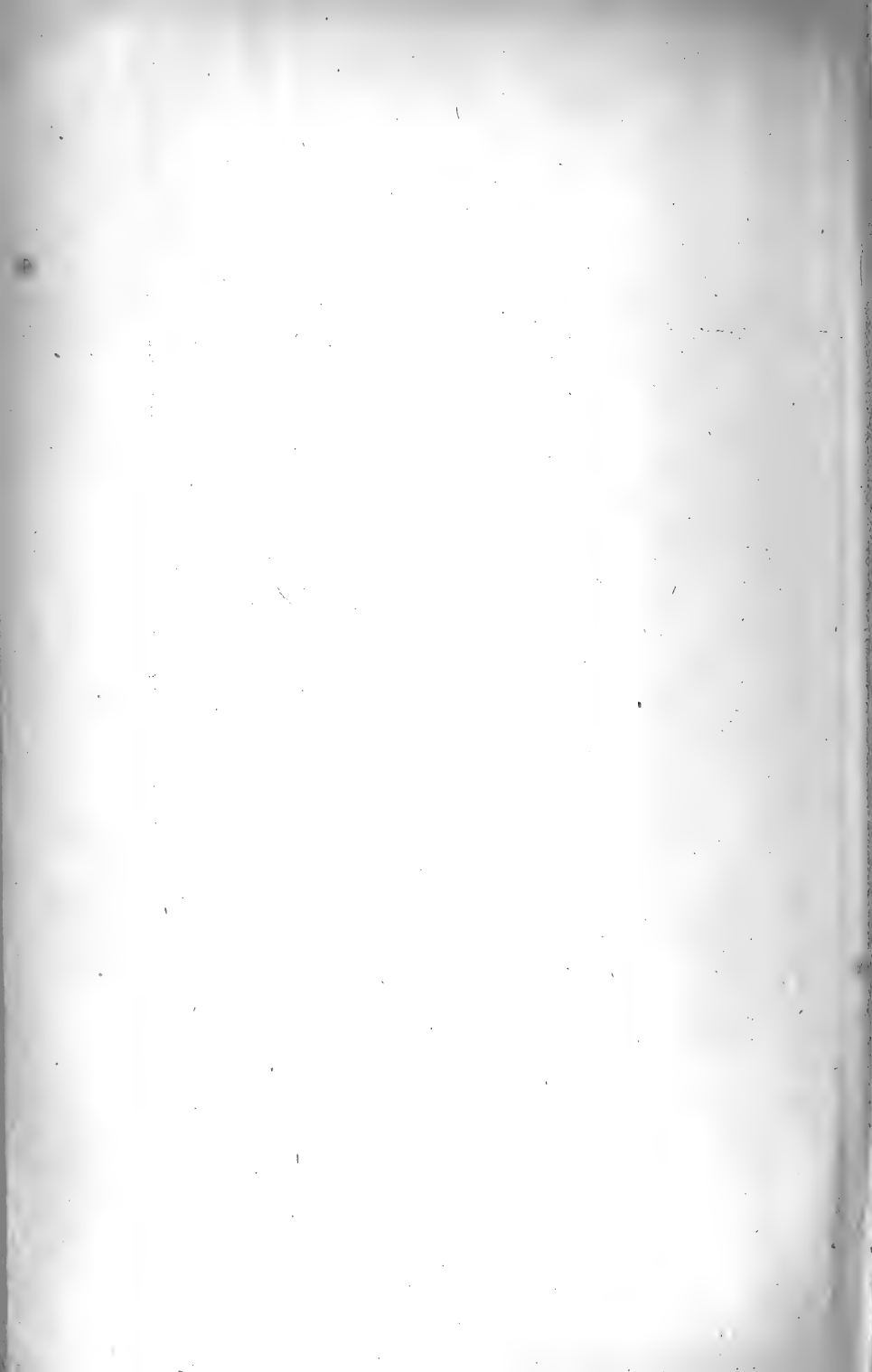

FIG. 1.

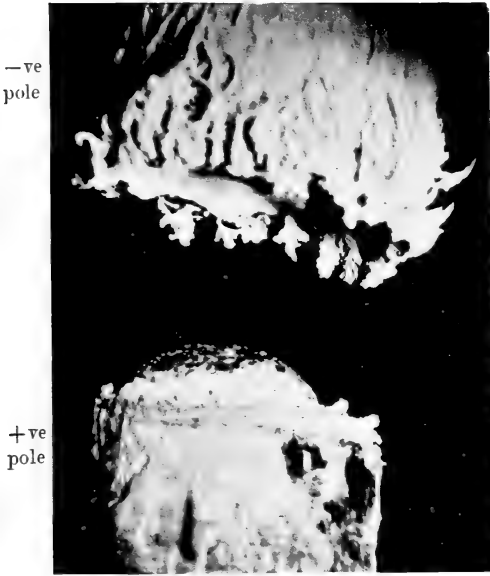

FIG. 3.

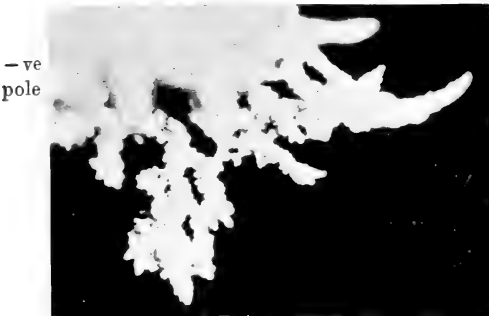
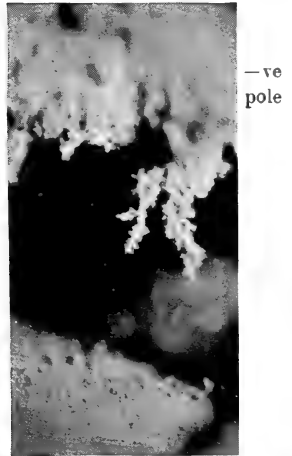
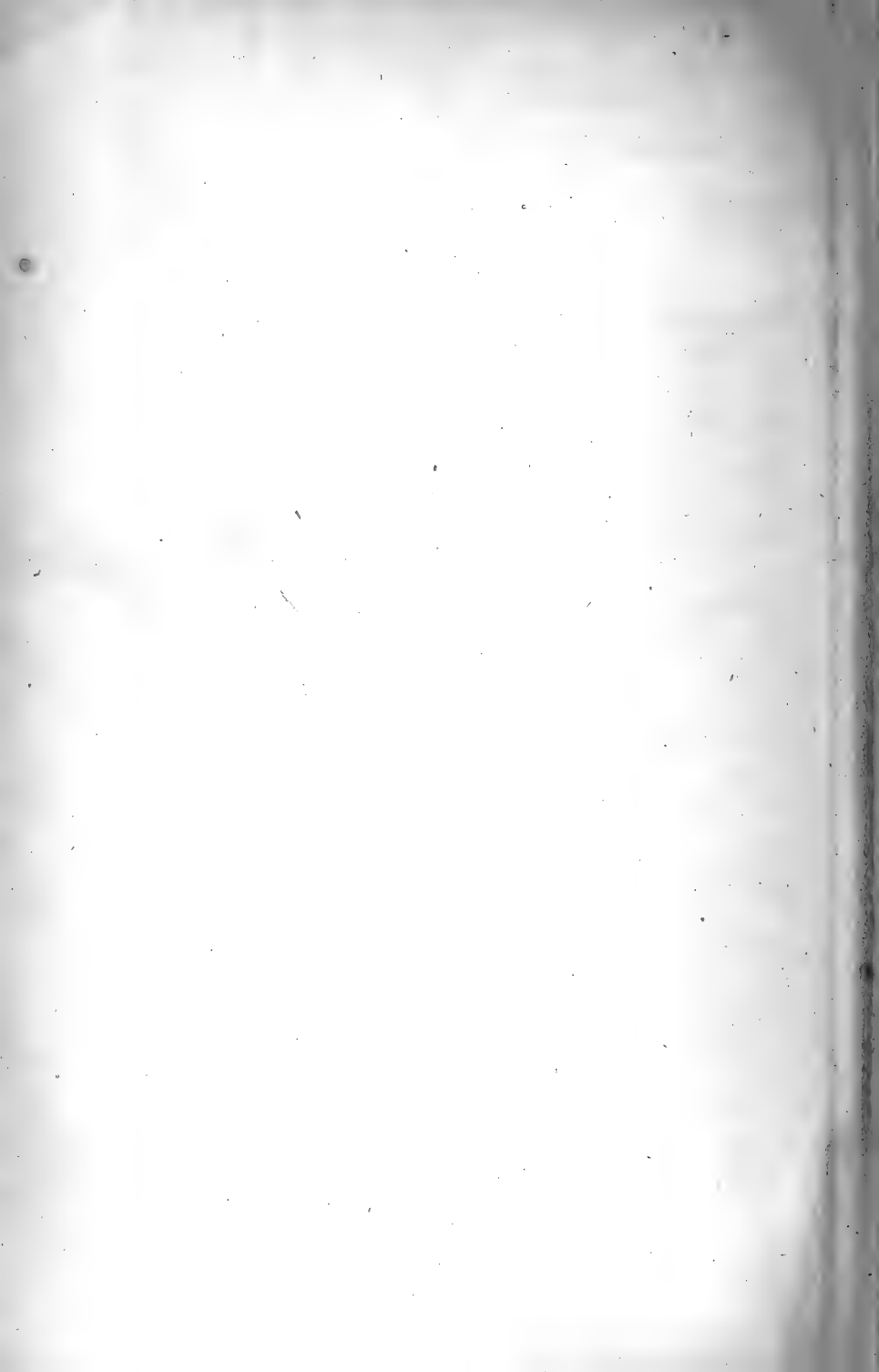

FIG. 2.



FIG. 4.

IRON.



THE
LONDON, EDINBURGH, AND DUBLIN
PHILOSOPHICAL MAGAZINE
AND
JOURNAL OF SCIENCE

[SIXTH SERIES.]

SEPTEMBER 1913.

XXIX. *The Distribution of the Active Deposit of Actinium in Electric Fields.* By H. P. WALMSLEY, M.Sc.*

IT is now generally accepted that the active deposits of thorium and radium carry positive charges, and are in consequence concentrated on the cathode in electric fields. Some doubt, however, has arisen in the case of actinium, which has exhibited a rather complex behaviour and has given rise to uncertainties in regard to the origin and sign of the charges carried by the atoms of the active deposit.

Amongst the earlier workers on the deposit of actinium, Russ† found that under certain circumstances the anode activity was nearly half that collected by the cathode, at atmospheric pressure, whereas in the case of both radium and thorium more than 95 per cent. of the deposit is collected by the cathode. At other pressures he found that great variations of the ratio of the two activities occurred. The observations led him to conclude that the electrical charge of the active deposit particles is mainly determined by the collisions between the atoms and the molecules of the gas into which the emanation diffused: in other words, by the distance traversed by the atoms before reaching the electrodes. Kennedy‡ continued the investigation, endeavouring to work with uniform fields, for he had observed that previous

* Communicated by Prof. E. Rutherford, F.R.S.

† Russ, *Phil. Mag.* xv. pp. 601, 737 (1908).

‡ Kennedy, *Phil. Mag.* xviii. p. 744 (1909).

investigators had taken no special precautions to procure these conditions. His results differed slightly in detail from those of Russ, but on the whole he obtained similar effects. Two hypotheses have been put forward to explain these results, viz. (1), that the deposit atom becomes charged in the process of its creation, and subsequently is subjected to the chances of recombination like a positive ion; and (2), that initially the deposit atom is uncharged, and that later it acquires a charge by combination with positive or possibly negative ions.

Since these results were published, a short-lived α -ray product has been discovered in the active deposits of both thorium and actinium, following immediately after the emanations. The successive changes which actinium emanation undergoes, as far as is at present known, can be illustrated in the following way:—

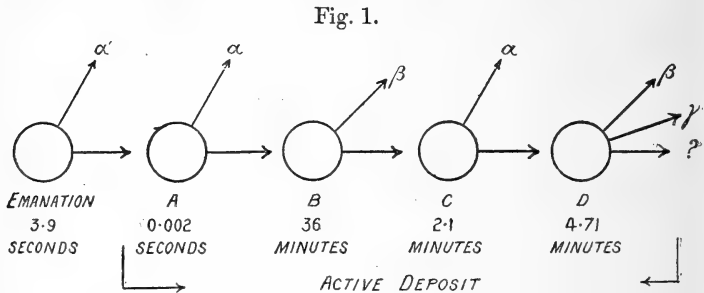

Geiger* has shown that actinium A carries a positive charge, and is concentrated on the cathode. It is possible, therefore, that the distribution of the active deposit in an electric field may depend solely on the charge of actinium A. If, when drawn on the cathode, it transforms there, we have an explanation of the high percentage cathode activity. No evidence is available as regards the electrification of the subsequent products. If actinium B were uncharged it would diffuse to both anode and cathode, so that the anode activity might be attributed to transformations occurring before the first quick-period product was all collected on the cathode. The following investigations were undertaken with a view to obtain more information on these points.

It is necessary in this type of experiment to introduce "pure" emanation into the electric fields employed, *i. e.* emanation free from dust and active deposit. If any changes occur at all in the electrification of the active deposit, it is

* Geiger, *Phil. Mag.* xxii. p. 201 (1911).

obviously necessary to eliminate "old" deposit before employing electric fields. On this account it is undesirable to allow the emanation to diffuse directly from the actinium preparation into the field, because under these circumstances a mixture of emanation and all the subsequent products, charged and uncharged, in unknown proportions, is entering the field. Changes in the strength of the electric field and in the pressure of the gas into which diffusion is occurring are bound to alter the proportions of the products, and consequently mask the true effects. Neglect of special precautions to eliminate this source of error is probably responsible for some of the discrepancies between the results obtained by the earlier investigators.

I.

The first experiment was designed to test whether, in a given electric field, the ratio of the anode activity to that of the cathode was a function of the quantity of emanation employed. A long brass tube AB (fig. 2) carrying a short

Fig. 2.

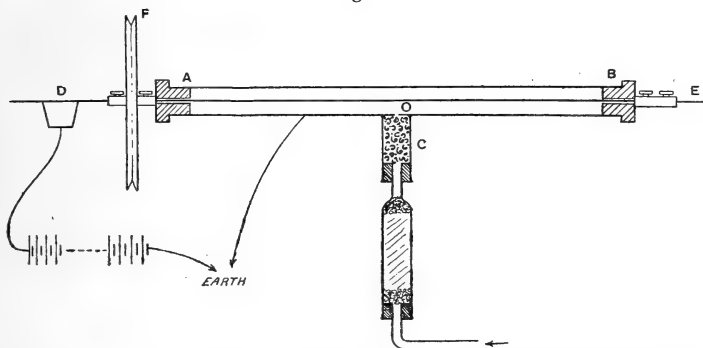

side-tube C was used. Through the centre of AB passed a copper wire DE on which the active deposit could be collected. This was supported at A and B by ebonite stoppers. The electric field was produced by earthing AB and charging the wire to a positive or negative potential by means of a battery of small accumulators. The emanation was carried into AB by a steady current of air, through the small orifice O in the side-tube, and was freed from dust and active deposit by cotton-wool which was packed tightly in C. The flow of air was produced by means of two aspirators, and the rate of flow was adjusted so that no measurable activity was found on the last few centimetres of the wire. Before reaching the actinium preparation, which was contained in a wide glass tube, the air was dried by bubbling through

concentrated sulphuric acid. The velocity of the air current was regulated by the number of bubbles per second passing through the acid. The copper wire DE was marked into sections before being placed in the tube, and was adjusted with a known mark opposite the opening O. The exposures lasted at least two hours, *i. e.* until the emanation and the active deposit were nearly in equilibrium. The wire was then cut up into sections and the activity of each measured with an α -ray electroscope. To ensure a uniform distribution of deposit over the surface of the wire, a light ebonite pulley F was attached to it and was slowly rotated by a small motor during the exposure.

The active deposit on each section was found to decay with the same period, namely, that of the long-period product actinium B. To obtain the distribution of activity along the wire, measurements were commenced ten minutes after the completion of the exposure, and the activities corrected back to this time. It was found that rotating the wire did not always ensure a uniform distribution of active deposit. Hence after each reading the section of wire was rotated inside the electroscope, and another observation taken. As a rule four measurements were available to obtain a mean value for the activity on each section. In the case of sections near the centre of the tube still more observations were taken.

Fig. 3.

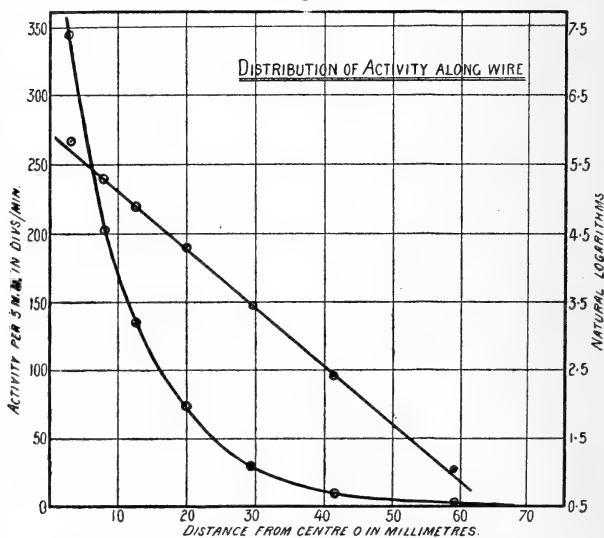

The results of a typical experiment are shown in fig. 3, which represents the distribution of activity on half the wire.

No matter whether the wire was charged positively or negatively, or not charged at all, the distribution of the active deposit along the wire, if measurable, was always the same. It decreased exponentially with the distance from the centre of the tube. If we assume that the density of the emanation at the centre of the tube is unity, then at any other point distance x from there, the density is $e^{-\lambda t}$, where λ is the decay constant of the emanation and t is the time taken for the air to traverse the distance x . If v be the velocity of the air-current $x = vt$, hence the distribution of the emanation may be written $e^{-\frac{\lambda}{v}x}$. Since this is the law of distribution of the active deposit under steady conditions, the ratio of the anode to the cathode activity is independent of the amount of emanation employed—a point of some importance in any theory of the changes occurring.

II.

By means of the apparatus just described we introduce immediately into a uniform electric field a quantity of emanation free from active deposit and dust nuclei. When an emanation atom disintegrates, the motion of the resulting deposit atom is therefore determined by the momentum due to recoil, the velocity of the air current, the motion due to diffusion and the action of the electric field. We know that the α particles projected from radioactive substances are emitted equally in all directions. Hence it follows that the motion of the deposit atoms due to recoil must be distributed in the same way, so the distribution of active matter in the gas is unaffected by recoil. If the wire and tube were earthed, the activities on them due to the diffusion of the active matter would be proportional to their areas. This result in our case may be modified by the action of the air current, for near the central portions of the wire the stream-lines are not parallel to the axis of the tube. The electric field will drag the charged deposit atoms to the electrodes. Suppose we obtain a certain amount of activity on the wire when no field is present, and that we have charged deposit atoms in the gas. If now we apply a very weak electric field, charging the wire positively, the activity collected by it will *increase* if we have *negatively* charged deposit atoms present. Similarly, if it be charged negatively, the activity collected by it will again increase, if positively charged deposit atoms are present. Hence, if deposit atoms carrying both negative and positive charges are present, we shall obtain a minimum activity on the wire when it is uncharged.

We have thus a criterion for the determination of the sign of the charges carried.

The wire was exposed as anode to the emanation, then cut into sections and its activity measured. This was repeated with the wire charged as cathode using the same voltage, and the whole repeated over a wide range of potential. The results are tabulated and are plotted in fig. 4. The accuracy of the readings varies with the position of the point on the curve. Since each reading is the sum of several measured activities, it is difficult to estimate the errors to be expected on account of the large variation in activity on separate sections. However, the determinations of the cathode activity with voltages greater than 40 varied only about 2 per cent. from one another. Judging from the way in which the anode activities vary, it appears as if we had practically attained saturation with these voltages. The anode activities were much easier to measure, and they at least can be trusted to the first significant figure for activities less than ten divisions per minute, and to a few per cent. for greater activities.

With 40 volts practically the whole of the activity is collected on the cathode, but with lower voltages more activity is observed on both the anode and the cathode than is to be expected if the distribution were due to the electric field alone. The ratio of the activity collected with an uncharged wire to the activity on the tube should be equal to the ratio of the areas of their surfaces, if diffusion alone were operative. The latter ratio was 0.10, whereas the activity collected by the uncharged wire to the maximum cathode activity is 0.16.

Fig. 4.

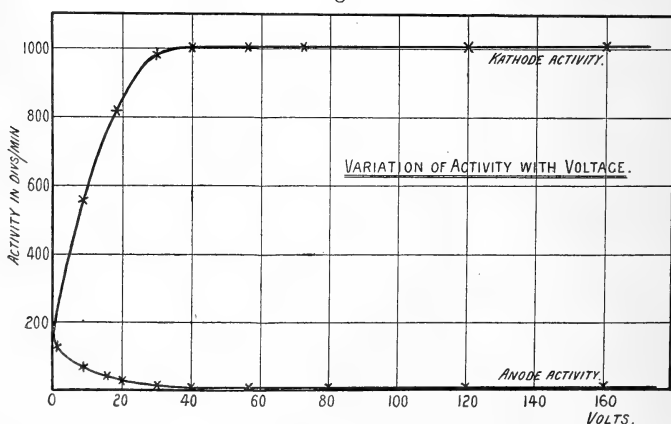

The difference is obviously due to the action of the air current near the aperture O. Since the curve (fig. 4) crosses

the axis when the sign of the voltage changes, and since the maximum activity is found on the cathode, it follows that none of the deposit atoms carries a negative charge, and that only neutral and positively charged atoms exist in the gas.

III.

Rutherford* has shown that the active deposits of thorium and radium have approximately the same mobility in an electric field as the positive ion. Schmidt† has shown that the same holds in the case of radium A. Franck‡, working with thorium D, showed that the velocity was the same as that of the positive ion in the corresponding gas. It therefore appears that one may assume that recoil atoms of all radioactive bodies behave like positive ions in the same gas. Assuming this to hold for actinium A and B, we can calculate the mean time of passage of a recoil atom out of the gas to the boundaries of the vessel. Consider two concentric cylinders radii a and b . The electrostatic force R at any point distance r from the axis is given by

$$R = V / \left(r \log_e \frac{b}{a} \right),$$

where V is the potential difference between the cylinders. Let κ be the mobility of the atom. In time δt the distance traversed by the atom is

$$\delta r = -R\kappa\delta t,$$

whence

$$\begin{aligned} t_r &= - \int_a^b \frac{r \log \frac{b}{a}}{V\kappa} dr \\ &= \frac{1}{2} \cdot \frac{\log \frac{b}{a}}{V\kappa} (r^2 - a^2). \end{aligned}$$

Consider the atoms within a ring of radius r and let their volume density be ρ . The mean time of passage T is given by

$$T = \frac{1}{\pi\rho(b^2 - a^2)} \int_a^b 2\pi r \rho t_r dr,$$

i. e.

$$T = \frac{1}{4V\kappa} (b^2 - a^2) \log \frac{b}{a}.$$

* Rutherford, *Phil. Mag.* v. p. 75 (1903).

† Schmidt, *Phys. Zeit.* ix. p. 184 (1908).

‡ Franck, *Verh. D. Phys. Ges.* xi. p. 397 (1909).

It has been shown that the anode activity is due to uncharged atoms, deposited there by diffusion and the minor effects of the air current. If the potentials are not small, the effects of the latter will be negligible. In these circumstances the percentage of uncharged atoms is given very nearly by $\frac{\text{anode activity}}{\text{cathode activity}} \times 100$.

Fig. 5.

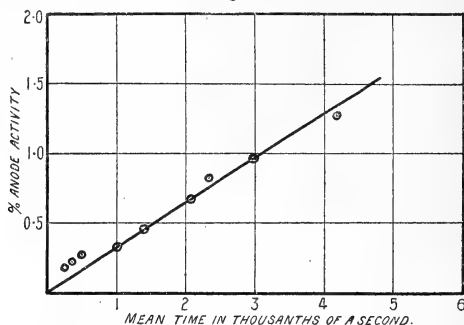

The curve (fig. 5) shows the relation between the mean time of passage in the electric field and the percentage of uncharged atoms. Since it passes through the origin, it

TABLE I.

Distribution of Active Deposit in Electric Fields.

Constants: $a=0.070$ cm., $b=0.675$ cm., $\kappa=1.54$ cm.²/sec./volt.

Volts.	Anode activity divs. per min.	Cathode activity divs. per min.	Per cent. uncharged deposit.	Per cent. deposit charged positively.	Mean time taken for deposit to reach electrodes.	Per cent. Act A reaching wire.
0	166	166	secs.	...
1.7	124	298	41.6	58.4
9.2	79	565	14.0	86.0
20	37	816	4.5	95.5	.0084	17
30	23.8	985	2.4	97.6	.0056	25
40	12.8	1004	1.27	98.73	.0042	33
56	9.8	1007	0.97	99.03	.0030	42
72	8.3	1010	0.82	99.18	.0023	50
80	6.7	0.66	99.34	.0021	53
120	4.6	1000	0.46	99.54	.0014	64
160	3.4	1027	0.34	99.66	.0010	71
336	2.7	0.27	99.73	.0005	85
490	2.2	0.22	99.78	.00034	90
640	1.8	1030	0.18	99.82	.00026	92

appears that the deposit atoms acquire their positive charge during their creation, and are then subjected to recombination like positive ions. The evidence is unfavourable to the view that initial recombination occurs, for if such occurred one would expect the curve to cut the axis of ordinates above the origin, when extrapolated. The curve showing the relation between the cathode activity and voltage must continually rise for, whatever the voltage may be, a finite though small time must elapse before the deposit atoms reach the boundary.

The atoms of actinium A produced at a distance r from the axis of the tube rapidly decay, and only a small fraction ($e^{-\lambda t_r}$), if charged, reach the wire. The total amount carried to the cathode as actinium A is therefore

$$\int_a^b 2\pi\rho r e^{-\lambda t_r} dr$$

$$= \frac{2\pi\rho V\kappa}{\lambda \log \frac{b}{a}} \left\{ 1 - \exp\left(-\frac{1}{2}\lambda \frac{\log \frac{b}{a}}{V\kappa} (b^2 - a^2)\right) \right\}$$

$$= \frac{2\pi\rho V\kappa}{\lambda \log \frac{b}{a}} (1 - e^{-2\lambda T}),$$

where T is the mean time of passage.

When V is very great this expression reduces to $\pi\rho(b^2 - a^2)$, *i. e.* the whole of the active matter carrying a positive charge is carried there. Under these circumstances the number of deposit atoms recombining is negligible. Hence the expression gives the cathode activity for large values of V . For small values of V the expression becomes

$$\frac{2\pi\rho V\kappa}{\lambda \log \frac{b}{a}},$$

which vanishes with V , as one would expect. The relation between the anode activity and the percentage of actinium A reaching the wire can be derived from the table. Until at least 75 per cent. of the deposit arrives as actinium B, the loss of charge is proportional to the time taken to get on the wire. This might have been expected, for whatever be the law of recombination of the charges with time, it must for small values of the time be linear, as can easily be shown by expansion. When the voltages employed are such that the

whole deposit reaches the wire as actinium B, the recombination still continues. It seems extremely probable, therefore, that this product also is positively charged at the moment of its creation.

IV.

If the anode activity be a measure of the uncharged active deposit, one would expect that an external source of ionization would increase it. To test this point, an α -ray tube containing about twenty millicuries of radium emanation was introduced into the brass tube AB (fig. 2) and exposures made in the usual way. In order to be able to study the distribution of the active deposit, the wire was charged positively to 16 volts. This was repeated two days later, and again after another three days. The α -ray tube was then removed and the distribution on the anode again found. The results are shown graphically in fig. 6. As the radium

Fig. 6.

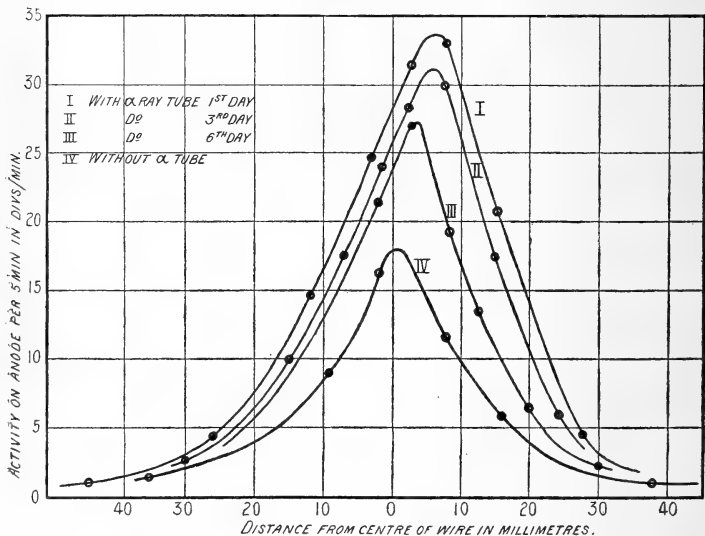

emanation decays and therefore the ionization diminishes, the active deposit collected on the anode decreases, thus showing that the anode activity is due to the deposit which has lost its charge by recombination. The displacement of the maxima is probably due to the fact that the α -ray tube was not placed exactly in the middle of the tube AB.

These results are consistent with those found by Wellisch

and Bronson* for the active deposit of radium, using low voltages. They did not detect any appreciable effect, however, using larger potential differences. This is possibly due to the relative weakness of the ionization produced by Röntgen rays—the external source of ionization which they employed. The increase in anode activity must be greater for low voltages than for high ones, using the same external ionization, since the time during which the charged deposit atoms are in the gas is longer in the former case, and hence there is a greater facility for recombination to occur. Experimenting with actinium D, Kovarik† found a very marked recombination effect even with relatively high voltages. Employing two plates 12.3 mm. apart and a potential difference of 115 volts, which was sufficient to produce an approximate saturation of the currents due to the radiations from the active deposits he employed, he showed that with a powerful ionizing source the cathode activity increased as the amount of ionization decreased. Further experiments showing the influence of voltage on the distribution of the deposit brought out the importance of the *time factor*.

On the theory of recombination it is possible to offer some explanation of the observation of Wellisch and Bronson that the percentage anode activity represents the percentage lack of saturation of the ionization current passing through the gas. They found that “within the limits of experimental error, the ratio of the two ionization currents obtained for two potentials not too low was, like the percentage cathode activity, independent of the amount of the emanation in the vessel; and, moreover, that this ratio was identical with the ratio of the percentage cathode activities corresponding to these two potentials.” The percentage cathode activity measures the amount of active deposit which reaches the electrode still charged positively. The ionization current is a measure of the number of positive ions reaching the same electrode. Since these quantities are in the same ratio, it indicates that a charged deposit atom has exactly the same chance as a positive ion of recombination with a negative ion. Although there is no *à priori* reason why radium should behave like actinium, still the hypothesis of recombination suggests an explanation for the high anode activity which Wellisch and Bronson found at lower pressures. They state that a large current due to ionization by collision was passing through the gas, during the exposure of the electrodes. In

* Wellisch and Bronson, *Phil. Mag.* xxiii. p. 714 (1912).

† Kovarik, *Phil. Mag.* xxiv. p. 722 (1912).

this case the ionization must have been very great, and hence the facility for recombination was correspondingly increased. An increase of voltage would not diminish the facility, so that a flat curve for the cathode activity would be obtained, no changes occurring in the anode activity.

V.

It was thought that an examination of the recombination of the positively charged active deposit atoms over much longer intervals of time might be of interest. Although no essentially new facts were obtained, yet a possible cause of the anomalous behaviour attributed to actinium was found. The method consisted essentially of injecting emanation into a chamber, in which it rapidly transformed, and observing the ratio of the activities collected by positively and negatively charged rods, after various intervals of time. A closed metal cylinder (fig. 7) was fixed rigidly within two closely fitting bell-jars A and B. Two glass tubes E and G passed through the stopper of the lower jar, the latter being connected to the preparation of actinium and to the pump which forced in the emanation. The upper stopper contained a short brass rod into which a copper wire, of length somewhat greater than the height of the cylinder, was fixed. To prevent the active deposit being collected on the wire before an exposure was made, a glass tube F, which could be raised or lowered at will, passed through the short glass tube E and was used as a screen. The lower end of E dipped into a vessel containing mercury, so making the whole arrangement air-tight. The actinium preparation was contained in a wide glass tube H. A tightly packed plug of glass wool at each end of the tube prevented loss of the material when a charge of emanation was blown into the apparatus. The electric field was produced by charging the wire to a fixed potential (± 80 volts), using a battery of small accumulators, and earthing the metal cylinder.

The emanation was introduced into the cylinder C as follows. The taps T and T' were opened and the reservoir K was raised until the mercury filled the tube M to a fixed mark. The air in the apparatus was then at atmospheric pressure. The tap T' was closed and K lowered a fixed distance. After the expansion had ceased, T was closed and K raised to its original position. This compressed the air in M. On opening T a sudden rush of air into the apparatus occurred, sufficient to carry a measurable amount of the emanation past the glass-wool plugs in H and past a cotton-wool plug in the end of G whose purpose was to free the

emanation entering the cylinder from active deposit. In order that the emanation in H might grow again to its equilibrium value after the expansion of the air into M, a minute was allowed to elapse between the commencement of the expansion and the inrush of air. Time was measured from the instant of opening the tap T.

Fig. 7.

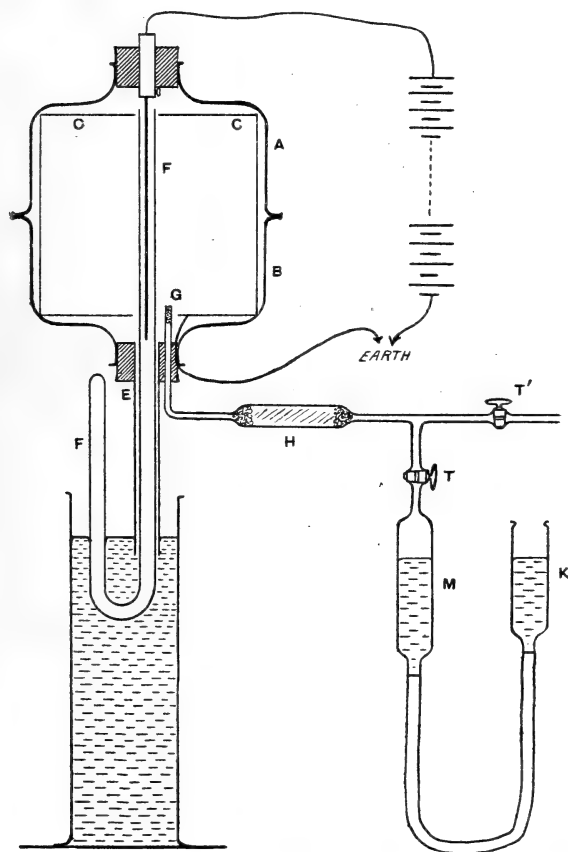

The emanation was allowed to transform into the deposit products for given intervals of time after its introduction, the tube F was then suddenly lowered, kept down four seconds, and raised again. The active wire was removed, and ten minutes after the introduction of the emanation its activity was measured with a very sensitive α -ray electroscope. If the wire were earthed during the exposure, the activity was

due solely to the diffusion of the active matter to the boundaries of the vessel. If, however, during the four seconds' exposure, an electric field was maintained between the wire and the cylinder, an increased amount of active deposit was collected. The difference in activity between these cases and the former gave the amount of active deposit actually collected by the field.

A large number of experiments were carried out and the activities collected by the wire both as anode and as cathode, after time intervals varying from 0.25 min. to 7.00 mins., were determined. Many observations were taken after the same time interval, and a most noticeable lack of consistency between the readings, and especially those taken on different days, was displayed. The latter effect was ultimately found to be due to dust, which entered the apparatus during the process of removing one wire and substituting another. It was found, however, that applying a strong electric field between the wire and cylinder, keeping the tube F in position, greatly reduced the variations. Hence before making an exposure, the wire was charged to a high potential by means of a Wimshurst machine for about two or three minutes. This would remove charged dust to the boundaries of the vessel.

The radioactive transformations occurring within the cylinder are as follows. The emanation (period 3.9 secs.) rapidly decays after its introduction, and produces actinium A (period 0.002 sec.), which in turn disintegrates into actinium B (period 36 mins.). The maximum amount of A appears after a small fraction of a second, and afterwards the amount present is approximately a constant fraction ($\frac{1}{1930}$) of the amount of emanation present. Hence for practical purposes this product may be neglected. The maximum amount of B occurs after 35.2 seconds, at which time only 0.18 per cent. of emanation remains. Hence we may assume that the amount of B present, until the maximum is reached, is given by $(1 - e^{-\lambda t})$, where λ is the decay constant of the emanation; and afterwards by $e^{-\lambda_1 t}$, where λ_1 is its own decay constant. The first exposure was made after an interval of 15 secs. At this time 6.7 per cent. of the emanation was still untransformed. Hence to make the readings comparable with those taken after 30 secs., a 7 per cent. correction is necessary. Similarly later readings require correction for the decay of actinium B. The α -ray activity by which the amount of deposit was estimated is due to actinium C (period 2.1 mins.). Its maximum occurs 9.3 mins. after that of actinium B, so to obtain full benefit

of the maximum the activities were measured ten minutes after the injection of the emanation into the chamber.

The activities collected by the wire due to diffusion alone, though small, were very consistent. The observations for time intervals increasing to 1.00 min. (fig. 8) show

Fig. 8.

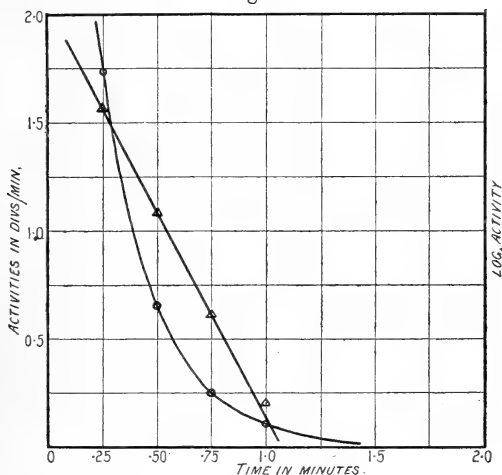

that the amount of deposit diffusing to the side of the vessel decreases exponentially with the time. The observations after this period do not agree in this respect, as a constant amount of deposit apparently seems to be always collected. This is possibly due to air currents set up when the tube F is lowered to make an exposure. The points on the curves showing the anode and cathode activities (fig. 9, p. 396) are the means of several exposures in each case. Unfortunately the sources of experimental error are extremely numerous in this experiment, so that the values given are not of a high order of accuracy. After one minute the difference at any time interval between the activities collected by the wire charged as anode and as cathode, was less than the probable errors in the values given, so that we may assume that the curves coincide about this time. The curves become approximately horizontal after the two minutes interval. The value of the constant activity was found to vary from time to time. An explanation of this is offered later. Since the anode and cathode activities are ultimately equal, the active deposit at these times must be uncharged. Hence the curve giving the anode activity shows the amount of uncharged deposit after any time. The difference between the two

curves is a measure of the positively charged deposit existing in the chamber at any time. If this were corrected for the diffusion of the active matter to the walls of the vessel, the resulting values would show the law of loss of charge of

Fig. 9.

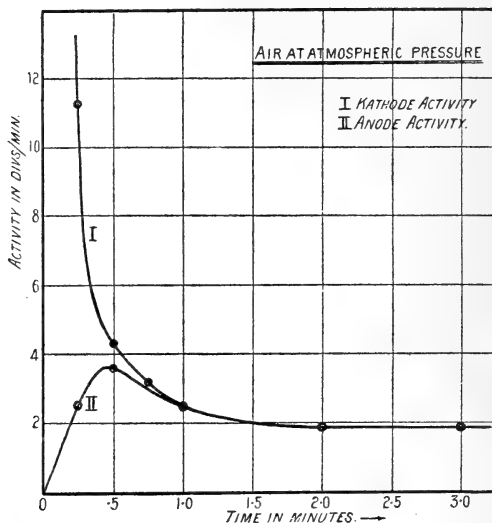

the active deposit. It seems extremely probable that the curve would satisfy the ordinary law of recombination of positive ions, but the experimental values are not sufficiently accurate to test the point. The evidence shows, however, that actinium B continues to recombine until it is all electrically neutral.

The necessity of employing the cotton-wool plug G to remove active deposit from the emanation as it enters the chamber, can be well shown with the apparatus. The curves fig. 10 show the resulting measurements obtained by this method, when the plug G is omitted.

VI.

Attention has been drawn throughout this paper to the necessity of eliminating dust from the air into which the emanation is introduced. The rôle played by dust was forcibly brought out during the work on actinium B, for it was found that if this was not removed, it was possible, under certain circumstances, to obtain more activity on the anode than on the cathode. Atmospheric air is known to

contain certain quantities of suspended microscopic solid matter, which it retains for long periods. Suppose now we have emanation transforming in the presence of dust-laden air, what effects are we to expect? The common observation that radioactive deposits adhere to solid surfaces, seems

Fig. 10.

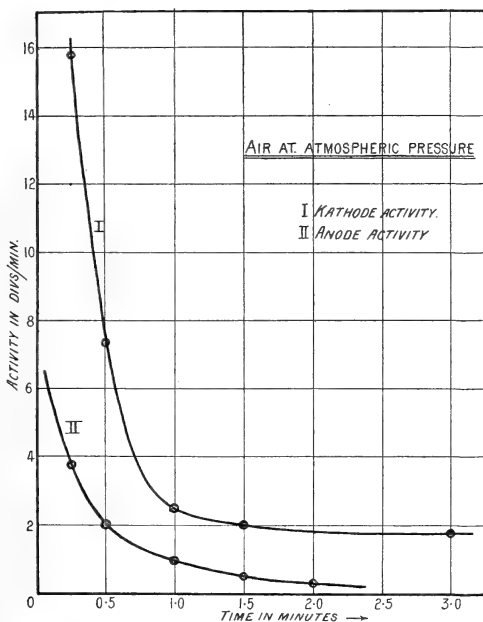

to indicate that the "rest-atoms" are subjected to intermolecular forces of a cohesional nature in the presence of matter in the solid state, irrespective of any forces developed by virtue of their positive charges. We should expect, therefore, even if the dust were uncharged, that it would receive a deposit of active matter, and if it happened to possess by any chance a negative charge, an additional attraction for the active deposit would be furnished. Hence we might expect active matter to remain suspended, for long periods, in dusty air near radioactive preparations.

This was long ago noticed by Miss Brooks*. She found that if air, which had not been previously rendered free

* Miss Brooks, *Phil. Mag.* viii. p. 373 (1904).

from dust, was left undisturbed in the presence of thorium emanation for a period of about eighteen hours, and a negatively charged rod was then introduced into the vessel for one minute, the decay of the radiations from the rod after removal was the same as that of a rod which had been exposed for a period of eighteen hours. If, however, the dust was removed from the air by passing through a plug of glass-wool, or by keeping the emanation in an electric field, the activity obtained on the rod under similar conditions decayed with the correct period as deduced from the constants of the transformation products. This decisively proves that active deposit settles on dust and remains for long periods suspended in still air. If the dust had carried a negative charge, it is possible that the charge carried by the active deposit was not sufficient to neutralize it. In this case the dust carrying the active deposit would be collected on the positive electrode in an electric field. The experiments on actinium B have shown that the active deposit in dust-free air rapidly diffuses to the sides of the vessel. Dust and large nuclei carrying active deposit would probably, from their larger size, diffuse much more slowly. In time, therefore, it is possible that if an electric field were employed,

Fig. 11.

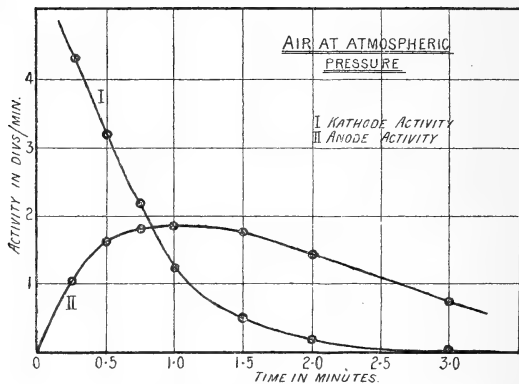

more activity could be collected on the anode than on the cathode. This has actually been observed. If the Wilmshurst machine were not employed to remove dust-nuclei from the chamber before making an exposure, curves of the same type as that in fig. 11 were obtained. It was found

that observations on various occasions gave different relative values to the anode and cathode activities under these circumstances. This is no more than might have been expected, since there is no reason why the amount of dust, and especially dust negatively electrified, should be constant over long periods of time.

It still remains to be proved that the dust and nuclei actually carried a negative charge. No direct evidence was obtained. Pollock* has shown that the majority of the large ions found in the atmosphere at Sydney carry negative charges. These slowly moving ions would collect active deposit, and therefore act in the above manner. Rudge† has recently shown, in his work on the electrification associated with dust clouds, that in England atmospheric dust is usually negatively electrified. This was confirmed to some extent, by taking samples of dust from shelves, &c., in the laboratory that had not been disturbed for some time. This was tested by Rudge's method. Many samples showed little or no electrification when blown into a cloud, but some samples, consisting of very fine material collected from the more inaccessible places, exhibited a fairly strong negative electrification.

If the supply of negatively charged dust is sufficiently great, it may happen that most or all of the active deposit is eventually collected by the dust. Under these conditions, the variation of anode and cathode activity with time would be such that it would appear as if the active deposit originally possessed a positive charge, and on recombination reversed its electrification. This particular case is strikingly shown in fig. 11‡. If we add together the anode and cathode activity, we obtain a curve which will represent the amount of activity present in the chamber at any time, provided that the amount of active deposit carrying no charge, which collects on the electrodes by diffusion, is negligible. This curve was found to be roughly exponential and represents the rate at which the active matter, as a whole, is carried to the walls of the vessel by diffusion. If we correct the observed values by means of this curve for diffusion, we

* Pollock, *Le Radium*, vi. p. 129 (1909).

† Rudge, *Phil. Mag.* xxv. p. 481 (1913).

‡ I am indebted to Miss Doris Bailey, B.Sc., for the curves in fig. 11. Under the direction of Professor Rutherford she performed most of the preliminary work on actinium B during the session 1911-1912 and generously placed her results at my disposal.

obtain fig. 12. The cathode activity decreases roughly exponentially with time, and the anode activity rises as the

Fig. 12.

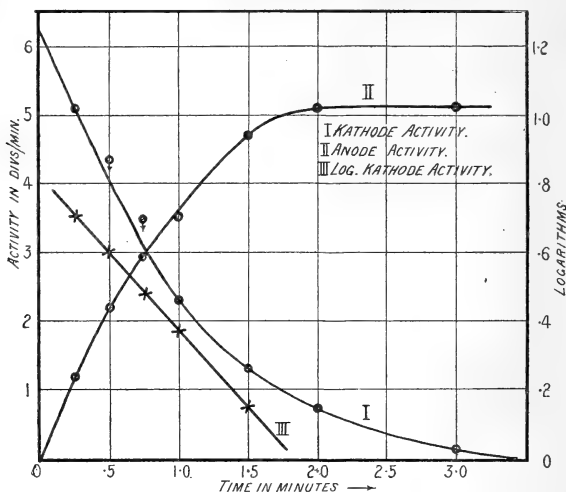

complementary curve to a maximum which is nearly equal to the initial amount of deposit present. This result is in agreement with the ordinary law of recombination. If N_t be the number of positively charged active deposit atoms present at time t and n is the number of negative charges present either as ions or on dust, the law of recombination is given by

$$- \frac{dN_t}{dt} = \alpha n N_t,$$

where α is the constant of recombination. If n is sufficiently large compared with N_t over the time necessary for the complete recombination of the active deposit, we may treat αn as a constant (equal to k say), whence

$$N_t = N_0 e^{-kt}.$$

If recombination occurs with negatively charged dust particles, the number of atoms *apparently* acquiring a negative charge is proportional to the number recombining. Let M be the number settling on negatively electrified dust-nuclei,

$$\text{then} \quad \delta M_t \propto \delta N_t,$$

$$\text{i. e.} \quad \frac{dM}{dt} = -k' \frac{dN}{dt},$$

where k' is the new constant of proportionality.

Integrating, $M = C - k'N_0 e^{-kt}$.

Since $M = 0$ when $t = 0$,

$$C = -k'N_0,$$

and the solution becomes

$$M = k'N_0(1 - e^{-kt}).$$

If the whole of the deposit settles on dust which afterwards still retains a negative charge, k' becomes equal to unity. In the case given $k' = \frac{5}{8}$ approximately.

The recombination of the active deposit has apparently a half-value period of 0.77 min. This period is unchanged when the gas employed is either air, carbon dioxide, or hydrogen, showing the effect is purely one of recombination. The figs. 9 and 11 represent, therefore, two extreme cases of the way in which the active deposit may distribute itself. All variations of anode and cathode activity are to be expected between these limits, when air containing large ions or dust particles is employed, and one is in consequence led to attribute some of the discrepancies in the early work on the subject to this cause.

Summary.

1. It has been shown that the distribution of the active deposit of actinium between the electrodes in an electric field is independent of the concentration of the emanation.

2. Actinium A has been shown to acquire its positive charge in the process of its creation, and in all probability the electrical charge of actinium B has the same origin.

3. As regards their electrical properties, both actinium A and actinium B behave exactly like the positive ions produced by their radiations. They recombine in exactly the same way, and the activity collected by the anode in an electric field is due solely to deposit atoms which have recombined.

4. Under favourable circumstances recombination continues until the whole of the active deposit is electrically neutral.

5. The anomalous behaviour previously noticed was probably caused by the use of emanation containing active deposit, and dust-laden gases.

In conclusion I wish to express my best thanks to Professor Rutherford for his kindly interest and advice throughout the course of this investigation and for the loan of the large preparation of actinium.

The Physical Laboratories,
The University, Manchester,
May 1, 1913.

XXX. *The Range and Ionization of the Alpha Particle in Simple Gases.* By T. S. TAYLOR, Ph.D., John Harling Fellow, University of Manchester*.

Introduction.

THE problem of the absorption of the alpha particles by matter has been considered theoretically by Sir J. J. Thomson †, Darwin ‡, and Bohr §. In any treatment of this problem the exact range of the alpha particle in the substances considered is an important constant. The rate at which the number of particles near the end of the range decreases, and also the form of the ionization curve for different substances, are helpful in the consideration of the laws of absorption of the alpha particles. The range of the alpha particles and the ionization produced by them have received considerable attention by various investigators. The results obtained from the investigations on the elementary gases are of especial theoretical interest. As yet the absorption of the alpha particle in the simplest gas, helium, has received but little attention. The range of the alpha particles from polonium has been determined by Adams ||, but the range of the alpha particle from radium C and the ionization curve for the alpha particle in helium have not been investigated. It was for the purpose of investigating the latter and allied problems, as well as redetermining some of the above-cited values, that the present investigation was begun.

The Ranges of the Alpha Particles from Radium C and Polonium in Hydrogen, Helium, Oxygen, and Air.

In this determination of the ranges of the alpha particles, the scintillation method was used. The apparatus (fig. 1) consisted essentially of a long glass tube closed at each end by means of a piece of sheet-glass fastened down with wax. Upon the inner surface of one of these plates over the ends of the tube was a zinc-sulphide screen. The scintillations were observed by means of a microscope E. A side tube as shown in the figure leads to the pump, charcoal bulbs, manometer, and pressure chamber. The pressure in the chamber as well as that in the apparatus could be varied at will by

* Communicated by Prof. E. Rutherford, F.R.S.

† J. J. Thomson, 'Conduction of Electricity through Gases,' pp. 370-382.

‡ C. G. Darwin, *Phil. Mag.* xxiii. p. 907 (1912).

§ N. Bohr, *Phil. Mag.* xxiv. p. 10 (1913).

|| E. P. Adams, *Physical Review*, xxiv. p. 113 (1907).

raising and lowering the mercury reservoir connected to the pressure chamber. The source of rays, either radium C or polonium, was fastened to the end of an iron plug L, which could be moved along the tube to any desired position by means of an electromagnet placed astride the tube. For radium C, the source was an active platinum wire which had been exposed to radium emanation. The polonium was deposited upon the end of a small copper plug which was fastened to the iron plug L by means of wax.

Fig. 1.

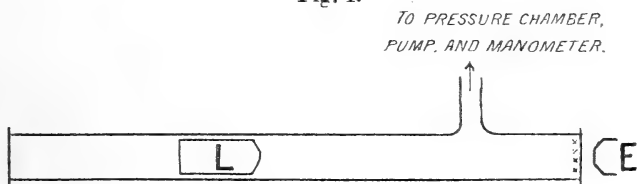

In making the determination of the range in any case, the iron plug was moved along the tube till the scintillations were visible. This adjustment of course was only made approximately. The pressure of the gas in the tube was then carefully adjusted by raising or lowering the mercury reservoir connected to the pressure chamber, till the scintillations just disappeared. The pressure of the gas was then read from the manometer, the temperature taken, and the distance of the source from the zinc-sulphide screen determined by means of a cathetometer placed parallel to the tube. The pressure of the gas was adjusted several times for each position of the source and the mean value of the pressure taken for the given position. The source was then moved slightly to a new position and the same observations taken. Each set of readings was then reduced to normal conditions of pressure and temperature, 760 mm. pressure and 0° C. temperature. The decrease in the number of the alpha particles towards the end of the range was also determined. The results of the latter experiments are described in the following section.

The values of the ranges of the alpha particles from radium C and polonium were obtained in the above manner in hydrogen, helium, oxygen, and air. The mean values found are recorded in Table I. Each of the values in Table I. is the mean of at least twelve separate determinations, none of which varied more than 1 part in 400 for air and oxygen and 1 part in 300 for hydrogen and helium.

TABLE I.

	Range at 760 mm. and 0° C.		760 mm. and 15° C.		Ratio of Ranges.
	Polonium.	Radium C.	Polonium.	Radium C.	
Air.....	3.57 cm.	6.57 cm.	3.77 cm.	6.93 cm.	1.84
O ₂	3.25	5.94	3.43	6.26	1.83
H ₂	1.95	29.36	16.83	30.93	1.84
He.....	16.70	30.84	17.62	32.54	1.84

Each of the gases contained only a relatively small quantity of impurities. The oxygen formed by dropping, very slowly, distilled water upon the commercial "oxylith," contained certainly not more than one-third per cent. of impurities. The hydrogen was formed by the electrolysis of distilled water containing a small trace of sulphuric acid. It probably had as much as $\frac{1}{2}$ to $\frac{3}{4}$ per cent. of impurities. The helium was passed repeatedly through charcoal in liquid air, and certainly was as pure as can be obtained by this process. The impurities in the gases were not sufficient to cause a variation in the results much greater than that due to experimental errors.

The Diminution of the Number of Alpha Particles from Radium C near the End of the Range in Hydrogen, Helium, Oxygen, and Air.

The apparatus used in these determinations was the same as that shown in fig. 1. The method of determining the decrease of the number of the particles towards the end of the range in each gas may be illustrated by describing an experiment for air. The active wire was placed so as to be say 6.5 cm. from the zinc-sulphide screen and the end of the tube sealed. The number of scintillations upon the zinc-sulphide screen within the field of the microscope was determined. By observing the pressure of the enclosed gas, the temperature, and the exact distance of the source from the screen, the equivalent range, at 15° C. and 760 mm. pressure, of the particles falling upon the screen could be calculated. The pressure was then increased slightly and the scintillations again counted. From the new pressure, temperature, and distance of source from the screen the equivalent range, at 15° C. and 760 mm., of the particles falling upon the screen was calculated as before. This process was continued till there were no more scintillations visible save the few due to the occluded emanation in the

wire. The pressure was also decreased slowly by steps, the scintillations counted, and the equivalent range calculated for each pressure until the number of scintillations became constant. This occurred for an equivalent range of about 5.8 cm. The source was then moved to slightly different positions and the above observations repeated for each position. Account was taken of the decay of the source while the observations were being made, and the results corrected accordingly. The experiment was repeated several times for each gas, and the mean values of all observations taken for final results. Curve II. fig. 2 represents the mean results for air. The ordinates are the observed scintillations per minute, and the abscissæ are the corresponding ranges at 15° C. and 760 mm. It is seen from Curve II. that there is a rather slow decrease in the number of particles from 5.9 cm. to about 6.3 cm. range, and then the number decreases quite rapidly, but almost uniformly, to the end of the range. The intersection of this curve with the axis gives the range in air.

Fig. 2.

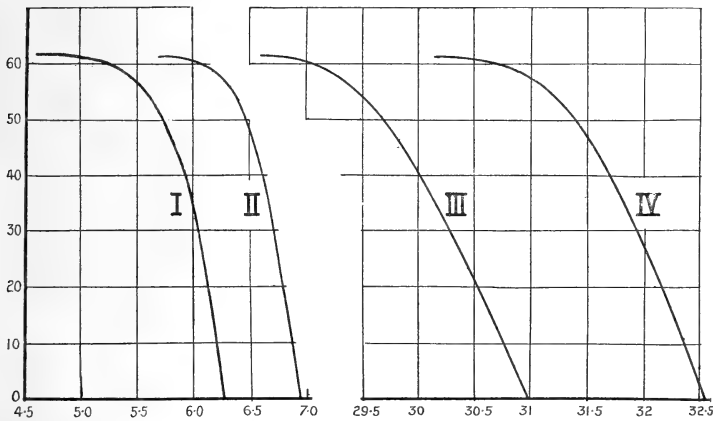

The ordinates for all curves are the scintillations per minute. The abscissæ for I., II., III., and IV. are the ranges in centimetres of the alpha particles from radium C in oxygen, air, hydrogen, and helium, respectively.

Experiments were performed in the above manner for each of the gases oxygen, hydrogen, and helium. The mean results obtained are represented by the Curves I., III., and IV., respectively, in fig. 2. There is but little difference between the rates of decrease of the number of particles near the end of the range in oxygen and air. The small difference

that does exist indicates that the average range of the alpha particle is about one millimetre nearer the end of the range in air than it is in oxygen. A similar difference is shown between hydrogen and helium. If we compare the decrease in the number of particles toward the end of the range in oxygen or air with that in hydrogen or helium, a more marked difference is observed. For example, if the air and hydrogen curves in fig. 2 were plotted on the same scale, the decrease in the number of particles would commence about 2.2 cm. before the end of the range in hydrogen, while that for air (on hydrogen scale) would begin about 4.5 cm. before the end of the range. From this it is seen that—for the gases of small atomic weight—hydrogen and helium—the beam of particles remains more nearly uniform towards the end of the range than it does for the gases—oxygen and air—of higher atomic weight. This is what should be expected from the theory of the scattering of the alpha particles by matter as developed by Rutherford*. The heavier the atom through which the particle passes, the greater the angle through which the particle is turned from its course. The decrease in the number of particles near the end of the range has been investigated carefully by Geiger†. The results given herein for air agree with his investigations.

The Ionization Curves for the Alpha Particles from Polonium in Helium, Hydrogen, and Air.

The apparatus used in the determination of the ionization curves was a modified form of a Bragg ionization vessel. The essential parts are shown in fig. 3. An electroscope, however, was used to measure the ionization current on account of its extreme steadiness and the ease with which observations could be repeated. By using an electroscope it was not convenient to use a shallow ionization chamber on account of the length of time required for a single reading. Consequently, the ionization chamber I, fig. 3, was a brass cylinder about 2.5 centimetres in diameter and 2.4 centimetres high, and was fastened to the end of a glass tube about 2.4 centimetres in diameter. This cylinder was charged to a negative potential of 160 volts by being always connected to a battery. A small central electrode, insulated by means of good sealing-wax, was joined through a mercury earthing and charging key to an electroscope. The electroscope and electrode were always charged to a positive

* Rutherford, 'Radioactive Substances and their Radiations,' p. 180.

† Geiger, Proc. Roy. Soc. A. lxxxiii. p. 505 (1910).

potential of 160 volts, except while taking the observations when it was insulated. There was thus a potential difference of 320 volts between the electrode and the walls of the ionization vessel. This was sufficient to ensure a high degree of saturation, but not enough to produce ionization by collision, even in helium. A wire gauze connected to earth was placed about 2 mm. from the gauze forming the top of the ionization vessel and served with it as a guard chamber.

Fig. 3.

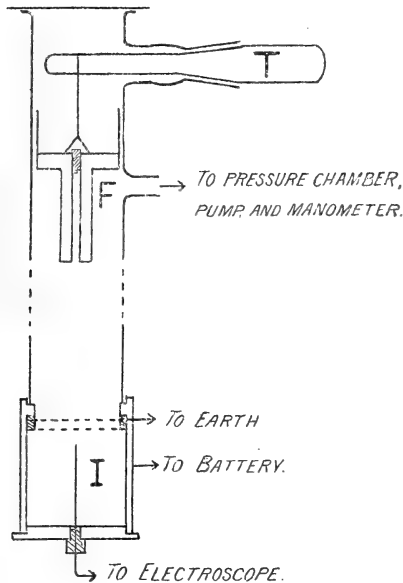

The source of rays, polonium, was upon the end of a small copper plug inserted in a larger plug F, that had a small opening 2.5 mm. in diameter through it in order to limit the beam of rays so that it would fall well within the ionization chamber. The polonium could be moved towards or away from the ionization chamber at will by means of a string wrapping around the glass rod T that extended into the vessel through a ground-glass joint. The top of the vessel was closed by waxing down a glass plate over it. A side tube joined the vessel to the pressure chamber, pump, and manometer. The distance of the source from the ionization chamber could be determined by means of a scale parallel to the apparatus.

Since the ionization vessel was 24 millimetres high it was necessary to use the method of differences in order to obtain

the ionization over a short distance. This was done by advancing the source towards the ionization chamber in steps of 3 millimetres each and observing the rate of leak of the electroscope for each position. Then the difference between the readings obtained for two successive positions gave the difference between the ionization produced in the 3 millimetres of the path of the rays that had been moved beyond the limits of the ionization chamber and that produced in the 3 millimetres of the path just added to the limits of the chamber. Thus, the difference between the readings obtained for the source at 10 cm. and 10·3 cm. respectively from the ionization chamber gave the difference between the ionization produced in the 3 millimetres of the path, 10 to 10·3 cm., and that produced in the 3 millimetres 12·4 to 12·7 cm. The part of the path of the rays 10·3 to 12·4 cm. was common to both positions. The method of deriving the ionization curve may be illustrated further by the data recorded in Table II., which is a partial set of readings for hydrogen. The values in the columns under "Range" are the distances of the source from the gauze forming the top of the ionization vessel. The values under "Ionization" represent the relative rates of leak of the electroscope due to the ionization in the vessel for the corresponding distances of the source from it, the natural leak of the electroscope and the apparatus being subtracted. The values under "Ionization per 3 millimetres" are the values of the ionization for a shallow ionization vessel, 3 millimetres deep, as derived from the values in the previous column by the method cited above.

TABLE II.

Range.	Total Ionization in chamber.	Ionization per 3 mm. of path.	Range.	Ionization.	Ionization per 3 mm. of path.
17·6	0	0			
17·3	1·6	1·6	14·9	87·9	11·0
17·0	5·9	4·3	14·6	94·1	10·5
16·7	14·0	8·1	14·3	95·7	9·7
16·4	26·2	12·2	14·0	92·7	9·2
16·1	40·1	13·9	13·7	87·6	8·8
15·8	54·0	13·9	13·4	82·0	8·3
15·5	66·6	12·6	13·1	77·2	7·8
15·2	78·5	11·9	12·8	73·0	7·7

By plotting the values, derived in the above manner, for the ionization per 3 millimetres of the path against the corresponding range, the ionization curve was obtained.

Since the source could not be moved closer than 4 centimetres to the ionization vessel, the form of the curve from 0 to 4 centimetres was assumed to be the same as the prolongation of the part of the curve above 4 centimetres. Such an assumed form of the curve cannot be far from correct.

Fig. 4.

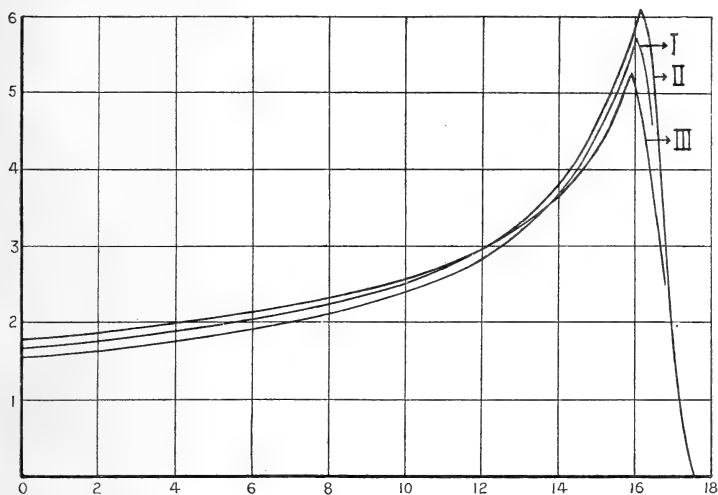

The ordinates are the relative ionizations. The abscissæ are the distances in centimetres of the polonium from the ionization chamber. Curves I., II., and III. were obtained when the maximum range of the alpha particle was 17.62 centimetres in hydrogen, helium, and air respectively.

Using the above described method, ionization curves were obtained in helium at normal pressure, hydrogen at a slightly reduced pressure, and air at a pressure of about 16.3 centimetres. Under these conditions the range of the alpha particle was the same for each gas. The curves obtained are shown in fig. 4. Curve I. was obtained in hydrogen, Curve II. in helium, and Curve III. in air. The area under the air curve is practically the same as that under the hydrogen curve. The area under the helium curve is about 5 per cent. greater than that under the hydrogen or air curve. Hence the ionization produced by an alpha particle is 5 per cent. more in helium than it is in hydrogen or air, and consequently the helium molecule is more readily ionized.

There is but little difference in the shape of the curves. The helium curve has a slightly more pronounced peak than the others, and this peak occurs a little nearer the end of the

range. The peak of the hydrogen curve is also nearer the end of the range than it is for the air curve, and it is also more pronounced. The formula given by Geiger*

$$I = \frac{c}{(r-x)^{\frac{1}{2}}}$$

for the ionization curve can be made to coincide very well with the curves by assuming 17 centimetres as the value of r , the average range of the particle. This theoretical curve varies more from the air curve than it does from either the hydrogen or helium curve.

From the results on the decrease in the number of particles from radium C near the end of the range in air or oxygen as compared with those for hydrogen or helium, it would seem probable that a greater difference should exist between the points at which the peaks of the curves occur than that shown by the curves in fig. 4.

Conclusions.

The ranges of the alpha particles from radium C and polonium have been determined by the scintillation method in helium, hydrogen, oxygen, and air.

The rate at which the number of alpha particles from radium C diminishes near the end of the range has been determined by the scintillation method in air, oxygen, hydrogen, and helium.

The Bragg ionization curve has been determined in helium and compared with the air and hydrogen curves obtained when the range of the particle was the same as that in helium. The ionization curve is of the general form

$$I = \frac{c}{(r-x)^{\frac{1}{2}}},$$

where I is the ionization; c a constant depending upon the energy required to produce an ion; r is the average range; and x the distance from the source of rays. The ratio of the total ionization in helium to that in air or hydrogen is 1.05.

I wish to express my thanks to Professor Rutherford for furnishing me the facilities for carrying out this research, and for his unfailing interest throughout the course of the work.

Physical Laboratories,
The University, Manchester,
May 10, 1913.

* Geiger, Proc. Roy. Soc. A. vol. lxxxiii. n. 565, p. 505.

XXXI. *Heating Effects at the Cathode in Vacuum Tubes.* By B. HODGSON, M.Sc., Ph.D., Assistant Lecturer in Physics, and P. A. MAINSTONE, B.Sc., The University, Bristol*.

§ 1. IT was known to the early experimenters in vacuum-tube work that the electrodes became heated during the discharge, and that the cathode became hotter than the anode. Plücker † called the negative electrode the Wärmepol, and Hittorf suggested that the big potential gradient near the cathode was the cause of the higher temperature. The first calorimetric measurements of the heat energy given to the cathode appear to have been made by Naccari and Bellati ‡ in 1878. They observed the proportionality between current and heat energy, and also the fact that the cathode received from 8 to 23 times as much heat as the anode. Granqvist § later verified the proportionality of current and cathode temperature; and one of the authors || measured in absolute units the heat energy communicated with various currents and gas pressures. This measurement led to the conclusion that only a small number of negative carriers took part in the discharge at the cathode surface.

§ 2. Apparatus.

This work was continued with improved apparatus and with electrodes of different metals in the gases oxygen, hydrogen, nitrogen, and air. The electrical arrangements were those described previously ¶. Two types of vacuum-tubes were used. The first is shown in fig. 1.

Fig. 1.

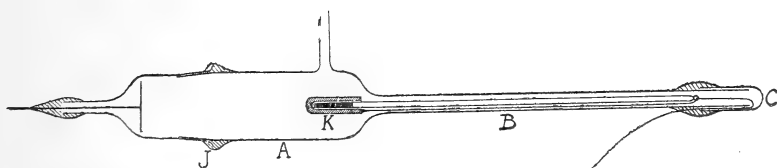

The tube A was made in two sections, fitting together by means of the ground-glass joint J. The cathode K consisted of a cylindrical cup, the cavity of which was of such a size

* Communicated by the Authors.

† Plücker, *Ann. d. Phys.* ciii. p. 90 (1858).

‡ Naccari and Bellati, *Beibl. d. Ann.* vol. ii. p. 720 (1878).

§ Granqvist, *Öfv. Kon. Vet.-Akad. Stockholm*, No. 43, p. 727 (1898).

|| Hodgson, *Phil Mag.* April 1913, p. 453.

¶ Hodgson, *loc. cit.*

as to admit the bulb of a sensitive mercury thermometer. The thermometer was completely enclosed in the tube B, the open end of which was closed by a glass cap C, and rendered airtight by means of picéin. A fine wire, which was soldered to the cathode, passed along the tube B, and enabled electrical connexion with the cathode to be made. The diameter of the tube was about 5 cm., and the distance separating the electrodes 14 cm.

In some later experiments a tube of the form shown in fig. 2 was used.

Fig. 2.

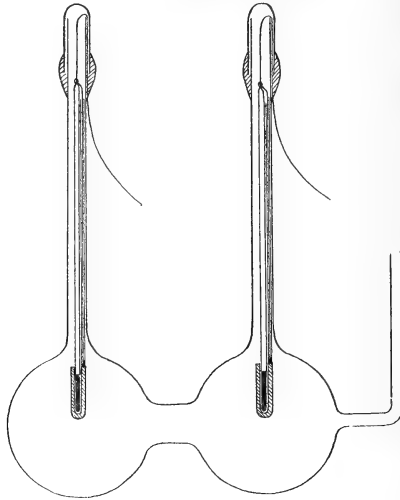

This consisted of two spherical bulbs each 11 cm. in diameter, in each of which could be fixed an electrode similar to the cathode of fig. 1. The thermometers were entirely enclosed in the vacuum-tube, and the leads in this case passed through glass tubes in order to confine the discharge to the electrode proper. With this form of apparatus there were two distinct advantages: firstly, the electrodes were fixed at some distance from the sides of the vacuum vessel, and so electrostatic disturbances of the field near the cathode were avoided; and secondly, the whole could be immersed in a water-bath, which allowed a more accurate observation of the equilibrium temperature to be made. The heat capacity of the cathode complete with thermometer and leads was obtained experimentally, using a modified form of Regnault's specific heat apparatus.

§ 3. Relation between current and heat energy given to the cathode in the case of the normal cathode glow.

It was shown* that there existed a linear relation between current and cathode temperature, and the statement made that if the rate of cooling of the cathode was proportional to its excess temperature, then a linear relation would exist between current and cooling-rate, that is, between current and heat energy supplied by bombarding ions. That this is true was verified in the following way. The current-temperature curve was obtained, and also the cooling-rates for the whole range of temperature involved. The value of the cooling-rate $\frac{d\theta}{dt}$ was plotted against current, and a straight line obtained. A few of these are shown in Curves I., II., and III. This is to be expected, for with the normal glow the only condition changing with an increase of current is the area of the cathode covered with glow; the cathode fall and the current density both remain constant.

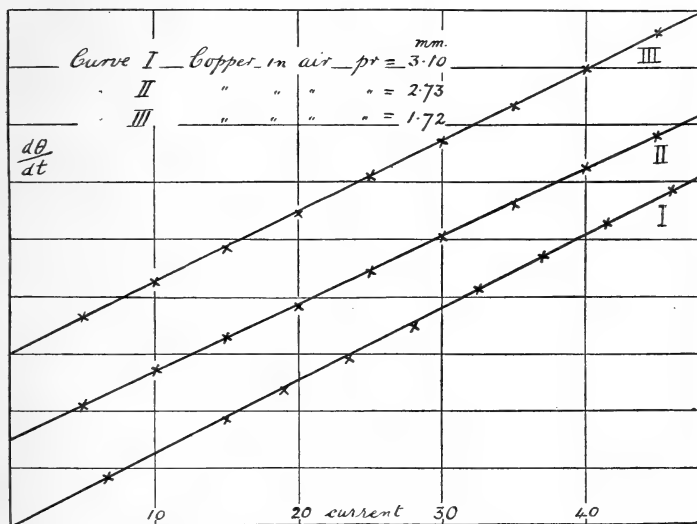

As soon as the cathode is covered with glow then both the cathode fall and current density increase. The cathode temperature was next investigated under these circumstances.

* Hodgson, *Phil. Mag.* April 1913, p. 454.

increased with pressure in hydrogen and helium with cathodes of aluminium, zinc, magnesium, and platinum. Warburg*,

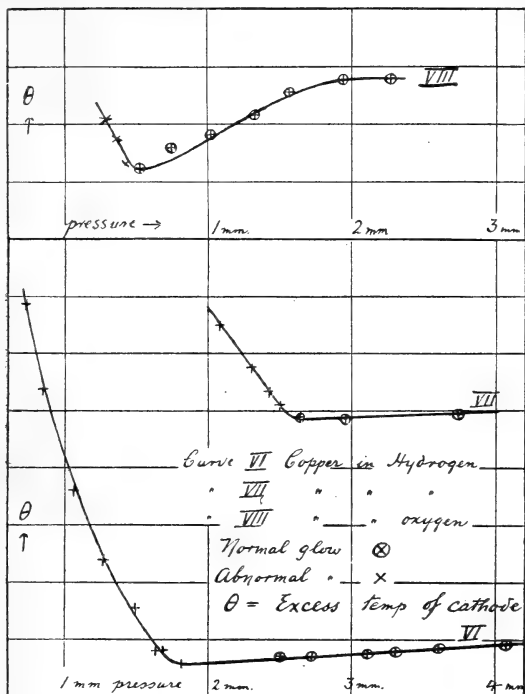

on the other hand, found it increasing with some electrodes and decreasing with others. In order to be certain that the effect was not due to difference in the rate of cooling, the energy communicated to the cathode was determined as in § 3.

The following results were obtained :—

TABLE I.
 Copper in Oxygen. (Normal glow.)

Pressure (mm. Hg.)	Energy (mean of 3). Units arbitrary.
3.09	146
2.64	146
2.12	142
1.63	141
1.34	139
1.04	128
0.83	126
0.60	120

* Warburg, *Ann. d. Phys.* xxxi. p. 11 (1887); xl. p. 570 (1890).

§ 5. *Absolute measurement of the heat energy given to the cathode with normal glow.*

The current was kept constant till the cathode took up that temperature at which the heat lost by radiation, &c., was equal to that supplied by the bombarding positive ions. The rate of cooling of the cathode was determined, and thus

$$M \cdot \frac{d\theta}{dt} \text{ could be obtained,}$$

where M = heat capacity of cathode,

$$\frac{d\theta}{dt} = \text{rate of cooling at the equilibrium temperature } \theta.$$

The quantities involved in the theoretical calculation of the heat energy given to the cathode are i the current and V the mean potential through which the bombarding ions fall.

If n positive ions strike the cathode per second, then neV is the energy communicated per second. Now if the current is carried entirely by positive ions $ne=i$ and the energy given up per second $=iV$.

The two quantities $M \frac{d\theta}{dt} = \alpha$, and $iV = \beta$ were obtained and the ratio α/β calculated, assuming V to be the normal cathode fall.

The maximum value that this ratio can assume is 1.0, when the current is carried by positive ions only (provided that no internal energy of the molecule is evolved as heat during the process of ionization). Should each positive ion in striking the cathode ionize and produce only one negative carrier, then the ratio 0.5 would result. If more than one negative carrier resulted from each collision, the value of the ratio would be still smaller.

Some work not yet published has shown that in the case of the anode the energy given up to it requires the negative carriers to gain energy in a path at least 1 cm. long in oxygen at a pressure of 2-4 mm. In this distance the ion collides often, and in order that its energy may still be given to the anode it is necessary that on collisions complex ions be formed. A neutral gas molecule bombarding the anode would merely recoil and give up no energy.

In the case of the cathode the same thing must hold, and the problem that presents itself is the question as to the length of path through which the positive carriers can accumulate energy. This is settled by our knowledge of the discharge in vacuum-tubes. The negative glow is the source of most

of the positive carriers, and there the electric field is very weak, and hence in the negative glow little energy can be acquired. So that the maximum energy a positive carrier can give up to the cathode is that obtained by its passing through the normal cathode fall. For this reason V was taken as the normal cathode fall.

§ 6. *Preparation of Gases.*

Experiments were performed in air, oxygen, hydrogen, and nitrogen.

The oxygen was prepared from pure potassium permanganate crystals. These were placed in a glass tube sealed on to the vacuum-tube. The whole was pumped out empty, and frequently washed out with gas before use.

Fig. 3.

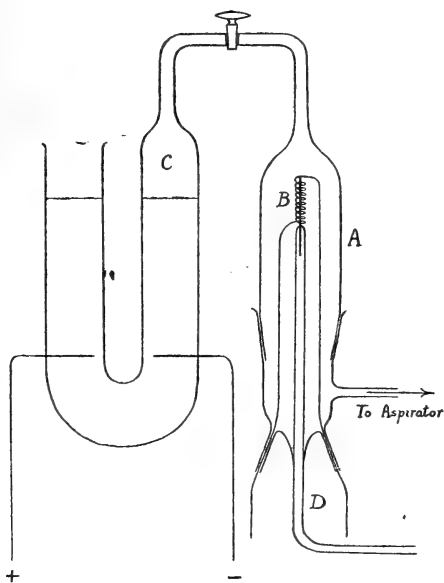

Hydrogen* was obtained by the electrolysis of water and purified in the following way. The hydrogen was prepared in the tube C (fig. 3) and admitted through a tap to the vessel A, previously evacuated by means of an aspirator. In this vessel was a palladium wire B sealed through the end of a tube D which was connected to the vacuum-tube,

* This method was seen in use in the Physical Institute of the University of Göttingen.

so that the palladium wire was in contact with both the space of the vessel A and that of the vacuum-tube. The wire was surrounded by a platinoid spiral that could be heated to redness by means of an electric current. When the palladium became sufficiently hot, pure hydrogen was absorbed and diffused through the wire into the vacuum-tube.

Nitrogen was prepared by heating crystals of ammonium dichromate in tubes sealed on to the apparatus. The substance breaks up violently in a vacuum, and it is necessary to seal on many tubes, each containing a small piece of the substance, if one wishes to avoid an explosive evolution of gas. On passing the discharge gases are evolved from the electrodes, and impurities so introduced can make enormous differences in the cathode fall. When this occurs it is necessary to wash out the apparatus again and refill with pure gas, repeating these processes till the evolution of gases ceases.

§ 7. Results in Oxygen and Hydrogen.

The following results were obtained :—

Metal—lead.

Gas—oxygen, $pr = 3.03$ mm.

$i = 0.00194$ amp.

$V^* = 370$ volts.

$\theta =$ cathode temperature $= 63^{\circ}.4$ C.

A = air „ „ $= 15^{\circ}.9$ C.

$\frac{d\theta}{dt} = \frac{4.67}{60}$ ($^{\circ}$ C. per sec.).

M = 2.20.

$M \frac{d\theta}{dt} = 2.20 \times \frac{4.67}{60} \times 4.18 \times 10^7$ ergs.

$= 7.15 \times 10^6$ ergs.

$iV = 0.00194 \times 370$ (amp. volts).

$= 7.18 \times 10^6$ ergs.

$\alpha/\beta = 0.995$.

The other results are given in brief.

* The values of the cathode fall in oxygen are taken from Thomson's 'Conduction through Gases,' 2nd edition, p. 560. For other gases the values are taken from the following paper, Rottgardt, *Ann. d. Phys.* xxxiii. p. 1161 (1911).

TABLE II.
Gas—Oxygen.

Cathode.	Gas pressure in mm.	$M \cdot \frac{d\theta}{dt}$.	iV .	α/β .
Cu	3.09	1.42	1.31	1.03
Pb	3.03	7.15	7.18	1.00
Pb	3.05	5.62	5.37	1.05
Ni	1.21	3.52	3.64	0.97
Ni	0.61	3.41	3.64	0.94
Ag	0.65	3.68	4.08	0.90
Ag	0.65	3.72	4.08	0.91

TABLE III.
Gas—Hydrogen.

Cathode.	Gas pressure in mm.	$M \cdot \frac{d\theta}{dt}$.	iV .	α/β .
Cu	3.16	1.03	1.03	1.00
Pb	3.63	5.44	5.36	1.01
Ni	2.48	8.75	7.73	1.13
Ni	2.48	8.83	8.01	1.10
Ni	1.92	9.33	8.88	1.05
Ag	2.38	9.86	8.55	1.15
Ag	2.13	9.94	8.85	1.12

In these two gases the value of α/β is approximately 1.0, so that the number of negative carriers taking part in the discharge is relatively small. If the normal cathode fall is the potential through which a positive ion must fall to gain energy sufficient to ionize the cathode metal*, then only those ions which pass through the dark space without a collision will ionize. This is a very small fraction of the total number bombarding the cathode, as can be seen by considering a special case. Consider the gas hydrogen at a pressure of 1 mm., with a cathode fall of about 400 volts, and a dark space 3.7 mm. in length. Now the mean free path of a hydrogen molecule at 1 mm. pressure is about 0.14 mm. at air temperature. So that in order to strike the cathode without a collision, the positive ion (if it is moving with a speed of the same order as the mean molecular speed) must pass through a distance 26 times its mean free path, and the probability of its performing this feat is extremely small. If its speed is great compared with the mean molecular speed, its mean free path becomes $\sqrt{2} \times 0.14$ mm., or 0.2 mm

* Stark, Winklemann's *Handbk. d. Phys.* Bd. iv. p. 516

that is only 1/18 of the length of the cathode dark space. The probability of passing this distance without a collision is still an extremely small quantity, and this would account for the ratio having the value 1·0.

§ 8. Results in Air and Nitrogen.

TABLE IV.

Gas—Air.

Cathode.	Gas pressure in mm. Hg.	$M \cdot \frac{d\theta}{dt}$.	iV .	α/β .	B.
Cu	3·10	1·20	1·00	1·20	1·38
Cu	2·73	1·18	1·00	1·18	1·38
Cu	2·19	1·13	1·00	1·13	1·38
Pb	3·03	7·30	4·02	1·82	1·79
Pb	3·06	5·29	3·00	1·76	1·79
Pb	1·80	1·19	0·81	1·46	1·79
Ni	0·55	3·23	2·03	1·59	1·47
Ni	0·55	3·44	2·26	1·52	1·47
Ag	0·87	4·13	3·49	1·18	1·33
Ag	0·80	4·13	3·49	1·18	1·33

TABLE V.

Gas—Nitrogen.

Cathode.	Gas pressure in mm. Hg.	$M \cdot \frac{d\theta}{dt}$.	iV .	α/β .	A.
Pb	3·75	7·60	5·15	1·48	1·76
Ni	2·34	4·08	2·56	1·59	1·68
Ni	1·35	3·53	2·47	1·42	1·68
Ag	1·68	4·06	2·56	1·58	1·59
Ag	2·28	4·67	3·03	1·54	1·59

It will be seen that in air and nitrogen the ratio has in general a value much higher than 1·0. The method of preparing nitrogen is not free from objection: the compound used contains oxygen, some of which is liberated with the nitrogen; and Warburg* has shown that a trace of oxygen has the effect of increasing considerably the cathode fall. The sixth column (Table V.) gives the ratio

$$\frac{\text{cathode fall in oxygen}}{\text{cathode fall in nitrogen}} = A,$$

which is the maximum value that α/β can assume under these circumstances. The value α/β in each case approaches the value A.

* Warburg, *Ann. d. Phys.* xl. p. 1 (1890).

There appears no good reason why the values in air should be above the value 1.0, yet they are invariably so. The column B (Table IV.) gives the ratio

$$\frac{\text{cathode fall oxygen}}{\text{cathode fall air}}$$

and apparently both in air and impure nitrogen the bombarding ions have passed through the oxygen cathode fall.

§ 9. As mentioned in § 6, the evolution of gas from the electrodes is a source of much impurity in the gases used. The effect of prolonged running of the tube was tried with lead and nickel cathodes in nitrogen. The following table gives the results:—

TABLE VI.
Nickel in nitrogen.

Exp.	a/β .	Notes.
1	1.59	N dry and fresh. Tube run only a short time.
2	1.34	Same gas used. Gas evolved.
3	1.25	Same gas used. Gas evolved.
4	1.35	Same gas used. Gas evolved.
5	1.25	Current run 3 hours before taking a reading.
6	1.59	Fresh, dry N let in.

TABLE VII.
Lead in nitrogen.

Exp.	a/β .	Notes.
1	1.48	Fresh dry nitrogen.
2	1.28	Gas absorbed.
3	1.16	Fresh nitrogen. Gas evolved.
4	1.10	Nascent sodium used. Gas absorbed.
5	1.08	Nascent sodium used. Gas absorbed.
6	0.98	Nascent sodium used. Gas absorbed.
7	1.32	Fresh N admitted, Gas evolved.
8	1.08	Nascent sodium used. Gas absorbed.

The value of the ratio diminishes as the tube becomes old, and also the use of nascent sodium* to absorb oxygen appears to have the same effect.

§ 10. These experiments seemed to point to the fact that the ratio α/β would invariably be 1.0 if the correct value of the cathode fall were used. The apparatus was then modified so that a sound could be moved into the negative glow, and the potential difference between the sound and the cathode measured. The following results were obtained:—

TABLE VIII.
Cathode—Lead.

Gas.	V measured.	V book value.
O	350	373
H	260	276
N	350	210
Air	290	207

The table shows clearly the reason for the deviation from 1.0 of the ratio α/β . For oxygen and hydrogen the values are approximately those given by Rottgardt and Thomson, but in air and nitrogen the values are quite different.

Experiments are being performed using the sound to measure the cathode fall simultaneously with $M \cdot \frac{d\theta}{dt}$, to determine more accurately the ratio α/β and to fix its deviation from the value 1.0.

Summary.

1. With normal glow the heat energy communicated to the cathode is proportional to the current.
2. When the abnormal glow sets in the heat given to the cathode increases more rapidly as the current increases.
3. The ratio α/β is approximately 1.0, showing that at the cathode surface only a few corpuscles are engaged in carrying the current.

The above work was done in the physical laboratory of the University of Bristol, and the authors' thanks are due to Dr. A. M. Tyndall for placing at their disposal the apparatus necessary for carrying out the work.

* Warburg, *Ann. d. Phys.* xl. p. 2 (1890).

XXXII. *On the Absorption of Light in Heterogeneous Media.*
By P. G. NUTTING*.

PHOTOGRAPHIC density depends upon the size and number of the imbedded silver grains and to a slight extent upon their form and distribution as well. The mathematical problem of relating density to grain is obviously to be treated by probability theory rather than by infinitesimal analysis. The solution here presented will be of interest to students of the theories of radiation and of entropy in discontinuous systems, in that it is a much simpler problem treated by similar probability methods.

Suppose snowflakes of a given size to be falling with perfect irregularity upon a surface. When a given number per unit area have fallen, what will be the mean relative areas covered and uncovered? In the plate grain problem as in the snowflake problem, the distribution is completely irregular, but in a volume instead of a plane. The grains are contained in a layer 10 to 20 μ thick and are themselves 0.5 to 3 μ in diameter, irregular in outline and fairly uniform in area in any one plate. The grains are not crystals, but aggregates of finely divided silver resembling platinum-black or soot, of very high absorbing and low reflecting power. This reflecting power has not yet been directly determined, but estimates based on scattering make it well under 2 per cent. In the following discussion both *reflexion* and *diffusion* are neglected, though both may be readily entered in the equations.

Consider the absorbing body divided into layers about one grain thick, parallel with the surface, so that there will be but a negligible amount of overlapping of grains in any one layer. That certain grains lie partly in two successive layers is of no consequence, since in the equations they are counted but once in the layer in which their greater bulk lies. In the first layer let there be n_1 grains per unit area and let a_1 be their average projected area. Then the probability of a ray of light being stopped by this layer is the ratio of the covered to the total area, or as $n_1 a_1$ to 1. Similarly the probability of a ray passing the first layer is $1 - n_1 a_1$. In other words, the absorption and transmission coefficients are respectively the probabilities of being stopped and of being passed.

In the second layer let the corresponding quantities be n_2 and a_2 , in the third n_3 and a_3 and so on. For brevity call the product $n_1 a_1 \equiv A_1$, &c. Now the only manner in which a

* Communicated by the Author.

ray may pass through all layers is to pass each layer separately, hence the probability of passing all layers is the continued product

$$(1-A_1)(1-A_2)\dots(1-A_m)\equiv T_m \quad . \quad . \quad (1)$$

of the probabilities of passing each separate layer. This is the *transparency* T_m of the whole sheet. The corresponding absorption B_m is the complementary quantity

$$B_m=1-T_m \quad . \quad . \quad . \quad . \quad . \quad (2)$$

It may be noted that the absorption of the whole is not the product $(A_1A_2\dots A_m)$ of the probabilities of absorption in the various layers since the action is not alike in all layers, a ray may be passed by several layers to be stopped in another. The above product $(A_1A_2\dots A_m)$ is the probability of possible stoppage in *all* layers, *i. e.* the probability per unit area of a continuous train of grains lying one behind the other, through all the successive m layers. In fact, if the value of T_m in (1) be written in (2), multiplied out and grouped according to the number of A 's multiplied together, then each group gives the probability of 2, 3 ... m grains overlapping.

In the special case of all layers alike in number and size of grain, the transparency of all m layers will be

$$T_m=(1-A)^m, \quad . \quad . \quad . \quad . \quad . \quad (3)$$

since in (1) $A_1=A_2=\dots=A_m$. This corresponds to *Beer's Law* in ordinary Optics.

Photographic density D has of late years been precisely defined by the relation

$$D=-\log_{10}T \quad . \quad . \quad . \quad . \quad . \quad (4)$$

T being the transparency in the sense used above. The value of T_m in either (1) or (3) may be substituted in (4) according to conditions. Equations (1) and (4) give the general relation sought between density and the number, size and distribution of grain.

In all ordinary practice the size and distribution of grain throughout the film is so uniform that (3) gives a very close approximation indeed. In this case

$$D=-m\log(1-A) \quad . \quad . \quad . \quad . \quad (5)$$

If further A is so small that the overlapping of grains is negligible, as is the case with low and medium densities,

$$D=mA=ma. \quad . \quad . \quad . \quad . \quad (6)$$

The ratio of the mass of reduced silver per unit area to the density (Δ) is an important quantity, the so-called *photographic constant*.

Now the film is m layers deep, hence $mn=N$ is the whole number of grains per unit area. Mass of silver (M) per unit area is then proportional to N and to the average volume of the grains,

$$M = cNa^{3/2}, \dots \dots \dots (7)$$

the constant c involving the specific gravity of the silver and certain numerical factors.

The photographic constant (P), defined as mass of silver per unit area per unit density, is then

$$P = \frac{M}{D} = \frac{cNa^{3/2}}{Na} = c\sqrt{a} \dots \dots \dots (8)$$

if the overlapping of grains is negligible, or is

$$P = - \frac{cNa^{3/2}}{\sum \log(1-na)} \dots \dots \dots (9)$$

without assumptions as to overlapping or uniformity of grain through the film.

From these equations it appears that P , to a first approximation, is independent of N and hence of exposure and development, but that it will vary among different brands of plates in proportion to the mean diameter of grain. The first of these conclusions is a well-known experimental fact. P is of the order 10 mg. of silver per square decimetre of film, per unit density. The relation between P and size of grain has not yet received experimental confirmation.

In the following table are numerical values calculated for different photographic densities.

D.	T.	1-A.	A.	10 A.
5	0.00001	0.316	0.684	6.8
3	0.001	0.501	0.499	5.0
2	0.010	0.631	0.369	3.7
1	0.100	0.794	0.206	2.1
0.7	0.200	0.851	0.149	1.5
0.5	0.316	0.891	0.109	1.1
0.2	0.631	0.955	0.045	0.45
0.1	0.794	0.977	0.023	0.23

T is the fraction of the light transmitted by the entire thickness of film, $1 - A$ is the corresponding transmission of any single layer one grain deep, while A is the fraction absorbed, on an average, in any single layer. The final column, $10 A$, is what the absorption of a film ten grains deep (an ordinary film) would be if each grain were fully effective. Thus, for unit density, the transparency is 10 per cent., the absorption of a single layer 20 per cent. and there are present 2.1 times as many grains as would completely cover a surface.

Taking the particular case of unit density and $A_1 = 20$ per cent. (0.20) and computing the absorption of the first n layers by the formula

$$B_{1\dots n} = 1 - T_n = 1 - (1 - A)^n,$$

$B_1 = A = 0.20$, $B_{12} = 2A - A^2 = 0.40 - 0.04 = 0.36$; that is, in the first two layers 36 per cent. is covered and 4 per cent. of this covered twice. In the first three layers,

$$B_{1\dots 3} = 3A - 3A^2 + A^3 = 0.60 - 0.12 + 0.008 = 0.488,$$

the probability of overlapping is 0.12, of triple overlapping of grains is 0.008. Tabulating for *ten* layers:—

n .	T_n .	B_n .	ΔB_n (%).	A^n .	nP_{10} .
1	0.794	0.206	—	0.214	2.06
2	0.633	0.367	16.1	0.04	1.80
3	0.501	0.499	13.2	0.008	0.96
4	0.398	0.602	10.3	0.0016	0.336
5	0.316	0.684	8.2	0.032	0.080
6	0.251	0.749	6.5	0.064	0.013
7	0.200	0.800	5.1	0.013	0.0017
8	0.159	0.841	4.1	0.026	0.0312
9	0.126	0.874	3.3	0.051	0.052
10	0.100	0.900	2.6	0.010	0.010

The second and third columns give respectively the *transparency* and *absorption* of the first n layers. The fourth column gives the increment of absorption due to the n th layer. The fifth column gives the probability of n grains overlapping in n layers. The last column gives the probability of n grains being in line in all ten layers, it is $A^n 10! / n! (10 - n)!$.

Rochester, N.Y.,
February, 1913.

XXXIII. *A Physical Interpretation of the Bessel Function of Zero Order.* By J. HOLLINGWORTH, M.A., B.Sc. (Eng.), A.C.G.I.*

THE Bessel function of zero order, regarded as the solution of the differential equation

$$\frac{d^2y}{dx^2} + \frac{1}{x} \frac{dy}{dx} + y = 0, \dots \dots \dots \text{I.}$$

is one which frequently occurs in certain branches of mathematical physics, and is of great importance.

Now such a solution can be regarded in two different ways, one of which has the claim of brevity and neatness, the other of more simple physical conception.

This is a wide and far-reaching difference, and depends on the point of view of the physicist towards mathematics.

The first point of view is as follows:—The fundamental equations derived from physical principles are found to give rise to a differential equation. This equation is then solved by purely formal mathematical methods, and the resulting solution re-interpreted into physical ideas and applied to the problem in question.

This is, no doubt, the simplest and shortest method, but it gives the impression that the physics are temporarily lost in the mathematics, and the physical process “taking place in the solution of the equation,” so to speak, is lost.

On the other hand we may proceed as follows. We may regard a complex problem as a generalization from the simple principles involved. These simple principles can be simply expressed mathematically, and consequently, by generalizing from these we should be able to build up the same solution to the problem as the one obtained by the first method, without using any process so apparently arbitrary as to write down a solution obtained by non-physical methods and say it is what we require. The two methods of course amount to the same thing, but to fully appreciate the first requires a good grasp of the logical connexion between mathematics and physics, and though of greater analytical power, is not of the same value for inductive reasoning on which at present physical work must largely depend.

In the present paper an attempt will be made to deduce the solution of a particular form of the equation I. by both methods so as to show their relative values.

The equation which will be considered is the special

* Communicated by the Author.

application to the electrical problem, and can be obtained as follows.

The general equations for the propagation of an electric disturbance in an isotropic medium can (*cf.* 'Recent Researches in Elec. and Mag.,' Sir J. J. Thomson, § 256) be reduced to the form

$$\nabla^2 P = \frac{4\pi\mu}{\sigma} \frac{dP}{dt} + \frac{1}{V^2} \frac{d^2 P}{dt^2}, \quad \dots \dots \dots \text{II.}$$

and two similar equations for Q and R,

where P, Q, and R are the components of electromotive intensity parallel to the axes and V the velocity of propagation of electric effects in the medium.

If the disturbance is propagated along the axis of z , R will be of the form

$$R e^{ipt+imz}.$$

Hence the corresponding equation reduces to

$$\frac{d^2 R}{dx^2} + \frac{d^2 R}{dy^2} - m^2 R = \frac{4\pi\mu ip}{\sigma} R - \frac{p^2}{V^2} R;$$

converting to polar coordinates this becomes

$$\frac{d^2 R}{dr^2} + \frac{1}{r} \frac{dR}{dr} + \frac{1}{r^2} \frac{d^2 R}{d\theta^2} = \frac{4\pi\mu ip}{\sigma} R - \frac{p^2}{V^2} R.$$

If, in addition, the system is symmetrical about the z axis

$$\frac{d}{d\theta} = 0 \quad \text{always.}$$

\therefore equation becomes

$$\frac{d^2 R}{dr^2} + \frac{1}{r} \frac{dR}{dr} = \frac{4\pi\mu ip}{\sigma} R - \frac{p^2}{V^2} R. \quad \dots \dots \dots \text{III.}$$

Now let us apply this to the case of two circular conducting plates separated by a slab of dielectric, the line joining the centres of the plates being perpendicular to their plane, and the oscillations propagated in this line. Then in the dielectric, equation III. reduces to]

$$\frac{d^2 R}{dr^2} + \frac{1}{r} \frac{dR}{dr} = \frac{1}{V^2} \frac{d^2 R}{dt^2}.$$

Assume the imposed oscillation harmonic in time,

i.e. write $R e^{ipt}$ for R ,

then this becomes

$$\frac{d^2R}{dr^2} + \frac{1}{r} \frac{dR}{dr} + k^2R = 0. \text{IV.}$$

This is the equation which will be considered.

Its solution is of course

$$AJ_0(ikr) + BY_0(ikr), \text{V.}$$

where J_0 and Y_0 have their usual significance, the constants A and B being determined by the necessary boundary conditions between the dielectric and the conducting plates.

A similar expression can be obtained for the currents in the dielectric and in the plates.

Now consider the same question from what may be called the "elementary" point of view.

Suppose we have two metal disks, situated as before, and between the middle points of them we connect a source of harmonic E.M.F.

Let V be the voltage, c the current at any point of one of the disks, say at a distance x from the centre. We now have an electric circuit containing resistance, inductance, leakage, and capacity, but these quantities are not constant at all points of the disk.

It will be easily seen that if their values at unit distance from the origin are represented respectively by R, L, G, K , their values at any other point are

$$R' = \frac{R}{x}, \quad L' = \frac{L}{x}, \quad G' = Gx, \quad K' = Kx.$$

Considering the change of voltage and current between any two adjacent points on a radius of the disk, we obtain the equations

$$\begin{aligned} -\frac{dc}{dx} &= K' \frac{dV}{dt} + G'V, \\ -\frac{dV}{dx} &= L' \frac{dc}{dt} + R'C. \end{aligned}$$

Substituting their values as above for $K' G' L' R'$ we get

$$\left. \begin{aligned} -\frac{dc}{dx} &= x \left\{ K \frac{dV}{dt} + GV \right\} \\ -\frac{dV}{dx} &= \frac{1}{x} \left\{ L \frac{dc}{dt} + RC \right\} \end{aligned} \right\} \text{VI.}$$

Eliminating C and V successively from these equations, we obtain the two equations

$$\left. \begin{aligned} \frac{d^2V}{dx^2} + \frac{1}{x} \frac{dV}{dx} &= LK \frac{d^2V}{dt^2} + (RK + LG) \frac{dV}{dt} + RGV, \\ \frac{d^2C}{dx^2} - \frac{1}{x} \frac{dC}{dx} &= LK \frac{d^2C}{dt^2} + (RK + LG) \frac{dC}{dt} + RGC. \end{aligned} \right\} \text{VII.}$$

If, as before, we assume the oscillations to be periodic in time and of form $V e^{ipt}$, the equations VII. reduce to

$$\left. \begin{aligned} \frac{d^2V}{dx^2} + \frac{1}{x} \frac{dV}{dx} &= \{ -LKp^2 + (RK + LG)ip + RG \} V \\ \frac{d^2C}{dx^2} - \frac{1}{x} \frac{dC}{dx} &= \{ \hspace{15em} \} C \end{aligned} \right\} \text{VIII.}$$

and these equations give rise to a solution similar in form to that of equation IV.

This is the solution of the problem according to the first method mentioned at the beginning of the paper.

Now to consider the same question from another point of view.

It is a well-recognized fact that if we have a wave travelling in any homogeneous medium, at the surface of separation of two such media whose physical constants differ the wave is partially refracted and partially reflected.

If the change in these constants is only of the first order, it appears probable that the amplitude of the reflected wave is not greater than a first-order quantity, and that the amplitude of the transmitted wave will be reduced by a quantity of the same order.

Applying this idea to the disk it suggests that at every point there is such refraction and reflexion taking place. The resultant wave will therefore consist of

- (i.) the original impressed wave ;
- (ii.) the sum of a number of first-order reflected waves due to the changes all along the wire ;
- (iii.) the totally reflected wave (if the length of wire is finite) ;
- (iv.) a forward travelling wave consisting of first order reflexions of (iii.).

No further first order reflexions will be found to occur, as it will be found that second reflexions give a wave with an amplitude of the second order.

If the length of the wire is infinite (iii.) and (iv.) will be non-existent, but it is important to note that the resultant waves will still contain a term involving reflected waves, and arising from (ii.). This is the important point in which the waves propagated along such a wire differ from those along a uniform wire.

It will now be shown that proceeding on this assumption, by the use of the ordinary methods for obtaining the refraction and reflexion of simple sine waves, an equation of the form of VIII. will again be reached, showing that we have obtained a correct representation (within the limits of the theory) of what is actually occurring in the wire at any instant.

Consider a sine wave of voltage travelling along the axis of x in the positive direction.

It will be of the form

$$V = A e^{i(pt-ax)} \quad (\text{real part}).$$

At the point $x = X$ let L, K, R, G change to L', K', R', G' .

The refracted wave will be of the form

$$V = A_1 e^{i(pt-a'x)} \quad (\text{real part}),$$

and reflected wave will be

$$V = A' e^{i(pt+ax)} \quad (\text{real part}).$$

At the surface of separation both current and voltage must be continuous for all values of the time :

$$\therefore A e^{-iaX} + A' e^{iaX} = A_1 e^{-ia'X}, \dots \dots \dots (1)$$

for continuity of voltage.

Again equations VI., p. 429, must also be satisfied,

$$\therefore -\frac{dc}{dx} = e^{ipt} \{Kip + G\} \{A e^{-iax} + A' e^{iax}\},$$

$$\therefore c = \frac{e^{ipt}}{a} \{Kip + G\} \{A e^{-iax} - A' e^{iax}\};$$

\therefore for continuity of current

$$\frac{Kip + G}{a} \{A e^{-iaX} - A' e^{iaX}\} = \frac{K'ip + G'}{a'} A_1 e^{-ia'X}. \dots (2)$$

Also

$$\frac{(Kip + G)(Lip + R)}{a^2} = \frac{(K'ip + G')(L'ip + R')}{a'^2} = -1. \dots (3)$$

Hence, in general, we have equations (1), (2), and (3) to determine A', A_1 , and a .

Now for present considerations X represents a fixed point on the wire, and therefore X is a constant.

Put \therefore KX for K, $K(X+dX)$ for K',
 $G X$,, G, $G(X+dX)$,, G',
 $\frac{R}{X}$,, R, $R/(X+dX)$,, R',
 $\frac{L}{X}$,, L, $L/(X+dX)$,, L'.

Then the new values of K L R G are all constants if dX is specified beforehand.

Also, referring to equation (3), we get

$$\begin{aligned} & (K'ip + G')(L'ip + R') \\ &= \frac{(Kip + G)(X + dX)(Lip + R)}{X + dX} \\ &= (Kip + G)(Lip + R), \end{aligned}$$

\therefore in this case $a = a'$,

i. e. the velocity of propagation of the disturbance is the same in both portions of the wire.

Equations (1) and (2) now become

$$Ae^{-iaX} + A'e^{iaX} = A_1e^{-iaX}, \dots \dots \dots (4)$$

$$X(Kip + G)(Ae^{-iaX} - A'e^{iaX}) = A_1e^{-iaX}(X + dX)(Kip + G),$$

i. e. $Ae^{-iaX} - A'e^{iaX} = A_1e^{-iaX} \cdot \left\{ 1 + \frac{dX}{X} \right\}, \dots (5)$

solving (4) and (5) for A' and A₁ in terms of A

$$A' = -Ae^{-2iaX} \frac{dX}{2X}, \dots \dots \dots (6)$$

$$A_1 = A \left(1 - \frac{dX}{2X} \right). \dots \dots \dots (7)$$

Hence when the forward wave reaches the point X, a wave of amplitude $Ae^{-2iaX} \frac{dX}{2X}$ is reflected back, and one of amplitude $A \left(1 - \frac{dX}{2X} \right)$ goes forward.

Of course, throughout the whole calculation only the real portion of the original expression

$$Ae^{i(pt \pm ax)} \text{ is taken,}$$

and hence, since a is complex, A is also complex, and

consequently gives the change of phase as well as the amplitude. Hence for a series of waves the sum of the A's will give the true amplitude and phase position of the resultant wave.

Now to consider the reflected wave, *i. e.* the main wave travelling towards the origin.

In the portion of the wire beyond the change the incident wave is of the form

$$Be^{i(pt+ax)},$$

the reflected wave of the form

$$B'e^{i(pt-ax)},$$

and the refracted wave of form

$$B_1e^{i(pt+ax)}, \quad (\text{real part}).$$

Constructing the equations corresponding to (4) and (5) we have

$$Be^{iaX} + B'e^{-iaX} = B_1e^{iaX}, \quad \dots \dots \dots (8)$$

$$\begin{aligned} Be^{iaX} - B'e^{-iaX} &= B_1e^{iaX} \frac{X}{X+dX} \\ &= B_1e^{iaX} \left\{ 1 - \frac{dX}{X} \right\}. \quad \dots \dots \dots (9) \end{aligned}$$

Solving for B' and B₁ in terms of B, we get

$$B' = Be^{2iaX} \frac{dX}{2X}, \quad \dots \dots \dots (10)$$

$$B_1 = B \left(1 + \frac{dX}{2X} \right). \quad \dots \dots \dots (11)$$

Now combine the results of equations (6), (7), (10), (11), tabulating for clearness as follows.

$$x = X$$

Portion of wire corresponding to K=KX.	Portion of wire corresponding to K=K(X+dX).
Original incident wave A →	Refracted wave A $\left(1 - \frac{dX}{2X}\right)$ →
Reflected wave $-Ae^{-2iaX} \frac{dX}{2X}$ ←	Incident wave B ←
Refracted wave B $\left(1 + \frac{dX}{X}\right)$ ←	Reflected wave $Be^{2iaX} \frac{dX}{2X}$ →
giving	giving
A →	← B
$B + \frac{BdX}{2X} - Ae^{-2iaX} \frac{dX}{2X}$ ←	$A \left(1 - \frac{dX}{2X}\right) + Be^{2iaX} \frac{dX}{2X} \rightarrow = A'$ say.

The above being the case when waves in both directions are originally incident.

Now at a point dX further on let the constants of the wire change again

from $K(X+dX)$ to $K(X+2dX)$ and similarly.

Another series of reflexions and refractions, similar to those already calculated, occur.

Repeating this process we can divide the length of wire between $x=\alpha$ and $x=\beta$ into n equal portions dX , and then the following relations will hold between the amplitudes of the waves in successive portions :—

$$A_{s+1} = A_s - \frac{A_s dX}{2X} + \frac{B_s e^{2iaX} dX}{2X},$$

.

$$B_s = B_{s+1} + \frac{B_{s+1} dX}{2X} - A_s e^{-2iaX} \frac{dX}{2X},$$

$$A_{s+1} - A_s = -A_s \frac{dX}{2X} + B_s \frac{e^{2iaX} dX}{2X}, \quad . \quad (12)$$

$$B_s - B_{s+1} = \frac{B_{s+1} dX}{2X} - A_s \frac{e^{-2iaX} dX}{2X}; \quad . \quad (13)$$

(12) and (13) being in sequence form, we can, by addition, find the relation between any pair of A's and any pair of B's.

Now let n become infinitely large, and therefore dX small, and effect the summation from $x=\alpha$ to $x=x$, (12) and (13) then give

$$A_x - A_\alpha = - \int_\alpha^x \frac{A_\xi d\xi}{2\xi} + \int_\alpha^x B_\xi \frac{e^{2ia\xi} d\xi}{2\xi}, \quad . \quad (14)$$

and for the B's

$$B_x - B_\alpha = \int_\alpha^x \frac{B_\xi d\xi}{2\xi} - \int_\alpha^x A_\xi \frac{e^{-2ia\xi} d\xi}{2\xi}. \quad . \quad (15)$$

$A_\alpha B_\alpha$ being the amplitudes of the forward and reflected waves at the point $x=\alpha$, and therefore constants for the particular value of x involved.

Hence, if we can solve equations (14) and (15) for A_x and B_x , we have the amplitudes of the forward and reflected waves at any point x on the wire for which

$$K = K'x \quad L = \&c.,$$

i. e. for the disk considered on p. 429.

The complete wave at any point is, therefore, the real part of $e^{ipt} \{A_x e^{-iax} + B_x e^{iax}\}$.

Now to solve equations (14) and (15).

Differentiating both with regard to x , (14) gives (neglecting subscripts to A and B)

$$\frac{dA}{dx} = -\frac{A}{2x} + \frac{B e^{2iax}}{2x} \quad \dots \quad (16)$$

$$\frac{dB}{dx} = \frac{B}{2x} - \frac{A e^{-2iax}}{2x} \quad \dots \quad (17)$$

Differentiate (16) and (17) with regard to x ,

$$\frac{d^2A}{dx^2} + \frac{1}{2x} \frac{dA}{dx} - \frac{A}{2x^2} = \frac{e^{2iax}}{2x} \cdot \frac{dB}{dx} + B \left\{ \frac{2ia}{2x} - \frac{1}{2x^2} \right\} e^{2iax} \quad (18)$$

$$\frac{d^2B}{dx^2} - \frac{1}{2x} \frac{dB}{dx} + \frac{B}{2x^2} = -\frac{e^{-2iax}}{2x} \frac{dA}{dx} - A e^{-2iax} \left\{ \frac{-2ia}{2x} - \frac{1}{2x^2} \right\}; \quad \dots \quad (19)$$

eliminating B and $\frac{dB}{dx}$ from (18) by means of (16) and (17)

$$\begin{aligned} \frac{d^2A}{dx^2} + \frac{1}{2x} \frac{dA}{dx} - \frac{A}{2x^2} &= \frac{e^{2iax}}{2x} \left\{ \frac{B}{2x} - \frac{A e^{-2iax}}{2x} \right\} \\ &+ e^{2iax} \left\{ \frac{2ia}{2x} - \frac{1}{2x^2} \right\} \left\{ \frac{dA}{dx} + \frac{A}{2x} \right\} \times 2x e^{-2iax} \\ &= -\frac{A}{4x^2} + \left(2ia - \frac{1}{x} \right) \left(\frac{dA}{dx} + \frac{A}{2x} \right) + \frac{1}{2x} \left(\frac{dA}{dx} + \frac{A}{2x} \right) \end{aligned}$$

i. e.
$$\frac{d^2A}{dx^2} - \frac{dA}{dx} \left(2ia - \frac{1}{x} \right) - \frac{iaA}{x} = 0; \quad \dots \quad (20)$$

similarly eliminating A from (16), (17), (19),

$$\begin{aligned} \frac{d^2B}{dx^2} - \frac{1}{2x} \frac{dB}{dx} + \frac{B}{2x^2} &= \frac{e^{-2iax}}{2x} \left\{ -\frac{A}{2x} + \frac{B e^{2iax}}{2x} \right\} \\ &- \frac{e^{-2iax}}{2x} \left\{ -2ia - \frac{1}{x} \right\} \left\{ -\frac{dB}{dx} - \frac{B}{2x} \right\} 2x e^{2iax} \\ &= \frac{B}{4x^2} + \left(2ia + \frac{1}{x} \right) \left(-\frac{dB}{dx} - \frac{B}{2x} \right) + \frac{1}{2x} \left(-\frac{dB}{dx} - \frac{B}{2x} \right) \end{aligned}$$

i. e.
$$\frac{d^2B}{dx^2} + \left(2ia + \frac{1}{x} \right) \frac{dB}{dx} + \frac{iaB}{x} = 0. \quad \dots \quad (21)$$

(20) and (21) are the two differential equations to determine A and B.

Now put

$$\begin{aligned} A e^{-iax} &= t \\ B e^{iax} &= t'. \end{aligned}$$

Then the complete wave is of form:—

$$\text{real part of } (t + t') e^{ipt}.$$

Now substitute t for A in (20)

$$\begin{aligned} A &= e^{iax} t, \\ \therefore \frac{dA}{dx} &= e^{iax} \left(\frac{dt}{dx} + iat \right) \\ \frac{d^2A}{dx^2} &= e^{iax} \left(\frac{d^2t}{dx^2} + 2ia \frac{dt}{dx} - a^2t \right), \end{aligned}$$

i. e. (20) becomes (after dividing by e^{iax})

$$\frac{d^2t}{dx^2} + 2ia \frac{dt}{dx} - a^2t - \left(2ia - \frac{1}{x} \right) \left(\frac{dt}{dx} + iat \right) - \frac{iat}{x} = 0,$$

$$*i. e.* \quad \frac{d^2t}{dx^2} + \frac{1}{x} \frac{dt}{dx} + a^2t = 0. \quad \dots \dots (22)$$

Again substitute $B = e^{-iax} t'$ in (21),

$$\begin{aligned} \frac{dB}{dx} &= e^{-iax} \left\{ \frac{dt'}{dx} - iat' \right\} \\ \frac{d^2B}{dx^2} &= e^{-iax} \left\{ \frac{d^2t'}{dx^2} - 2ia \frac{dt'}{dx} - a^2t' \right\}, \end{aligned}$$

therefore (21) becomes

$$\frac{d^2t'}{dx^2} - 2ia \frac{dt'}{dx} - a^2t' + \left(2ia + \frac{1}{x} \right) \left(\frac{dt'}{dx} - iat' \right) + \frac{iat'}{x} = 0,$$

$$*i. e.* \quad \frac{d^2t'}{dx^2} + \frac{1}{x} \frac{dt'}{dx} + a^2t' = 0, \quad \dots \dots (23)$$

which is of the same form as (22).

Therefore $t + t'$ satisfies an equation of the form

$$\frac{d^2y}{dx^2} + \frac{1}{x} \frac{dy}{dx} + a^2y = 0,$$

$$*i. e.* \quad \frac{d^2y}{dx^2} + \frac{1}{x} \frac{dy}{dx} = (Kip + G)(Lip + R)y, \quad \dots (24)$$

from equation (3), p. 431.

But this is the same equation as VIII., p. 430. Hence it has been shown that the wave obtained as a solution of the equations (14) and (15) is identical in form with the wave obtained by the original method. Certain assumptions have, in the course of the work, been tacitly made.

(1) The disk does not extend to the origin, for then terms of the form $\frac{e^{\pm 2iax}}{x}$ would become infinite. This is equivalent to the fact that in a simple circuit radiation can only take place from an open end.

(2) That either the disks are infinite in size, or that the distance between them is small compared with the wavelength, *i. e.* that the entire radiation from one plate reaches the other.

For, in the case where R and G are zero, *i. e.* the system consists of perfect conductors immersed in a perfect dielectric, equation (24) becomes

$$\frac{d^2y}{dx^2} + \frac{1}{x} \frac{dy}{dx} + KLp^2y = 0,$$

the solution of which is

$$y = AJ_0(\sqrt{KL} \cdot px) + BY_0(\sqrt{KL}px),$$

i. e. voltage is real part of

$$\{AJ_0(\sqrt{LK}px) + BY_0(\sqrt{KL}px)\} e^{ipt}. \quad (25)$$

Now since for a particular case voltage must be given both in amplitude and phase at one particular point, and also current, therefore A and B may be taken as real. Therefore from equation VI., p. 429,

$$\begin{aligned} \frac{L}{x} \frac{dc}{dt} &= \left\{ -AJ_0'(\sqrt{KL}px) - BY_0'(\sqrt{KL}px) \right\} \sqrt{KL} e^{ipt} \\ &= \left\{ AJ_1(\sqrt{KL}px) + BY_1(\sqrt{KL}px) \right\} \sqrt{KL} e^{ipt} \\ \therefore c &= ix \sqrt{\frac{K}{L}} \left\{ AJ_1(\sqrt{KL}px) + BY_1(\sqrt{KL}px) \right\} e^{ipt}. \\ & \dots \dots \dots (26) \end{aligned}$$

Comparing (25) and (26), we see that at all points current and voltage are 90° out of phase, and hence there is no loss of power, *i. e.* in this case radiation with outside space is zero.

If R and G are not zero terms of the form $J_{0\sqrt{Kip+G}} x$ will occur in the solution which are complex, and so give rise to a change of phase, and therefore to a loss of power in ohmic resistance.

It may be of interest, however, to see how far the solution by elementary methods corresponds with the case in which a single conducting plate in an infinite dielectric is considered.

Radiation losses will now of course occur. (The following analysis is chiefly deduced from the results in Macdonald's 'Electric Waves,' § 57 *sqq.*)

For the general case of an infinite cone with oscillations of a form to give rise to circles of magnetic force with their centres on the axis of the cone, we have

$$\psi = -q \sum \left(\frac{r}{r_1}\right)^{\frac{1}{2}} J_{n+\frac{1}{2}}(Kr_1) \left\{ J_{-n-\frac{1}{2}}(Kr_s) - e^{(n+\frac{1}{2})\pi i} J_{n+\frac{1}{2}}(Kr) \right\} \\ \times \frac{\pi}{N \sin(n+\frac{1}{2})\pi} \sin \theta_1 \frac{\partial P_n}{\partial \mu_1} (1-\mu^2) \frac{\partial P_n}{\partial \mu},$$

the sources being given in position by $r=r_1$, $\theta=\theta_1$ ($r_1 < r$), summation being for all values of n for which $P_n(\mu_0)=0$ (Macdonald, § 62).

In the case of the plane $\theta_0 = \frac{\pi}{2}$ this reduces to

$$-q \sum \left(\frac{r}{r_1}\right) J_{n+\frac{1}{2}}(Kr_1) \left\{ J_{-n-\frac{1}{2}}(Kr) - e^{(n+\frac{1}{2})\pi i} J_{n+\frac{1}{2}}(Kr) \right\} \\ \times \frac{\pi}{N \sin(n+\frac{1}{2})\pi} \sin \theta_1 \frac{\partial P_n}{\partial \mu_1} \frac{\partial P_n}{\partial \mu}, \dots \quad (27)$$

n being any odd integer.

r_1 small and $\theta_1 = 90^\circ$ give case of small circle of sources inside small hole in centre of disk.

$$\text{Now } J_{n+\frac{1}{2}}(x) = x^{n+\frac{1}{2}} \sum_0^\infty \frac{(-1)^s x^{2s}}{2^{n+\frac{1}{2}+2s} \pi(s) \pi(n+\frac{1}{2}+s)},$$

i. e. since quantity under summation is finite largest term is given by $n=1$, all others being negligible in comparison.

Therefore (27) reduces to

$$-q \left(\frac{r}{r_1}\right)^{\frac{1}{2}} \frac{(Kr_1)^{\frac{3}{2}}}{2^{\frac{3}{2}} \pi(\frac{3}{2})} \left\{ J_{-\frac{3}{2}}(Kr) + i J_{\frac{3}{2}}(Kr) \right\} \frac{\pi \cdot 3}{2} \sin \theta,$$

since $\frac{\partial P_1}{\partial \mu} = 1$ for all values of μ

$$= \frac{-qr_1 K^{\frac{3}{2}} \cdot \sqrt{r} \cdot \pi}{2^{\frac{3}{2}} \cdot \frac{1}{2} \sqrt{\pi}} \left\{ J_{-\frac{3}{2}}(Kr) + i J_{\frac{3}{2}}(Kr) \right\} \sin \theta, \quad (28)$$

and since as size of circle of sources is diminished, strength must be increased to keep effect finite, qr_1 is finite = A say, where A involves time factor

$$\therefore \psi = \frac{AK^{\frac{3}{2}}\sqrt{\pi r}}{\sqrt{2}} \left\{ J_{-\frac{3}{2}}(Kr) + iJ_{\frac{3}{2}}(Kr) \right\} \sin \theta.$$

Again (Macdonald, § 36)

$$4\pi v = \frac{1}{r \sin \theta} \frac{\partial \psi}{\partial r},$$

therefore in dielectric

$$\frac{1}{V^2} \cdot \frac{\partial Y}{\partial t} = 4\pi v = \frac{1}{r \sin \theta} \frac{\partial \psi}{\partial r}.$$

$$\therefore \frac{\partial Y}{\partial t} = \frac{AK^{\frac{3}{2}}}{\sqrt{2}} \frac{\partial}{\partial r} \left\{ J_{-\frac{3}{2}}(Kr) + iJ_{\frac{3}{2}}(Kr) \right\} \sqrt{\pi r}, \quad (29)$$

but

$$J_{\frac{3}{2}}(Kr) = \frac{1}{\sqrt{\frac{\pi Kr}{2}}} \left(\frac{\sin Kr}{Kr} - \cos Kr \right),$$

and

$$J_{-\frac{3}{2}}(Kr) = \frac{1}{\sqrt{\frac{\pi Kr}{2}}} \left(-\sin Kr - \frac{\cos Kr}{Kr} \right),$$

therefore (29) reduces to

$$\begin{aligned} \frac{1}{V^2} \frac{\partial Y}{\partial t} &= \frac{A\sqrt{K}}{r} \cdot \frac{\partial}{\partial r} \left\{ \frac{i \sin Kr}{Kr} - i \cos Kr - \sin Kr - \frac{\cos Kr}{Kr} \right\} \\ \frac{\partial Y}{\partial t} &= \frac{V^2 A \sqrt{K}}{r} \left\{ -K \cos Kr + iK \sin Kr + \frac{K \sin Kr}{Kr} + \frac{iK \cos Kr}{Kr} \right. \\ &\quad \left. - \frac{i \sin Kr}{K^2 r^2} + \frac{\cos Kr}{K^2 r^2} \right\} \\ &= \frac{V^2 AK^{\frac{3}{2}}}{r} \left\{ -\cos Kr + \frac{\sin Kr}{Kr} + \frac{\cos Kr}{K^2 r^2} + i \left(\sin Kr + \frac{\cos Kr}{Kr} \right. \right. \\ &\quad \left. \left. - \frac{\sin Kr}{K^2 r^2} \right) \right\}, \end{aligned}$$

from which we see that amplitude of oscillation of normal electric force at any point in the dielectric close to the disk is

$$\frac{V^2 AK^{\frac{3}{2}}}{r} \left\{ 1 - \frac{1}{K^2 r^2} + \frac{1}{K^4 r^4} \right\}^{\frac{1}{2}} \dots \quad (30)$$

Hence, at a considerable distance from the centre amplitude

is $\frac{V^2 AK^{\frac{3}{2}}}{r}$, this being where $\frac{1}{Kr}$ is small.

Now returning to equation (25), if plate extends to infinity V must be zero when x is infinite,

$$i. e. \quad V = A\{(\gamma - \log 2) J_0(p\sqrt{KL}x) + Y_0(p\sqrt{KL}x)\}.$$

Hence, when x is large, but not infinite,

$$V = \frac{A\sqrt{\pi}}{\sqrt{\{2\sqrt{(KL)}\rho x\}}} \sin\left(\frac{\pi}{4} - \sqrt{(KL)}\rho x\right). \quad (31)$$

Hence, comparing (30) and (31), we see that at large distances from the origin on the elementary theory, the amplitude of the oscillation is inversely proportional to the square root of the distance, and when radiation is taken into account, inversely proportional to the distance.

In conclusion I must express my thanks to Prof. Howe, of the City and Guilds (Eng.) College, to whom I am indebted, both for the suggestion of the original problem which led to the deductions in the paper, and also for many helpful criticisms in the course of the work.

XXXIV. *On Plane Waves of Sound.* By J. R. WILTON, M.A., B.Sc., Assistant Lecturer in Mathematics in the University of Sheffield*.

1. IT is well known that the exact equation for plane waves of sound leads to a result which cannot hold beyond a certain time, owing to the fact that the motion becomes discontinuous †. The proof given in the text-books depends on Earnshaw's solution of the equation of motion, which assumes a relation between the velocity and the rate of variation of the displacement with the position. There does not seem to be any reason for this relation, and the fact of discontinuity does not depend upon it. The following paper was undertaken with a view to discovering when discontinuity sets in in any given case, the initial displacement and velocity being arbitrarily assigned. Incidentally it will be shown that the ordinary approximate solution, in which the displacement is regarded as a small quantity whose square may be neglected, does not begin to depart widely from the truth until the

* Communicated by the Author.

† See, for example, Lord Rayleigh's 'Sound,' 2nd edit. vol. ii. p. 36.

motion approaches the stage in which it becomes discontinuous.

2. We take the equation of motion in Earnshaw's form, using the notation of equation (4), paragraph 249, of Lord Rayleigh's 'Sound,' namely,

$$\left(\frac{\partial y}{\partial x}\right)^{\gamma+1} \frac{\partial^2 y}{\partial t^2} = a^2 \frac{\partial^2 y}{\partial x^2}, \quad \dots \dots \dots (1)$$

where $a^2 = p_0 \gamma / \rho_0$, and γ is the ratio of the specific heats.

The general solution of equation (1) may be put in various forms, of which one is the envelope of the plane (x, t, y being the current coordinates):

$$px + qt - y = p^{\frac{3}{2}} \sum_{n=1}^{\infty} \left\{ A_n J_{\frac{1}{\gamma-1}} \left(\frac{2na}{\gamma-1} p^{-\frac{\gamma-1}{2}} \right) + B_n J_{-\frac{1}{\gamma-1}} \left(\frac{2na}{\gamma-1} p^{-\frac{\gamma-1}{2}} \right) \right\} \cos(nq + c_n),$$

where p and q are considered as variable parameters, and A_n, B_n, c_n are constants.

The form of this solution shows that when $1/(\gamma-1)$ is the half of an odd integer, *e. g.* $\gamma=1.4$, the solution will be expressible in finite terms.

We proceed to derive the solution, in the particular case mentioned, in a form which will be more immediately useful. First, by Legendre's transformation (The Principle of Duality), we obtain

$$p^{\gamma+1} \frac{\partial^2 u}{\partial p^2} = a^2 \frac{\partial^2 u}{\partial q^2},$$

where

$$p = \frac{\partial y}{\partial x}, \quad q = \frac{\partial y}{\partial t}, \quad u = px + qt - y.$$

Putting $u = pv$, the equation becomes

$$p^{\gamma+1} \frac{\partial^2 v}{\partial p^2} + 2p^\gamma \frac{\partial v}{\partial p} = a^2 \frac{\partial^2 v}{\partial q^2},$$

and, finally, putting

$$\xi = \frac{2a}{\gamma-1} p^{-\frac{\gamma-1}{2}} + q, \quad \eta = \frac{2a}{\gamma-1} p^{-\frac{\gamma-1}{2}} - q,$$

we have

$$\frac{\partial^2 v}{\partial \xi \partial \eta} = \frac{3-\gamma}{2(\gamma-1)} \frac{\partial v}{\partial \xi} + \frac{\partial v}{\partial \eta} \dots \dots \dots (2)$$

3. In the particular case when $\gamma=1.4$, its approximate value, equation (2) becomes

$$\frac{\partial^2 v}{\partial \xi \partial \eta} = 2 \frac{\left(\frac{\partial v}{\partial \xi} + \frac{\partial v}{\partial \eta}\right)}{\xi + \eta}, \dots \dots \dots (3)$$

and in this form it may be solved by Darboux' method, and—though with so much labour as to make it impracticable—the solution corresponding to any initial conditions may be obtained. Each set of characteristics, with the above value of γ , has two integrable combinations, namely,

$$\begin{aligned} d\xi &= 0, & d\eta &= 0, \\ d\alpha &= 2\alpha d\eta/(\xi + \eta), & d\delta &= 2\delta d\eta/(\xi + \eta); \end{aligned}$$

whence

$$\alpha = (\xi + \eta)^2 \phi^V(\xi), \dots \dots \dots (4)$$

$$\delta = (\xi + \eta)^2 \psi^V(\eta), \dots \dots \dots (5)$$

where ϕ and ψ are arbitrary functions of their arguments, and $\alpha, \beta, \gamma, \delta$ are the partial derivatives of the third order. ϕ^V, ψ^V denote the fifth differential coefficients of their arguments. The general solution of equation (3) is therefore

$$\begin{aligned} v &= (\xi + \eta)^2 \phi''(\xi) - 6(\xi + \eta)\phi'(\xi) + 12\phi(\xi) \\ &+ (\xi + \eta)^2 \psi''(\eta) - 6(\xi + \eta)\psi'(\eta) + 12\psi(\eta). \dots (6) \end{aligned}$$

We have to choose the arbitrary functions ϕ and ψ so as to satisfy given initial conditions. These conditions may be satisfied by making the surface (6) pass through a given curve, and touch a given developable all along that curve.

We may take, that is to say, $\xi, \eta, v, \frac{\partial v}{\partial \xi}, \frac{\partial v}{\partial \eta}$, to be, on this curve, given functions of a single variable λ , subject to the condition

$$\frac{dv}{d\lambda} = \frac{\partial v}{\partial \xi} \frac{d\xi}{d\lambda} + \frac{\partial v}{\partial \eta} \frac{d\eta}{d\lambda},$$

say

$$\xi = \xi_0(\lambda), \quad \eta = \eta_0(\lambda), \quad v = v_0(\lambda), \quad \frac{\partial v}{\partial \xi} = p_0(\lambda), \quad \frac{\partial v}{\partial \eta} = q_0(\lambda),$$

where

$$v_0' = p_0 \xi_0' + q_0 \eta_0'.$$

These equations will give us the values of $r, s, t, \alpha, \beta, \gamma, \delta,$

on the curve, where r, s, t denote $\frac{\partial^2 v}{\partial \xi^2}, \frac{\partial^2 v}{\partial \xi \partial \eta}, \frac{\partial^2 v}{\partial \eta^2}$, say r_0, s_0, t_0 ,
 $\alpha_0, \beta_0, \gamma_0, \delta_0$. For

$$\delta_0 = 2 \frac{p_0 + q_0}{\xi_0 + \eta_0},$$

$$\beta_0 = 2 \frac{r_0}{\xi_0 + \eta_0} + 2 \frac{p_0 + q_0}{(\xi_0 + \eta_0)^2}, \quad \gamma_0 = 2 \frac{t_0}{\xi_0 + \eta_0} + 2 \frac{p_0 + q_0}{(\xi_0 + \eta_0)^2},$$

$$p_0' = r_0 \xi_0' + s_0 \eta_0', \quad q_0' = s_0 \xi_0' + t_0 \eta_0',$$

$$r_0' = \alpha_0 \xi_0' + \beta_0 \eta_0', \quad t_0' = \gamma_0 \xi_0' + \delta_0 \eta_0'.$$

To determine the forms of ϕ and ψ , we have then, from equations (4) and (5),

$$\phi^V(\xi_0) = \frac{\alpha_0}{(\xi_0 + \eta_0)^2}, \quad \psi^V(\eta_0) = \frac{\delta_0}{(\xi_0 + \eta_0)^2}. \quad \dots \quad (7)$$

ϕ and ψ are thus to be determined by quadratures, and the results when substituted in equation (6) give the solution required.

4. The initial conditions are given in terms of the x, y , and t of equation (1), say,

$$y = f(x), \quad \frac{\partial y}{\partial t} = F(x), \quad \text{when } t=0^*,$$

These conditions necessitate

$$\frac{\partial y}{\partial x} = f'(x) \quad \text{when } t=0.$$

When the initial conditions are transformed so as to apply to equation (3), they become

$$\xi_0 = \frac{2a}{\gamma-1} \{f'(\lambda)\}^{-\frac{\gamma-1}{2}} + F(\lambda) = 5a \{f'(\lambda)\}^{-1/5} + F(\lambda),$$

$$\eta_0 = \frac{2a}{\gamma-1} \{f'(\lambda)\}^{-\frac{\gamma-1}{2}} - F(\lambda) = 5a \{f'(\lambda)\}^{-1/5} - F(\lambda),$$

$$v_0 = \lambda - \frac{f(\lambda)}{f'(\lambda)},$$

$$p_0 = q_0 = -\frac{1}{a} f(\lambda) \{f'(\lambda)\}^{-\frac{3-\gamma}{2}} = -\frac{1}{a} f(\lambda) \{f'(\lambda)\}^{-4/5},$$

where λ is the x of equation (1).

* Earnshaw's solution (which is the same as Poisson's integral) of equation (1) assumes $F(x) = \frac{2a}{\gamma-1} \{f'(x)\}^{-\frac{\gamma-1}{2}}$, i. e., $F(x) = 5a \{f'(x)\}^{-1/5}$ in this case. There does not seem to be any reason for this relation between the initial displacement and the velocity.

These equations give

$$s_0 \equiv 2(p_0 + q_0)/(\xi_0 + \eta_0) = -2f(\lambda)/5a^2\{f'(\lambda)\}^{3/5}.$$

The integration of equations (7) cannot, evidently, be completed except when f and F are specified functions; and even in the simplest case the labour of determining a solution is considerable.

5. It is, however, for our present purpose, unnecessary to go through this labour. Equation (2) reduces to

$$\frac{\partial^2 v}{\partial \xi \partial \eta} = 0 \quad \dots \dots \dots (8)$$

when $\gamma = 3$; and although this is widely different from its actual value, yet it will appear that, owing to the fact that $\frac{\partial y}{\partial x}$ is very nearly unity, the solution so obtained represents the facts with a fair degree of accuracy, and we shall be led to a second order approximation to the solution of equation (1) which, it so happens, holds for all values of γ .

In this case we may take the conditions to be satisfied in a rather more general form; *e. g.*, we may take

$$y = \lambda + Y(\lambda) = \int (PX' + QT) d\lambda, \quad t = T(\lambda), \quad x = X(\lambda), \quad \left. \vphantom{y} \right\} (9)$$

$$p = P(\lambda), \quad q = Q(\lambda),$$

where p and q stand for $\frac{\partial y}{\partial x}$ and $\frac{\partial y}{\partial t}$, respectively. From these equations we find, using the notation of the second paragraph, that

$$v = \frac{PX + QT - \lambda - Y}{P},$$

$$\xi = \frac{a}{P} + Q, \quad \eta = \frac{a}{P} - Q,$$

$$\frac{\partial v}{\partial \xi} = \frac{T}{2P} + \frac{QT - \lambda - Y}{2a}, \quad \frac{\partial v}{\partial \eta} = -\frac{T}{2P} + \frac{QT - \lambda - Y}{2a}.$$

The solution of equation (8) under these conditions is * given by eliminating θ and τ between the equations

$$v = \int \left\{ \frac{T(\theta)}{2P(\theta)} - \frac{Q(\theta)T(\theta) - \theta - Y(\theta)}{2a} \right\} \left\{ Q'(\theta) + \frac{aP'(\theta)}{P^2(\theta)} \right\} d\theta$$

$$+ \int \left\{ \frac{T(\tau)}{2P(\tau)} + \frac{Q(\tau)T(\tau) - \tau - Y(\tau)}{2a} \right\} \left\{ Q'(\tau) - \frac{aP'(\tau)}{P^2(\tau)} \right\} d\tau,$$

$$\xi = \frac{a}{P(\tau)} + Q(\tau), \quad \eta = \frac{a}{P(\theta)} - Q(\theta).$$

* See, for example, Goursat's 'Leçons sur l'Intégration des Equations aux dérivées Partielles du Second Ordre,' tom. i. p. 61 or 121.

Moreover,

$$\frac{\partial v}{\partial \xi} = \frac{T(\tau)}{2P(\tau)} + \frac{Q(\tau)T(\tau) - \tau - Y(\tau)}{2a},$$

$$\frac{\partial v}{\partial \eta} = -\frac{T(\theta)}{2P(\theta)} + \frac{Q(\theta)T(\theta) - \theta - Y(\theta)}{2a};$$

whence we find the solution of equation (1), when $\gamma=3$, *i. e.*,

$$\left(\frac{\partial y}{\partial x}\right)^4 \frac{\partial^2 y}{\partial t^2} = a^2 \frac{\partial^2 y}{\partial x^2}, \quad (10)$$

subject to the conditions (9), in the form

$$y = \left\{ \left(\frac{a}{P_2} + Q_2\right) \left(\frac{aT_1}{P_1} - Q_1T_1 + \theta + Y_1\right) - \left(\frac{a}{P_1} - Q_1\right) \left(\frac{aT_2}{P_2} + Q_2T_2 - \tau - Y_2\right) \right\} / \left\{ a \left(\frac{1}{P_1} + \frac{1}{P_2}\right) - Q_1 + Q_2 \right\},$$

$$x = \frac{1}{2a} \left\{ \int \left(\frac{aT_1}{P_1} - Q_1T_1 + \theta + Y_1\right) \left(Q_1' + \frac{aP_1'}{P_1^2}\right) d\theta + \int \left(\frac{aT_2}{P_2} + Q_2T_2 - \tau - Y_2\right) \left(Q_2' - \frac{aP_2'}{P_2^2}\right) d\tau + \frac{1}{2} \left[a \left(\frac{1}{P_1} + \frac{1}{P_2}\right) - Q_1 + Q_2 \right] \left(\frac{aT_1}{P_1} - \frac{aT_2}{P_2} - Q_1T_1 - Q_2T_2 + \theta + \tau + Y_1 + Y_2\right) \right\}$$

$$t = \left(\frac{aT_1}{P_1} + \frac{aT_2}{P_2} - Q_1T_1 + Q_2T_2 + \theta - \tau + Y_1 - Y_2\right) / \left\{ a \left(\frac{1}{P_1} + \frac{1}{P_2}\right) - Q_1 + Q_2 \right\},$$

where the subscript 1 means that the variable is θ , and the subscript 2 that the variable is τ . We also have

$$\frac{\partial y}{\partial x} \equiv p = 2a / \left\{ a \left(\frac{1}{P_1} + \frac{1}{P_2}\right) - Q_1 + Q_2 \right\},$$

$$\frac{\partial y}{\partial t} \equiv q = \frac{1}{2} \left\{ a \left(\frac{1}{P_1} - \frac{1}{P_2}\right) - Q_1 - Q_2 \right\}.$$

The solution evidently satisfies the conditions (9) when we put $\theta=\tau$ ($=\lambda$). We obtain the solution corresponding to given initial values of the displacement and velocity by putting $T=0$. Or we may obtain the solution corresponding to given values of y and $\frac{\partial y}{\partial x}$ when $x=0$, by putting $X=0$.

The conditions might be given in other forms ; for instance, one might wish to find the solution such that the displacement was a given function of x when $t=0$, and a given

function of t when $x=0$. Such solutions may be obtained fairly straightforwardly, but their importance is not such as to warrant our delaying to investigate them in this connexion.

Putting $Q=aZ'$, $T=0$, and therefore $P=1+Y'$, we find after a slight reduction that the solution of equation (10), subject to the conditions

$$y = x + Y(x), \quad q = aZ'(x), \quad \text{when } t=0,$$

is given by

$$y = \frac{\left\{ \left(\frac{1}{1+Y_1'} - Z_1' \right) (\tau + Y_2) + \left(\frac{1}{1+Y_2'} + Z_2' \right) (\theta + Y_1) \right\}}{\frac{1}{1+Y_1'} + \frac{1}{1+Y_2'} - Z_1' + Z_2'}$$

$$x = \frac{1}{2}(\theta + \tau) - \frac{1}{2}(Z_1 - Z_2) - \frac{1}{2} \int (Y_1' Z_1' d\theta - Y_2' Z_2' d\tau) \\ - \frac{1}{4}(\theta - \tau + Y_1 - Y_2) \left(\frac{1}{1+Y_1'} - \frac{1}{1+Y_2'} - Z_1' - Z_2' \right),$$

$$at = (\theta - \tau + Y_1 - Y_2) \int \left(\frac{1}{1+Y_1'} + \frac{1}{1+Y_2'} - Z_1' + Z_2' \right).$$

This solution cannot always represent the motion, for it becomes discontinuous after a certain time. We shall return to this point in paragraph 7.

6. To compare this with the ordinary approximate solution, namely,

$$y = x + \frac{1}{2}Y(x+at) + \frac{1}{2}Y(x-at) + \frac{1}{2}Z(x+at) - \frac{1}{2}Z(x-at),$$

we must expand y in terms of functions of $x+at$ and of $x-at$. To do this we make use of the fact that y is nearly equal to x —i. e., Y is small.

The reduction is long, but it is a good deal simplified by taking it in two stages. We consider first the case where $Z=0$, and retain only terms of the second order in the values of x , y , and t . We find

$$y = \frac{1}{2}(\theta + \tau) + \frac{1}{4}(\theta - \tau)(Y_1' - Y_2') \left[1 - \frac{1}{2}(Y_1' + Y_2') \right] \\ + \frac{1}{2}(Y_1 + Y_2) + \frac{1}{4}(Y_1 - Y_2)(Y_1' - Y_2'), \\ x + at = \theta + \frac{1}{2}(Y_1 - Y_2) + \frac{1}{2}(Y_1 - Y_2)Y_1' \\ + \frac{1}{2}(\theta - \tau) \left[Y_1' - \frac{1}{4}(Y_1' - Y_2')(3Y_1' + Y_2') \right], \\ x - at = \tau - \frac{1}{2}(Y_1 - Y_2) - \frac{1}{2}(Y_1 - Y_2)Y_2' \\ - \frac{1}{2}(\theta - \tau) \left[Y_2' + \frac{1}{4}(Y_1' - Y_2')(Y_1 + 3Y_2') \right].$$

And after reduction we find, as a second order approximation to the solution of equation (10), such that

$$y = x + Y(x), \quad q = 0, \quad \text{when } t=0,$$

$$y = x + \frac{1}{2}[Y(x+at) + Y(x-at)] \\ - \frac{1}{4}[Y(x+at) - Y(x-at)][Y'(x+at) - Y'(x-at)] \\ - \frac{1}{4}at[Y'^2(x+at) - Y'^2(x-at)].$$

The solution in this form is very easily verified. And in the process of verification we see that the second-order approximation corresponding to the conditions

$$y = x, \quad q = aZ'(x), \quad \text{when } t=0,$$

is

$$y = x + \frac{1}{2}[Z(x+at) - Z(x-at)] \\ + \frac{1}{4}[Z(x+at) - Z(x-at)][Z'(x+at) - Z'(x-at)] \\ - \frac{1}{4}at[Z'^2(x+at) - Z'^2(x-at)].$$

This solution might, of course, have been obtained in the same way as the other by assuming $Y=0$.

We note that the last two results are true for the general equation (1), provided that we substitute $\frac{\gamma+1}{16}$ for $\frac{1}{4}$ in the four places in which it occurs. This follows by verification.

We proceed to obtain the second order approximation to that solution of equation (1), which is such that

$$y = x + Y(x), \quad q = aZ'(x), \quad \text{when } t=0.$$

We write Y_1 for $Y(x+at)$, Y_2 for $Y(x-at)$, &c., and assume

$$y = x + \frac{1}{2}(Y_1 + Y_2) - \frac{\gamma+1}{16}(Y_1 - Y_2)(Y_1' - Y_2') - \frac{\gamma+1}{16}at(Y_1'^2 - Y_2'^2) \\ + \frac{1}{2}(Z_1 - Z_2) + \frac{\gamma+1}{16}(Z_1 - Z_2)(Z_1' - Z_2') - \frac{\gamma+1}{16}at(Z_1'^2 - Z_2'^2) \\ + \phi(x+at, x-at).$$

The first-order terms in $\frac{\partial y}{\partial x}$ and $\frac{\partial^2 y}{\partial t^2}$ are

$$\frac{\partial y}{\partial x} = \frac{1}{2}(Y_1' + Y_2') + \frac{1}{2}(Z_1' - Z_2') \\ \frac{\partial^2 y}{\partial t^2} = \frac{1}{2}a^2(Y_1'' + Y_2'') + \frac{1}{2}a^2(Z_1'' - Z_2'');$$

wherefore $\frac{\partial y}{\partial x}$ contributes to $\left(\frac{\partial y}{\partial x}\right)^{\gamma+1} \left(\frac{\partial^2 y}{\partial t^2}\right)$ a second order term

$$\frac{\gamma+1}{4} a^2 [(Y_1' + Y_2') + (Z_1' - Z_2')] [(Y_1'' + Y_2'') + (Z_1'' - Z_2'')],$$

of which only the parts $\frac{\gamma+1}{4} a^2 (Y_1' + Y_2')(Y_1'' + Y_2'')$, and $\frac{\gamma+1}{4} a^2 (Z_1' - Z_2')(Z_1'' - Z_2'')$, are accounted for without invoking the aid of the function ϕ . This function must therefore be such that

$$\frac{\partial^2 \phi}{\partial x^2} - \frac{1}{a^2} \frac{\partial^2 \phi}{\partial t^2} = \frac{\gamma+1}{4} [(Y_1' + Y_2')(Z_1'' - Z_2'') + (Y_1'' + Y_2'')(Z_1' - Z_2')], \quad (11)$$

with the conditions that ϕ , $\frac{\partial \phi}{\partial x}$, and $\frac{\partial \phi}{\partial t}$ are all zero when $t=0$.

Put $x+at=\theta$, $x-at=\tau$, so that Y_1 and Z_1 are functions of θ , Y_2 and Z_2 are functions of τ . Equation (11) then becomes

$$\frac{\partial^2 \phi}{\partial \theta \partial \tau} = \frac{\gamma+1}{16} [(Y_1' + Y_2')(Z_1'' - Z_2'') + (Y_1'' + Y_2'')(Z_1' - Z_2')],$$

with the conditions

$$\phi = \frac{\partial \phi}{\partial \theta} = \frac{\partial \phi}{\partial \tau} = 0, \quad \text{when } \theta = \tau.$$

The solution is

$$\phi = \frac{\gamma+1}{16} [\psi(\theta) - \psi(\tau) - \theta Y_2' Z_2' + \tau Y_1' Z_1' + Y_2 Z_1' - Y_1 Z_2' + Y_2' Z_1 - Y_1' Z_2],$$

where the function ψ is to be determined by the conditions

$$\frac{\partial \phi}{\partial \theta} = \frac{\partial \phi}{\partial \tau} = 0, \quad \text{when } \theta = \tau,$$

which reduce to one. We find

$$\psi(\theta) = 2 \int Y_1' Z_1' d\theta - \theta Y_1' Z_1' - Y_1 Z_1' + Y_1' Z_1;$$

and, finally, we obtain as the second order approximation to the solution of equation (1)

$$y = x + \frac{1}{2}(Y_1 + Y_2) + \frac{1}{2}(Z_1 - Z_2) - \frac{\gamma+1}{16} (Y_1' - Y_2') [Y_1 - Y_2 + at(Y_1' + Y_2')] + \frac{\gamma+1}{16} (Z_1' - Z_2') [Z_1 - Z_2 - at(Z_1' + Z_2')] + \frac{\gamma+1}{16} \left\{ 2 \int_{x-at}^{x+at} Y'(\theta) Z'(\theta) d\theta - 2at(Y_1' Z_1' + Y_2' Z_2') + (Y_1' + Y_2')(Z_1 - Z_2) - (Y_1 - Y_2)(Z_1' + Z_2') \right\} \dots \dots \dots (12)$$

7. We have now to determine when the motion becomes discontinuous. For this purpose we must return to the exact equations at the end of paragraph 5. These equations assume that $\gamma=3$, but it is evident that they give a very fair representation of what actually happens in a plane wave of sound,—assuming, of course, that the equation (1) takes account of all the facts. The form of the second order approximation, for example, in the case when $\gamma=3$ is exactly the same as when γ has its general value.

The motion becomes discontinuous when one of the three partial derivatives of the second order, $\frac{\partial^2 y}{\partial x^2}$, $\frac{\partial^2 y}{\partial x \partial t}$, $\frac{\partial^2 y}{\partial t^2}$ becomes infinite. It is evident, however, that they all become infinite together, so that we need consider only one of them.

We have

$$\frac{\partial^2 y}{\partial x^2} = \left(\frac{\partial p}{\partial \tau} \frac{\partial t}{\partial \theta} - \frac{\partial p}{\partial \theta} \frac{\partial t}{\partial \tau} \right) / \left(\frac{\partial x}{\partial \tau} \frac{\partial t}{\partial \theta} - \frac{\partial x}{\partial \theta} \frac{\partial t}{\partial \tau} \right),$$

where $p = \frac{\partial y}{\partial x}$; so that $\frac{\partial^2 y}{\partial x^2}$ becomes infinite when

$$\frac{\partial x}{\partial \tau} \frac{\partial t}{\partial \theta} - \frac{\partial x}{\partial \theta} \frac{\partial t}{\partial \tau} = 0,$$

which after reduction leads to

$$(1 + Y_2')^2 [(2 + Y_1' + Y_2') - (1 + Y_1')(1 + Y_2')(Z_1' - Z_2')] \\ = (1 + Y_1')(\theta - \tau + Y_1 - Y_2)[Y_2'' - Z_2''(1 + Y_2')^2], \quad (13)$$

or

$$(1 + Y_1')^2 [(2 + Y_1' + Y_2') - (1 + Y_1')(1 + Y_2')(Z_1' - Z_2')] \\ + (1 + Y_2')(\theta - \tau + Y_1 - Y_2)[Y_1'' + Z_1''(1 + Y_1')^2] = 0. \quad (14)$$

To find the time corresponding to these equations, we have

$$at = (\theta - \tau + Y_1 - Y_2) / \left\{ \frac{1}{1 + Y_1'} + \frac{1}{1 + Y_2'} - Z_1' + Z_2' \right\};$$

i. e.,

$$at = (1 + Y_2')^3 / [Y_2'' - Z_2''(1 + Y_2')^2], \quad . \quad . \quad (15)$$

or

$$at = -(1 + Y_1')^3 / [Y_1'' + Z_1''(1 + Y_1')^2]. \quad . \quad (16)$$

The time required is the smallest positive value of t

given by equation (15) or (16) when θ and τ are given by equation (13) or (14) and

$$x = \frac{1}{2}(\theta + \tau) - \frac{1}{2} \int (1 + Y_1') Z_1' d\theta + \frac{1}{2} \int (1 + Y_2') Z_2' d\tau - \frac{1}{4}(\theta - \tau + Y_1 - Y_2) \left\{ \frac{1}{1 + Y_1'} - \frac{1}{1 + Y_2'} - Z_1' - Z_2' \right\}.$$

If we retain only the terms of lowest order,

$$\left. \begin{aligned} at &= \frac{1}{2}(\theta - \tau) = 1/(Y_2'' - Z_2''), \\ x &= \frac{1}{2}(\theta + \tau) + \frac{1}{4}(Y_1' - Y_2' + Z_1' + Z_2')(\theta - \tau), \end{aligned} \right\} \dots (17)$$

or

$$\left. \begin{aligned} at &= \frac{1}{2}(\theta - \tau) = -1/(Y_1'' + Z_1''), \\ &\text{with the same value of } x \text{ as in equation (17).} \end{aligned} \right\} \dots (18)$$

8. A glance at equation (12) shows that the first order approximation

$$y = x + \frac{1}{2}[Y(x + at) + Y(x - at) + Z(x + at) - Z(x - at)]$$

ceases to hold when

$$at(Y_1'^2 - Y_2'^2 + Z_1'^2 - Z_2'^2 + 2Y_1'Z_1' + 2Y_2'Z_2') - 2 \int_{x-at}^{x+at} Y_1'Z_1' d\theta$$

ceases to be small compared with

$$Y_1 + Y_2 + Z_1 - Z_2,$$

where Y_1 and Z_1 are functions of $x + at$, Y_2 , Z_2 of $x - at$.

It is evident that t is in general of the order of magnitude of the least value of the reciprocal of Y , which is the same order as that given by equation (17) or (18).

In the particular case when $Y + Z = 0$, which, in the ordinary approximate solution, represents a single progressive wave,

$$y = x + Y(x - at),$$

the second order approximation is

$$y = x + Y(x - at) + \frac{\gamma + 1}{8} \left[2atY'^2 + \int_{x-at}^{x+at} Y'^2(\theta) d\theta \right],$$

which ceases to hold after a time t whose order of magnitude is given by

$$at = Y_2/Y_2'^2;$$

i. e., at is of the order of the reciprocal of the amplitude of the wave.

The motion becomes discontinuous after time t_1 , where

$$at_1 = 1/2Y_2'' = \frac{1}{2}(\theta - \tau),$$

θ and τ being connected by the relation

$$x = \frac{1}{2}(\theta + \tau) - \frac{1}{2}Y_2'(\theta - \tau) = \frac{1}{2}(\theta + \tau) - Y_2'/2Y_2''.$$

To take a simple numerical example, suppose

$$Y(x-at) = A \sin [\pi(x-at)/c].$$

Here

$$at = c^2/\pi^2 A, \quad at_1 = -c^2/(2\pi^2 A \sin \pi\tau/c),$$

where

$$\theta - \tau = -\frac{c^2}{\pi^2 A} \operatorname{cosec} \frac{\pi\tau}{c},$$

$$\theta + \tau = 2x - \frac{c}{\pi} \cot \frac{\pi\tau}{c};$$

so that

$$\tau = x + \frac{c^2}{2\pi^2 A} \operatorname{cosec} \frac{\pi\tau}{c} - \frac{c}{2\pi} \cot \frac{\pi\tau}{c}.$$

For a low note, just audible, we may take $c=200$ cm., *i. e.* a frequency of 80, and $A=10^{-6}$ cm.*; so that the equation for τ is

$$\tau = x + 2 \cdot 10^9 \operatorname{cosec} \frac{\pi\tau}{200} - \frac{100}{\pi} \cot \frac{\pi\tau}{200},$$

whence, for moderate distances, $\tau = -(2 \cdot 10^9 + 100)$ is the smallest negative root, and

$$at_1 = \frac{1}{2}(\theta - \tau) - x - \tau = 2 \cdot 10^9,$$

i. e.,

$$t_1 = 10^5 \text{ sec. nearly};$$

while t is of the same order of magnitude. The motion of the air due to a low, barely audible note is therefore such that viscosity and other influences will cause the motion to cease long before discontinuity sets in.

But a high, loud note, on the other hand, gives rise to a motion which instantly becomes discontinuous. Let us take, for instance, $c=2$ cm., *i. e.* a frequency of 8500, and $A=10^{-2}$ cm.† In this case the equation for τ is

$$\tau = x + 20 \operatorname{cosec} \frac{\pi\tau}{2} - \frac{1}{\pi} \cot \frac{\pi\tau}{2}.$$

* This is well within the range of audibility. See Rayleigh's 'Sound,' vol. ii. § 384, p. 439.

† This is the amplitude of the sound-wave, at a distance of 1 cm. from the source, in the experiment described on pp. 434 & 435 of Lord Rayleigh's 'Sound' (vol. ii.).

Whatever the value of x , the smallest negative root of this equation lies between $\tau = -20$ and $\tau = -22$; so that

$$at_1 = \frac{1}{2}(\theta - \tau) = x - \tau;$$

i. e.,
$$t_1 = \frac{x + 20}{34,000} = 10^{-3} \text{ sec. nearly,}$$

if x is not greater than about 20 cm., and t is of the same order.

It is evident that the value of t_1 cannot greatly vary with x . The reason for the appearance of x in this equation is that $\frac{1}{2}(\theta - \tau)$ was treated as large in forming the approximate values of x and t in equations (17).

The result $t_1 = 10^{-3}$ lends weight to the hypothesis that a very shrill note, *e. g.* a hiss, is not propagated in the same manner as an ordinary sound-wave.

When conductivity of heat and viscosity are taken into account, it has been shown by G. I. Taylor* that the motion in an ordinary sound-wave does not become discontinuous. The present paper is to be taken merely as an attempt to follow out the motion, before discontinuity ensues, on the assumption that equation (1) takes account of all the facts. With what happens in the neighbourhood of a discontinuity, when viscosity and conductivity are both zero, we are not here concerned, and the problem is one of little physical importance, though from a purely mathematical point of view it possesses a certain interest.

XXXV. *The Ions from Hot Salts.* By O. W. RICHARDSON, M.A., D.Sc., F.R.S., Professor of Physics, Princeton University †.

THIS paper describes the results of experiments which form a continuation of earlier work carried out in this laboratory, partly by the writer ‡ and partly by Dr. C. J. Davisson §. Some of the main points have already been briefly indicated ||. The chief object of the investigation has been the measurement of the specific charge or the electric molecular weight of the emitted ions; but in certain cases other points which seemed to be of interest or importance

* Proceedings of the Royal Society, A. vol. lxxxiv. 1910, pp. 371-7.

† Communicated by the Author.

‡ Phil. Mag. vol. xx. pp. 981, 999 (1910); vol. xxii. p. 669 (1911).

§ Phil. Mag. vol. xxiii. pp. 121, 139 (1912).

|| Phys. Rev. vol. xxxiv. p. 386 (1912).

have been examined and recorded. The salts which have been tested are those which are denoted by the following chemical formulæ:— ZnI_2 , CdI_2 , CaI_2 , $CaBr_2$, CaF_2 , SrI_2 , BaI_2 , Fe_2Cl_6 , and $MnCl_2$. The apparatus used in measuring e/m is the same as that previously described; but in many cases the ionization was neither sufficiently regular nor persistent to enable the ratio, of the charge passing through a narrow slit to the total charge emitted, to be measured in a sufficiently large number of positions. A different method was therefore adopted. The electrode behind the slit and one of the plates were connected to one pair of quadrants of the electrometer and the other plate to the other quadrants. All four quadrants of the electrometer were insulated and the position of the slit was determined for which the electrometer needle did not deflect when the quadrants were simultaneously connected to the respective plates. Under these circumstances both quadrants are receiving equal or sufficiently nearly equal charges (the capacity not being quite the same for the two sides of the system), and the position corresponds to the top of the humps in the curves previously shown. This position was determined for both directions of the magnetic field. The resulting displacement gives the value of e/m when substituted in the formula already deduced. This method has the great advantage that a determination of e/m only requires a minute or two, so that the variations of this quantity can be followed even when it is changing rather rapidly. On the other hand, it only gives a kind of average value if more than one kind of ion is present; so that it does not afford so complete an analysis as the former method, with which one could tell from the shape of the curves whether a mixture of ions or a single species was being encountered. I shall refer to this as the balance method and to the former as the slit method. Whenever the balance method gave results which seemed to be of a dubious character they were checked up by measurements in which the slit method was used if it was feasible to do so. I cannot recollect any case in which the two methods disagreed with one another; and in the case of substances like potassium sulphate, which give a very definite and persistent emission, the two methods give results which agree absolutely, so far as one can tell. In all cases the salts were heated on a flat strip of platinum which had previously been glowed out until it had lost its power of emitting ions at the temperature of the experiments. The investigation falls rather naturally into two divisions according to the sign of the ions dealt with.

1. POSITIVE IONS.

The papers already cited have shown that the salts of the alkali and alkaline earth metals emitted in appreciable quantity only univalent ions of the type Li_+ , Na_+ , K_+ , Rb_+ , Cs_+ , Ca_+ , Sr_+ and Ba_+ . In the case of the haloid salts of zinc there were indications of the presence of divalent as well as monovalent ions, the proportion of the former apparently increasing with the atomic weight of the haloid constituent. In order to obtain further information about this question new experiments have been made with the iodides of zinc and cadmium.

Zinc Iodide. ZnI_2 .

In the experiments with this substance the distance z between the strip and the plates was 1.256 cm., the magnetic field H was 2820 E.M. units, the electrostatic potential difference $V = 204 \times 10^8$ E.M. units, and the displacement $2x$ of the maximum, produced by reversing the magnetic field, is given, for a series of measurements, in the following table. Throughout this paper the unit in which x is expressed is 0.0635 cm.

Date	Nov. 6.	8.	9.	10.	11.	15.	16.
Number ...	1	2	3	4	5	6	7
$2x$	8.6	8.0	10.5	10.5	10.1	8.3	7.8
e/m	337	290	515	515	476	320	282
m/H	28.8	33.3	18.7	18.7	20.2	30.1	34.2

In No. 6 and No. 7 $V = 203$ and 202 volts respectively instead of 204.

The above data were all obtained by the slit method. Experiments 1-5 were made with one specimen of salt and experiments 6 and 7 with another. Nos. 3, 4 and 5, which show much higher values of e/m than the others, were made with the salt after it had been heated for a considerable time. The mean of the values of the electric atomic weight given by the freshly heated salt is 31.6. The value for Zn_{++} would be 32.7. The mean of the values from the old salt is 19.2 and suggests the presence of sodium as an impurity, although it is rather low. There was no indication in these experiments of the presence of potassium, which is the most common adventitious source of this kind of ionization. Unless the rather copious ionization from freshly heated zinc iodide all arises from contamination by impurities, which seems unlikely, the above results show quite clearly that practically all the ions are Zn_{++} and not Zn_+ .

Cadmium Iodide. CdI_2 .

The results of a series of experiments with this substance using the balance method are shown graphically in fig. 1. Values of the electric molecular weight m/H are plotted vertically against the time of heating in minutes as abscissæ.

Fig. 1.

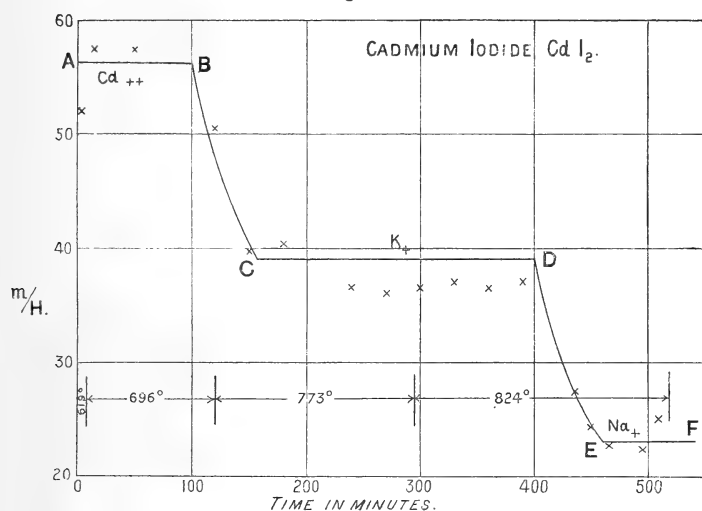

In order to get a sufficiently large thermionic current to determine the balance point satisfactorily, it was necessary to raise the temperature of the strip from time to time on account of the decay of the emission. The corresponding platinum resistance temperatures of the strip are set out near the bottom of the diagram. The experimental values of m/H are shown thus:— \times . The horizontal lines AB, CD, EF represent the chemical equivalent weights of the ions Cd^{++} , K^+ , and Na^+ . The experimental points follow the line AB at first, then break sharply to CD, and afterwards there is another sharp break to EF. The distance of the points from the curves ABCDEF is never greater than the possible error of measurements. Thus all the positive ions from cadmium iodide are accounted for by supposing that there is an emission of Cd^{++} , lasting in this case for about 2 hours; this is followed by K^+ and Na^+ in turn. The last two ions are presumably due to alkaline impurities present in the salt. There is no evidence of the occurrence of the monovalent ion Cd^+ . Thus the behaviour of the iodides of zinc and cadmium is very similar in this respect.

Some experiments with cadmium iodide by the slit method, although not altogether satisfactory in some respects, confirm the above results so far as they go. In order to have enough of the salt to give an emission lasting for a sufficiently long time, a considerable amount of it was melted on to the strip. The lowest temperature at which measurements could be made was 507° Pt. Under these conditions values of m/H as high as 440 were obtained, but the curves were very flat and of the form obtained when there is a considerable pressure of gas in the apparatus. This probably means that the measurements were spoiled by the presence of the iodine vapour which is given off by the heated salt. If there is any considerable quantity of gas or vapour present the method, as Davisson has shown, leads to spurious high values of m/H . When the strip had been heated for several hours two sets of observations led to the following respective values:—

1. $e/m = 146.5$, $m/H = 65.6$.
2. $e/m = 167$, $m/H = 57.9$.

The mean of these values is 61.7, which agrees with Cd_{++} within the limits of experimental error. The temperature in the final experiments was 930° Pt.

The above experiments show that when a strip of platinum on which cadmium iodide has been placed is heated, ions are given off which have an electric atomic weight corresponding to Cd_{++} . The high temperatures at which this effect is observed are against the view that the ions are produced directly by the action of heat on the iodide itself; since at these low pressures it would presumably have evaporated before the temperatures recorded were attained. I have not been able to obtain sufficient ionization to make measurements with, at the relatively low temperatures at which the ionization from CdI_2 has been observed* under other conditions. The ions here investigated probably arise either from the action on the hot platinum of cadmium iodide vapour which comes from cooler parts of the strip, or else from some less volatile substance with which the iodide is contaminated (*cf.* also the section below which deals with negative ions.) It is possible that somewhat similar considerations apply to the ions emitted by zinc iodide.

Strontium Iodide. SrI₂.

Although this substance gave a large emission of negative ions at a low temperature, the positive emission was not

* *Cf.* G. C. Schmidt, *Ann der Phys.* vol. xxxv. p. 404 (1911), and C. Sheard, *Phil. Mag.* vol. xxv. p. 370 (1913).

sufficiently permanent to make measurements with until relatively high temperatures were attained. An aqueous solution of the salt was placed on the strip. The results of the experiments are collected in the following table :—

$2x$	5.2	5.18	5.05	5.33	5.33
e/m	119	118	112	125	125
m/H	81.3	82.1	87.3	77.2	77.2
θ_{Pt}	1173°	1173°	1195°	1238°	1238°

The values m/H are in satisfactory agreement with the chemical equivalent of $Sr_+ = 87.6$, and they confirm the results obtained by Davisson (*loc. cit.*) with other strontium salts.

Ferric Chloride. $FeCl_3$.

This substance gave a positive emission at a low temperature, but it did not last very long. The following values of e/m and m/H were obtained at 518° Pt. :—

$2x$	7.0	7.10	7.05
e/m	238	245	242
m/H	40.2	39.3	39.8

There does not seem to be any satisfactory reason for supposing that the above numbers indicate anything except the presence of potassium as an impurity.

Manganous Chloride. $MnCl_2$.

Measurements with the positive ions emitted by this substance were made by the balance method. The structure of the ions was evidently changing rather rapidly as the experiment progressed. This is shown both by the following numbers and by the fact that consistent results could not be obtained by the slit method :—

Time (mins.) ...	0	10	25	35	45
e/m	284	214	186	136	139
m/H	33.9	44.9	51.6	70.6	69.1
θ_{Pt}	878°	878°	906°	906°	906°
Time (mins.) ...	55	65	70	80	90
e/m	129	121	211	175	244
m/H	75	79.4	45.6	55	39.2
θ_{Pt}	906°	906°	962°	962°	962°

The electric molecular weight increased from 33.9 to 79.4 and then fell back to 39.2. The light ions might be Mn_{++} ,

for which $m/H=27.5$, but on the whole Na_+ (23) and K_+ (39.1) are perhaps more probable. The heavy ions point to the existence of MnCl_+ (90.4) and possibly also Mn_+ (55). It is to be remembered that owing to the rapidity with which the values were changing, it is likely that most of the above numbers correspond to mixtures of ions having different values of e/m .

2. NEGATIVE IONS.

It is well known that most substances, if not all, emit negative electrons when they are heated to a sufficiently high temperature. Certain salts possess the property of emitting negative ions at relatively low temperatures. I find that in addition to the oxides, the following salts have this power:—The iodides of calcium, strontium, barium and cadmium, calcium fluoride, calcium bromide, manganous chloride and ferric chloride. This list is probably not exhaustive. In general, the negative ions emitted by these substances are not all electrons, but consist of a mixture of electrons and heavy ions. Calcium iodide appears to exhibit this property in a typical manner, and I have examined its behaviour in some detail.

Calcium Iodide. CaI_2 .

One of the objects of the experiments has been to measure the quantity of negative electrons and the quantity of heavy negative ions emitted under different conditions. The salt was placed on platinum strips, 1 mm. wide, mounted in the apparatus for measuring e/m already referred to. The length of the strips was about 1.3 cm. They were heated until the positive emission from the platinum had been got rid of, before the calcium iodide was placed on them. The apparatus was placed between the jaws of the electromagnet in the usual position for determining e/m . The current from the strip to the plates, when the strip was maintained at a potential of -80 volts with respect to the plates, was measured under two different conditions. Under the first condition a small current flowed through the windings of the electromagnet, so that there was a magnetic field large enough to stop the electrons from reaching the plate, but not large enough to stop any of the heavy ions. The proper magnetic field to use was found by separate experiments on the negative emission from a hot platinum strip without any salt on it. In these experiments I was not able to detect any emission of heavy ions, all the negative ions

given off by the hot platinum being electrons. This supports the recently published observations of Owen and Halsall*.

In the second case the current to the plates was measured when there was no current through the windings of the electromagnet. In this case the ions are only subject to the residual field of the electromagnet and the field due to the heating current in the strip. As the current was approximately saturated under these conditions, these fields are too small to stop even the electrons from getting across. It will be seen that the first measurement gives the quantity of electricity which is carried away from the strip in the form of heavy ions, and the second the total amount which is carried away both by the heavy ions and by the electrons.

The first measurements were made with the object of finding how the magnitude and relative proportion of these emissions varied with the temperature of the salt. The whole of the strip was covered with the salt. The temperatures given are platinum temperatures, and were deduced from the resistance of the strip. The results are intended only as a rough indication, and no great accuracy is claimed for them. In fact, the phenomena cannot be represented as a function of temperature in this way since, as will be shown below, the magnitude of the emission varies very rapidly with the time when the temperature of the salt is kept constant. The numbers in the following table (p. 460) were obtained by taking a series of measurements as rapidly as possible. Row 1 gives the platinum resistance temperature, row 2 the current in amperes carried by heavy ions, row 3 the current in amperes carried by heavy ions and electrons together, and row 4 the proportion of the whole current which is carried by electrons.

These measurements were not made with an entirely fresh specimen of the salt, but with one which had been heated for several hours at 400°. Otherwise the results would have been different in some important particulars. The numbers also are somewhat irregular owing to the combined effect of the temperature and time changes. However, they bear out the following conclusions which I have amply confirmed by other experiments:—

There is a surprisingly large emission of negative ions from calcium iodide at comparatively low temperatures. This property is also well shown by the iodides of the other metals of the alkaline earths. Thus I have observed a negative emission of about two milliamperes from a layer

* *Phil. Mag.* vol. xxv. p. 735 (1913).

(1)	292°	315°	325°	345°	365°	385°	405°	425°	445°
(2)	2.45×10^{-13}	9.8×10^{-13}	3.98×10^{-12}	1.32×10^{-11}	1.96×10^{-11}	4.33×10^{-11}	2.74×10^{-10}	3.04×10^{-9}	1.21×10^{-8}
(3)	3.92×10^{-13}	3.68×10^{-12}	1.27×10^{-11}	1.02×10^{-10}	2.58×10^{-10}	1.22×10^{-9}	3.77×10^{-9}	3.16×10^{-8}	1.06×10^{-7}
(4)	.375	.734	.685	.88	.92	.97	.93	.89	.89
<hr/>									
(1)	465°	479°	485°	505°	525°	545°	565°	605°	625°
(2)	6.6×10^{-9}	2.51×10^{-8}	7.26×10^{-8}	2.24×10^{-7}	3.56×10^{-7}	7.26×10^{-7}	9.24×10^{-7}	2.31×10^{-6}	2.73×10^{-6}
(3)	2.78×10^{-7}	4.95×10^{-7}	6.6×10^{-7}	1.45×10^{-6}	2.58×10^{-6}	5.01×10^{-6}	6.56×10^{-6}	2.74×10^{-5}	4.72×10^{-5}
(4)	.975	.95	.89	.85	.86	.855	.85	.915	.945
<hr/>									
(1)	645°	665°	685°	705°	725°	746°	766°	786°	
(2)	2.69×10^{-6}	4.62×10^{-6}	4.62×10^{-6}	6.34×10^{-6}	6.46×10^{-6}	7.65×10^{-6}	5.28×10^{-6}	4.62×10^{-6}	
(3)	8.97×10^{-5}	1.65×10^{-4}	2.93×10^{-4}	6.03×10^{-4}	$5.15 \times 10^{-3*}$	$1.53 \times 10^{-2*}$	8.18×10^{-6}	8.0×10^{-6}	
(4)	.97	.97	.93	.99	
<hr/>									
(1)	806°	826°		847°					
(2)	3.96×10^{-6}	3.96×10^{-6}		strip					
(3)	7.92×10^{-6}	7.92×10^{-6}		blew					
(4)		out.					

of barium iodide, a few square millimetres in area, before it was visible in an ordinarily lighted room. The emission increases very rapidly with the temperature when other conditions are unchanged. At low temperatures a relatively large proportion of this emission is carried by heavy ions. This proportion diminishes steadily as the temperature is raised, until at temperatures comparable with 700° practically all the current is carried by electrons.

In the experiment to which the above numbers refer a glow appeared (although the pressure of gas in the apparatus was only 0.001 mm. on the McLeod gauge) when the temperature was raised to 725° , and was accompanied by a large current when the magnetic field was off. The numbers taken under these conditions are indicated thus *. At 766° the potential was reduced from -80 to -40 volts, which caused the glow to disappear. The observations taken with 40 volts instead of 80 are shown thus †. Under these conditions the current was not saturated, and it is probable that the magnetic field kept back some of the heavy ions as well as the light ones. These numbers have not therefore the same significance as the others.

The above numbers indicate that the proportionate rate of increase of the emission with rising temperature is very much larger at low than at high temperatures. Part at least of this effect is spurious, as the emission at constant temperature was increasing with time at the low temperatures and diminishing with time at the high temperatures in these experiments (see below).

In view of the large proportion of the current which was carried by heavy ions at the lowest temperature in the experiments just recorded, new measurements were carried out with a fresh specimen of salt at the lowest temperature at which the emission could be measured conveniently. In comparing the emission with and without a magnetic field a difficulty was experienced owing to the change with time. To eliminate this, alternate readings with and without the field were taken as rapidly as possible after one another. Under these circumstances the changes of the effect from one measurement under given conditions to the next was not very great, and the mean of the two readings was taken to represent the value of the effect at the intermediate time at which the emission under the alternate condition was measured. Measurements carried out in this way at 325° led to the following successive values for the ratio of the emission with the stopping field to the emission without the field:—1.033, 0.974, 0.992, 1.034. The mean of these is 1.008.

Thus when a fresh specimen of calcium iodide is heated at a low temperature practically all the negative emission is carried by heavy ions and the proportion of negative electrons present is negligible.

Measurements of e/m for the heavy negative ions both by the slit and balance methods were made under these conditions at 325° , when the proportion of negative electrons present was negligible. The results are shown in the following table:—

TABLE I.

Method.	Balance.	Balance.	Balance.	Slit.
$2x$	4.10	4.01	4.00	3.85
e/m	85	82	81	75
m/H	113	119	119	128

The mean value of m/H is 120. This is not very different from the chemical equivalent weight of I_2 , viz. 127. Thus the heavy ions given off by calcium iodide at low temperatures are atoms of iodine combined with a single electron. The above values of e/m and m/H were confirmed by other measurements in which the applied electrostatic field was 82 and 40 volts respectively instead of 200, and there is every reason to believe they are correct. This is important because, as we shall see later, unexpected difficulties have arisen in determining e/m and m/H for the heavy negative ions which are present in other cases.

When the salt had got into a steady state at 400° , so that the emission varied very little with the time, measurements of the current with different applied negative potentials up to -200 were made, both with the magnetic field on and off. The resulting current-E.M.F. curves which are shown in fig. 2 are not very different from those given by the positive emission from most salts under conditions which are the same except for the different sign of the potential. The only important difference is the increase in the current between 160 and 200 volts when the electrons are present, which may perhaps be due to ionization by collisions.

The variation of the two kinds of emission with time when the salt was kept at a constant temperature was next examined. A speck of the salt about $.005$ cm.² in area was

placed at the centre of a special strip from which a little piece had been cut away on each side of the salt, which thus lay on an expansion between two slightly narrower necks. It was expected that this would keep the salt at a uniform temperature and, what is more important, tend to keep it

Fig. 2.

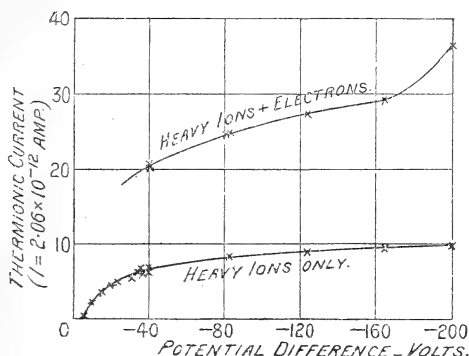

from flowing towards the ends of the strip. Most of these salts seem to have a tendency to flow on to the cooler parts of the hot metal. — In the present case the salt was bounded on both sides by the slightly narrower, and therefore hotter, portions and would thus tend to remain where it was placed. It is important that salt should not be present near the ends of the strip. For if it is, fresh salt is constantly being brought into play as the temperature of the strip is raised, owing to the hot region extending closer to the cold terminals. Moreover, the different portions of the salt are not all at the same temperature and, what makes matters worse, the salt flows about, so that its temperature distribution changes from time to time. So far as I have been able to judge, these difficulties are overcome by the device which has been described. With this arrangement the resistance of the strip was only used as an intermediate indication of the temperature of the salt. The temperature of the salt was finally obtained by placing specks of sodium chloride and of zinc at the place where the salt had been and observing the resistance of the strip at which the specks just melted. From these fiducial points and the resistance at the temperature of the laboratory a curve was constructed giving the actual centigrade temperature of the salt in terms of the corresponding resistance of the strip.

The results of some of these experiments are exhibited

graphically in figs. 3, 4, and 5. In each case a fresh sample of salt was used and approximately the same amount was taken. The currents are smaller than those already recorded for the same temperature. This is partly owing to the much smaller area of the salt used. The temperature was adjusted and measured as quickly as possible, a process which generally occupied about one minute, and then alternate readings were taken with the magnetic field on and off.

In each case the current rose to a maximum in about 15 minutes and then decayed more slowly than it had risen. Fig. 3 shows the results obtained at the lowest temperature (523°C). The currents in this case are quite small and

Fig. 3.

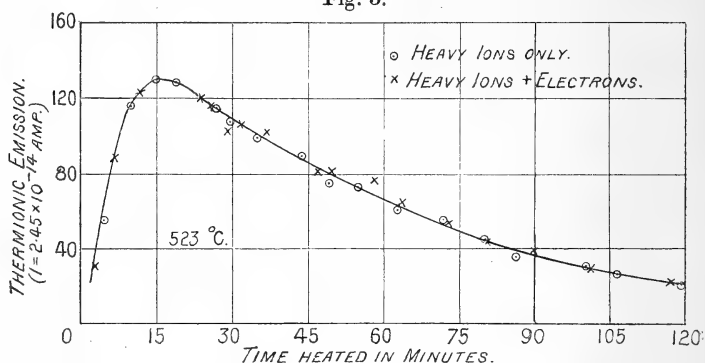
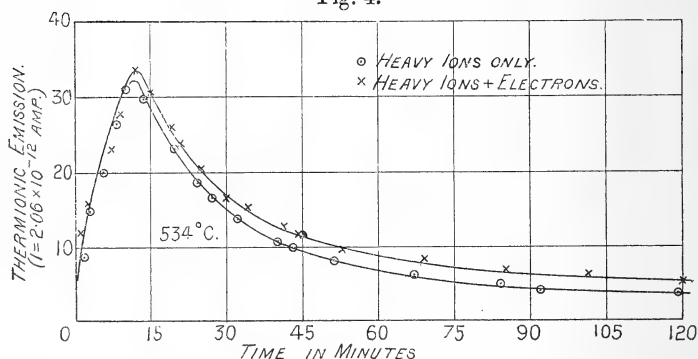

Fig. 4.



there is no detectable difference at any stage between the current when the stopping field is on and when it is off. This confirms our previous conclusion that at low temperatures, or at any rate when the fresh salt is giving a small emission, the entire current is carried by heavy ions.

Fig. 4 shows the results obtained at a slightly higher

temperature (534° C.). In this case also there is no distinct difference between the two currents at first; but after the maximum is passed, the current with the magnet on is distinctly smaller than that with it off. The actual current carried by electrons does not vary much after the first fifteen minutes. As the total current is then diminishing, the proportion of it which is carried by electrons continuously increases with lapse of time.

Fig. 5 shows the results obtained at a still higher temperature (654° C.). A much larger proportion of the current

Fig. 5.

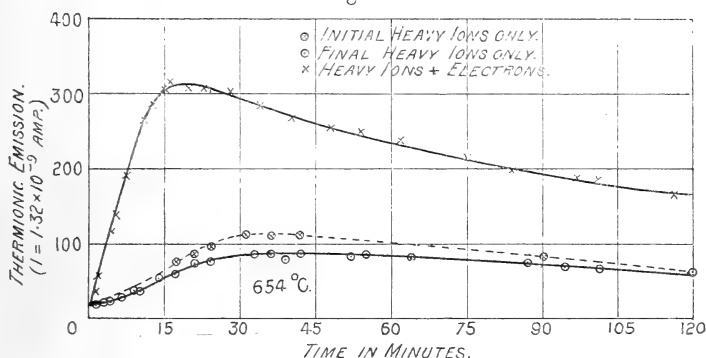

is now carried by electrons. The rate of decay of both parts of the current after passing the maximum is much smaller than that obtained at the lower temperatures. The current carried by heavy ions rises less rapidly at first than that carried by electrons, and the maximum occurs at a later time. At this temperature, and in other cases where a considerable proportion of the total current was carried by electrons, it was found that the current immediately after the magnetic field was switched on was greater than a few minutes later. In fig. 5 this initial current is shown thus: \otimes ; the steady value to which it settled down after a few minutes being denoted as before by \circ . The way in which the current carried by the heavy ions varied with the time after the magnet had been turned on is indicated by the following numbers, which were obtained in a particular instance:—

Time from switching magnet on..	0	1	2	3	4	5
(minutes).						
Current carried by heavy ions....	90	82	78.5	76	75	74.2
($1 = 1.32 \times 10^{-9}$ amp.).						

This phenomenon seems to indicate that some of the material which forms the heavy ions tends to accumulate, or

at least not to be carried away as rapidly when the magnetic field is turned off. The pressure as recorded on the McLeod gauge in the above experiments was a little under 0.001 mm.

Although the above results serve to outline some of the main features of the emission of negative ions from calcium iodide they do not cover the whole story. In carrying out the experiments I was often surprised to find the magnitude of the emission to be very different under what were apparently the same conditions on different occasions. This happened both on returning to examine a specimen which had previously been tested and also in examining different specimens which were about equal in amount and which seemed to have been treated in the same way. One cause of this difference seems to be that the salt loses its power of emission when it is left cold in a vacuum (at about 0.001 mm.) and can recover it when it is left exposed to air at a higher pressure. At any rate a number of experiments which were made agreed with this conclusion, although I am not clear as to what the nature of the change which occurs may be. The recovery occurred in dried air as well as in the ordinary air of the laboratory. The nature of these changes is exemplified by the following observations which were made on a single specimen of calcium iodide at 523° C.

When tested immediately after setting up, the air being pumped out as quickly as possible, curves similar to those in fig. 4 were obtained. The maximum current, which was reached in 15 minutes, was 1.24×10^{-9} amp.; it fell to 4.8×10^{-10} amp. in 100 minutes. After heating for 5 hours altogether, when the current was still comparable with the last value, it was left cold for 2 hours in the vacuum. On subsequently testing at 523° C. the current rose to a maximum of only 2.1×10^{-11} amp. and then fell off. After heating for one hour it was left all night in air at 20 cm. pressure. The maximum at 523° C. was then found to be 1.63×10^{-9} amp., or rather larger than that given by the fresh salt. After heating for 5 hours it was left cold in air at atmospheric pressure for 6 hours. The maximum at 523° C. was then found to be 2.4×10^{-9} amp. After heating continuously for about 24 hours the emission had only fallen to 1.13×10^{-9} amp., although no doubt this was due to air having leaked in through the low-pressure side of the Gaede pump to about half an atmosphere. The value of 1.13×10^{-9} amp., which was obtained after the air had been pumped out and the original temperature of 523° C. re-established, remained practically constant for over one hour. The salt was then left cold in the vacuum for $3\frac{1}{4}$ hours. It was tested at

523° C. and a maximum current of 8.6×10^{-11} amp. was recorded. This maximum was not reached until after 30 minutes, and the subsequent falling off was much less marked than before. After leaving in the vacuum cold for $2\frac{1}{2}$ hours, again practically the same values were obtained except that the maximum was reached more slowly and the curve was still flatter at the top. The salt was then left cold in dry air at atmospheric pressure for 20 hours. It was then tested at 523° C. and found to give a maximum current after 50 minutes of as much as 2.93×10^{-6} amp. The variation of both currents with time after this treatment is shown in fig. 6. After leaving cold in the vacuum for 14 hours

Fig. 6.

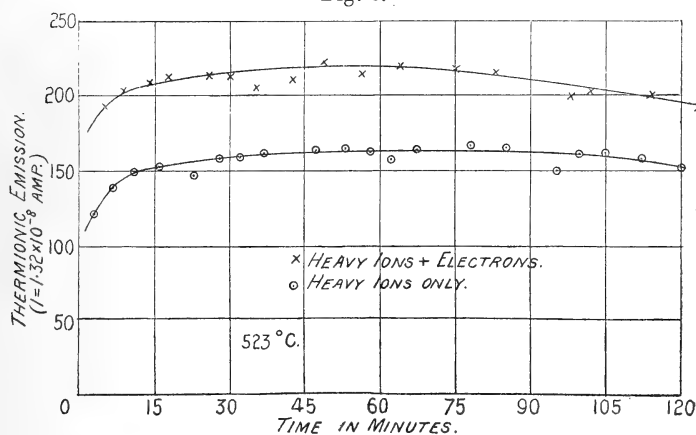

currents of about 2×10^{-10} amp. were obtained. The experiment was discontinued at this stage. The proportion of the total current which was carried by electrons tended to increase continually during the progress of this experiment. The proportionate increase was greater for the small currents obtained after leaving the cold salt in the vacuum than for the large currents obtained after exposing the cold salt to air. I do not propose to speculate about the cause of these peculiar effects at present.

The negative ionization from the various salts referred to below has not been examined so carefully and in so much detail as in the case of calcium iodide.

Strontium Iodide. SrI_2 .

This salt on first heating gave an emission which was large enough to make measurements of e/m with, without any

capacity in addition to that of the electrometer, at about 500° Pt. At first this emission was made up almost entirely of heavy ions. As the heating was continued at a constant temperature the percentage of the current which was carried by heavy ions diminished. On first heating the salt, when there were in all probability practically no electrons present in the emission, measurements of e/m and m/H were made by the balance method. Successive measurements which occupied 40 minutes gave the following values of m/H :— 113, 118, 115, 118, 118. These are sufficiently near the iodine value 127 to make it probable that the heavy ions are atoms of iodine with an attached electron.

After the salt had been heated at about 500° Pt. for about two hours, the following readings taken successively at rising temperatures give an idea of the magnitude and composition of the thermionic emission at different temperatures :—

Temperature } Pt.	467	495	522	551	578	606
Total current } (amps.).	1.45×10^{-11}	6.91×10^{-10}	3.01×10^{-9}	1.13×10^{-7}	5.47×10^{-7}	2.5×10^{-6}
Percentage } carried by I.	35	35	38	12.7	8.1	5.2

In these experiments the salt was placed all over the strip by means of a solution.

Attempts were made to measure e/m for the heavy ions present in the large current at 606° C. by the balance method, but it was found that no balance could be obtained with the field in one direction. In fact, this method (and also the slit method) of measuring e/m for the heavy negative ions fails when the full emission contains a large proportion of electrons. I have made a number of experiments to find out precisely what is going on under these conditions without arriving at any satisfactory conclusion. They seemed to show pretty definitely, however, that the failure was connected in some way with the presence of an excess of electrons and not to the magnitude of the currents or the presence of positive ions. This difficulty is unfortunate, as some of the salts investigated do not appear to emit heavy ions sufficiently free from electrons for e/m to be determined satisfactorily.

So far as the above experiments go they do not point to any important difference between the emission of negative ions from calcium and strontium iodides. The experiments show that the behaviour of the iodide of barium is also quite similar to that of calcium.

Barium Iodide. BaI_2 .

Measurements of m/H on first heating at 525° Pt. gave the following successive values of m/H , viz.:—103, 108, 105, 113, 116. These are rather low but may probably be taken to indicate I_- , (127). Experiments made after the salt had been heated some time failed on account of the presence of too many electrons.

Cadmium Iodide. CdI_2 .

A number of experiments were made to determine e/m for the negative ions emitted by this substance, but the success attained was rather limited. When the salt was heated initially a transient negative emission was observed, but it did not last long enough to enable e/m to be measured. This seemed rather surprising in view of the results obtained by Sheard* with this substance, but it is to be remembered that his experiments were carried out at much higher pressures. At the low pressure at which the present experiments were attempted (0.001 mm.) the salt would probably volatilize before the ionization occurred. This behaviour of the negative ionization supports the view of the nature of the positive ionization from this substance which was expressed on p. 456. In the present case experiments were tried with a millimetre or so of air present in the apparatus, and much larger negative emissions were obtained, but the pressure was then too high for e/m to be measured.

Under these circumstances I have had to be content with making qualitative experiments on the emission from the salt at about 1 mm. pressure. At 1.3 mm. I found that when the salt was first heated, about 16 per cent. of the emission was not stopped by the magnetic field, and that this proportion fell to 10 per cent. in about half an hour. At a higher temperature, after further heating, the proportion which was not stopped had fallen to 3.2 per cent. Although the conditions are rather complicated at this pressure it seems a fair inference that both heavy ions and electrons are given off by the salt, and that the proportion of the current which is carried by electrons is greater at higher temperatures and increases with continued heating as with the other iodides which have been examined.

Ferric Chloride. FeCl_3 .

This substance gave a transient negative emission which was too small to make measurements with.

* Phil. Mag. vol. xxv. p. 370 (1913).

Manganous Chloride. MnCl_2 .

This substance gave a negative emission at about 570°Pt. , which lasted long enough to enable the following successive values of e/m and m/H for the heavy negative ions to be determined by the balance method:—

$2x$	5.4	5.8	4.9	4.8	4.8
e/m	141	163	116	112	112
m/H	68	59	82	88	88

I do not feel confident that anything more ought to read into the meaning of the above numbers than that they imply the presence of heavy negative ions of molecular or atomic magnitude, as there was some indication of the presence of too many electrons. This salt deserves further investigation.

Calcium Fluoride. CaF_2 .

This substance gave a very definite emission which contained a large percentage of electrons even on first heating. The following numbers, obtained after the salt had been heated for about 2 hours at 600°C. , give an idea of the nature of this emission:—

Temperature } ($^\circ\text{Pt.}$).	468	499	531	569	594	625
Total current } (amp.).	8.9×10^{-13}	2.8×10^{-11}	1.34×10^{-10}	3.9×10^{-10}	1.33×10^{-9}	3.65×10^{-9}
Percentage carried } by heavy ions.	8.3	5.7	14	20.4	13.3	13.8
Temperature } ($^\circ\text{Pt.}$).	656	687	719	750	781	
Total current } (amp.).	3.7×10^{-8}	1.48×10^{-7}	4.6×10^{-7}	2.1×10^{-6}	5.7×10^{-6}	
Percentage carried } by heavy ions.	11.7	6.3	6.3	4	4	

About 800° the current only increased slowly with the temperature. A subsequent test showed that when the temperature was raised slowly from 781° to 1030°Pt. , the emission only increased by a factor of 4. In these experiments it was noticed that when the magnetic field was turned on, the current was small initially and rose in a few minutes to a steady value. This behaviour is precisely opposite to that observed with calcium iodide when the same change had been made.

Immediately after the salt was first heated measurements of e/m were made by the balance method. Four consistent measurements gave $m/H=97$. This value is difficult to interpret, and I am inclined to think that the electrons present were vitiating the measurements.

Calcium Bromide. CaBr_2 .

The emission from this substance did not seem either so copious or so persistent as that from the iodides of the alkaline earth metals and from calcium fluoride, but it lasted long enough to make a number of experiments with it. An experiment with fresh salt at 465° Pt. gave an emission of about 3×10^{-11} amp., which varied very little for about 15 minutes and then fell away quite rapidly. Practically none of this emission was stopped by the magnetic field, so that it apparently consisted entirely of heavy ions.

Measurements of e/m were made on another freshly heated specimen using the balance method. Different negative potentials were applied in order to check the consistency of the results. Previous work on the other salts had shown that when the method for determining e/m for the heavy negative ions was not working satisfactorily (owing to the cause which has been tentatively attributed to an effect arising from the negative electrons) the values obtained when different potentials were used did not agree with one another. The numbers obtained in the present case are shown in the following table:—

Negative Potential (volts)...	214	128	84	42
$2x$ ($1=0.625$ cm.)	4.65	5.97	7.35	10.85
e/m	108	107	106	116
m/H	89	90	91	82
Temperature ($^\circ$ Pt.)	526	526	526	526

These values of m/H are sufficiently consistent and the mean 88 is near enough to 80, the chemical equivalent weight of Br, to indicate definitely that the ions from this substance are most probably atoms of bromine which are combined with an electron.

It is perhaps worthy of remark that the deviations of the observed values of m/H from the calculated values for the ions to which they have been attributed are in every case, for the heavy negative ions examined, in such a direction as would occur if the ions in question were mixed with another kind for

which m/H = about 100. This may point to an undiscovered common impurity which gives rise to heavy negative ions, but the reliability and accuracy of the measurements of m/H for these heavy ions are insufficient to establish such a conclusion at present.

In conclusion I wish to thank my assistant, Mr. E. S. Taylerson, for his help in carrying out these experiments.

Palmer Physical Laboratory,
Princeton, N. J.

XXXVI. *The Absorption of Heat produced by the Emission of Ions from Hot Bodies*: II. By H. L. COOKE, Assistant Professor of Physics, and O. W. RICHARDSON, F.R.S., Professor of Physics, Princeton University*.

IN a recent paper † we have shown that when a current of negative electrons is allowed to flow from a heated filament of osmium, there is an absorption of heat which is equal in amount to the energy required to drive the escaping electrons through a potential difference of 4.7 volts. The present paper deals with similar experiments which we have made with lime-coated platinum wires and with tungsten wires. Neither the apparatus used nor the method of experimenting has been changed in any important particular, so that it will be sufficient to refer to the former paper for their description and simply to record the results which have been obtained. We shall also use the same notation as before.

The behaviour of lime-coated platinum wires is of particular interest since it was with this combination of substances that the first attempts were made, by Wehnelt and his pupils ‡, to detect the effect under investigation. Our experiments agree with theirs in showing that the phenomena exhibited by lime-coated platinum wires do not exhibit any evident relationship with the theory of these effects. Their behaviour is quite different from that of the osmium and tungsten wires. In the case of the latter substances the

* Communicated by the Authors.

† Phil. Mag. vol. xxv. (1913) p. 624.

‡ Cf. Wehnelt & Jentzsch, *Ann. der Phys.* vol. xxviii. p. 537 (1909), and Schneider, *Ann. der Phys.* vol. xxxvii. p. 569 (1912).

thermal changes which take place when the thermionic current is turned on or off all occur within a few seconds. In fact in our experiments the time within which these changes were completed was comparable with the period of the galvanometer used in the Wheatstone's bridge. With the lime-coated platinum wires, under otherwise identical circumstances, it was questionable whether the changes were complete in a time comparable with ten minutes. The precise nature of the changes also depended rather definitely on the mode of preparation of the lime-coated surface. Different wires presented different peculiarities of behaviour, but there were certain features common to the behaviour of all the wires examined, which were briefly as follows:— Upon allowing conditions to become steady, with the Wheatstone's bridge balanced it was found that turning on the thermionic current caused the galvanometer to indicate a decrease in the resistance of the wire under examination. The nature of this change was not, however, similar to that observed in the case of osmium and tungsten wires, but rather indicated a fairly steady rate of decrease in the resistance with the time. In the case of some wires examined this rate of decrease of resistance due to the flow of the thermionic current showed no clear signs of abatement at the end of an interval of fifteen minutes. This peculiarity of behaviour could not be ascribed to a natural sluggishness of the wires to adjust themselves to alternations in the thermal or energy conditions, for when the rate of supply of electrical energy was suddenly altered by increasing the heating current in the manner described in our previous paper, the galvanometer indicated that the corresponding resistance changes were complete in considerably less than thirty seconds, as in the case of the osmium and tungsten wires. With regard to the magnitude of the steady rate of decrease of resistance observed when the thermionic current was flowing, it was found that the deflexion of the galvanometer produced by ten minutes flow of thermionic current yielded a value of the apparent loss of energy per unit current of considerably over one hundred equivalent volts, the calculations being made on the assumption that the galvanometer deflexion was due to a true cooling effect brought about by the thermionic emission, as demanded by the theory of the experiments. It seems evident that this change in resistance is not to be ascribed to the cooling effect sought for in this investigation. This conclusion is supported by the fact that upon stopping the thermionic

current the galvanometer did not always indicate an increase in resistance corresponding to a recovery from the cumulative decrease brought about by the previous thermionic emission, although in most cases such a recovery was undoubtedly indicated. Attempts were made to detect the cooling effect sought by trying to detect a sudden initial decrease of resistance of the wire caused by turning on the thermionic current in addition to the cumulative effect just described, but without success. Our conclusion with regard to lime-coated platinum wires is that if the effect sought is present it is masked by the larger cumulative effect. No attempts were made to examine this cumulative effect in great detail, but it is perhaps worth mentioning that the data obtained in the course of this investigation would be satisfactorily explained on the assumption that this effect is due to an increase in the radiating power of the surface of the lime brought about by electrolytic effects in the lime occasioned by the passage through it of the thermionic current.

Experiments with Tungsten Wires.

The behaviour of this material resembles that of the osmium filaments already investigated and is quite different from the lime-coated wires. The change of resistance due to turning the thermionic current on or off is complete in a few seconds, and the cooling effect when the current is turned on is equal to the heating effect when the current is turned off.

The ductile tungsten wire used was 3.3 cm. long and 0.00375 cm. in diameter. It was kindly presented to us by Dr. W. R. Whitney, of the General Electric Co. After being welded electrically in hydrogen to stout german-silver leads, it was sealed into a glass tube so as to pass axially down a cylindrical electrode of copper foil 3.5 cm. in diameter. The ends of the latter were boxed in by sheets of the foil with a small hole in the centre, so that the electrode practically enclosed the hot wire. The tube was exhausted and heated for several hours in a vacuum furnace at a temperature of 550°–570° C. With the tube at 250°–300° C. the wire was glowed out at above 2500° K. in a liquid air and charcoal vacuum until the evolution of gas was not more than 10^{-3} c.c. \times mm. of mercury in 5 minutes. It was then sealed off for use. The measurements were carried out exactly as described in the previous paper. Some of the experimental data are given, using our former notation, in the following table:—

$\theta^\circ\text{K.}$	D_T	D_E	T amp. $\times 10^{-6}$	i_1 amp.	R ohms.	V volts.	Fil. sh.		Stan. sh.	
							F→S (1)	S→F (2)	F→S (3)	S→F (4)
1960	13.54	1.64	572	.343	16.6	23.8				7.92
"	9.45	1.70	603	.343	16.26	23.8		4.95		
"	8.55	1.65	632	.342	16.3	23.8	4.37			
1980	2.66	1.67	752	.342	16.51	23.8			1.14	
.....										
1865	.84	1.46	176.9	.315	15.71	23.7			1.31	
"	2.54	1.46	161.5	.320	15.43	23.7	4.47			
"	2.86	1.47	182.7	.320	15.43	23.7		4.42		
"	5.43	1.50	207	.320	15.70	23.7				7.37
.....										
1935	10.51	1.572	437.1	.338	16.22	23.7				7.87
"	4.96	1.564	420.8	.338	15.94	23.7		3.80		
"	6.09	1.825	433.3	.338	15.95	23.7	3.88			
"	2.17	1.594	499.5	.338	16.22	23.7			1.45	

In the units in which D_T and D_E are expressed in the above table the insensitiveness of the galvanometer was 1.24×10^{-7} and equation (13) of the former paper becomes

$$\Delta R_e = 1.24 \times 10^{-7} [G + 100R(1.01 + .001G)] \times D_E. \quad (13')$$

After substituting the above numbers in our former equation (12) the resulting values of the cooling effect in equivalent volts at the temperatures named are:—

$\theta_0\text{K}$	1865	1935	1965	1922	Average.
$\phi(1+2)$...	4.34	3.73	4.57	4.21 ₃	} Equivalent Volts.
$\phi(3+4)$...	4.49	4.35	3.97	4.27	
Means	4.41 ₅	4.04	4.27	4.24	

Higher values than those just given were obtained at higher temperatures and large thermionic currents, but the measurements under these conditions are subject to large errors which we have not yet succeeded in disentangling.

The mean of the above values of ϕ , viz. 4.24 volts, compares with 4.7 volts for osmium found in the former experiments. The thermionic current i from the above tube at different temperatures θ has been measured by O. W. Richardson and K. K. Smith. It was found to follow the formula $i = A\theta^2 e^{-b/\theta}$, where A and b are constants, from 1500°K. to 2300°K. By putting $b = \phi/R$ these measurements gave $\phi = 3.585$ volts, a lower value than that given by the cooling

effect. However, later measurements which they made after the tube had been differently treated led to a higher value of b , and the investigation referred to is not yet completed, so that the difference in the value of ϕ given by the two methods may not be significant.

In concluding we wish to correct an erroneous statement on p. 643 of the former paper. Maturer consideration has led us to conclude that the small systematic error referred to in the last paragraph but two makes the measured value of ϕ too large at high temperatures and not too small as is there stated. In consequence we do not now regard the suggested increase of ϕ with θ as definitely established by the experiments. They are, in fact, insufficiently accurate for the purpose.

We are glad to be able to take this opportunity of thanking Messrs. W. P. Schenck and W. R. Wensley, who took most of the observations under our direction.

Palmer Physical Laboratory,
Princeton, N.J.

XXXVII. *On the Constitution of Atoms and Molecules.*
By N. BOHR, *Dr. phil. Copenhagen* *.

PART II.—SYSTEMS CONTAINING ONLY A SINGLE NUCLEUS †.

§ 1. *General Assumptions.*

FOLLOWING the theory of Rutherford, we shall assume that the atoms of the elements consist of a positively charged nucleus surrounded by a cluster of electrons. The nucleus is the seat of the essential part of the mass of the atom, and has linear dimensions exceedingly small compared with the distances apart of the electrons in the surrounding cluster.

As in the previous paper, we shall assume that the cluster of electrons is formed by the successive binding by the nucleus of electrons initially nearly at rest, energy at the same time being radiated away. This will go on until, when the total negative charge on the bound electrons is numerically equal to the positive charge on the nucleus, the system will be neutral and no longer able to exert sensible forces on electrons at distances from the nucleus great in comparison with the dimensions of the orbits of the bound electrons. We may regard the formation of helium from α rays as an

* Communicated by Prof. E. Rutherford, F.R.S.

† Part I. was published in *Phil. Mag.* xxvi. p. 1 (1913).

observed example of a process of this kind, an α particle on this view being identical with the nucleus of a helium atom.

On account of the small dimensions of the nucleus, its internal structure will not be of sensible influence on the constitution of the cluster of electrons, and consequently will have no effect on the ordinary physical and chemical properties of the atom. The latter properties on this theory will depend entirely on the total charge and mass of the nucleus; the internal structure of the nucleus will be of influence only on the phenomena of radioactivity.

From the result of experiments on large-angle scattering of α -rays, Rutherford* found an electric charge on the nucleus corresponding per atom to a number of electrons approximately equal to half the atomic weight. This result seems to be in agreement with the number of electrons per atom calculated from experiments on scattering of Röntgen radiation †. The total experimental evidence supports the hypothesis ‡ that the actual number of electrons in a neutral atom with a few exceptions is equal to the number which indicates the position of the corresponding element in the series of elements arranged in order of increasing atomic weight. For example on this view, the atom of oxygen which is the eighth element of the series has eight electrons and a nucleus carrying eight unit charges.

We shall assume that the electrons are arranged at equal angular intervals in coaxial rings rotating round the nucleus. In order to determine the frequency and dimensions of the rings we shall use the main hypothesis of the first paper, viz.: that in the permanent state of an atom the angular momentum of every electron round the centre of its orbit is equal to the universal value $\frac{h}{2\pi}$, where h is Planck's constant.

We shall take as a condition of stability, that the total energy of the system in the configuration in question is less than in any neighbouring configuration satisfying the same condition of the angular momentum of the electrons.

If the charge on the nucleus and the number of electrons in the different rings is known, the condition in regard to the angular momentum of the electrons will, as shown in § 2, completely determine the configuration of the system, i. e., the frequency of revolution and the linear dimensions of the rings. Corresponding to different distributions of the

* Comp. also Geiger and Marsden, *Phil. Mag.* xxv. p. 604 (1913).

† Comp. C. G. Barkla, *Phil. Mag.* xxi. p. 648 (1911).

‡ Comp. A. v. d. Broek, *Phys. Zeitschr.* xiv. p. 32 (1913).

electrons in the rings, however, there will, in general, be more than one configuration which will satisfy the condition of the angular momentum together with the condition of stability.

In § 3 and § 4 it will be shown that, on the general view of the formation of the atoms, we are led to indications of the arrangement of the electrons in the rings which are consistent with those suggested by the chemical properties of the corresponding element.

In § 5 it will be shown that it is possible from the theory to calculate the minimum velocity of cathode rays necessary to produce the characteristic Röntgen radiation from the element, and that this is in approximate agreement with the experimental values.

In § 6 the phenomena of radioactivity will be briefly considered in relation to the theory.

§ 2. Configuration and Stability of the Systems.

Let us consider an electron of charge e and mass m which moves in a circular orbit of radius a with a velocity v small compared with the velocity of light. Let us denote the radial force acting on the electrons by $\frac{e^2}{a^2} F$; F will in general be dependent on a . The condition of dynamical equilibrium gives

$$\frac{mv^2}{a} = \frac{e^2}{a^2} F.$$

Introducing the condition of universal constancy of the angular momentum of the electron, we have

$$mva = \frac{h}{2\pi}.$$

From these two conditions we now get

$$a = \frac{h^2}{4\pi^2 e^2 m} F^{-1} \quad \text{and} \quad v = \frac{2\pi e^2}{h} F; \quad \dots \quad (1)$$

and for the frequency of revolution ω consequently

$$\omega = \frac{4\pi^2 e^4 m}{h^3} F^2. \quad \dots \quad (2)$$

If F is known, the dimensions and frequency of the corresponding orbit are simply determined by (1) and (2). For a

ring of n electrons rotating round a nucleus of charge Ne we have (comp. Part I., p. 20)

$$F = N - s_n, \quad \text{where} \quad s_n = \frac{1}{4} \sum_{s=1}^{s=n-1} \operatorname{cosec} \frac{s\pi}{n}.$$

The values for s_n from $n=1$ to $n=16$ are given in the table on p. 482.

For systems consisting of nuclei and electrons in which the first are at rest and the latter move in circular orbits with a velocity small compared with the velocity of light, we have shown (see Part I., p. 24) that the total kinetic energy of the electrons is equal to the total amount of energy emitted during the formation of the system from an original configuration in which all the particles are at rest and at infinite distances from each other. Denoting this amount of energy by W , we consequently get

$$W = \sum \frac{m}{2} v^2 = \frac{2\pi^2 e^4 m}{h^2} \Sigma F^2. \quad \dots \quad (3)$$

Putting in (1), (2), and (3) $e = 4.7 \cdot 10^{-10}$, $\frac{e}{m} = 5.31 \cdot 10^{17}$, and $h = 6.5 \cdot 10^{-27}$ we get

$$\left. \begin{aligned} a &= 0.55 \cdot 10^{-8} F^{-1}, \quad v = 2.1 \cdot 10^8 F, \quad \omega = 6.2 \cdot 10^{15} F^2 \\ \text{and} \end{aligned} \right\} \quad (4)$$

$$W = 2.0 \cdot 10^{-11} \Sigma F^2.$$

In neglecting the magnetic forces due to the motion of the electrons we have in Part I. assumed that the velocities of the particles are small compared with the velocity of light. The above calculations show that for this to hold, F must be small compared with 150. As will be seen, the latter condition will be satisfied for all the electrons in the atoms of elements of low atomic weight and for a greater part of the electrons contained in the atoms of the other elements.

If the velocity of the electrons is not small compared with the velocity of light, the constancy of the angular momentum no longer involves a constant ratio between the energy and the frequency of revolution. Without introducing new assumptions, we cannot therefore in this case determine the configuration of the systems on the basis of the considerations in Part I. Considerations given later suggest, however, that the constancy of the angular momentum is the principal condition. Applying this condition for velocities

not small compared with the velocity of light, we get the same expression for v as that given by (1), while the quantity m in the expressions for α and ω is replaced by $\frac{m}{\sqrt{(1-v^2/c^2)}}$, and in the expression for W by

$$m \cdot 2 \frac{c^2}{v^2} \left(1 - \sqrt{1 - \frac{v^2}{c^2}} \right).$$

As stated in Part I., a calculation based on the ordinary mechanics gives the result, that a ring of electrons rotating round a positive nucleus in general is unstable for displacements of the electrons in the plane of the ring. In order to escape from this difficulty, we have assumed that the ordinary principles of mechanics cannot be used in the discussion of the problem in question, any more than in the discussion of the connected problem of the mechanism of binding of electrons. We have also assumed that the stability for such displacements is secured through the introduction of the hypothesis of the universal constancy of the angular momentum of the electrons.

As is easily shown, the latter assumption is included in the condition of stability in § 1. Consider a ring of electrons rotating round a nucleus, and assume that the system is in dynamical equilibrium and that the radius of the ring is a_0 , the velocity of the electrons v_0 , the total kinetic energy T_0 , and the potential energy P_0 . As shown in Part I. (p. 21) we have $P_0 = -2T_0$. Next consider a configuration of the system in which the electrons, under influence of extraneous forces, rotate with the same angular momentum round the nucleus in a ring of radius $a = \alpha a_0$. In this case we have $P = \frac{1}{\alpha} P_0$, and on account of the uniformity of the angular momentum $v = \frac{1}{\alpha} v_0$ and $T = \frac{1}{\alpha^2} T_0$. Using the relation $P_0 = -2T_0$, we get

$$P + T = \frac{1}{\alpha} P_0 + \frac{1}{\alpha^2} T_0 = P_0 + T_0 + T_0 \left(1 - \frac{1}{\alpha} \right)^2.$$

We see that the total energy of the new configuration is greater than in the original. According to the condition of stability in § 1 the system is consequently stable for the displacement considered. In this connexion, it may be remarked that in Part I. we have assumed that the frequency of radiation emitted or absorbed by the systems cannot be determined from the frequencies of vibration of the electrons in the plane of the orbits, calculated by help of the ordinary

mechanics. We have, on the contrary, assumed that the frequency of the radiation is determined by the condition $h\nu = E$, where ν is the frequency, h Planck's constant, and E the difference in energy corresponding to two different "stationary" states of the system.

In considering the stability of a ring of electrons rotating round a nucleus for displacements of the electrons perpendicular to the plane of the ring, imagine a configuration of the system in which the electrons are displaced by $\delta z_1, \delta z_2, \dots, \delta z_n$ respectively, and suppose that the electrons, under influence of extraneous forces, rotate in circular orbits parallel to the original plane with the same radii and the same angular momentum round the axis of the system as before. The kinetic energy is unaltered by the displacement, and neglecting powers of the quantities $\delta z_1, \dots, \delta z_n$ higher than the second, the increase of the potential energy of the system is given by

$$\frac{1}{2} \frac{e^2}{a^3} N \Sigma (\delta z)^2 - \frac{1}{32} \frac{e^2}{a^3} \Sigma \Sigma \left| \operatorname{cosec}^3 \frac{\pi(r-s)}{n} \right| (\delta z_r - \delta z_s)^2,$$

where a is the radius of the ring, Ne the charge on the nucleus, and n the number of electrons. According to the condition of stability in § 1 the system is stable for the displacements considered, if the above expression is positive for arbitrary values of $\delta z_1, \dots, \delta z_n$. By a simple calculation it can be shown that the latter condition is equivalent to the condition

$$N > p_{n,0} - p_{n,m}, \dots \dots \dots (5)$$

where m denotes the whole number (smaller than n) for which

$$p_{n,k} = \frac{1}{8} \sum_{s=1}^{s=n-1} \cos 2ks \frac{s\pi}{n} \operatorname{cosec}^3 \frac{s\pi}{n}$$

has its smallest value. This condition is identical with the condition of stability for displacements of the electrons perpendicular to the plane of the ring, deduced by help of ordinary mechanical considerations*.

A suggestive illustration is obtained by imagining that the displacements considered are produced by the effect of extraneous forces acting on the electrons in a direction parallel to the axis of the ring. If the displacements are produced infinitely slowly the motion of the electrons will at any moment be parallel to the original plane of the ring, and the angular momentum of each of the electrons round

* Comp. J. W. Nicholson, Month. Not. Roy. Astr. Soc. 72. p. 52(1912).

the centre of its orbit will obviously be equal to its original value; the increase in the potential energy of the system will be equal to the work done by the extraneous forces during the displacements. From such considerations we are led to assume that the ordinary mechanics can be used in calculating the vibrations of the electrons perpendicular to the plane of the ring—contrary to the case of vibrations in the plane of the ring. This assumption is supported by the apparent agreement with observations obtained by Nicholson in his theory of the origin of lines in the spectra of the solar corona and stellar nebulae (see Part I. pp. 6 & 23). In addition it will be shown later that the assumption seems to be in agreement with experiments on dispersion.

The following table gives the values of s_n and $p_{n,o} - p_{n,m}$ from $n=1$ to $n=16$.

n ,	s_n ,	$p_{n,o} - p_{n,m}$;	n ,	s_n ,	$p_{n,o} - p_{n,m}$.
1	0	0	9	3.328	13.14
2	0.25	0.25	10	3.863	18.13
3	0.577	0.58	11	4.416	23.60
4	0.957	1.41	12	4.984	30.80
5	1.377	2.43	13	5.565	38.57
6	1.828	4.25	14	6.159	48.38
7	2.305	6.35	15	6.764	58.83
8	2.805	9.56	16	7.379	71.65

We see from the table that the number of electrons which can rotate in a single ring round a nucleus of charge Ne increases only very slowly for increasing N ; for $N=20$ the maximum value is $n=10$; for $N=40$, $n=13$; for $N=60$, $n=15$. We see, further, that a ring of n electrons cannot rotate in a single ring round a nucleus of charge ne unless $n < 8$.

In the above we have supposed that the electrons move under the influence of a stationary radial force and that their orbits are exactly circular. The first condition will not be satisfied if we consider a system containing several rings of electrons which rotate with different frequencies. If, however, the distance between the rings is not small in comparison with their radii, and if the ratio between their frequencies is not near to unity, the deviation from circular orbits may be very small and the motion of the electrons to a close approximation may be identical with that obtained on the assumption that the charge on the electrons is uniformly distributed along the circumference of the rings. If the ratio between the radii of the rings is not

near to unity, the conditions of stability obtained on this assumption may also be considered as sufficient.

We have assumed in § 1 that the electrons in the atoms rotate in coaxial rings. The calculation indicates that only in the case of systems containing a great number of electrons will the planes of the rings separate; in the case of systems containing a moderate number of electrons, all the rings will be situated in a single plane through the nucleus. For the sake of brevity, we shall therefore here only consider the latter case.

Let us consider an electric charge E uniformly distributed along the circumference of a circle of radius a .

At a point distant z from the plane of the ring, and at a distance r from the axis of the ring, the electrostatic potential is given by

$$U = -\frac{1}{\pi} E \int_0^\pi \frac{d\vartheta}{\sqrt{(a^2 + r^2 + z^2 - 2ar \cos \vartheta)}}.$$

Putting in this expression $z=0$ and $\frac{r}{a} = \tan^2 \alpha$, and using the notation

$$K(\alpha) = \int_0^{\frac{\pi}{2}} \frac{d\vartheta}{\sqrt{(1 - \sin^2 \alpha \cos^2 \vartheta)}},$$

we get for the radial force exerted on an electron in a point in the plane of the ring

$$e \frac{\partial U}{\partial r} = \frac{Ee}{r^2} Q(\alpha),$$

where

$$Q(\alpha) = \frac{2}{\pi} \sin^4 \alpha (K(2\alpha) - \cot \alpha K'(2\alpha)).$$

The corresponding force perpendicular to the plane of the ring at a distance r from the centre of the ring and at a small distance δz from its plane is given by

$$e \frac{\partial U}{\partial z} = \frac{Ee \delta z}{r^3} R(\alpha),$$

where

$$R(\alpha) = \frac{2}{\pi} \sin^6 \alpha (K(2\alpha) + \tan(2\alpha) K'(2\alpha));$$

A short table of the functions $Q(\alpha)$ and $R(\alpha)$ is given on p. 485.

Next consider a system consisting of a number of concentric

rings of electrons which rotate in the same plane round a nucleus of charge Ne . Let the radii of the rings be a_1, a_2, \dots , and the number of electrons on the different rings $n_1,$

n_2, \dots . Putting $\frac{a_r}{a_s} = \tan^2(\alpha_{r,s})$, we get for the radial force acting on an electron in the r th ring $\frac{e^2}{a_r^2} F_r$, where

$$F_r = N - s_n - \sum n_s Q(\alpha_{r,s});$$

the summation is to be taken over all the rings except the one considered.

If we know the distribution of the electrons in the different rings, from the relation (1) on p. 478, we can, by help of the above, determine a_1, a_2, \dots . The calculation can be made by successive approximations, starting from a set of values for the α 's, and from them calculating the F 's, and then redetermining the α 's by the relation (1) which

gives $\frac{F_s}{F_r} = \frac{a_r}{a_s} = \tan^2(\alpha_{r,s})$, and so on.

As in the case of a single ring it is supposed that the systems are stable for displacements of the electrons in the plane of their orbits. In a calculation such as that on p. 480, the interaction of the rings ought strictly to be taken into account. This interaction will involve that the quantities F are not constant, as for a single ring rotating round a nucleus, but will vary with the radii of the rings; the variation in F , however, if the ratio between the radii of the rings is not very near to unity, will be too small to be of influence on the result of the calculation.

Considering the stability of the systems for a displacement of the electrons perpendicular to the plane of the rings, it is necessary to distinguish between displacements in which the centres of gravity of the electrons in the single rings are unaltered, and displacements in which all the electrons inside the same ring are displaced in the same direction. The condition of stability for the first kind of displacements is given by the condition (5) on p. 481, if for every ring we replace N by a quantity G_r determined by the condition that $\frac{e^2}{a_r^3} G_r \delta z$ is equal to the component perpendicular to the plane of the ring of the force—due to the nucleus and the electrons in the other rings—acting on one of the electrons if it has received a small displacement δz . Using the same notation as above, we get

$$G_r = N - \sum n_s R(\alpha_{r,s}).$$

If all the electrons in one of the rings are displaced in the same direction by help of extraneous forces, the displacement will produce corresponding displacements of the electrons in the other rings; and this interaction will be of influence on the stability. For example, consider a system of m concentric rings rotating in a plane round a nucleus of charge Ne , and let us assume that the electrons in the different rings are displaced perpendicular to the plane by $\delta z_1, \delta z_2, \dots, \delta z_m$ respectively. With the above notation the increase in the potential energy of the system is given by

$$\frac{1}{2} N \sum n_r \frac{e^2}{a_n^3} (\delta z_r)^2 - \frac{1}{4\pi} \sum \sum n_r n_s \frac{e^2}{a_r^3} R(\alpha_{r,s}) (\delta z_r - \delta z_s)^2.$$

The condition of stability is that this expression is positive for arbitrary values of $\delta z_1, \dots, \delta z_m$. This condition can be worked out simply in the usual way. It is not of sensible influence compared with the condition of stability for the displacements considered above, except in cases where the system contains several rings of few electrons.

The following Table, containing the values of $Q(\alpha)$ and $R(\alpha)$ for every fifth degree from $\alpha = 20^\circ$ to $\alpha = 70^\circ$, gives an estimate of the order of magnitude of these functions:—

α .	$\tan^2 \alpha$.	$Q(\alpha)$.	$R(\alpha)$.
20	0.132	0.001	0.002
25	0.217	0.005	0.011
30	0.333	0.021	0.048
35	0.490	0.080	0.217
40	0.704	0.373	1.549
45	1.000
50	1.420	1.708	4.438
55	2.040	1.233	1.839
60	3.000	1.093	1.301
65	4.599	1.037	1.115
70	7.548	1.013	1.041

$\tan^2 \alpha$ indicates the ratio between the radii of the rings ($\tan^2(\alpha_{r,s}) = \frac{a_r}{a_s}$). The values of $Q(\alpha)$ show that unless the ratio of the radii of the rings is nearly unity the effect of outer rings on the dimensions of inner rings is very small, and that the corresponding effect of inner rings on outer is

to neutralize approximately the effect of a part of the charge on the nucleus corresponding to the number of electrons on the ring. The values of $R(\alpha)$ show that the effect of outer rings on the stability of inner—though greater than the effect on the dimensions—is small, but that unless the ratio between the radii is very great, the effect of inner rings on the stability of outer is considerably greater than to neutralize a corresponding part of the charge of the nucleus.

The maximum number of electrons which the innermost ring can contain without being unstable is approximately equal to that calculated on p. 482 for a single ring rotating round a nucleus. For the outer rings, however, we get considerably smaller numbers than those determined by the condition (5) if we replace Ne by the total charge on the nucleus and on the electrons of inner rings.

If a system of rings rotating round a nucleus in a single plane is stable for small displacements of the electrons perpendicular to this plane, there will in general be no stable configurations of the rings, satisfying the condition of the constancy of the angular momentum of the electrons, in which all the rings are not situated in the plane. An exception occurs in the special case of two rings containing equal numbers of electrons; in this case there may be a stable configuration in which the two rings have equal radii and rotate in parallel planes at equal distances from the nucleus, the electrons in the one ring being situated just opposite the intervals between the electrons in the other ring. The latter configuration, however, is unstable if the configuration in which all the electrons in the two rings are arranged in a single ring is stable.

§ 3. Constitution of Atoms containing very few Electrons.

As stated in § 1, the condition of the universal constancy of the angular momentum of the electrons, together with the condition of stability, is in most cases not sufficient to determine completely the constitution of the system. On the general view of formation of atoms, however, and by making use of the knowledge of the properties of the corresponding elements, it will be attempted, in this section and the next, to obtain indications of what configurations of the electrons may be expected to occur in the atoms. In these considerations we shall assume that the number of electrons in the atom is equal to the number which indicates the position of the corresponding element in the series of elements arranged in order of increasing atomic weight.

Exceptions to this rule will be supposed to occur only at such places in the series where deviation from the periodic law of the chemical properties of the elements are observed. In order to show clearly the principles used we shall first consider with some detail those atoms containing very few electrons.

For sake of brevity we shall, by the symbol $N(n_1, n_2 \dots)$, refer to a plane system of rings of electrons rotating round a nucleus of charge Ne , satisfying the condition of the angular momentum of the electrons with the approximation used in § 2. n_1, n_2, \dots are the numbers of electrons in the rings, starting from inside. By a_1, a_2, \dots and $\omega_1, \omega_2, \dots$ we shall denote the radii and frequency of the rings taken in the same order. The total amount of energy W emitted by the formation of the system shall simply be denoted by $W[N(n_1, n_2, \dots)]$.

$N=1$.

Hydrogen.

In Part I. we have considered the binding of an electron by a positive nucleus of charge e , and have shown that it is possible to account for the Balmer spectrum of hydrogen on the assumption of the existence of a series of stationary states in which the angular momentum of the electron round the nucleus is equal to entire multiples of the value $\frac{h}{2\pi}$, where h is Planck's constant. The formula found for the frequencies of the spectrum was

$$\nu = \frac{2\pi^2 e^4 m}{h^3} \left(\frac{1}{\tau_2^2} - \frac{1}{\tau_1^2} \right),$$

where τ_1 and τ_2 are entire numbers. Introducing the values for e , m , and h used on p. 479, we get for the factor before the bracket $3 \cdot 1 \cdot 10^{15}$ *; the value observed for the constant in the Balmer spectrum is $3 \cdot 290 \cdot 10^{15}$.

* This value is that calculated in the first part of the paper. Using the values $e=4 \cdot 78 \cdot 10^{-10}$ (see R. A. Millikan, Brit. Assoc. Rep. 1912, p. 410), $\frac{e}{m}=5 \cdot 31 \cdot 10^{17}$ (see P. Gmelin, *Ann. d. Phys.* xxviii. p. 1086 (1909) and A. H. Bucherer, *Ann. d. Phys.* xxxvii. p. 597 (1912)), and $\frac{e}{h}=7 \cdot 27 \cdot 10^{16}$ (calculated by Planck's theory from the experiments of E. Warburg, G. Leithäuser, E. Hupka, and C. Müller, *Ann. d. Phys.* xl. p. 611 (1913)) we get $\frac{2\pi^2 e^4 m}{h^3}=3 \cdot 26 \cdot 10^{15}$ in very close agreement with observations.

For the permanent state of a neutral hydrogen atom we get from the formula (1) and (2) in § 2, putting $F=1$,

$$1(1). \quad a = \frac{h^2}{4\pi^2 e^2 m} = 0.55 \cdot 10^{-8}, \quad \omega = \frac{4\pi^2 e^4 m}{h^3} = 6.2 \cdot 10^{15}, \\ W = \frac{2\pi^2 e^4 m}{h^2} = 2.0 \cdot 10^{-11}.$$

These values are of the order of magnitude to be expected.

For $\frac{W}{e}$ we get 0.043, which corresponds to 13 volts; the value for the ionizing potential of a hydrogen atom, calculated by Sir J. J. Thomson from experiments on positive rays, is 11 volts*. No other definite data, however, are available for hydrogen atoms. For sake of brevity, we shall in the following denote the values for a , ω , and W corresponding to the configuration 1(1) by a_0 , ω_0 and W_0 .

At distances from the nucleus, great in comparison with a_0 , the system 1(1) will not exert sensible forces on free electrons. Since, however, the configuration :

$$1(2) \quad a = 1.33 a_0, \quad \omega = 0.563 \omega_0, \quad W = 1.13 W_0,$$

corresponds to a greater value for W than the configuration 1(1), we may expect that a hydrogen atom under certain conditions can acquire a negative charge. This is in agreement with experiments on positive rays. Since $W[1(3)]$ is only 0.54, a hydrogen atom cannot be expected to be able to acquire a double negative charge.

$N=2.$

Helium.

As shown in Part I., using the same assumptions as for hydrogen, we must expect that during the binding of an electron by a nucleus of charge $2e$, a spectrum is emitted, expressed by

$$\nu = \frac{2\pi^2 m e^4}{h^3} \left(\frac{1}{\left(\frac{\tau_2}{2}\right)^2} - \frac{1}{\left(\frac{\tau_1}{2}\right)^2} \right),$$

This spectrum includes the spectrum observed by Pickering in the star ζ Puppis and the spectra recently observed by Fowler in experiments with vacuum tubes filled with a mixture of hydrogen and helium. These spectra are generally ascribed to hydrogen.

For the permanent state of a positively charged helium atom, we get

$$2(1) \quad a = \frac{1}{2} a_0, \quad \omega = 4 \omega_0, \quad W = 4 W_0.$$

* J. J. Thomson, Phil. Mag. xxiv. p. 218 (1912).

At distances from the nucleus great compared with the radius of the bound electron, the system 2(1) will, to a close approximation, act on an electron as a simple nucleus of charge e . For a system consisting of two electrons and a nucleus of charge $2e$, we may therefore assume the existence of a series of stationary states in which the electron most lightly bound moves approximately in the same way as the electron in the stationary states of a hydrogen atom. Such an assumption has already been used in Part I. in an attempt to explain the appearance of Rydberg's constant in the formula for the line-spectrum of any element. We can, however, hardly assume the existence of a stable configuration in which the two electrons have the same angular momentum round the nucleus and move in different orbits, the one outside the other. In such a configuration the electrons would be so near to each other that the deviations from circular orbits would be very great. For the permanent state of a neutral helium atom, we shall therefore adopt the configuration

$$2(2) \quad a=0.571 a_0, \quad \omega=3.06 \omega_0, \quad W=6.13 W_0.$$

Since

$$W[2(2)] - W[2(1)] = 2.13 W_0,$$

we see that both electrons in a neutral helium atom are more firmly bound than the electron in a hydrogen atom. Using the values on p. 488, we get

$$2.13 \cdot \frac{W_0}{e} = 27 \text{ volts} \quad \text{and} \quad 2.13 \frac{W_0}{h} = 6.6 \cdot 10^{15} \frac{1}{\text{sec.}};$$

these values are of the same order of magnitude as the value observed for the ionization potential in helium, 20.5 volt *, and the value for the frequency of the ultra-violet absorption in helium determined by experiments on dispersion $5.9 \cdot 10^{15} \frac{1}{\text{sec.}}$ †.

The frequency in question may be regarded as corresponding to vibrations in the plane of the ring (see p. 480). The frequency of vibration of the whole ring perpendicular to the plane, calculated in the ordinary way (see p. 482), is

* J. Franck u. G. Hertz, *Verh. d. Deutsch. Phys. Ges.* xv. p. 34 (1913).

† C. and M. Cuthbertson, *Proc. Roy. Soc. A.* lxxxiv. p. 13 (1910). (In a previous paper (*Phil. Mag.* Jan. 1913) the author took the values for the refractive index in helium, given by M. and C. Cuthbertson, as corresponding to atmospheric pressure; these values, however, refer to double atmospheric pressure. Consequently the value there given for the number of electrons in a helium atom calculated from Drude's theory has to be divided by 2.)

given by $\nu = 3.27 \omega_0$. The fact that the latter frequency is great compared with that observed might explain that the number of electrons in a helium atom, calculated by help of Drude's theory from the experiments on dispersion, is only about two-thirds of the number to be expected. (Using

$$\frac{e}{m} = 5.31 \cdot 10^{17} \text{ the value calculated is } 1.2.)$$

For a configuration of a helium nucleus and three electrons, we get

$$2(3) \quad a = 0.703 a_0, \quad \omega = 2.02 \omega_0, \quad W = 6.07 W_0.$$

Since W for this configuration is smaller than for the configuration 2(2), the theory indicates that a helium atom cannot acquire a negative charge. This is in agreement with experimental evidence, which shows that helium atoms have no "affinity" for free electrons*.

In a later paper it will be shown that the theory offers a simple explanation of the marked difference in the tendency of hydrogen and helium atoms to combine into molecules.

$$N = 3.$$

Lithium.

In analogy with the cases of hydrogen and helium we must expect that during the binding of an electron by a nucleus of charge $3e$, a spectrum is emitted, given by

$$\nu = \frac{2\pi^2 m e^4}{h^3} \left(\frac{1}{\left(\frac{\tau_2}{3}\right)^2} - \frac{1}{\left(\frac{\tau_1}{3}\right)^2} \right).$$

On account of the great energy to be spent in removing all the electrons bound in a lithium atom (see below) the spectrum considered can only be expected to be observed in extraordinary cases.

In a recent note Nicholson† has drawn attention to the fact that in the spectra of certain stars, which show the Pickering spectrum with special brightness, some lines occur the frequencies of which to a close approximation can be expressed by the formula

$$\nu = K \left(\frac{1}{4} - \frac{1}{(m \pm \frac{1}{3})^2} \right),$$

where K is the same constant as in the Balmer spectrum of hydrogen. From analogy with the Balmer- and Pickering-spectra, Nicholson has suggested that the lines in question are due to hydrogen.

* See J. Franck, *Verh. d. Deutsch. Phys. Ges.* xii. p. 613 (1910).

† J. W. Nicholson, *Month. Not. Roy. Astr. Soc.* lxxiii. p. 382 (1913).

It is seen that the lines discussed by Nicholson are given by the above formula if we put $\tau_2=6$. The lines in question correspond to $\tau_1=10, 13$, and 14 ; if we for $\tau_2=6$ put $\tau_1=9, 12$ and 15 , we get lines coinciding with lines of the ordinary Balmer-spectrum of hydrogen. If we in the above formula put $\tau=1, 2$, and 3 , we get series of lines in the ultra-violet. If we put $\tau_2=4$ we get only a single line in visible spectrum, viz.: for $\tau_1=5$ which gives $\nu=6\cdot662\cdot 10^{14}$, or a wave-length $\lambda=4503\cdot 10^{-8}$ cm. closely coinciding with the wave-length $4504\cdot 10^{-8}$ cm. of one of the lines of unknown origin in the table quoted by Nicholson. In this table, however, no lines occur corresponding to $\tau_2=5$.

For the permanent state of a lithium atom with two positive charges we get a configuration

$$3(1) \quad a = \frac{1}{3}a_0, \quad \omega = 9\omega_0, \quad W = 9W_0.$$

The probability of a permanent configuration in which two electrons move in different orbits around each other must for lithium be considered still less probable than for helium, as the ratio between the radii of the orbits would be still nearer to unity. For a lithium atom with a single positive charge we shall, therefore, adopt the configuration:

$$3(2) \quad a = 0\cdot364 a_0, \quad \omega = 7\cdot56 \omega_0, \quad W = 15\cdot13 W_0.$$

Since $W[3(2)] - W[3(1)] = 6\cdot13 W_0$, we see that the first two electrons in a lithium atom are very strongly bound compared with the electron in a hydrogen atom; they are still more rigidly bound than the electrons in a helium atom.

From a consideration of the chemical properties we should expect the following configuration for the electrons in a neutral lithium atom :

$$3(2,1) \quad \begin{array}{ll} a_1 = 0\cdot362 a_0 & \omega_1 = 7\cdot65 \omega_0 \\ a_2 = 1\cdot182 a_0 & \omega_2 = 0\cdot716 \omega_0 \end{array} \quad W = 16\cdot02 W_0.$$

This configuration may be considered as highly probable also from a dynamical point of view. The deviation of the outermost electron from a circular orbit will be very small, partly on account of the great values of the ratio between the radii, and of the ratio between the frequencies of the orbits of the inner and outer electrons, partly also on account of the symmetrical arrangement of the inner electrons. Accordingly, it appears probable that the three electrons

will not arrange themselves in a single ring and form the system :

$$3(3) \quad a = 0.413 a_0, \quad \omega = 5.87 \omega_0, \quad W = 17.61 W_0,$$

although W for this configuration is greater than for $3(2,1)$.

Since $W[3(2,1)] - W[3(2)] = 0.89 W_0$, we see that the outer electron in the configuration $3(2,1)$ is bound even more lightly than the electron in a hydrogen atom. The difference in the firmness of the binding corresponds to a difference of 1.4 volts in the ionization potential. A marked difference between the electron in hydrogen and the outermost electron in lithium lies also in the greater tendency of the latter electron to leave the plane of the orbits. The quantity G considered in § 2, which gives a kind of measure for the stability for displacements perpendicular to this plane, is thus for the outer electron in lithium only 0.55, while for hydrogen it is 1. This may have a bearing on the explanation of the apparent tendency of lithium atoms to take a positive charge in chemical combinations with other elements.

For a possible negatively charged lithium atom we may expect the configuration :

$$3(2,2) \quad \begin{array}{l} a = 0.362 a_0 \\ a = 1.516 a_0 \end{array} \quad \begin{array}{l} \omega = 7.64 \omega_0 \\ \omega = 0.436 \omega_0 \end{array} \quad W = 16.16 W_0.$$

It should be remarked that we have no detailed knowledge of the properties in the atomic state, either for lithium or hydrogen, or for most of the elements considered below.

$N=4.$

Beryllium.

For reasons analogous to those considered for helium and lithium we may for the formation of a neutral beryllium atom assume the following stages :

$$\begin{array}{llll} 4(1) & a = 0.25 a_0 & \omega = 16 \omega_0 & W = 16 W_0, \\ 4(2) & a = 0.267 a_0 & \omega = 14.06 \omega_0 & W = 28.13 W_0, \\ 4(2,1) & \begin{array}{l} a_1 = 0.263 a_0 \\ a_2 = 0.605 a_0 \end{array} & \begin{array}{l} \omega_1 = 14.46 \omega_0 \\ \omega_2 = 2.74 \omega_0 \end{array} & W = 31.65 W_0, \\ 4(2,2) & \begin{array}{l} a_1 = 0.262 a_0 \\ a_2 = 0.673 a_0 \end{array} & \begin{array}{l} \omega_1 = 14.60 \omega_0 \\ \omega_2 = 2.21 \omega_0 \end{array} & W = 33.61 W_0 ; \end{array}$$

although the configurations :

$$\begin{array}{llll} 4(3) & a = 0.292 a_0 & \omega = 11.71 \omega_0 & W = 35.14 W_0, \\ 4(4) & a = 0.329 a_0 & \omega = 9.26 \omega_0 & W = 37.04 W_0. \end{array}$$

correspond to less values for the total energy than the configurations 4 (2, 1) and 4 (2, 2).

From analogy we get further for the configuration of a possible negatively charged atom,

$$4(2,3) \quad \begin{array}{ll} a_1 = 0.263 a_0 & \omega_1 = 14.51 \omega_0 \\ a_2 = 0.803 a_0 & \omega_2 = 1.55 \omega_0 \end{array} \quad W = 33.66 W_0.$$

Comparing the outer ring of the atom considered with the ring of a helium atom, we see that the presence of the inner ring of two electrons in the beryllium atom markedly changes the properties of the outer ring; partly because the outer electrons in the configuration adopted for a neutral beryllium atom are more lightly bound than the electrons in a helium atom, and partly because the quantity G , which for helium is equal to 2, for the outer ring in the configuration 4 (2, 2) is only equal to 1.12.

Since $W[4(2,3)] - W[4(2,2)] = 0.05 W_0$, the beryllium atom will further have a definite, although very small affinity for free electrons.

§ 4. Atoms containing greater numbers of electrons.

From the examples discussed in the former section it will appear that the problem of the arrangement of the electrons in the atoms is intimately connected with the question of the confluence of two rings of electrons rotating round a nucleus outside each other, and satisfying the condition of the universal constancy of the angular momentum. Apart from the necessary conditions of stability for displacements of the electrons perpendicular to the plane of the orbits, the present theory gives very little information on this problem. It seems, however, possible by the help of simple considerations to throw some light on the question.

Let us consider two rings rotating round a nucleus in a single plane, the one outside the other. Let us assume that the electrons in the one ring act upon the electrons in the other as if the electric charge were uniformly distributed along the circumference of the ring, and that the rings with this approximation satisfy the condition of the angular momentum of the electrons and of stability for displacements perpendicular to their plane.

Now suppose that, by help of suitable imaginary extraneous forces acting parallel to the axis of the rings, we pull the inner ring slowly to one side. During this process, on account of the repulsion from the inner ring, the outer will move to the opposite side of the original plane of the rings.

During the displacements of the rings the angular momentum of the electrons round the axis of the system will remain constant, and the diameter of the inner ring will increase while that of the outer will diminish. At the beginning of the displacement the magnitude of the extraneous forces to be applied to the original inner ring will increase but thereafter decrease, and at a certain distance between the plane of the rings the system will be in a configuration of equilibrium. This equilibrium, however, will not be stable. If we let the rings slowly return they will either reach their original position, or they will arrive at a position in which the ring, which originally was the outer, is now the inner, and *vice versa*.

If the charge of the electrons were uniformly distributed along the circumference of the rings, we could by the process considered at most obtain an interchange of the rings, but obviously not a junction of them. Taking, however, the discrete distribution of the electrons into account, it can be shown that, in the special case when the number of electrons on the two rings are equal, and when the rings rotate in the same direction, the rings will unite by the process, provided that the final configuration is stable. In this case the radii and the frequencies of the rings will be equal in the unstable configuration of equilibrium mentioned above. In reaching this configuration the electrons in the one ring will further be situated just opposite the intervals between the electrons in the other, since such an arrangement will correspond to the smallest total energy. If now we let the rings return to their original plane, the electrons in the one ring will pass into the intervals between the electrons in the other, and form a single ring. Obviously the ring thus formed will satisfy the same condition of the angular momentum of the electrons as the original rings.

If the two rings contain unequal numbers of electrons the system will during a process such as that considered behave very differently, and, contrary to the former case, we cannot expect that the rings will flow together, if by help of extraneous forces acting parallel to the axis of the system they are displaced slowly from their original plane. It may in this connexion be noticed that the characteristic for the displacements considered is not the special assumption about the extraneous forces, but only the invariance of the angular momentum of the electrons round the centre of the rings; displacements of this kind take in the present theory a similar position to arbitrary displacements in the ordinary mechanics.

The above considerations may be taken as an indication that there is a greater tendency for the confluence of two rings when each contains the same number of electrons. Considering the successive binding of electrons by a positive nucleus, we conclude from this that, unless the charge on the nucleus is very great, rings of electrons will only join together if they contain equal numbers of electrons; and that accordingly the numbers of electrons on inner rings will only be 2, 4, 8, If the charge of the nucleus is very great the rings of electrons first bound, if few in number, will be very close together, and we must expect that the configuration will be very unstable, and that a gradual interchange of electrons between the rings will be greatly facilitated.

This assumption in regard to the number of electrons in the rings is strongly supported by the fact that the chemical properties of the elements of low atomic weight vary with a period of 8. Further, it follows that the number of electrons on the outermost ring will always be odd or even, according as the total number of electrons in the atom is odd or even. This has a suggestive relation to the fact that the valency of an element of low atomic weight always is odd or even according as the number of the element in the periodic series is odd or even.

For the atoms of the elements considered in the former section we have assumed that the two electrons first bound are arranged in a single ring, and, further, that the two next electrons are arranged in another ring. If $N \geq 4$ the configuration $N_{(4)}$ will correspond to a smaller value for the total energy than the configuration $N_{(2,2)}$. The greater the value of N the closer will the ratio between the radii of the rings in the configuration $N_{(2,2)}$ approach unity, and the greater will be the energy emitted by an eventual confluence of the rings. The particular member of the series of the elements for which the four innermost electrons will be arranged for the first time in a single ring cannot be determined from the theory. From a consideration of the chemical properties we can hardly expect that it will have taken place before boron ($N=5$) or carbon ($N=6$), on account of the observed trivalency and tetravalency respectively of these elements; on the other hand, the periodic system of the elements strongly suggests that already in neon ($N=10$) an inner ring of eight electrons will occur. Unless $N \geq 14$ the configuration $N_{(4,4)}$ corresponds to a smaller value for the total energy than the configuration $N_{(8)}$; already

for $N \geq 10$ the latter configuration, however, will be stable for displacements of the electrons perpendicular to the plane of their orbits. A ring of 16 electrons will not be stable unless N is very great; but in such a case the simple considerations mentioned above do not apply.

The confluence of two rings of equal number of electrons, which rotate round a nucleus of charge Ne outside a ring of n electrons already bound, must be expected to take place more easily than the confluence of two similar rings rotating round a nucleus of charge $(N-n)e$; for the stability of the rings for a displacement perpendicular to their plane will (see § 2) be smaller in the first than in the latter case. This tendency for stability to decrease for displacements perpendicular to the plane of the ring will be especially marked for the outer rings of electrons of a neutral atom. In the latter case we must expect the confluence of rings to be greatly facilitated, and in certain cases it may even happen that the number of electrons in the outer ring may be greater than in the next, and that the outer ring may show deviations from the assumption of 1, 2, 4, 8 electrons in the rings, *e. g.* the configurations 5 (2, 3) and 6 (2, 4) instead of the configurations 5 (2, 2, 1) and 6 (2, 2, 2). We shall here not discuss further the intricate question of the arrangement of the electrons in the outer ring. In the scheme given below the number of electrons in this ring is arbitrarily put equal to the normal valency of the corresponding element; *i. e.* for electronegative and electropositive elements respectively the number of hydrogen atoms and twice the number of oxygen atoms with which one atom of the element combines.

Such an arrangement of the outer electrons is suggested by considerations of atomic volumes. As is well known, the atomic volume of the elements is a periodic function of the atomic weights. If arranged in the usual way according to the periodic system, the elements inside the same column have approximately the same atomic volume, while this volume changes considerably from one column to another, being greatest for columns corresponding to the smallest valency 1 and smallest for the greatest valency 4. An approximate estimate of the radius of the outer ring of a neutral atom can be obtained by assuming that the total force due to the nucleus and the inner electrons is equal to that from a nucleus of charge ne , where n is the number of electrons in the ring. Putting $F = n - s_n$ in the equation (1) on p. 478, and denoting the value of a for $n=1$ by a_0 , we get for $n=2$, $a = 0.57a_0$; for $n=3$, $a = 0.41a_0$; and for $n=4$, $a = 0.33a_0$. Accordingly the arrangement chosen

for the electrons will involve a variation in the dimensions of the outer ring similar to the variation in the atomic volumes of the corresponding elements. It must, however, be borne in mind that the experimental determinations of atomic volumes in most cases are deduced from consideration of molecules rather than atoms.

From the above we are led to the following possible scheme for the arrangement of the electrons in light atoms:—

1 (1)	9 (4, 4, 1)	17 (8, 4, 4, 1)
2 (2)	10 (8, 2)	18 (8, 8, 2)
3 (2, 1)	11 (8, 2, 1)	19 (8, 8, 2, 1)
4 (2, 2)	12 (8, 2, 2)	20 (8, 8, 2, 2)
5 (2, 3)	13 (8, 2, 3)	21 (8, 8, 2, 3)
6 (2, 4)	14 (8, 2, 4)	22 (8, 8, 2, 4)
7 (4, 3)	15 (8, 4, 3)	23 (8, 8, 4, 3)
8 (4, 2, 2)	16 (8, 4, 2, 2)	24 (8, 8, 4, 2, 2)

Without any fuller discussion it seems not unlikely that this constitution of the atoms will correspond to properties of the elements similar with those observed.

In the first place there will be a marked periodicity with a period of 8. Further, the binding of the outer electrons in every horizontal series of the above scheme will become weaker with increasing number of electrons per atom, corresponding to the observed increase of the electropositive character for an increase of atomic weight of the elements in every single group of the periodic system. A corresponding agreement holds for the variation of the atomic volumes.

In the case of atoms of higher atomic weight the simple assumptions used do not apply. A few indications, however, are suggested from consideration of the variations in the chemical properties of the elements. At the end of the 3rd period of 8 elements we meet with the iron-group. This group takes a particular position in the system of the elements, since it is the first time that elements of neighbouring atomic weights show similar chemical properties. This circumstance indicates that the configurations of the electrons in the elements of this group differ only in the arrangement of the inner electrons. The fact that the period in the chemical properties of the elements after the iron-group is no longer 8, but 18, suggests that elements of higher atomic weight contain a recurrent configuration of 18 electrons in the innermost rings. The deviation from

2, 4, 8, 16 may be due to a gradual interchange of electrons between the rings, such as is indicated on p. 495. Since a ring of 18 electrons will not be stable the electrons may be arranged in two parallel rings (see p. 486). Such a configuration of the inner electrons will act upon the outer electrons in very nearly the same way as a nucleus of charge $(N-18)e$. It might therefore be possible that with increase of N another configuration of the same type will be formed outside the first, such as is suggested by the presence of a second period of 18 elements.

On the same lines, the presence of the group of the rare earths indicates that for still greater values of N another gradual alteration of the innermost rings will take place. Since, however, for elements of higher atomic weight than those of this group, the laws connecting the variation of the chemical properties with the atomic weight are similar to those between the elements of low atomic weight, we may conclude that the configuration of the innermost electrons will be again repeated. The theory, however, is not sufficiently complete to give a definite answer to such problems.

§ 5. Characteristic Röntgen Radiation.

According to the theory of emission of radiation given in Part I., the ordinary line-spectrum of an element is emitted during the reformation of an atom when one or more of the electrons in the outer rings are removed. In analogy it may be supposed that the characteristic Röntgen radiation is sent out during the settling down of the system if electrons in inner rings are removed by some agency, *e.g.* by impact of cathode particles. This view of the origin of the characteristic Röntgen radiation has been proposed by Sir J. J. Thomson*.

Without any special assumption in regard to the constitution of the radiation, we can from this view determine the minimum velocity of the cathode rays necessary to produce the characteristic Röntgen radiation of a special type by calculating the energy necessary to remove one of the electrons from the different rings. Even if we knew the numbers of electrons in the rings, a rigorous calculation of this minimum energy might still be complicated, and the result largely dependent on the assumptions used; for, as mentioned in Part I., p. 19, the calculation cannot be performed entirely on the basis of the ordinary mechanics. We can, however, obtain very simply an approximate comparison

* Comp. J. J. Thomson, Phil. Mag. xxiii. p. 456 (1912).

with experiments if we consider the innermost ring and as a first approximation neglect the repulsion from the electrons in comparison with the attraction of the nucleus. Let us consider a simple system consisting of a bound electron rotating in a circular orbit round a positive nucleus of charge Ne . From the expressions (1) on p. 478 we get for the velocity of the electron, putting $F=N$,

$$v = \frac{2\pi e^2}{h} N = 2 \cdot 1 \cdot 10^8 N.$$

The total energy to be transferred to the system in order to remove the electron to an infinite distance from the nucleus is equal to the kinetic energy of the bound electron. If, therefore, the electron is removed to a great distance from the nucleus by impact of another rapidly moving electron, the smallest kinetic energy possessed by the latter when at a great distance from the nucleus must necessarily be equal to the kinetic energy of the bound electron before the collision. The velocity of the free electron therefore must be at least equal to v .

According to Whiddington's experiments* the velocity of cathode rays just able to produce the characteristic Röntgen radiation of the so-called K-type—the hardest type of radiation observed—from an element of atomic weight A is for elements from Al to Se approximately equal to $A \cdot 10^8$ cm./sec. As seen this is equal to the above calculated value for v , if we put $N = \frac{A}{2}$.

Since we have obtained approximate agreement with experiment by ascribing the characteristic Röntgen radiation of the K-type to the innermost ring, it is to be expected that no harder type of characteristic radiation will exist. This is strongly indicated by observations of the penetrating power of γ rays†.

It is worthy of remark that the theory gives not only nearly the right value for the energy required to remove an electron from the outer ring, but also the energy required to remove an electron from the innermost ring. The approximate agreement between the calculated and experimental values is all the more striking when it is recalled that the energies required in the two cases for an element of atomic weight 70 differ by a ratio of 1000.

In connexion with this it should be emphasized that the

* R. Whiddington, Proc. Roy. Soc. A. lxxxv. p. 323 (1911).

† Comp. E. Rutherford, Phil. Mag. xxiv. p. 453 (1912).

remarkable homogeneity of the characteristic Röntgen radiation—indicated by experiments on absorption of the rays, as well as by the interference observed in recent experiments on diffraction of Röntgen rays in crystals—is in agreement with the main assumption used in Part I. (see p. 7) in considering the emission of line-spectra, viz. that the radiation emitted during the passing of the systems between different stationary states is homogeneous.

Putting in (4) $F=N$, we get for the diameter of the innermost ring approximately $2a = \frac{1}{N} \cdot 10^{-8}$ cm. For $N = 100$ this gives $2a = 10^{-10}$ cm., a value which is very small in comparison with ordinary atomic dimensions but still very great compared with the dimensions to be expected for the nucleus. According to Rutherford's calculation the dimensions of the latter are of the same order of magnitude as 10^{-12} cm.

§ 6. *Radioactive Phenomena.*

According to the present theory the cluster of electrons surrounding the nucleus is formed with emission of energy, and the configuration is determined by the condition that the energy emitted is a maximum. The stability involved by these assumptions seems to be in agreement with the general properties of matter. It is, however, in striking opposition to the phenomena of radioactivity, and according to the theory the origin of the latter phenomena may therefore be sought elsewhere than in the electronic distribution round the nucleus.

A necessary consequence of Rutherford's theory of the structure of atoms is that the α -particles have their origin in the nucleus. On the present theory it seems also necessary that the nucleus is the seat of the expulsion of the high-speed β -particles. In the first place, the spontaneous expulsion of a β -particle from the cluster of electrons surrounding the nucleus would be something quite foreign to the assumed properties of the system. Further, the expulsion of an α -particle can hardly be expected to produce a lasting effect on the stability of the cluster of electrons. The effect of the expulsion will be of two different kinds. Partly the particle may collide with the bound electrons during its passing through the atom. This effect will be analogous to that produced by bombardment of atoms of other substances by α -rays and cannot be expected to give rise to a subsequent expulsion of β -rays. Partly the expulsion of the particle

will involve an alteration in the configuration of the bound electrons, since the charge remaining on the nucleus is different from the original. In order to consider the latter effect let us regard a single ring of electrons rotating round a nucleus of charge Ne , and let us assume that an α -particle is expelled from the nucleus in a direction perpendicular to the plane of the ring. The expulsion of the particle will obviously not produce any alteration in the angular momentum of the electrons; and if the velocity of the α -particle is small compared with the velocity of the electrons—as it will be if we consider inner rings of an atom of high atomic weight—the ring during the expulsion will expand continuously, and after the expulsion will take the position claimed by the theory for a stable ring rotating round a nucleus of charge $(N-2)e$. The consideration of this simple case strongly indicates that the expulsion of an α -particle will not have a lasting effect on the stability of the internal rings of electrons in the residual atom.

The question of the origin of β -particles may also be considered from another point of view, based on a consideration of the chemical and physical properties of the radioactive substances. As is well known, several of these substances have very similar chemical properties and have hitherto resisted every attempt to separate them by chemical means. There is also some evidence that the substances in question show the same line-spectrum*. It has been suggested by several writers that the substances are different only in radio-active properties and atomic weight but identical in all other physical and chemical respects. According to the theory, this would mean that the charge on the nucleus, as well as the configuration of the surrounding electrons, was identical in some of the elements, the only difference being the mass and the internal constitution of the nucleus. From the considerations of § 4 this assumption is already strongly suggested by the fact that the number of radioactive substances is greater than the number of places at our disposal in the periodic system. If, however, the assumption is right, the fact that two apparently identical elements emit β -particles of different velocities, shows that the β -rays as well as the α -rays have their origin in the nucleus.

This view of the origin of α - and β -particles explains very simply the way in which the change in the chemical properties of the radioactive substances is connected with the

* See A. S. Russell and R. Rossi, Proc. Roy. Soc. A. lxxxvii. p. 478 (1912).

nature of the particles emitted. The results of experiments are expressed in the two rules * :—

1. Whenever an α -particle is expelled the group in the periodic system to which the resultant product belongs is two units less than that to which the parent body belongs.

2. Whenever a β -particle is expelled the group of the resultant body is 1 unit greater than that of the parent.

As will be seen this is exactly what is to be expected according to the considerations of § 4.

In escaping from the nucleus, the β -rays may be expected to collide with the bound electrons in the inner rings. This will give rise to an emission of a characteristic radiation of the same type as the characteristic Röntgen radiation emitted from elements of lower atomic weight by impact of cathode-rays. The assumption that the emission of γ -rays is due to collisions of β -rays with bound electrons is proposed by Rutherford † in order to account for the numerous groups of homogeneous β -rays expelled from certain radioactive substances.

In the present paper it has been attempted to show that the application of Planck's theory of radiation to Rutherford's atom-model through the introduction of the hypothesis of the universal constancy of the angular momentum of the bound electrons, leads to results which seem to be in agreement with experiments.

In a later paper the theory will be applied to systems containing more than one nucleus.

XXXVIII. *On the Collapse of Tubes by External Pressure.*
—II. *By* R. V. SOUTHWELL, B.A., *Fellow of Trinity College, Cambridge* ‡.

IN the issue of this Magazine for May 1913 § I have dealt with the effects of circular ends upon the resistance of tubes to collapse by external pressure, and in a somewhat fuller discussion of the same problem || I have shown that my results are well supported by experiment, so far as the

* See A. S. Russell, *Chem. News*, cvii. p. 49 (1913); G. v. Hevesy, *Phys. Zeitschr.* xiv. p. 49 (1913); K. Fajans, *Phys. Zeitschr.* xiv. pp. 131 & 136 (1913); *Verh. d. deutsch. Phys. Ges.* xv. p. 240 (1913); F. Soddy, *Chem. News*, cvii. p. 97 (1913).

† E. Rutherford, *Phil. Mag.* xxiv. pp. 453 & 893 (1912).

‡ Communicated by the Author.

§ Vol. xxv. pp. 687-698.

|| "On the General Theory of Elastic Stability," *Phil. Trans. Roy. Soc. A.* vol. ccxiii. pp. 187-244 (1913).

relative strengths of long and short tubes are concerned. The theoretical formula is not, however, satisfactory as a basis for practical design, since the results of careful experiments * have shown that it over-estimates, often by a very considerable amount, the resistance of actual tubes to collapse. I propose in the present paper to investigate whether these discrepancies can be accounted for. If so, it may be possible to substitute rational estimates of strength for the purely empirical formulæ which are at present employed.

I shall here consider in detail only tubes which exceed what Professor Carman has called "the critical length." This term may be explained by a reference to the general expression for the collapsing pressure †, which may be written as follows:—

$$\mathfrak{P} = 2E \frac{t}{d} \left[\frac{Z}{k^4(k^2-1)} \cdot \frac{d^4}{l^4} + \frac{1}{3} \frac{m^2}{m^2-1} (k^2-1) \frac{t^2}{d^2} \right] \quad (1)$$

where

\mathfrak{P} is the collapsing pressure, in pounds per square inch;

E is Young's modulus, in pounds per square inch,

and $\frac{1}{m}$ is Poisson's ratio, for the material of the tube;

t is the thickness,

d is the diameter,

and l is the length of the tube between end-constraints;

k is the number of lobes characterizing the cross-section after collapse,

and Z is a constant, depending upon the type of the end-constraints.

It is easily seen † that as the length l is increased, the pressure required to produce collapse, for any definite value of k , falls rapidly to a sensibly constant value, given by

$$\mathfrak{P} = \frac{2}{3} \frac{m^2}{m^2-1} E (k^2-1) \frac{t^3}{d^3}, \quad \dots \quad (2)$$

and since this expression has its least possible value when $k=2$, we are led by theory to predict that all tubes of

* A. P. Carman, University of Illinois Bulletin, vol. iii. No. 17; R. T. Stewart, Am. Soc. Mech. Eng. Transactions, pp. 730-820 (1906).

† Cf. my papers cited above.

considerable length will collapse into a two-lobed form, and at sensibly the same pressure, of amount

$$\mathfrak{P}_c = 2 \frac{m^2}{m^2 - 1} E \frac{t^3}{d^3} \dots \dots \dots (3)$$

This is the theoretical formula for the collapsing pressure of a tube of infinite length, first given by Professor Bryan*.

Except as regards the numerical value of the collapsing pressure, these conclusions are well supported by the results of experiment †, which show that after a certain limit, generally termed "the critical length," has been reached, no appreciable change in the strength of a tube results from a further increase of its length. Hence, the formula (3) may fairly be compared with the results of experiments on tubes of finite length, provided only that this "critical length" is exceeded.

The experiments of Carman and Stewart have provided full and accurate data for the comparison, and they leave no room for doubt that tubes of practical dimensions and material will collapse under pressures very much less than the formula (3) suggests. This, however, is not surprising if we remember that the formula is based upon the assumption that the elasticity of the material is perfect at the instant of collapse, whereas the pressure given by (3) will be more than sufficient to produce elastic break-down in tubes of ordinary material, unless these are very thin.

If this is a correct explanation of the discrepancy between theory and experiment, we shall expect to find that the formula (3) is supported best by experiments on very thin tubes, and this is actually the case. On the other hand, if practical imperfections of form and material were the chief causes of weakness, as has sometimes been suggested, it would be reasonable to look for closest agreement to experiments on thick tubes, in which greater accuracy of workmanship may be expected. Similar considerations apply in the case of the strut problem. Euler's formula gives its closest predictions of strength in the case of long struts, which are comparatively difficult to load with accuracy, and this fact makes it unlikely that its untrustworthiness in the case of shorter struts is due mainly to practical imperfections.

* Proc. Camb. Phil. Soc. vol. vi. p. 287 (1888).

† Cf. Carman and Stewart, *loc. cit.*, and the experimental curve given in my second paper (footnote ||, p. 502).

I have shown * that Euler's theory may be extended so as to apply to cases in which the collapsing thrust is more than sufficient to produce elastic break-down of the strut, and it is found that by this extension close agreement with experimental results may be obtained for struts of any length and material. Euler's formula, for a free-ended strut, is

$$pA = \pi^2 \frac{EI}{l^2} \quad (4)$$

where

- p is the intensity of compressive stress at collapse ;
- A is the area,
- and I is the moment of inertia of the cross-section of the strut ;
- l is the length,
- and E is Young's modulus for the material of the strut.

This is amended by reducing l , the length which, according to (4), corresponds to a given compressive stress p , in the ratio

$$\frac{2}{1 + \sqrt{\frac{E}{E'}}}, \quad (5)$$

where E' is the ratio

$$\text{Lt. } \left[\frac{\text{Increase of stress}}{\text{Increase of strain}} \right],$$

for the material under consideration, corresponding to the stress p ; it is given by the slope of the ordinary stress-strain diagram for a compression test at the point which corresponds to p , and has the value E , Young's modulus for the material, when p is below the elastic limit of the material. The analysis leading to this amendment is fully explained in the papers cited above.

Since an infinitely long tube collapses under external pressure in a manner which has many points of resemblance to strut failure, it is reasonable to hope for equally good results from a similar extension of Bryan's formula. The two problems, in fact, are almost identical †. This is made clear by a consideration of the form of the cross-section

* 'Engineering,' Aug. 23, 1912 ; Phil. Trans. Roy. Soc. A. vol. cxxiii. pp. 187-244 (1913).

† Cf. W. C. Unwin, Proc. Inst. C.E. vol. xlvi. p. 225 (1875) ; W. E. Lilly, Trans. Inst. Civ. Eng. Ireland (1910).

when held by the collapsing pressure in a position of slight distortion, defined by the analysis leading to equation (3). The form of the cross-section, before and after distortion, is shown in fig. 1 : the curvature is increased and decreased

Fig. 1.

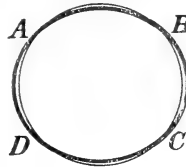

The thick line shows form of cross-section after distortion.

at different parts of the section, and at four equidistant points (A, B, C, D in the figure) it remains unchanged by collapse. Moreover, in the initial configuration the action on any section of the tube wall is very nearly a uniform compressive stress. Hence the tube may be regarded as composed of four circular struts, pin-jointed at their extremities, and of circumferential length $\frac{1}{4}\pi d$. If we consider a unit length of the tube, the cross-section of each strut is a rectangle, of dimensions $1 \times t$, and the thrust, which at every point acts along the centre line of the strut, is $\frac{1}{2}\mathfrak{P}_c d$. Euler's theory would give for the collapsing load

$$\frac{1}{2} \mathfrak{P}_c d = \pi^2 E \cdot \frac{t^3}{12} \cdot \frac{16}{\pi^2 d^2},$$

or
$$\mathfrak{P}_c = \frac{8}{3} E \cdot \frac{t^3}{d^3}, \dots \dots \dots (6)$$

and the amended equation, for cases in which elastic breakdown precedes collapse, would be

$$\mathfrak{P}_c = \frac{32}{3} \cdot \frac{E}{\left(1 + \sqrt{\frac{E}{E'}}\right)^2} \cdot \frac{t^3}{d^3}, \dots \dots \dots (7)$$

where E' corresponds to p , the circumferential compressive stress (or $\frac{1}{2} \mathfrak{P}_c \frac{d}{t}$), in the manner described above.

Comparing the expression (6) with (3), we see that it is correct in form, but needs to be multiplied by the factors $\frac{3}{4}$ and $\frac{m^2}{m^2 - 1}$. The former represents the relative weakness of the circular as compared with a straight strut, and does

not depend upon the elastic properties of the material. On the other hand, since it involves m , the latter factor will be changed when the limit of elasticity has been exceeded: it represents the additional strength of a long tube due to the prevention in it of what is known as "anticlastic curvature," and its value after elastic breakdown cannot be easily predicted; but it is certainly greater than, and differs only by a small amount from unity, and may therefore be neglected with safety.

From these considerations we are led to the following general formula for the collapsing pressure:—

$$P_c = \frac{8E}{\left(1 + \sqrt{\frac{E}{E'}}\right)^2} \cdot \frac{t^3}{d^3}, \quad \dots \quad (8)$$

where E' is given by the slope of the compressive stress-strain diagram at a stress equal to $\frac{1}{2} P_c \frac{d}{t}$. If the latter diagram is known for the material under consideration, we can by this equation readily construct a curve which will give estimates of the strength of tubes.

Fig. 2.—Collapsing Pressures of Seamless Brass Tubes.

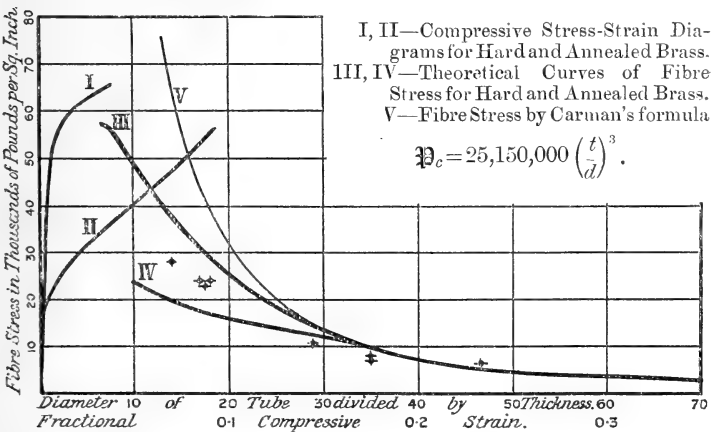

The application of these methods to the present problem is illustrated in figs. 2 and 3, in which the results of Carman's experiments on seamless brass and steel tubes * are compared

* *Loc. cit.*, Tables V. and III. It was thought that Stewart's results, which were derived from tests of lap-welded tubes, were less suited to the purpose of the present paper.

with curves derived by the above theory from the stress-strain diagrams of compression tests. The latter, drawn on the left-hand sides of the figures, are representative diagrams for hard and annealed brass and steel, as given in any text-book. In the case of fig. 2, the Curve V is first drawn to represent the circumferential compressive stress, or "fibre stress," from the equation *

$$p = 12,575,000 \frac{t^2}{d^2}, \quad (9)$$

and the Curves III and IV are obtained from this. Fig. 2 illustrates clearly a point which the present paper is intended especially to emphasize, *i. e.* the danger of undue reliance in design upon experimental estimates of the resistance of drawn tubes to collapse, owing to the transitory nature of that part of their strength against buckling which they possess in virtue of the hardening processes of manufacture. Exact analyses and stress-strain diagrams of the brass composing his tubes were not published by Professor Carman, but it is clear that the process of drawing would tend to harden the material at points close to the surface, so that the experimental results may be expected to agree more and more closely with the theoretical Curve III (which is drawn for a homogeneous tube of hard brass) as the proportion of material affected by the drawing process increases. In other words, we should expect that in the case of any actual tube they will give points lying between Curves III and IV, and this is found to be the case. But if the tube be subjected to practical conditions tending to anneal it, we may expect that it will approach more and more nearly a limit which is represented by the Curve IV. Imperfect circularity and want of uniformity in thickness or material will, as in every case, result in further weakening, and we are therefore led to the conclusion that by employing in design formulæ which have been obtained from hydraulic testing apparatus, we are making serious over-estimates of strength, unless we can rely upon the maintenance under practical conditions of the high elastic limit which is induced by the drawing process.

I am not competent to say exactly how far the treatment to which boiler-flues are subjected in practice will tend to anneal them; but it would appear that the only safe course is to allow for thorough annealing, and to regard the estimates given by Curve IV for the strength of brass flues as absolute

* Equation (9) was given by Carman for thin tubes. The numerical coefficient is quite a representative value of E for brass.

maxima, only obtainable under ideally perfect conditions*. It is remarkable that the actual values obtained from tests on new tube (in cold water) are so largely in excess of these, in spite of the effects of imperfect circularity and uniformity of thickness, which Professor Slocum † has shown to be important.

Fig. 3.—Collapsing Pressures of Seamless Steel Tubes.

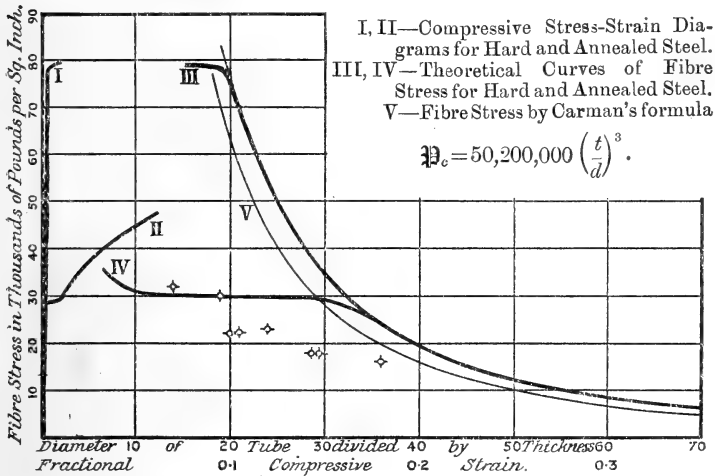

Exactly similar considerations apply to steel tubes, and are illustrated in fig. 3. Curve V is drawn to represent the equation

$$p = 25,100,000 \frac{t^2}{d^2}, \dots \dots \dots (7)$$

the numerical coefficient being an estimate drawn by Carman from his experimental results. In constructing the theoretical Curves III and IV a more representative value for E has been taken. We are confronted by the difficulty that no stress-strain diagrams were published by Carman for the materials of his tests. The want is more seriously felt in connexion with this figure, owing to the greater diversity in quality of steels as compared with brasses, and more especially

* Flue-tubes may be overheated if the water-level is allowed to fall unduly; and although they may be saved from immediate collapse if the pressure is relieved, the annealing thus induced may, according to the above theory, reduce their fitness for future service, in a way which has been overlooked.

† "The Collapse of Tubes by External Pressure," Engineering, Jan. 8, 1909.

to the importance of the yield-point as a criterion of collapse*. In the light of the above discussion we can see why the group-averages of Professor Carman's results, as shown in fig. 3, should be so irregularly distributed; for his analyses show a percentage of carbon in his seamless steel tubes ranging from 0.17 to 0.22, and this variation cannot fail to affect the yield-point.

Being at present engaged upon an experimental investigation into the influence of length upon the strength of boiler-flues, I have thought it worth while to employ my apparatus for testing the conclusions of this paper. Steel tubes of the same thickness and diameter, both annealed and as received from the mills, and in several lengths, were tested, and the results are given in the following table. Care was taken to see, by measurement with a micrometer, that the process of annealing had not affected the circularity of the tubes, and the comparative weakness of the annealed specimens may therefore be attributed solely to the lowering of the elastic limit. The tubes (1 inch external diameter; 0.028 inch thick) were tested under hydraulic pressure, the end thrust due to this pressure being left unbalanced, and the results are shown in the appended table.

Comparative Strengths of Annealed and Unannealed Tubing.

Length of Tube between End Plugs. (Inches.)	No. of Tests.		Collapsing Pressure of Annealed Tube.	Collapsing Pressure of Unannealed Tube.	Strength Ratio.
	Annealed.	Unannealed.			
8.69	1	1	1008 lbs. per sq. in. (mean).	1270 lbs. per sq. in. (mean).	1.26
6.19	3	2	1255 " " "	1575 " " "	1.25
4.19	2	1	1827 " " "	2400 " " "	1.31

It will be seen that these results lend strong support to the foregoing theory, which discards the idea of any difference in the methods of failure of thick and of thin tubes, at

* Owing to the fact that the compressive "hoop" stress, in fairly thick tubes, is not distributed quite uniformly across a section of the tube wall, the curve of fibre-stress will scarcely be so flat as the methods of this paper would indicate.

any rate within the range of sizes tested by Carman and Stewart, and thus rejects the "crushing formula" of Lamé*. In my opinion, Lamé's theory should be restricted to the failure of tubes by *internal* pressure, and any practical size of tube, if subjected to external pressure, will fail by instability. The foregoing theory leaves untouched the difficult problem of determining the strengthening effects of circular ends in cases where elastic breakdown precedes collapse; but this is a question of theoretical rather than practical interest, for it would be dangerous in any case to allow the material to be stressed up to the yield-point, and this restriction limits the permissible pressure, in the case of a short tube of ordinary dimensions, to a value for which there is no danger of collapse by instability.

I wish to acknowledge my indebtedness to Messrs. H. J. Howard and D. P. Scott, for assistance in the prosecution of the experiments described above, and to Messrs. Stewart and Lloyds, Ltd., of Glasgow, for gifts of steel tubes for test. These tubes exceeded all expectations in point of accuracy and uniformity of material.

July 2nd, 1913.

XXXIX. *Experiments on Columnar Ionization.* By E. M. WELLISCH, *Assistant Professor of Physics, Yale University,* and J. W. WOODROW, *Ph.D., Yale University* †.

INTRODUCTION.

1. IN their experiments on the distribution of the active deposit of radium in an electric field, Wellisch and Bronson ‡ found that the fraction of the total amount of active deposit that settled on the cathode increased with the potential-difference in a manner quite similar to the increase of the electric current which passed through the gas during the process of activation. The curve connecting the cathode activity and the potential-difference exhibited the characteristic "lack of saturation" which had previously been investigated by Bragg, Moulin, and others in the case of the electric current due to alpha-ray ionization. This experimental result suggested the probability that the electric current would attain its saturation value only when all the

* S. E. Slocum, *loc. cit.*, equation (2).

† Communicated by the Authors.

‡ Wellisch & Bronson, *Phil. Mag.* [6] xxiii. p. 714, May 1912.

active deposit settled on the cathode; or more generally that the cathode activity was a measure of the degree of saturation of the electric current.

On investigating experimentally the activity distribution when the radium emanation was present in air at a pressure of 260 mm., it was found that for potentials above 80 volts the cathode activity did not perceptibly increase; but the curves connecting the percentage of cathode activity and the ionization with the potential-difference had the characteristic horizontal portion which suggests that saturation has been attained. On the other hand, the measurements showed that there was still about 17 per cent. of the active deposit which failed to reach the cathode.

These experimental results appeared to indicate that the saturation obtained for alpha particle ionization at pressures below about one-half of an atmosphere was only apparent: the results were most suitably explained on the supposition that part of the electric current observed at one atmosphere was due to the ionization by collision with molecules which, though electrically neutral, had been brought into an unstable condition by the action of the alpha particle. These "neutrons" would be in the most favourable position for ionization when the electric field was parallel to the alpha-ray column and also when the pressure was not too low.

On this view, the characteristic upward slope of the curve connecting the electric current with the field for alpha particle ionization is due in part to the extra ionization thus obtained. We should expect, therefore, that when the electric force is sufficiently great the electric current would be slightly greater when the field is longitudinal or parallel to the alpha-particle column than when it is transverse or perpendicular to it. The present paper describes a series of experiments which were devised to compare the ionization resulting from a longitudinal and transverse field for the case of a single alpha particle column. The results of the experiments confirm the accepted view of the phenomenon as advanced by Langevin and Moulin*, namely that the "lack of saturation" of the ionization current is due to the columnar recombination, and no evidence was obtained which would indicate the existence of unstable atoms in the alpha-ray columns.

In Section 5, some theoretical considerations based on Langevin's theory of recombination are given in which the subject is treated from a slightly different standpoint from that adopted by Moulin.

* Moulin, *Compt. Rend.* cxlviii. p. 1757 (1909).

DESCRIPTION OF THE EXPERIMENTAL METHOD.

2. It was first shown by Moulin that lack of saturation does not come into evidence when the field is transverse to the alpha-ray column nor, at low pressures, when the field is longitudinal. This experimental fact formed the basis of the method employed for the comparison of the ionization resulting from the application of a longitudinal and a transverse field to a single alpha particle column.

Consider a single alpha particle column formed in air (1) at a pressure of one atmosphere, (2) at a pressure p which is a small fraction of an atmosphere, say about one-third. Let i_1 and i_2 denote the number of ions due to a small portion of the path (in the present case this was 4 mm. in length) for the two pressures respectively. This ionization may be measured with either a longitudinal or a transverse field. Let

$$\frac{i_1}{i_2} = r_l \quad \text{and} \quad \frac{i_1}{i_2} = r_t$$

when the ionization is measured in a longitudinal and transverse field respectively.

In general, r_l will be different from r_t : this arises from the fact that the current at one atmosphere when measured in the longitudinal field depends upon the electric field over a wide range, while in the other the currents readily assume values which are independent of the field.

On the hypothesis of Wellisch and Bronson it was to be expected that r_l would be greater than r_t for large values of the field; whereas on the Langevin-Moulin theory r_l should be less than r_t , except when saturation was attained, in which case we should have $r_l = r_t$.

In order to determine the value of r_l corresponding to any value of the field, the ionization currents due to the alpha rays from a polonium source were measured in a longitudinal field for air at one atmosphere and for air at a lower pressure p . The ratio of these currents gives the value of r_l and is independent of the actual number of alpha particles entering the measuring apparatus and also of the electrical capacity of the system; in fact it is the ratio which would be obtained for the ionization due to a single alpha particle.

The ratio r_t was determined in a similar manner by obtaining the corresponding currents in the transverse field.

Description of Apparatus and Experimental Procedure.

3. By the kind permission of Prof. Bumstead we were enabled to avail ourselves of the ionization vessel which had

previously been employed by Wheelock* in his experiments on alpha-ray ionization. A general idea of the apparatus and the general scheme of connexions may be obtained from fig. 1. For the vertical longitudinal field the ionization vessel consisted of a wire gauze B, 7.5 cm. in diameter, situated 4 mm. below a circular brass plate A, which was connected to one pair of quadrants of a Dolezalek electrometer. The lower gauze G was inserted as usual, to avoid disturbances due to diffusion of ions into the region AB.

Fig. 1.

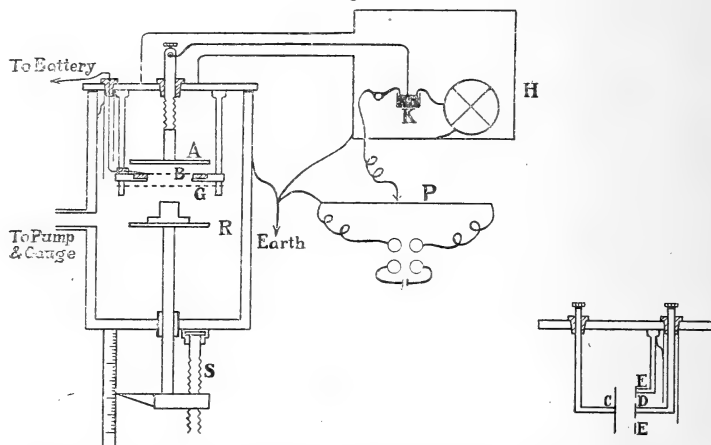

For the horizontal transverse field two brass plates were employed, one C (8.5×2.5 cm.) connected to the battery, and the other D (7.2×0.4 cm.), which connected with the electrometer. The latter electrode was surrounded by an earthed plate E, which served as a guard ring.

Both the longitudinal and the transverse fields were so constructed that they could be inserted in the same containing vessel as shown in the diagram.

A thin film of polonium deposited on a copper plug, 4 mm. in diameter, which had been prepared previously by Prof. Boltwood, was employed as the alpha-ray source. This plug was placed on the carrier R, which could be moved vertically by a screw, S. A scale and divided head enabled one to make a very accurate determination of the distance of the polonium from the centre of the ionization vessel. A narrow beam of alpha rays was always employed; this was obtained by placing over the polonium a fine slit or a series of fine "canals" as described below.

* Wheelock, *Am. J. Sci.* [4] xxx. p. 233 (1910).

The electrometer was of the Dolezalek pattern with a platinum suspension, and had a sensibility of 140 mm. per volt with 84 volts on the needle.

In most of the experiments a potentiometer arrangement was employed so that the reading of the ionization current might be made with the zero of the instrument at the centre of the swing. It was found that this method gave very consistent and accurate readings, which was of especial importance when small potentials were employed.

The whole apparatus could be rendered gas-tight by the use of a heavy stop-cock grease.

Experimental Results.

4. In the first set of observations a fine slit 5 mm. long and 0.5 mm. in width was placed 1 cm. above the surface of the polonium. A "Bragg" curve was determined in the usual manner by varying the distance of the polonium from the electrodes. The range of the alpha particle in air at one atmosphere or a pressure of 760 mm. of mercury was found to be 3.8 cm., which is in good agreement with that observed by Levin* and Taylor†. When the transverse field was employed the slit was so orientated that its length was parallel to the electrodes. It was calculated that the cone of rays emerging from the slit would fall entirely within the electrodes and that no alpha particle could reach an electrode except by scattering.

The values obtained for r_l and r_t for different values of the electric field X are given below, and the corresponding

TABLE I.

$$d = 2.68 \text{ cm.}; r = i_{760}/i_{284}.$$

p. mm.	Longitudinal Field.			Transverse Field.		
	X volts/cm.	i_l	r_l	X.	i_t	r_t
160	1565	0.65	...	625	0.43	...
284	1565	1.22	...	625	0.82	...
770	25	3.51	2.88	4	1.91	2.33
770	50	3.88	3.18	20	2.53	3.09
770	105	4.05	3.32	42	2.80	3.42
770	525	4.46	3.66	125	2.99	3.65
770	1045	4.53	3.71	210	2.96	3.62
770	1575	4.61	3.78	625	2.98	3.64

* Levin, Am. J. Sci. [4] xxii. p. 8 (1906).

† Taylor, *ibid.* [4] xxvi. p. 169 (1908).

curves are given in fig. 2. The values given for the ratio r are for the ratio of the current at a pressure of 760 mm. to that at a pressure of 284 mm. The distance $d=2.68$ cm. is that from the polonium to the middle of the ionization vessel. This notation will be used throughout the present paper. The current is in scale-divisions per second.

Fig. 2.

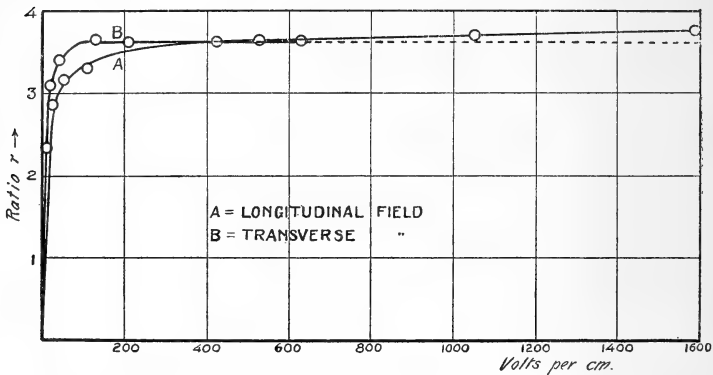

It will be seen from fig. 2 that for values of X greater than 400 volts per centimetre r_l is greater than r_t . This experimental result was verified in several subsequent determinations and appeared thus to support the view that there is extra ionization produced when the electric field is longitudinal.

The slit was now removed and in its place was inserted a "canal" system consisting of twenty-five small holes drilled in a small brass rod 6 mm. in length and 4 mm. in diameter. There was a central "canal" 1 mm. in diameter surrounded by twenty-four smaller "canals," each 0.4 mm. in diameter. In this manner the electric field was more rigorously longitudinal or transverse to the alpha particle trajectories than when the slit was employed. A value was obtained for the range of the alpha particle identical with that found previously.

The values obtained for r_l and r_t are given in Table II., and the corresponding curves are shown in fig. 3.

In order to determine whether the scattering of the alpha particles produced any effect on the relative values of r_l and r_t when the canals were employed, readings were taken of the current with the polonium at different distances from the middle of the ionization vessel. The electric

TABLE II.

$$d = 2.6 \text{ cm. ; } r = i_{760}/i_{261}.$$

p.	Longitudinal Field.			Transverse Field.		
	X.	i_l .	r_l .	X.	i_t .	r_t .
261	1580	0.385	...	630	0.435	...
400	1580	0.610	...	530	0.685	...
760	105	1.13	2.94	42	1.48	3.40
760	420	1.26	3.28	210	1.54	3.54
760	1050	1.32	3.43	420	1.53	3.52
760	1580	1.34	3.48	630	1.53	3.52

Fig. 3.

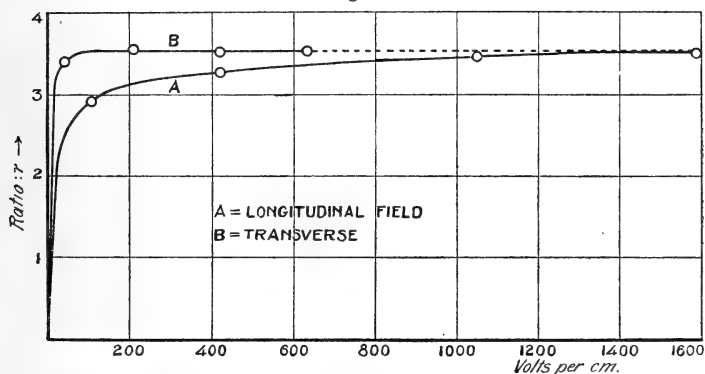

field was 1580 volts per centimetre for both the longitudinal and the transverse fields. The results are shown in Table III.

TABLE III.

$$X_l = 1580 \text{ volts/cm. ; } X_t = 630 \text{ volts/cm. ; } r = i_{760}/i_{284}.$$

d.	r_l .	r.	d.	r_t .	r_t .
3.2 cm.	3.04	3.08	2.8 cm.	3.27	3.34
3.0 cm.	3.30	3.37	2.6 cm.	3.11	3.28

It will be seen now that in every case the value of r_t is greater than the corresponding value of r_l . The curves of fig. 3 tend to the same maximum value, namely, 3.53.

In order to ascertain the reason for the discrepancy between the results obtained when the slit and the canals were employed, experiments were performed in which only small portions of the slit previously employed were effective. The oblique rays were eliminated by placing narrow pieces of brass over the ends of the slit so as to leave an opening in the centre 1.7 mm. in length and 0.5 mm. in width. The corresponding values of r_l and r_t are given in Table IV.: it will be seen that the ratios for the longitudinal and transverse fields have approximately the same maximum values. The results thus serve to confirm those obtained when the canals were employed.

TABLE IV.

$$d = 2.68 \text{ cm. ; } r = i_{760}/i_p.$$

<i>p.</i>	Longitudinal Field.			Transverse Field.		
	X.	i_l .	r_l .	X.	i_t .	r_t .
284 mm.	1580	0.560	3.42	630	0.391	3.40
400	1580	0.828	2.24	630	0.588	2.27
596	1580	1.370	1.40	630	0.962	1.38
760	1580	1.914	1.00	630	1.330	1.00

The narrow brass pieces were now removed from the ends of the slit and a brass plate 2 mm. in width was placed over the central portion of the slit so that now the ionization was mostly due to the oblique rays. The values of r_l and r_t are tabulated in Table V. The fact that r_l is much greater than

TABLE V.

$$\text{Oblique rays. } d = 2.68 \text{ cm. ; } r = i_{760}/i_{284}.$$

<i>p.</i>	Longitudinal Field.			Transverse Field.		
	X.	i_l .	r_l .	X.	i_t .	r_t .
284	1580	0.917	...	630	0.808	...
760	420	3.04	3.31	630	2.55	3.16
760	1580	3.15	3.45

r_t for high values of the electric field shows that the oblique rays were responsible for the small values of r_t relatively to those of r_l when the whole slit was employed as described above.

In order to examine more closely the effect when the oblique rays alone were made effective by eliminating those from the central portion of the slit, readings were taken of the ionization current for different gas-pressures in both the longitudinal and transverse fields. From the figures given in Table VI., one sees that the increase of the current with the pressure is quite normal in the case of the longitudinal field, but that the current at a pressure of 760 mm. of mercury in the transverse field shows a distinct falling off from the normal law. This result was surprising in view of the calculations for the position of the cone of rays emerging from the slit. It indicates probably that an appreciable fraction of the alpha particles are scattered into the electrodes of the transverse field, thus diminishing the ionization current. In the longitudinal field there would not be a diminution of the current, as the particles would be merely scattered in the gas.

TABLE VI.

Oblique rays. $d=2.68$ cm.; $X_l=1580$; $X_t=630$.

p .	i_l .	i_t .	i_l/p .	i_t/p .	i_l/i_t .
mm.					
153	0.47	0.41	3.07×10^{-3}	2.68×10^{-3}	1.14
232	0.73	0.65	3.14 ,,	2.80 ,,	1.12
261	0.84	0.74	3.22 ,,	2.84 ,,	1.13
284	0.92	0.81	3.24 ,,	2.85 ,,	1.13
370	1.24	1.10	3.36 ,,	2.98 ,,	1.13
400	1.36	1.21	3.40 ,,	3.03 ,,	1.12
446	1.56	1.39	3.50 ,,	3.12 ,,	1.12
596	2.25	1.99	3.77 ,,	3.34 ,,	1.13
760	3.15	2.55	4.15 ,,	3.38 ,,	1.23

The experimental results obtained when the rays were canalized are thus the only results which admit of strict interpretation; and they show that r_l and r_t both tend to the same maximum value. In other words, in accordance

with the view generally accepted, the current resulting from alpha-ray ionization has the same saturation value whether the electric field is longitudinal or transverse, the continued slope of the ionization curve for the longitudinal field being due entirely to "lack of saturation" occasioned by the recombination of ions.

It is worthy of mention here that experiments were performed to determine the shape of the ionization curve in the longitudinal field at pressures of about 10 mm. of mercury when the electric field was sufficiently increased to produce ionization by collision. The curve obtained was that to be expected from Townsend's theory and no evidence of any anomalous behaviour was observed.

Having proved to our satisfaction that the characteristic shape of the ionization curve for the longitudinal field was to be ascribed entirely to the effect of recombination of ions, it became a point of interest to ascertain if possible the relative effects of columnar and volume recombination. Moulin* has already given a method for determining the shape of the current-field curve when volume recombination is absent, that is, when no recombination takes place between ions formed in different columns. Moulin's method consisted in determining the effect of volume recombination by comparing the curve obtained for a transverse field with that obtained by using X-rays as the ionizing source. The ideal curve corresponding to absence of volume recombination in a longitudinal field was obtained by means of a series of calculations referred to the ideal curve of the transverse field.

In the present experiments a more direct method was employed to obtain these ideal curves for a longitudinal field. This method consisted in determining how the fraction (i/I) of the saturation current (I) which corresponds to any given value of the electric field depends upon the value of this saturation current. Three sources of polonium were employed and a fourth determination was possible as a result of an appreciable decay of the weakest of these sources. In fig. 4 are given curves which show how i/I varies with I for different values of X in the longitudinal field. The curves are plotted from the values given in Table VII. These curves are produced so as to intersect the axis of ordinates: the ordinates thus cut off represent the fraction of the saturation current which would be obtained by the

* Moulin, *Ann. Chim. Phys.* [8] xxii. p. 26 (1911).

corresponding field in the absence of any recombination between ions of different columns.

Fig. 4.

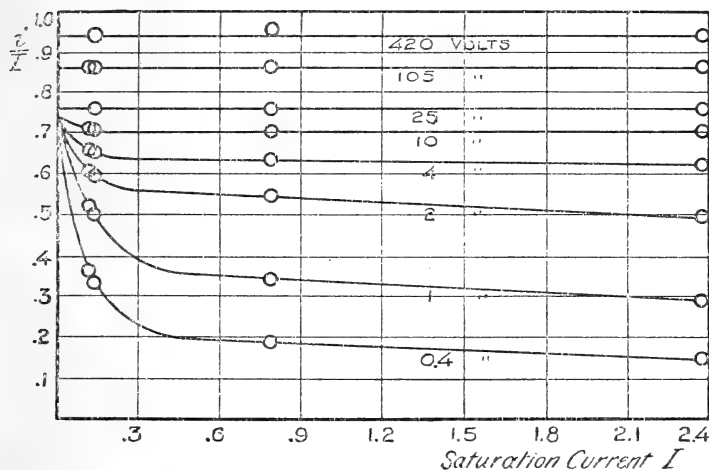

TABLE VII.

Longitudinal Field. $d=2.6$ cm. ; $p=760$ mm.

X.	0.4	1.0	2.0	4.0	10	25	105	420	I.
i/I .	.36	.52	.605	.658	.710	.76	.86	.94	0.12
i/I .	.33	.50	.595	.654	.708	.76	.86	...	0.13
i/I .	.19	.34	.548	.635	.704	.76	.86	.96	0.78
i/I .	.15	.29	.498	.623	.704	.76	.86	.94	2.39

Transverse Field. $d=2.6$ cm. ; $p=760$ mm.

X.	0.4	0.8	2.0	4.0	10	26	40	I.
i/I .	.25	.44	.68	.775	.872	.94	.98	0.44
i/I .	.09	.16	.38	.645	.816	.93	.97	2.40
i/I .	.05	.10	.25	.490	.783	.92	.97	6.99

It might be expected that as there are only four points on each curve it would be very difficult to produce the curves as stated above, especially those curves corresponding to small values of the field: however, those points which were of the most importance for our subsequent calculations were those which were most readily obtained by this method. Moreover, other considerations made it highly probable that the curves corresponding to the small values of the electric field intersected the axis of ordinates at points close to one another.

In fig. 5 the limiting values of i/I obtained as above described are plotted against the corresponding values of

Fig. 5.

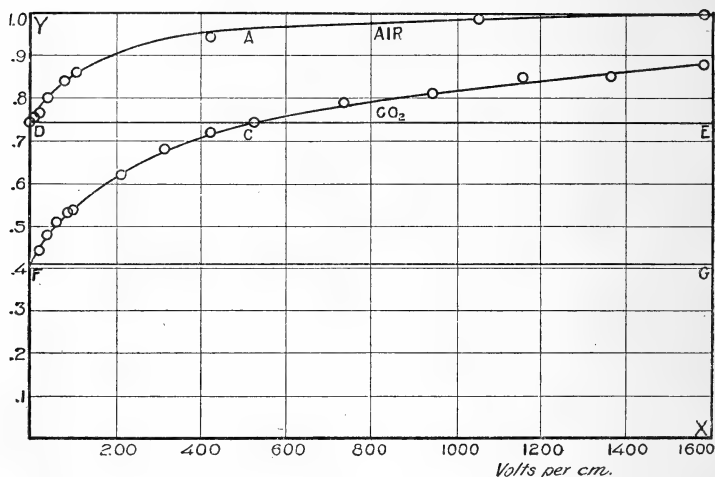

the electric field. This curve refers to the longitudinal field in air at a pressure of 760 mm. of mercury, and may be considered as giving the fraction of the total ionization produced by a single alpha particle which is carried over to the electrodes by the corresponding electric field. The curve is practically identical with that obtained by Moulin*; it intersects the axis of ordinates at a point represented by the fraction 0.74. The ideal curve for the transverse electric field could not be obtained with the same degree of accuracy, but it is approximately a straight line parallel to the X-axis and with 1.0 as ordinate indicating that a very small value of the field is sufficient to prevent recombination of the ions.

* Moulin, *loc. cit.* p. 99.

In fig. 5 is also given a curve obtained by the direct measurement of the ionization current in the longitudinal field when the gas in the vessel was CO_2 (carefully dried) at a pressure of 750 mm. of mercury, the polonium being at a distance of 1.75 cm. from the centre of the ionization vessel. This curve represents very accurately the limiting curve for CO_2 , corresponding to the ionization by a single alpha particle. It seemed unnecessary to obtain the limiting points in the manner employed in the case of air, inasmuch as the shape of the curve for CO_2 is determined almost entirely by values of the electric field which are easily able to prevent volume recombination. This curve was also in good agreement with that obtained by Moulin. The saturation current for CO_2 was not obtainable experimentally; its value was calculated by means of a formula given by Langevin, as is indicated in the following section.

THEORETICAL CONSIDERATIONS.

5. According to the view brought forward by Moulin* the saturation current is obtained for alpha-ray ionization only when the component of the electric field perpendicular to the alpha particle column has a value which is sufficient to separate the ions before recombination occurs. After the column has been formed two effects are operative which tend to separate the ions; namely diffusion combined with molecular agitation, and the transverse component of the electric field. Moulin distinctly states that a field strictly longitudinal has no effect in breaking up the columns; that the reason the saturation current is attained in practice for longitudinal fields is that these fields really have a component perpendicular to the trajectories. He has also shown by calculations based on the geometrical conditions of his apparatus, that when the saturation current is attained in such a longitudinal field the transverse component of the field has the same value as would be necessary to secure saturation in a transverse field. With a field which is strictly longitudinal on his view we should obtain only that fraction of the saturation current which is due to diffusion. Curve A, fig. 5, shows that this fraction is approximately 0.74 for air at a pressure of one atmosphere, which is in good agreement with the value previously found by Moulin.

The excellent agreement which Moulin obtains between theory and experiment lends strong support to this view: at the same time we would like to indicate briefly a possible

* *L. c.* p. 80.

manner in which the ionization curve may be explained by introducing the part played by a strictly longitudinal field in preventing recombination. The fact that the shape of the curve obtained experimentally by us when the longitudinal field was employed is in such good agreement with that obtained by Moulin, although the method of canalizing the rays was quite different (in the present case the extreme rays made an angle with the normal less than two-thirds the corresponding angle in Moulin's experiments), suggests that the longitudinal field does play a part in preventing recombination.

As stated previously, the curve A, fig. 5, gives us the "ideal" curve corresponding to the ionization produced by a single alpha particle in a longitudinal field. The fact that a very small field whose value is just large enough to direct the ions brings 74 per cent. of the ions to the electrodes shows that this percentage of the ions must escape quickly from the column as a result of diffusion and molecular agitation.

Let us draw through the point D, where the curve A intersects the axis of ordinates, a straight line DE parallel to the axis of X. If we now refer the curve A to DE and DY as axes, we may regard this curve as being a new saturation curve resulting from the application of increasing longitudinal fields to those ions in the column which have not been separated by the process of diffusion. Langevin's theory of recombination affords a ready means of testing the truth of this supposition. According to this theory, if the gas between two parallel electrodes is ionized by a single flash of rays of very short duration, then the quantity of electricity Q received at the electrodes corresponding to any field $X=4\pi\sigma$ is given by

$$\frac{\epsilon Q}{\sigma} = \log_e \left(1 + \frac{\epsilon Q_0}{\sigma} \right) , \quad \quad (1)$$

where Q_0 is the total quantity of electricity liberated per sq. cm. of cross-section and ϵ is a proper fraction which Langevin found by experiment to have the value 0.27 for air at a pressure of one atmosphere. If we revert to the case of a single alpha particle the time which it spends in ionizing is extremely small, and if we suppose the initial separation of the ions due to molecular agitation to be extremely rapid we have the ideal conditions for applying Langevin's theory of recombination.

In order to test the applicability of this theory, Langevin's equation was put in the form

$$y = \frac{1}{x} \log_e(1+x), \dots \dots \dots (2)$$

where

$$y = Q/Q_0 \text{ and } x = \frac{\epsilon Q_0}{\sigma}.$$

Corresponding values of y and σ were chosen at various points along the curve A, fig. 5 ; from the value of y that of x was obtained by computation, using equation (2), and then, making use of the relation $x = \frac{\epsilon Q_0}{\sigma}$, Q_0 was determined. The values of Q_0 obtained by choosing different values for y should be constant. A set of values determined in this way is given in Table VIII. The values of Q_0 are given in arbitrary units.

TABLE VIII.
Different Positions of the Axis.

y .	.73.		.74.		.75.	
	X Volts/cm.	Q_0 .	X.	Q_0 .	X.	Q_0 .
0.46	75	66.3	90	79.6	105	92.8
0.55	140	82.5	150	88.3	160	94.3
0.61	190	84.0	195	86.1	210	92.8
0.66	230	81.3	245	86.6	250	88.3
0.75	338	74.9	350	77.2	360	79.6
0.81	460	67.8	550	81.0	520	76.6

In order to obtain an idea of the sensibility of the method, two other straight lines parallel to DE and close to it were chosen as axes. The values of Q_0 obtained by choosing different values for y along the curve A when the axes were at 0.73, 0.74, and 0.75 are given in the above table. It will be seen that the values for the axis at 0.74 are more nearly constant than for the other two positions of this axis. With the axes farther away, the values differ much more ; that is, the values of Q_0 are more nearly constant even for the large values of y when the axis is chosen so as to pass through

the point where the curve appears to intersect the axis of ordinates.

Taking the straight line DE as the axis, the average of the values obtained for Q_0 is 82.3, which when reduced to E. S. units gives $Q_0=0.274$. Taylor* has determined the total number of ions produced by a single alpha particle from polonium in air at a pressure of one atmosphere: his calculations give this number to be 164,000. The ratio of the area of that portion of the "Bragg" ionization curve, included between the two ordinates corresponding to distances 2.4 cm. and 2.8 cm. from the polonium, to the total area enclosed by the curve and the axes, was found to be 0.112. Then each alpha particle will produce $0.112 \times 164,000 = 18,368$ pairs of ions in the ionization vessel employed in the experiments described above, where the polonium was 2.6 cm. from the centre of the vessel. Let S be the cross-sectional area of a column; then assuming uniform ionization within the column the total charge liberated by a single alpha particle in the region considered is

$$\frac{100}{26} SQ_0 = \frac{27.4}{26} S = 18368 \times 4.65 \times 10^{-10},$$

whence

$$S = 8.10 \times 10^{-6} \text{ cm.}^2$$

and the radius of the cross-section becomes

$$R = 0.0016 \text{ cm.}$$

In the application of the theory to CO_2 , as the saturation current could not be obtained experimentally, recourse was had to the method described by Langevin† in his original paper. The ionization curve for CO_2 was drawn with electric field as abscissæ and current as ordinates: the curve was then produced to intersect the axis of ordinates. The straight line through this point parallel to the X-axis was taken as the new axis and the method of Langevin for finding ϵ was then applied. A large curve given by the equation $y = \frac{1}{x} \log(1+x)$ was plotted with $\log(x)$ as abscissæ and $\log(y)$ as ordinates. The value of the current (measured from the new axis) for an electric field of 1575 volts per cm. was taken as Q' and then from different values of $\log(Q'/Q)$ corresponding to values of $\log(X'/X) = \log(\sigma'/\sigma)$, $\log(x)$ and $\log(y)$ could be read off on this curve. The

* Taylor, *Phil. Mag.* [6] xxiii. p. 670 (1912).

† Langevin, *Ann. Chim. Phys.* [7] xxviii. p. 458 (1903).

determinations thus made of ϵ from the equation $\epsilon = xy \frac{\sigma}{Q}$ (in arbitrary units) for different values of X are given in Table IX. From this mean value of $\epsilon = 2032$, it was possible to determine by the use of equation (1) the value of the saturation current. The value given in Table IX. for

TABLE IX.

X	200	400	600	800	1000	∞
Q	0.181	0.260	0.301	0.331	0.356	0.525
ϵ	2030	1930	2050	1960	2190	...

$X = \infty$ was obtained in this way; and this value was employed in plotting the curve C, fig. 5, which is seen to intersect the axis of ordinates at the point corresponding to the fraction 0.41.

The value Q_0 of the saturation current per sq. cm. for a single column can be readily deduced after the curve C has been plotted. Langevin found that for CO_2 at a pressure of one atmosphere $\epsilon = 0.51$; the values of y and x were obtained corresponding to a field of 200 volts per cm. and Q_0 was then deduced by means of the relation $x = \frac{\epsilon Q_0}{\sigma}$. The value obtained was .551 E. S. unit. The ionization current in CO_2 was measured at the same relative part of the range of the alpha particle as that in air; and assuming that the total ionization in CO_2 is 1.03 times that in air, it was easy to calculate the number of ions produced by each alpha particle within the ionization vessel. The calculation gave the area of cross-section $S = 1.42 \times 10^{-5}$ cm.² and the radius of the column $R = 0.0021$ cm.

The large values obtained for the mean cross-section of the columns may at first appear surprising. Professor Bumstead* has already suggested that a considerable part of the ionization in the columns may be indirect and be due to the action of electrons liberated from the atoms by the action of the alpha particle. These electrons would have a range of the order of 0.1 mm. in air at a pressure of one atmosphere. Apart from this suggestion, however, it should be remembered that the cross-section is that of the column after the ions have in considerable measure been separated by the processes of diffusion and molecular agitation. After the

* Bumstead & McGougan, Phil. Mag. [6] xxiv. p. 482 (1912).

column has been formed by the alpha particle there would in all probability be an extremely rapid lateral diffusion of the ions, so that before the ions have sensibly moved under the action of the electric field we may regard the column as consisting of a core (which in air at one atmosphere contains about 26 per cent. of the ions) surrounded by a fringe. The recombination occurs mainly in the core.

If Langevin's theory is indeed applicable as the above considerations would appear to indicate, this would afford a further proof that the recombination in the alpha particle columns is between ions formed from different atoms and is not the initial recombination in the sense originally understood by Bragg, viz., that between an electron and its parent atom. It is probable that such initial recombination does actually occur, but it does not appear to be prevented to any appreciable extent by the electric fields employed in ordinary laboratory practice.

Summary.

(1) A method was devised to compare the ionization due to a single alpha particle when measured in a longitudinal and transverse field. The results confirm the view of Moulin and Langevin that the upward slope characteristic of the alpha-ray ionization curve when a longitudinal field is employed, is due entirely to recombination of ions in the column. The suggestion of Wellisch and Bronson that the slope is due in part to ionization by collision is shown to be untenable.

(2) It is shown that Langevin's theory of recombination appears to be applicable to the ionization produced by a single alpha particle; also the theory enables an estimate of the mean cross-section of the column to be computed.

Sloane Laboratory, Yale University,
June 4, 1913.

XL. *The Disintegration of Uranium X.* By ALEXANDER FLECK, B.Sc., Assistant in the Department of Physical Chemistry, Glasgow University*.

THE only direct disintegration product of uranium that is generally accepted is uranium X. Two other products were described by Danne † and Antonoff ‡, but the existence

* Communicated by Frederick Soddy, M.A., F.R.S.

† Danne, *Compt. Rend.* cxlviii. p. 337 (1909); *Le Radium*, vi. p. 42 (1909).

‡ Antonoff, *Phil. Mag.* [6] xxii. p. 419 (1911).

of neither of these substances has yet been confirmed. The theoretical considerations put forward almost simultaneously regarding the evolution of the radio-elements through the periodic law by Russell *, Fajans †, and Soddy ‡ led to the belief that one other substance should exist before ionium, and in a short paper published by Fajans and Göhring § the discovery of such a body is announced. It is called by the authors "uranium X₂"; its period of half-value is stated as 1.1 minutes, and the only method of separation given is that of placing a lead plate in a weakly acid solution of uranium X. On removing the plate and measuring its activity a rapid initial fall was observed. By a method not stated the rise of β activity from a uranium X preparation was also observed. The name uranium X₁ was given to the substance with the period of average life of 35.5 days. The object of the work that will be described in this paper was to attempt to confirm the existence of this short-lived radio-element, and this has been successfully done. The term uranium X will be used to denote uranium X₁ in equilibrium with uranium X₂.

The deposition of uranium X on metallic plates was studied, and it was found that when a plate of gold or platinum was placed in a weakly acid solution of uranium X no detectable quantity of activity was obtained on the plate. Measurable quantities of uranium X were, however, obtained by placing zinc and magnesium plates in such a solution. When the activity of such plates was measured no initial rapid decay was observed. If, however, a plate of lead was used a rapid initial decay was obtained. The method employed was to cut a flat clean plate of lead just smaller than the base of a flat-bottomed crystallizing dish in which the lead was placed. The solution of uranium X was made just acid with nitric acid, and, occupying not more than 5 c.c., was then poured over the plate, and the liquid kept agitated for five minutes. The lead plate was then withdrawn, drained, and washed in alcohol which was finally removed by burning. When cool the plate was immediately taken to an electro-scope and the hard β activity measured, the first measurement being usually made from one and a half to two minutes after the instant of withdrawal of the lead plate from the uranium X solution. It was then found that after six or

* Russell, *Chem. News*, cvii. p. 49 (1913).

† Fajans, *Physikal. Zeitsch.* xiv. p. 131 (1913); *Ber.* xlv. p. 422 (1913).

‡ Soddy, *Chem. News*, cvii. p. 97 (1913); *Jahrb. Radioaktiv. Elektronik.* x. p. 188 (1913).

§ Fajans & Göhring, *Die Naturwissenschaften*, 4th April, 1913, Heft xiv. p. 339.

seven minutes the activity of the plate was only from 60 to 80 per cent. of the initial activity, and this activity remained constant over a number of hours. By drawing the difference curve obtained by subtracting this constant activity it was seen to be approximately exponential, and that the radiation decayed to half-value in from one to one and a half minutes. Fajans and Göhring's experiment has therefore been repeated and confirmed.

If lead chloride is precipitated with hydrochloric acid in a uranium X solution, the precipitate collected and its activity measured, then this rapid initial decay is again observed. The proportional decay is usually about the same as in the case of the lead plate, but sometimes amounts to about 50 per cent. of the initial activity. In both of these experiments the quantity of activity precipitated with the lead is small compared with the total quantity present.

That this rapid decay is not due to diffusion or other physical cause connected with the lead was shown in two ways. A tray of thin lead-foil was made, into which a weakly acid solution of uranium X was placed, and after five minutes the solution was removed. The tray, washed and dried in the usual way with alcohol, was then placed under the electroscope in an inverted position. If the effect previously observed had been due to diffusion, then, when the β activity of the tray was measured in an inverted position, an initial rise should have been observed. No such rise was seen, but, on the contrary, the same rapid initial decay was observed. Radium E gives off β rays not greatly differing from those of uranium X, and if the effect had been due to any action of the rays on lead, it would have been expected that it would have been obtained on precipitating lead chloride in a strong solution of radium E. When this was done no rapid initial decay was observed in the β activity of the precipitate.

Experiments were made by precipitating bismuth oxychloride in a uranium X solution, and the curve obtained by measuring the β activity of one such precipitate is shown in fig. 1, along with the logarithmic curve obtained by subtracting the final activity reached after nine minutes from the activity at any time. It is seen that the activity of 52 divs. per min., measured two minutes after precipitation, decays to an activity of 6.5 divs. per min., showing that the substance is in a relatively pure condition. The period of average life calculated from three values of this curve is 1.44, 1.83, and 1.63 minutes—an average value of 1.627 minutes. By extrapolating this curve backwards to the instant of

precipitation it is found that at that moment the activity would be 158.5 divs. per min. A small quantity of thorium was added to the filtrate from this bismuth oxychloride precipitate and precipitated as oxalate. Measured after

Fig. 1.

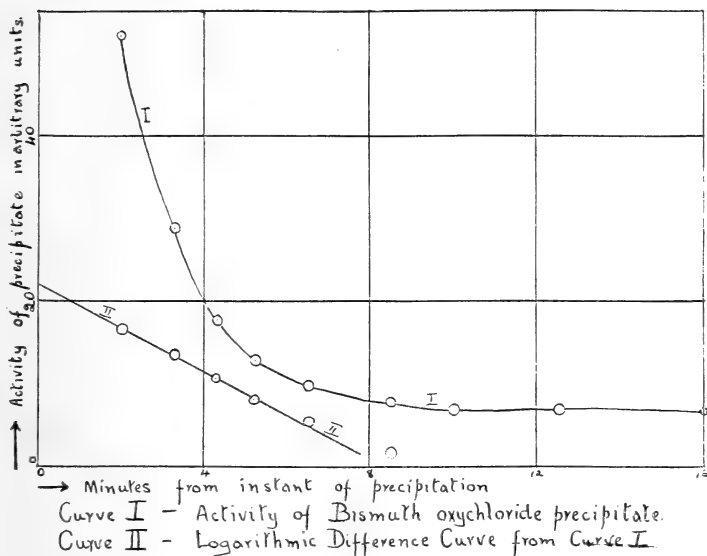

some hours the activity of this oxalate precipitate was 167.1 divs. per min. Thus it is shown that 94.5 per cent. of the equilibrium amount of the hard β rays of uranium X had been removed. A large number of experiments have been made trying to repeat this separation, but it has never been effected with the same completeness. Two or three times, however, by adding water to a strongly acid solution of uranium X a slight precipitate, or sometimes merely a cloudiness, has been obtained, and on filtering the liquid the paper was found to have an activity which decayed to nearly zero in eight minutes. The period of average life of the substance when calculated from these curves was found to be from 1.4 to 1.7 minutes. The period of average life of the substance may therefore be taken as 1.6 minutes. This agrees well with Fajans and Göhring's period of half-value of 1.1 minutes.

The form of the difference decay curves is the same whether the preparation is measured through 0.1 mm. or 0.0034 mm. thick aluminium foil, but in the latter case,

when the soft β rays are operative, the constant value reached is relatively much greater.

Uranium X_2 is also obtained in considerable excess over the fraction of uranium X_1 , which is brought down by precipitating lead or bismuth as sulphide in a dilutely acid solution of uranium X.

If lead sulphate is precipitated in an acid solution containing uranium X, the curves obtained by measuring the activity of the precipitate are shown in fig. 2. Curve I. is the theoretical

Fig. 2.

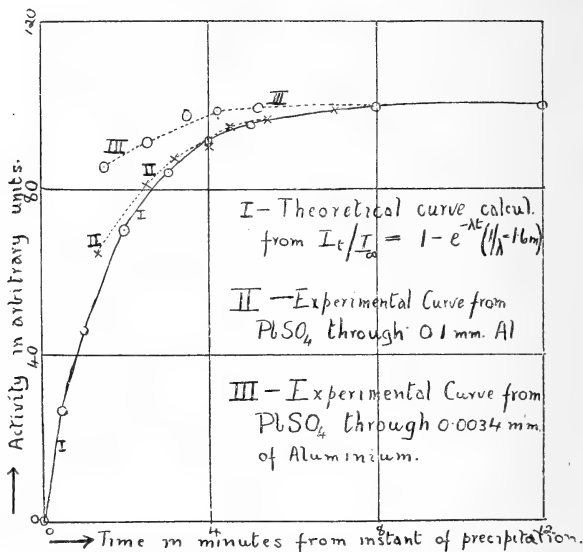

curve calculated on the assumptions that the rays of uranium X_1 , if any, do not reach the ionizing-chamber of the electroscope, and that it disintegrates directly into uranium X_2 , which does give rays penetrating into the electroscope, and which has a period of average life of 1.6 minutes. Curve II. is the curve obtained experimentally by precipitating lead sulphate in a uranium X solution and measuring the activity of the product through 0.1 mm. of aluminium, that is to say, hard β rays alone are measured. This curve is seen to be in close agreement with the theoretical curve. It is therefore concluded that the hard β rays usually associated with uranium X do not belong to the body with a half period of 24.6 days, but to the new body of half period of 1.1 minutes. Curve III. is the curve obtained by precipitating lead sulphate in the usual way and measuring the activity of the precipitate

through 0.0034 mm. thick aluminium foil. This curve does not at all coincide with the theoretical curve, and would not, if extrapolated backwards, cut the axis at the moment of precipitation near zero. This therefore shows that uranium X_1 gives non-penetrating radiations, and, as it is known to give off no α rays, these rays must be the soft (β) rays. Fajans and Göhring's conclusion that the hard β rays of uranium X come from uranium X_2 has therefore been confirmed.

When barium sulphate or thorium oxalate is precipitated in a uranium X solution, uranium X_2 seems to remain in solution in excess over uranium X_1 , but, owing to the difficulties of filtering, four to five minutes elapse between the instant of precipitation and the first measurement in the electroscope. After this lapse of time very little change can be expected in the activity of the precipitate, so that it is not possible to say definitely whether the curve extrapolated backwards would cut the axis near zero.

The substance is somewhat similar to bismuth in respect that it is soluble in acid solutions, but tends to be precipitated on addition of water. It is, however, distinct from that element in respect of solubility and of volatility. In the experiment described above, in which a complete separation of uranium X_2 was obtained, on allowing the filtrate to stand a further precipitate of bismuth oxychloride came down, showing that although the whole of the uranium X_2 had been precipitated, only a fraction of the bismuth had been removed. Uranium X_2 is therefore, under these conditions, less soluble than bismuth. A preparation of uranium X containing iron and bismuth was ground to a powder with a quantity of iodine. The powder was then placed in a tray and heated quickly to a bright red heat in the blow-pipe. A relatively cool piece of copper foil held above the tray collected volatilized bismuth iodide in appreciable quantities, but it was quite inactive. On measuring the activity of the tray immediately it became cool no disturbance of the equilibrium activity was observed. Uranium X_2 is thus shown to be less volatile than bismuth.

From the theoretical considerations referred to, uranium X should belong to the tantalum group of metals, and therefore Soddy proposed to call the substance "eka-tantalum." Tantalum itself is not a volatile substance, but the fluoride of tantalum is appreciably volatile, more so than that of niobium. So that since uranium X_2 has a higher atomic weight than tantalum one would expect that the fluoride should also be volatile. Under no circumstances, however, could the substance be volatilized. Uranium X contained

in a very small quantity of iron was dissolved in hydrofluoric acid and placed in a platinum tray. The acid was slowly evaporated off until it was nearly all gone when the tray was rapidly raised to a bright red heat in the blow-pipe. Immediately it was cool the platinum tray was taken to the electroscope and its activity measured. No change in the activity of the material in the tray could be detected in consecutive measurements taken over twenty minutes. The same constancy of activity was seen, no matter whether tantalum or thorium was present or absent. Potassium bifluoride was also tried in place of hydrofluoric acid, but no trace of any disturbance of the equilibrium conditions was observed.

The substance, since it belongs to the fifth group, should have properties resembling tantalum, and thus its most definite reactions should be concerned with the different fluorides. No facts of importance, however, could be obtained in this direction, as immediately a precipitate of any kind was formed in presence of hydrofluoric acid the uranium X_1 was carried along with it.

The chemistry of uranium X_2 thus remains extremely vague. Tantalum is generally recognized by chemists to be a very difficult substance to work with, and a body of higher atomic weight occupying a position in the same group is not likely to have more distinctive reactions. In addition to this, such reactions as tantalum possesses almost all require a few hours to take place, and such, of course, are no use for a substance of which the period of average life is 1.6 minutes. All that can be said is that it appears to resemble tantalum in the ease with which it is precipitated, but it has not been found possible to obtain a definite proof of this view.

It is of interest to consider the question of the parent of actinium. Soddy*, in his paper on the "Radio-elements and the Periodic Law," made the suggestion that if the still unknown substance which he called "eka-tantalum" had a very long life it might be the parent of actinium, as well as of uranium II. in a double change. As it turns out, however, this substance has a very short period, and consequently it cannot be the parent of actinium; otherwise the α rays necessary for the production of actinium would be easily detectable. If the actinium series is connected with the uranium series then the only other possibility seems to be that radium disintegrates in two ways, the main branch being formed by the expulsion of an α ray and giving the product radium emanation, while the lesser branch is formed

* Soddy, *loc. cit.*

by the expulsion of a β ray or by a rayless change. In the latter case the product would belong to the third group, and would be actinium itself or a product non-separable from it.

Summary.

1. The existence of a new radio-active disintegration product, uranium X_2 , discovered by Fajans and Göhring, has been confirmed.

2. Its period of average life is 1.6 minutes and its period of half-value is 1.1 minutes.

3. The hard β rays of uranium X come from uranium X_2 as found by Fajans and Göhring, and the soft (β) rays come from uranium X_1 .

4. Hence uranium X_2 cannot be the parent of actinium.

It gives me much pleasure to acknowledge my indebtedness to Mr. F. Soddy, F.R.S., for his stimulating interest and advice.

Physical Chemistry Department,
Glasgow University.
July 1913.

XLI. *On the Intrinsic Optical Rotativity of Solutions.*

By G. H. LIVENES, B.A., *Fellow of Jesus College, Cambridge*.*.

IN a recent communication to this journal a theory of the intrinsic rotational optical activity of a substance in solution was developed, and a formula obtained which appeared to provide a simple explanation of most of the complications arising in the actual experimental cases. This theory did not, however, appear sufficiently general to include all the irregularities in the actual phenomena, and further investigation seemed necessary.

As is well known, a large number of suggestions have already been made to account for the phenomena under discussion, but each of them appears to fail in certain more or less well-defined cases. I thought, however, that a reconsideration of these suggestions on the basis of the new formula might lead to a complete explanation of the apparently anomalous behaviour of active substances in solution.

The numerous complexities which the specific rotation of dissolved substances exhibit may have their origin in different processes according to the nature of the active and inactive substances. All possible processes which are involved in

* Communicated by the Author.

solutions—such, for instance, as dissociation, breaking down or formation of molecular aggregates, hydrolysis, and other not precisely known actions—may cause a variation in the optical rotative power of the solution; and, in fact, each of these actions has in turn been suggested as the cause of the variation. It is our present object to discuss the more important suggestions on these lines to see how they may be regarded as accounting for the facts. Although such a discussion leads to a probable rejection of all of these actions, as having no effect on the rotative power of the solution, certain important deductions can be drawn from the evidence advanced in support of the various hypotheses, which indicate, moreover, the lines along which future investigation must go. We consider these suggestions in turn.

1. *Electrolytic Dissociation.*—The evidence advanced in support of an effect of this kind is well and impartially analysed by Landolt in his book, and I shall here only give a summary of the arguments.

The origin of the explanation by electrolytic dissociation was the discovery that the molecular rotations of a number of neutral salts of tartaric acid in solution in water all approximated to the same value as the solutions were more and more diluted. By making similar experiments with solutions of certain active alkaloids neutralized in different acids, Oudemanns found that the rotation of the alkaloids in dilute solutions in water did not depend on the acids, and from his result he deduced his well-known rule expressing this fact. The rule was later extended to active acids on the grounds that certain acids after saturation with different bases, or in the form of dilute solutions of their salts, always have practically the same rotativity. Further experiments on the influence of the concentration on the rotation of solutions of salts of malic and other acids have shown that their molecular rotations, which are very different in concentrated solutions, agree more and more as the dilution is increased.

An explanation of these phenomena was first attempted by Hädrich on the basis of Arrhenius' theory of electrolytic dissociation. His idea was essentially that in the dilute solution the active ion, being completely dissociated from the inactive ion, would exert its influence unhampered by that ion. Apparent confirmation of the theory was provided by experiments conducted by Hädrich himself, who examined solutions of various active alkaloids neutralized with different acids. His results, in general agreement with those mentioned above, show that (i.) the molecular rotation of each salt

approaches a definite constant value as the dilution is increased, and (ii.) the different constant values are the same for any one alkaloid. These facts have been confirmed in numerous cases since Hädrich's original experiments, but, of course, substances have been found for which the rule is not true. It may, however, be said in favour of the original idea that these abnormal substances are either such as cannot be obtained in very dilute solution, or else their nature is such that other very obvious actions tend to hinder the occurrence of the ordinary regularity.

On closer investigation we find, however, that Hädrich's theory does not appear to give the true cause of the variations, because the same phenomena have been noticed in solutions where the degree of dissociation is certainly very small. For example, Walden found with α -bromocamphorsulphonic acid and some of its salts that the molecular rotations of the solutions of the free acid and the different salts all approximate to the same value as the dilution was increased, although the degree of the dissociation is very different in the different cases.

Before proceeding further we might for a moment turn to our theoretical formula to see how the specific rotation of dilute solutions should behave. We found that the specific rotation of the solution containing active substance at a partial density ρ in a solvent at a partial density σ was of the form

$$[\omega] = \frac{\lambda'(\lambda\rho + \mu\sigma)}{(1 - a\lambda\rho - a\mu\sigma)^2}.$$

We now make the probably correct assumption that the rotative power of an active atomic group is not altered when it enters a chemical molecule as a constituent part of the combining acid or base. This assumption is, of course, not new, and receives some support from other than the present phenomena. We can then write

$$\lambda\rho = \lambda_1\rho_1 + \lambda_2\rho_2,$$

where ρ_1 refers to the partial density of the active group, and ρ_2 to the density of the combined inactive base or acid. Thus

$$[\omega] = \frac{\lambda'(\lambda_1\rho_1 + \lambda_2\rho_2 + \mu\sigma)}{(1 - a\lambda_1\rho_1 - a\lambda_2\rho_2 - a\mu\sigma)^2}.$$

From this formula we see at once that as the dilution of

the solution is increased the specific rotation approximates more and more to the value

$$[\omega] = \frac{\lambda' \mu \sigma}{(1 - a \mu \sigma)^2},$$

where σ now refers to the density of the pure solvent. Such a value is quite independent of the nature of the inactive constituent of the dissolved compound.

We thus see that our theoretical formula leads directly to an explanation of all of the above-mentioned facts, without any additional hypothesis regarding the effect of dissociation on the active ion. It would thus appear that such facts cannot in any way be used to support this hypothesis. On the other hand, as similar phenomena have been observed also with undissociated substances, we may conclude that simple dissociation of the active from the inactive ion in the molecule can have no effect on the specific rotation of the solution, provided that the asymmetric group remains intact in either of the ions.

In a further attempt to distinguish the effect of electrolytic dissociation on the rotativity, Landolt and Oudemans found that by decreasing the degree of dissociation of the active substance by adding to the solution other electrolytes the rotation was altered. For example, it was found that the specific rotation of tartaric acid was altered, and in different ways, by replacing the simple water solvent by solutions of hydrochloric, sulphuric, or other acid. The explanation of their results is, however, very simple if we rewrite the above formula in a suitable way. If the water solvent is replaced by a solution containing any inactive substance at a partial density σ_2 in water at a density σ_1 , we must replace in the above formula $\mu\sigma$ by $(\mu_1\sigma_1 + \mu_2\sigma_2)$, and the specific rotation is accordingly altered to

$$[\omega] = \frac{\lambda'(\lambda\rho + \mu_1\sigma_1 + \mu_2\sigma_2)}{(1 - a\lambda\rho - a\mu_1\sigma_1 - a\mu_2\sigma_2)^2},$$

a formula which clearly indicates the effect of the altered solvent.

Numerous other experimental results of a similar nature admit of similar simple explanations based on the above formula, but it seems unnecessary to detail them all here. The formula appears sufficiently general to include the greatest majority of them, if not all. It might, however, be mentioned that Walden has found that in very dilute solutions of compounds in which the anion and cation are both active the rotation is the sum of the separate rotations of the separate ions. This is, of course, an immediate deduction from our formula.

The second hypothesis explains the variation of the specific rotativity of certain substances in solution by

2. *The formation of molecular aggregates.*—Such an explanation has, of course, been experimentally “confirmed” for certain cases, but its general explanation is not nearly so wide or even so well supported as in the previous case. A discussion similar to that given above will, however, show that this process has probably also very little to do with the modifications of the rotativity of the dissolved molecules. The few facts usually explained by an assumption of this kind are all involved in our formula.

3. *Other actions.*—Similar reasoning will also dispose of any probable effect due to other actions of a type similar to those just discussed. The experimental evidence advanced in support of these actions does not appear sufficiently conclusive to enable us to deny the actual existence of these effects; but as all the experimental results appear to be involved in the present theory without any extensions, we may conclude that their action is at least small, if not actually non-existent.

Conclusion.—The present discussion leaves the subject in a very unsatisfactory state, but the theory points the way for the future experimental investigations which may help us to more definite conclusions.

The present theory explains the effects by the variation in the velocity of transmission of the light-waves in the solution. Whether this theory contains a complete account of the phenomena is uncertain, but it can be tested. As I have before pointed out, the variation caused by the alteration in the electrodynamic conditions under which the typical electron vibrates, and which govern the velocity of transmission, is closely allied to the variation of the index of refraction of the medium, and a formula expressing the relation was given. A measurement of the refractive index in each experiment would thus enable us to determine the completeness of the present explanation.

If it is found that the variation of rotativity is not completely accounted for on this theory, then we are again driven to account for the departure from the course here theoretically discussed by assuming a definite modification in the chiral group in the molecule produced in perhaps different degrees by the different circumstances under which the molecules are examined. There is at present, however, no warrant for such an assumption, but I hope someone will take up the question and provide us with some experimental facts to argue from.

XLII. Notes on β and γ Rays. By J. A. GRAY, D.Sc.*

IN this paper, some remarks are made on two effects of scattering on ionization curves and also on the measurement of intensity of γ rays. They are given here as they have some bearing on the discussion in the next paper.

In many cases, when taking absorption curves of β , γ , and X rays it is found that the ionization produced by the rays can be approximately expressed by the relation $I = I_0 e^{-\mu x}$, where I represents the ionization and x the thickness of the absorbing material. It might appear at first sight that rays which were such that their quality was unchanged when they passed through matter would give such an ionization curve, but this is not necessarily the case as the following considerations show.

Schmidt † has worked out a theory of the absorption of β rays in which it is assumed that in passing through a layer of absorbing material of thickness dx , a beam of β rays loses a fraction αdx by absorption, βdx by scattering. If we assume the scattered rays to be of the same quality they will also be absorbed and scattered to the same extent. If R is the intensity of the rays passing through a plate of thickness x , r the intensity of the rays "reflected" from the same plate, then

$$R = \frac{1 - P^2}{1 - P^2 e^{-2\mu x}} e^{-\mu x}, \quad \dots \dots \dots (1)$$

$$r = \frac{P}{1 - P^2 e^{-2\mu x}} (1 - e^{-2\mu x}), \quad \dots \dots (2)$$

μ and P being connected with α and β by the equations

$$\alpha = \frac{\mu(1 - P)}{1 + P}, \quad \beta = \frac{2\mu P}{1 - P^2}.$$

When x is large enough,

(1) reduces to $R = (1 - P^2)e^{-\mu x}$,

the ionization curve becoming exponential, and

(2) becomes $r = P$,

so that P represents the fraction reflected from a "thick" plate.

It is only when P^2 is small compared with unity that the ionization curve is exponential.

Schmidt's equations apply approximately to the transmission of the β rays of radium E through lead. Results are given below (Table I.) of the relative readings obtained

* Communicated by Prof. H. T. Barnes, F.R.S.

† Schmidt, *Ann. d. Phys.* xxiii. p. 671 (1907).

when these rays are absorbed by lead. Lead foils were used of thickness 0.00152 cm.

TABLE I.

Ionization.	Number of foils.	Percentage transmitted by each foil.
100		
46	1	46
26.6	2	57
16.9	3	63
11.2	4	66
7.4	5	67
5.02	6	68
3.40	7	68

The scattering of the β rays is so marked in lead that it matters little whether the β rays are initially parallel or not. The numbers agree very well with the formula (1)

$$R = 100 \frac{1 - P^2}{1 - P^2 e^{-2\mu x}} e^{-\mu x},$$

where $P = 0.70$ and $e^{-0.00152\mu} = 0.68$.

The third column shows that the first foil only transmits 46 per cent. of the rays, while when the ionization becomes exponential, the same foil transmits 68 per cent. Consequently, when P is large the ionization curve $I = I_0 e^{-\mu x}$ does not signify rays (β or γ) the quality of which is unaltered by transmission through matter.

For example, Crowther * has found that when homogeneous β rays are tested by platinum the ionization curve is approximately exponential. As a "thick" layer of platinum would reflect about 70 per cent. of the β rays tested, we see that the rays cannot remain homogeneous; a fact which Crowther † had previously proved and which has been well brought out by recent experiments of W. Wilson ‡. The reason why the ionization does not decrease more quickly at first is because the decrease in ionization is almost entirely due to scattering, there being very little absorption. Scattering also accounts for the rays becoming heterogeneous after

* Crowther, Proc. Roy. Soc. A. lxxxiv. p. 226 (1910).

† Crowther, Proc. Camb. Phil. Soc. 1909.

‡ W. Wilson, Proc. Roy. Soc. A. lxxxvii. p. 310 (1912).

passing through small thicknesses of platinum. The scattering is so great that after passing through the platinum many β rays have traversed much longer paths and so have lost more energy. It is possible also that when β rays are scattered through large angles, they lose energy. In the case of small thicknesses of aluminium the chance of a β ray which has once been deflected through a large angle being again so deflected is small, so that the transmitted rays remain more homogeneous.

The theory of Schmidt only applies strictly to cases where the rays are unaltered in quality by transmission through matter. It is easily seen, however, that if the percentage of rays reflected is large there will always be a similar decrease in the first part of an ionization curve due to scattering. In the case of γ rays the percentage reflected is usually so small that this effect is not noticeable, and a greater absorption at first is in most cases correctly interpreted by saying that "softer" rays are being cut out, the rays as a whole becoming "harder."

There is, however, another way by which scattered γ rays can alter ionization curves (see fig. 1). Let A represent a

Fig. 1.



• A

source of γ rays, E a measuring electroscope 10 or 20 cm. away, and suppose we take ionization curves firstly by placing absorption plates directly above A, secondly by placing them directly under E. It has been found by several observers that lower values for the absorption coefficient are found in the first case. This is really due to the scattering of the rays. When the absorption plates are placed directly above the active material they subtend a comparatively large solid angle, and so a greater percentage of scattered rays enters

the electroscope. The readings are uniformly higher, and consequently when calculating the absorption coefficient in the usual way we get a lower value. This effect may be quite large, as very simple experiments show. It is more noticeable in the case of β rays. In a similar experiment Kovárik has shown that by placing aluminium above the active material (radium (D+E+F) in a position corresponding to A it was actually possible to increase the ionization as much as 20 per cent. After a certain thickness, however, the ionization decreased in the usual way. It is only when the rays have passed through sufficient material to nullify the two effects of scattering noted above, that we can speak of absorption according to an exponential law. In considering the first effect, it has been assumed that the absorbing plates were placed directly under the ionization chamber or electroscope.

In some experiments to be described in the following paper, the writer has occasion to compare the intensities of γ rays of different penetrating powers. It is first necessary to define intensity. A tentative definition of the intensity of a beam of γ rays is made by assuming that the number of rays excited by a beam of intensity I in passing through a layer of thickness dx is simply proportional to $\mu I dx$, where μdx is the fraction of the rays absorbed. We measure γ rays by ionization, and the ionization caused by γ rays in an ordinary electroscope is due to two causes:—

- (1) Ionization due to the absorption of γ rays in the air of the electroscope;
- (2) Ionization caused by β rays coming from the walls of the electroscope.

From the first cause the ionization will be greater, the softer the rays, as a greater percentage of them will be absorbed in the gas. The number of β rays escaping from the walls and the ionization from them depend very largely on the nature of the walls. The number will depend on (a) the absorption coefficient of the γ rays, (b) the penetrating power of the β rays excited by the γ rays.

In the experiments described later, γ rays for the most part enter and leave the electroscope by carbon. Now carbon absorbs the γ rays of radium E about three times as much as the γ rays of radium, and the X rays characteristic of silver about 10 times as much. The β rays excited by the γ rays of radium can penetrate more than a centimetre of carbon, those excited by the γ rays of radium E 0.015 cm.*, and those excited by X rays characteristic of silver about 0.00003 cm.

* A result obtained last year but not yet published.

From this we see that the absorption coefficient of the γ rays in carbon decreases at a much slower rate than the penetrating power of the β rays excited by them. Consequently, for beams of the same intensity we shall get a smaller reading for the second cause, the less penetrating the γ rays, the walls being sufficiently thick to give the maximum effect. It depends on the ratio of the ionizations due to (1) and (2) what value we get when comparing two types of radiation, but it is thought, in the cases dealt with, that the second cause gives more ionization than the first, so that the softer the beam of γ rays the less ionization they will give. As an approximation, the ionization is taken as a measure of the intensity.

McGill University,
Montreal.

XLIII. *Notices respecting New Books.*

Elementary Practical Mathematics. By Prof. JOHN PERRY, F.R.S.
Pp. xiv + 335. 6s. Macmillan & Co. Ltd. 1913.

ONE of the greatest difficulties in teaching mathematics so as to make the work interesting to the average student is that it is almost impossible to illustrate the work by examples drawn from real life. Most of the examples in text-books are of no intrinsic value and are highly artificial.

Professor Perry's book will be welcomed for its great wealth of practical examples. They are in most cases too difficult for any but advanced students, and we are still in need of elementary practical examples. Mr. David Mair has brought out two such books, mostly dealing with geometry, and I understand that Dr. Nunn is engaged in a book of a similar type dealing chiefly with arithmetic and algebra, so that in the near future we shall be fairly well supplied. What will then be needed will be that Examining bodies will aim at making at least some of their questions of the practical type, and extending or modifying their syllabus of requirements accordingly.

At the same time Prof. Perry seems to me to be too severe in his condemnation of what he calls 'academic' work. A student who is brought up entirely on practical problems will not be nearly so well equipped for tackling new work as one who has been trained on the old carefully graduated theoretic lines—his knowledge is likely to be scrappy and slipshod, though he will have learned the habit of making the most of such methods as he knows, and have discovered that many difficult problems can be made to yield to very simple methods.

It is really for the student with no special aptitude for mathematical reasoning that the stimulus of practical examples is most needed. To the more thorough student they are only useful

occasionally. To attempt nothing else would be like feeding a pupil on tonics instead of food.

The examples in the book range from arithmetic, algebra and mensuration to deflections of beams, electrical problems, and vibrations, natural and forced, finishing with a chapter on vectors. When a formula is needed he sometimes proves it, but generally not, his theory being that formulæ can be got from books and that the main need for a student is to be able to use them, and never be afraid of them. There are valuable hints on the use of squared paper, and many illustrative examples.

A student would get many practical hints from the book in any subject with which it deals, provided he had already studied some systematic treatise on the subject or had laboratory or workshop familiarity with it, otherwise he would be bewildered by the rapidity with which he is carried through whole sets of new ideas, and the masses of formulæ, mostly unproved, which bristle on page after page: most useful as summaries, but indigestible by a novice.

Professor Perry speaks slightly of Simpson's Rule, which he apparently thinks is accurate only for parabolic areas, whereas it is accurate for unicursal cubics. Certainly in cases where many sections of an irregular area can be taken, nothing could be better than the mid-ordinate rule, and it would be futile to use Simpson. But for regular curves, except those which touch the bounding ordinates, Simpson is hard to beat. Let Prof. Perry apply it with 4 ordinates to the sine curve (p. 98) instead of his 9 mid-ordinates.

There is apparently an error in Ex. 9 (p. 138) where the best speed seems to be 12 miles per hour, *i. e.* 8 miles per hour relative to the bank, not 4.5 as given in the text.

It is impossible to give in small space an account of all the subjects treated. The book itself must be obtained for this purpose. It is a regular storehouse from which teachers can draw any number of such examples as they need, and in some cases the students themselves might well work systematically through some of the chapters. The book will be welcomed with gratitude, tempered by a somewhat amused irritation at the sarcasms hurled at the heads of mathematicians on page after page.

The Collected Mathematical Papers of JAMES JOSEPH SYLVESTER.
Vol. IV. Cambridge University Press, 1912.

WITH this volume Dr. H. F. Baker completes his labours in editing Sylvester's Collected Papers, and thereby earns the gratitude of the mathematical world. It has been from first to last a serious undertaking; and although the editor fears that many errors in the printing of formulæ still remain, readers may rest assured that all that human skill can do has been done in presenting Sylvester's work in an error-free form. Fully one quarter of the present volume is taken up with the lectures on the theory of

Reciprocants, which had their start from the inaugural lecture at Oxford in 1886. Other sustained series of papers are those on the theory of Partitions, and on the theory of binary Matrices including quaternions. Dr. Baker has enriched the volume by an interesting biographical notice, the closing paragraphs of which give a brief appreciation of Sylvester's contributions to the development of mathematics. It appears that, conjoined with an extraordinary fecundity of mathematical thought and an exhilarating enthusiasm on whatever problem in analysis or geometry he was attacking at the moment, there was a curious indifference to certain great fields of mathematical research. Nevertheless his "position is secure. As the physicist glories in the interest of his contact with concrete things, so Sylvester loved to mark his progress with definite formulæ. . . . His work will endure, according to its value,—mingling with the stream fed by innumerable men,—of which the issue is as the source. He is of those to whom it is given to renew in us the sanity which is called faith."

An Introduction to the Mathematical Theory of Attraction. Vol. II.
By F. A. TARLETON, LL.D. Longmans, Green & Co.
London, 1913.

THIS book is in continuation of the first part published some fifteen years ago, and begins, in Chapter VIII., with the discussion of spherical harmonics and their application to the attraction of ellipsoids. Chapter IX. investigates the more elementary parts of magnetism, finishing with a brief account of the expression for the magnetic potential of the earth. The remaining three chapters give a serviceable presentation of Maxwell's theory of electromagnetism. The author recognizes that this is unusual in a book devoted to the theory of attractions. But that is after all merely a convention, there being as much attraction in the relations of currents and magnets as in gravitation itself. The wave surface is discussed in considerable detail, but there is no attempt to lead up to the more modern theories associated with the names of Lorentz, Hertz, and Einstein. As far as it goes, the book contains an admirable description of the electromagnetic theory of light as it left Maxwell's hands.

Revolving Vectors with special Application to Alternating Current Phenomena. By Professor G. W. PATTERSON. The Macmillan Company. New York, 1911.

THIS small book by the Professor of Electrical Engineering in the University of Michigan gives clearly and concisely the essential features of the graphical representation of complex quantities and their application to electrical problems after the manner inaugurated by Steinmetz. The author explains the real significance of the processes, leading the student from the

conception of $\sqrt{-1}$ as a rotator to the expression of the same idea by exponentials of imaginary quantities. Then follow developments regarding circular motion, damped spiral motion, and simple harmonic motion, with applications to various types of circuit, and in later chapters the phenomena of the oscillatory discharge and mutual induction of interlinked circuits. There is a little bit of criticism of Maxwell's use of the terms lines of induction and lines of force, which might mislead the reader otherwise unaware of the fact that it was pre-eminently Maxwell who brought quantitative clearness into the relations between induced electromotive force and lines of induction. The term Flux takes the place of Maxwell's lines of induction or Faraday's lines of force. Now Professor Patterson begins paragraph 60 with these words: "To show that it is flux (Faraday's lines of force) and not field strength (Maxwell's lines of force), which determines electromotive force, we may consider, etc." The author does not mean it, but the inexperienced reader might easily imagine that Maxwell regarded flux as corresponding to his lines of force. Paragraphs 59 and 60 should be rewritten so as to make quite impossible a misunderstanding on this point. Maxwell himself was perfectly clear and perfectly accurate.

Optical Geometry of Motion: a new View of the Theory of Relativity. By ALFRED A. ROBB, M.A., Ph.D. Heffer and Sons. Cambridge, 1911.

THE fundamental idea of the writer of this pamphlet is that the axioms of geometry are the formal expression of certain optical facts. The most elementary experiment of vision tells us when three points lie in one straight line. On the assumption that light travels from particle to particle in straight lines with a definite speed, Mr. Robb finds in the difference of time taken by a flash of light to pass in different directions round a triangle a criterion for absolute rotation. The system is worked out in an original and suggestive manner, and leads to an interesting comparison between Euclidean and Lobatschewskijian geometries.

Electromagnetic Radiation and the Mechanical Reactions arising from it. Being an Adams Prize Essay in the University of Cambridge. By G. A. SCHOTT, B.A., D.Sc. Cambridge University Press, 1912.

BY the addition of seven appendices Professor Schott has nearly doubled the length of the original Essay, for which the Adams Prize was awarded in 1909. Apart altogether from the value of the author's own contributions to the theory of moving electrons, the mere presentation of this rapidly growing subject in a connected form is of the utmost importance, not only to the student engaged on a first study of modern electric theory, but also to the investigator who will be able to refresh his memory on many difficult points without having recourse to the scattered memoirs of the day. It would be impossible in a short review to

give any true conception of the scope of the present work, which covers 420 quarto pages. That could best be gained by a careful perusal of the author's preface. It will suffice to say that the author starts from Maxwell's fundamental equations of the electromagnetic field, as modified by the introduction of moving electrons, deduces general expressions for the electric and magnetic forces due to the moving charges, and works out in detail a host of problems of vital importance in the present development of the theory of electric radiation. For example, the last appendix is devoted to the Lorentz electron in regard to its motion in a steady electromagnetic field with the electric and magnetic forces (1) parallel, (2) perpendicular, (3) inclined at any angle; and the final problem is that of the motion of an electron within a fixed sphere of uniform electric density.

XLIV. *Proceedings of Learned Societies.*

GEOLOGICAL SOCIETY.

[Continued from p. 380.]

June 11th, 1913.—Dr. Aubrey Strahan, F.R.S., President; and afterwards W. Whitaker, B.A., F.R.S., F.G.S., in the Chair.

THE following communication was read:—

‘On a Group of Metamorphosed Sediments situated between Machakos and Lake Magadi in British East Africa.’ By John Parkinson, M.A., F.G.S.

That part of British East Africa which borders the Athi Plains and extends westwards to the eastern edge of the Rift Valley, is undulating country composed of foliated rocks of ancient appearance, crossed by pegmatites which are unconnected with any apparent granitic intrusions.

A series of crystalline rocks, for which it is proposed to use the name Turoka Series, is situated just below the great lava-plateau of the Kapiti Plains, and forms the ground drained by the head-waters of the Turoka River. The following rock-types are present in the chief section, in the following apparent upward succession:—

- (1) Hornblende-schist, seen to a thickness of 3 feet 5 inches; (2) flaggy and impure marble, 3 feet; (3) biotite-gneiss, 2 feet; (4) calc-mica-rock with lenticles of biotite-gneiss, 3 feet 8 inches; (5) hornblende-schist similar to No. 1, 1 foot; (6) impure calc-rock, 2 feet; (7) quartz-felspar-vein, 2 feet; (8) hornblende-schist, 2 feet; and (9) impure calc-rock, resembling No. 5 and about 4 feet thick.

A detailed petrographical description is given of the various rock-types present in the series which, in addition to those mentioned above, includes kyanite-garnet-gneisses and a scapolite-garnet-rock. The author concludes that the group represents a series of metamorphosed arenaceous and calcareous sediments, and that there is a complete passage from calc-mica-rocks into biotite-gneisses.

THE
LONDON, EDINBURGH AND DUBLIN
PHILOSOPHICAL MAGAZINE
AND
JOURNAL OF SCIENCE.

[SIXTH SERIES.]

OCTOBER 1913.

XLV. *The Photoelectric Effect.*—II. By KARL T. COMPTON
and O. W. RICHARDSON, *Princeton University* *.

INTRODUCTION.

THERE are two lines of experimental investigation which have been followed in the search for the ultimate explanation of the photoelectric effect from metals. Most of the work in this subject has had to do with the *velocities* of the emitted electrons and the relation of these velocities to the nature of the emitting metal and the frequency and intensity of the incident light. Numerous experimenters have shown that the velocities of the electrons are independent of the intensity of the incident light, and are nearly, if not entirely, independent of the photoelectric fatigue, except in so far as this fatigue alters the intrinsic potential of the metal †, and therefore alters the amount of energy lost by the electrons in escaping. It has therefore been possible to investigate the relation between velocity and frequency without having to take special means of allowing for these two factors. To this extent the investigation of photoelectron velocities is free from complications which are troublesome when the number of emitted electrons instead of their velocities is being studied. This line of investigation has therefore received the most attention.

* Communicated by the Authors.

† K. T. Compton, *Phil. Mag.* vol. xxiii. p. 579 (1912).

Recent work by the writers* and by Hughes † has well established the fact that there is a linear relation between the maximum initial kinetic energy of the emitted electrons and the frequency of the incident light. This relation has been suggested before, but secondary effects due to reflected light and reflected electrons, to impurity of the spectrum, and several other factors have rendered the experimental proofs of this relation uncertain and contradictory. The relation may be expressed by the formula

$$V = k\nu - w_0,$$

where V is the maximum initial kinetic energy of the liberated electrons, expressed in equivalent volts, k and w_0 are constants, and ν is the frequency of the incident light. The average value of k for eight different metals we found to be

$$k = \frac{300}{e} 5.4 \cdot 10^{-27} \text{ erg sec.},$$

while Hughes found

$$k = \frac{300}{e} 5.6 \cdot 10^{-27} \text{ erg sec.}$$

as the average for a number of metals. w_0 is the work, expressed in equivalent volts, done by an electron in escaping from the metal. Our work showed that, within the limits of experimental error, w_0 for any metal has a value which may be calculated independently from a direct knowledge of w_0 for platinum and the contact difference of potential between platinum and the given metal.

These experimental results confirm the theory of photoelectric action which was recently developed by one of the writers ‡. By thermodynamic and statistical methods the conclusion was reached that the relation between velocity and frequency should be given by the equation §

$$V = \frac{300}{e} h\nu - w_0, \dots \dots \dots (1)$$

where h is Planck's constant, $6.55 \cdot 10^{-27}$ erg sec. The

* Phil. Mag. vol. xxiv. p. 575 (1912).

† Phil. Trans. Roy. Soc. London, A. vol. cxxii. p. 205 (1912).

‡ O. W. Richardson, Phys. Rev. vol. xxxiv. p. 119 (1912); Phil. Mag. vol. xxiii. p. 615 (1912); vol. xxiv. p. 570 (1912); Science, vol. xxxvi. p. 57 (1912). 300

§ The factor $\frac{300}{e}$ appears throughout this paper because the practical system of electrical units is employed.

theory also led to an expression connecting w_0 for two metals s and p of the form *

$${}_s w_0 - {}_p w_0 = V_p - V_s - \theta \frac{\partial}{\partial \theta} (V_s - V_p), \dots (2)$$

where $V_p - V_s$ is the contact difference of potential between the metals, expressed in volts. The term involving the absolute temperature θ expresses the Peltier effect, and may be neglected in comparison with $V_p - V_s$. The theoretical and experimental values of w_0 agree fairly well. The fact that k is considerably less than the theoretical value h is probably not due to manipulative error, but to experimental error of a more insidious nature. On the whole, however, the support of the theory is consistent and satisfactory.

The second line of attack on the photoelectric problem is the investigation of the effect of the intensity of the light, the frequency of the light, and the nature of the metal on the number of electrons emitted in unit time. Lenard † and others have shown that the number of emitted electrons is simply proportional to the intensity of the incident light. As to the influence of the nature of the metal, it is known in a general way that the more electropositive metals give larger photoelectric currents. It is also known that the slightest oxidation or other chemical action on the illuminated surface of the metal greatly decreases the size of the photoelectric currents. This "fatigue" is prevented in proportion as a perfect vacuum is approached. Except for the work of Pohl and Pringsheim, which will be discussed later, little is known concerning the relation between the frequency and the rate of emission of electrons except the fact that photoelectric currents apparently increase as shorter wave-lengths of light are employed ‡.

The theory of photoelectric action developed by one of the writers § yields an expression connecting the frequency, nature of the metal, and number of electrons emitted in unit time, as well as the expression for the initial kinetic energy already referred to. The complete theory leads to the following equations:

$$N \neq 0 \text{ when } 0 < \frac{300}{e} h\nu < w_0, \dots (3)$$

* O. W. Richardson, *Phil. Mag.* vol. xxiii, p. 264 (1912); vol. xxiii, p. 615 (1912).

† *Ann. d. Phys.* vol. viii, p. 149 (1902).

‡ Hallwachs, *Ann. d. Phys.* vol. xxx, p. 593 (1909).

§ *Op. cit.*

$$N = \frac{Ah}{R^2\nu^2} \left(1 - \frac{ew_0}{300h\nu}\right) \text{ and } V = \frac{300}{e} h\nu - w_0$$

when $w_0 < \frac{300}{e} h\nu < 0$. . . (4)

In these equations N is the number of electrons emitted per unit area per unit time by light of unit intensity, A is a constant characteristic of the metal, and R is the absolute gas constant reckoned for one molecule. The other symbols have the meanings assigned to them previously.

An examination of the expressions for N shows several facts in support of the theory. There is apparently a critical frequency, given by

$$\nu_0 = \frac{w_0}{h} \frac{e}{300}, \text{ or } \lambda_0 = \frac{300}{e} \frac{h}{w_0} c, \quad . \quad . \quad . \quad (5)$$

below which there is no photoelectric emission.

This we found to be true. The agreement on this point between theory and experiment is illustrated by Table I.,

TABLE I.

Metal.	λ_0 observed.	λ_0 calculated.
Na	577 $\mu\mu$	550 $\mu\mu$
Al.....	360	360
Mg	375	390
Zn	357	340
Su	337	305
Bi.....	337	290
Cu	309	275
Pt	280	270

which shows the values of the critical wave-lengths for eight metals. The calculated values of λ_0 are obtained from equations (5) and (2), taking w_0 for platinum to be 4.7 volts*, and using values of the contact difference of potential of each metal with respect to platinum as taken from standard tables. The observed values are a little uncertain, since the photoelectric currents are small in this region, and since we used a quartz-mercury arc, which gives a discontinuous spectrum. However, we determined λ_0 as best we could under the circumstances. Some of these values were determined during the course of this investigation. The rest are

* H. L. Cooke and O. W. Richardson, Phys. Review [2] vol. i. p. 71 (1913); Phil. Mag. vol. xxv. p. 624 (1913).

taken from our last paper. Considering the fact that the intrinsic potentials of the investigated surfaces may have been somewhat different from the values given in the tables, and since the finite size of the spectrometer-slits caused a slight overlapping in the spectrum, these results are in very fair support of the theory.

We have, therefore, good experimental support of those results of the theory expressed by

$$N=0, \text{ when } 0 < \frac{300}{e} h\nu < w_0$$

and
$$V = \frac{300}{e} h\nu - w_0, \text{ when } w_0 < \frac{300}{e} h\nu < 0.$$

There still remains to be tested the equation

$$N = \frac{Ah}{R^2\nu^2} \left(1 - \frac{e}{300} \frac{w_0}{h\nu} \right), \text{ when } w_0 < \frac{300}{e} h\nu < 0. \quad (6)$$

The purpose of this paper is the experimental investigation of the relations involved in this equation.

Preliminary Considerations.

At the outset it should be remarked that equation (6) is not necessarily the only or the complete expression of the theory. The thermodynamic and statistical treatment yielded two integral equations which were not satisfied by any analytic function continuous throughout the entire range of variation. It was found, however, that equations (3) and (4) are a solution of these integral equations. The complete solution may therefore consist of the sum of several terms, of which equation (6) is only one part. This suggestion will be considered again later in the paper. It is also possible that the approximations used lead to an error in this part of the solution.

One evident requirement of the theory is that the rate of photoelectric emission must reach a maximum at some particular frequency, instead of increasing indefinitely with the frequency as was at first supposed. For from equation (6)

$$\frac{dN}{d\nu} = \frac{Ah}{R^2\nu^3} \left(\frac{e}{300} \frac{3w_0}{h\nu} - 2 \right) = 0,$$

whence

$$\nu_{\max.} = \frac{3}{2} \frac{e}{300} \frac{w_0}{h} = \frac{3}{2} \nu_0, \quad (7)$$

and

$$\nu_{\min.} = \infty \quad (8)$$

$$\frac{d^2N}{d\nu^2} \text{ is } \begin{cases} \text{negative when } \nu = \frac{3}{2} \nu_0 \\ \text{positive when } \nu = \infty \end{cases}$$

Therefore equation (6) requires the photoelectric sensitiveness of any metal to be a maximum at a wave-length equal to $\frac{2}{3}\lambda_0$, where λ_0 is the longest wave-length at which electrons are emitted, and it requires that the sensitiveness approach zero when the wave-length is exceedingly small.

The existence of a maximum in the curve representing the relation between frequency and rate of emission is proved by the work done on a large number of metals by Pohl and Pringsheim*. The results of their experiments may be generalized in the statement that the wave-length-rate of emission curve for every metal is of the type shown in fig. 1, *abcde*, and that for each metal the starting-point and the position of the maximum are at wave-lengths peculiar to the given metal. *N* is the number of electrons emitted

Fig. 1.

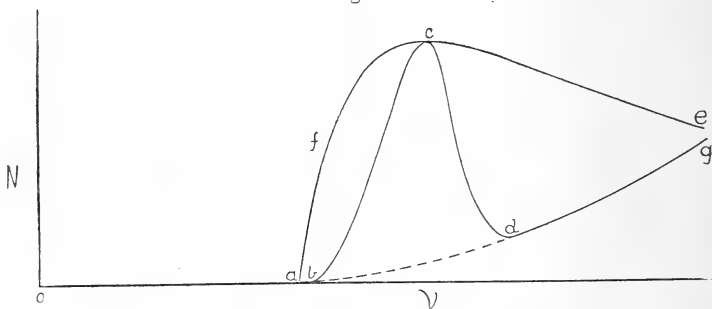

per second by a unit amount of light-energy. They find that the part *bcd* of the curve is present only when there is a component of the electric intensity in the light-wave which is perpendicular to the mirror surface of the metal. When the light is incident perpendicularly the part *bcd* degenerates into the dotted line *bd*, which forms part of a continuous curve *abd*. This curve is not in good agreement with equation (6), which is represented by the curve *afcg*. However, the theoretical curve *afcg* was obtained on the supposition that the radiation incident on the metal is isotropic, while the experimental curve of Pohl and Pringsheim was obtained with the light incident at a certain definite angle. They found that the relative importance of the "hump" *bcd* depends greatly on the angle of incidence. Therefore these curves are not strictly comparable.

However, Pohl and Pringsheim found that the position of the maximum is nearly or entirely independent of the angle

* *Verh. d. D. Phys. Ges.* vol. xiii. p. 474 (1911); vol. xii. p. 349 (1910); vol. xii. p. 682 (1910); vol. xiv. p. 46 (1912), &c.

of incidence. Therefore we may use their data on the wave-length at which the photoelectric emission is a maximum for various metals, and compare these results with the requirements of the theory expressed by equation (6), or rather, by equation (7). This comparison is shown in Table II. The calculated values of λ_{\max} are obtained from equation (7), taking w_0 for each metal as given by equation (2), taking values of the contact difference of potential with respect to platinum from standard tables, and taking for platinum $w_0=4.7$ volts. The observed values of λ_{\max} are taken directly from Pohl and Pringsheim's papers. The blank spaces represent cases in which the data are not available and are put in because they may be of interest later.

TABLE II.

Metal.	λ_{\max} . calculated.	λ_{\max} . observed.
Rb	475 $\mu\mu$
K	404 $\mu\mu$	440
Na	367	335
Ca	360
Ba	280
Li.....	...	280
Mg	260	250
Al.....	240	247.5
Zn	223	...
Sn	200	...
Cu	184	...
Pt	180	...

Wherever comparison is possible the agreement with the theory is quite good. Pohl and Pringsheim did not determine points close together on their curves, and the exact positions of the maxima are doubtful within limits large enough to account for most of the discrepancies in the table.

The most obvious discrepancy between the theoretical equation and the curves of Pohl and Pringsheim is that the sensitiveness in the region of very short wave-lengths is increasing as the wave-length decreases, while the theory requires that it should finally fall to zero. The further experimental test of the theory, as expressed by equation (6), which we shall now proceed to describe, differs from the work of Pohl and Pringsheim principally in the fact that we secure approximate isotropic monochromatic radiation falling on the strip, and that we extend the measurements farther out into the ultra-violet than has hitherto been done.

The Photoelectric Measurements.

The apparatus which we found most satisfactory for making the photoelectric measurements is illustrated in fig. 2. It is similar to that used in our previous experiments

Fig. 2.

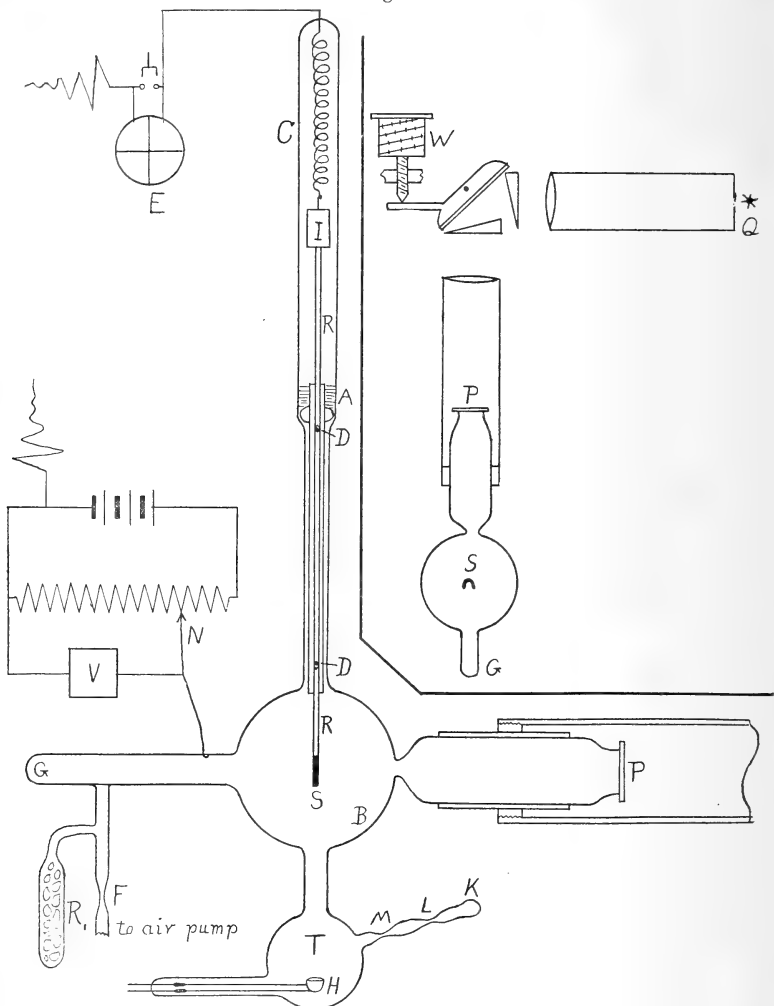

on electron velocities, with the addition of arrangements designed to make possible a more perfect vacuum and to give an absolutely clean, untarnished metal strip upon which to focus the light from the spectrometer-slit. Light from the

Heraeus quartz mercury arc-lamp Q entered the collimator-slit of a Hilger monochromatic ultra-violet illuminator and entered the photoelectric cell through a quartz window P. The apparatus was adjusted so that the light from the slit was exactly focussed on the strip S of metal to be tested, so that the strip and the image of the slit exactly coincided for each wave-length of light. The wave-length of light falling on the strip was shown directly by the graduated drum W. The degree of adjustment could be examined by looking into the bulb at G. The requisite vacuum was obtained by first using a Gaede pump, then sealing off the pump connexion at F and immersing the tube of coconut charcoal R₁ in liquid air. Under the influence of the light, electrons escaped from the strip S to the inside silvered surface of the bulb B. The rate of emission of electrons was measured by observing the rate of deflexion of the electrometer E, which was connected with the strip S. The bulb B was maintained at a positive potential of 5 volts (contact difference of potential being allowed for). This gave complete saturation and prevented any reverse current from B to S due to light reflected from the strip S to the walls of the bulb B.

It has been mentioned that the theory is based on the assumption that isotropic radiation falls upon the metal strip. Since the light falling upon the strip in our apparatus was practically a parallel beam, we secured the equivalent of the incidence of isotropic light by bending the strip around a lengthwise axis into such a shape that, with a parallel beam of light striking it, there would be the same proportion of light incident at each angle as if isotropic radiation were incident on a plane surface. We determined graphically the shape of cross-section of the strip necessary to fulfil these conditions, and found that it is approximately elliptical, with the major axis twice the minor axis, and pointing in the direction of the light.

In order to obtain absolutely fresh metal surface for the photoelectric tests we adopted the following device. The metal strip S, of elliptical cross-section and just the size of the image of the slit, was fixed to the end of a light aluminium rod R which was capable of a motion up and down in a closely fitting brass tube. Stops D were arranged so that the upper limit of motion brought the strip exactly in the path of the light, while the lower limit left the strip inside of a small bulb T directly below the main bulb B. The brass tube was firmly waxed into the outer glass tube at A. A soft iron block I was attached to the upper end of the aluminium rod, so that the strip could be moved up or down

at will by sliding an electromagnet up or down outside of the apparatus. A suspending spring C was just strong enough to keep the strip in its regular position when the electromagnet was removed. A bit of the metal to be investigated was placed in the quartz furnace H, which was wound with a platinum heating-coil. After the requisite vacuum had been obtained, the strip S was drawn into the bulb T and the metal distilled from the furnace over on to the strip, where a thin film of the metal to be investigated was deposited. Then the strip was returned to its position in the bulb B, and photoelectric measurements were made as soon as possible. This method worked very satisfactorily, and can be used for most metals which melt below about 1000° C.

This was the apparatus used in testing sodium. The low melting-point of caesium made a variation of this process more convenient. The caesium, after being washed in anhydrous ether, was placed in the small bulb K, which was at once sealed on to the tube ML. After a liquid-air vacuum had been maintained for several hours the caesium was melted so that it flowed successively through the constrictions at M and L. The caesium oxide and other impurities were left behind at L, and the tube was sealed off at M with a blowpipe. Then the caesium was distilled on to the strip by gently heating the bulb T. This method proved very satisfactory, for the caesium gave practically constant photoelectric currents during the time necessary to complete a test.

These precautions were not taken when aluminium and platinum were tested, although in the case of aluminium we should probably have obtained better results had we taken them. In these cases the metal strip was scraped with a clean knife-blade in air, quickly placed in position, and the vacuum pump started. Certainly some oxidation of the aluminium surface occurred before the vacuum was obtained.

As soon as the strip S was ready for the test the drum W was turned so as to cause light of different wave-lengths to fall successively on the strip. For each wave-length we measured the deflexion of the electrometer in some definite interval of time, say ten seconds. Thus data were obtained giving, in arbitrary units, the number of electrons liberated in unit time from the metal by the light of each wave-length represented in the spectrum of the mercury arc. But in order to apply these results to test equation (6) it was necessary first to make a correction for the fact that the various lines in the arc spectrum were not all of equal intensity. This necessitated a calibration in order to find the relative energies in different parts of the spectrum. Then, when the

number of electrons liberated per unit time by light of each wave-length was divided by the energy of the light of the corresponding wave-length, the quotient represented the relative number of electrons liberated in unit time by a unit amount of light-energy for each wave-length. These values may be used directly to test equation (6). They are called *N* in the curves and are plotted as ordinates.

The Energy Calibration.

The relative energies in different parts of the spectrum were measured by means of a bismuth-silver linear thermopile made by W. W. Coblentz*. This thermopile was adapted to the monochromatic illuminator and was placed directly back of the slit in the telescope arm. This slit was adjusted to the exact width and position of the strip which had been tested photoelectrically. The energy was determined by a compensation method illustrated in fig. 3. The thermopile

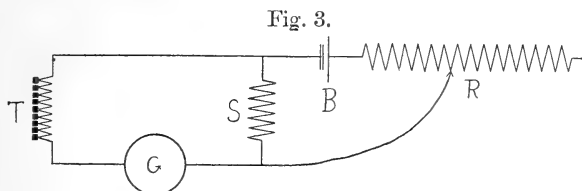

T was connected in series with a shunt *S* and a Thomson astatic galvanometer *G*. A second circuit contained, in series, the shunt *S*, a battery *B*, and a variable resistance *R*. The battery was connected so that its electromotive force opposed that generated by the thermopile. The resistance *R* was adjusted so that no current flowed through the galvanometer. Under these conditions the radiation energy falling on the thermopile was inversely proportional to the resistance *R*. For the current through the battery is

$$I = \frac{E}{R + b + \left(\frac{1}{\frac{1}{s} + \frac{1}{t + g}} \right)},$$

where *E* is the electromotive force of the battery, and *b*, *s*, *t*, and *g* are the resistances of the battery, shunt, thermopile, and galvanometer respectively. *R* varied from 20,000 to 1,200,000 ohms in different parts of the spectrum, *b* and *s* were each 0.01 ohm, *t* was 8 ohms and *g* was 10.5 ohms.

* Franklin Inst. Journ. clxxv. p. 151 (1913).

Therefore we may neglect all of the resistance except R, and write

$$I = \frac{E}{R}.$$

The drop across S was

$$d = I_s = \frac{E_s}{R} = \frac{K}{R},$$

where K is a constant. When the resistance R was adjusted so that no current passed through the galvanometer, obviously

$$\frac{K}{R} = e,$$

where e is the electromotive force generated by the thermopile. Thus the electromotive force was inversely proportional to the resistance R. But the electromotive force is proportional to the rise in temperature, which in turn is proportional to the energy of the incident light. Therefore the reciprocal of the resistance required for compensation was a measure of the energy of the light incident on the strip.

By this method the galvanometer was a detector only, and the measurements were independent of any changes in its sensitiveness. For measurements in the extreme ultra-violet between wave-lengths $200 \mu\mu$ and $250 \mu\mu$ the sensitiveness of the galvanometer was about 5×10^{-11} ampere per division. In the rest of the spectrum it was unnecessary to maintain such high sensitiveness.

The calibration of the spectrum was repeated at intervals during the course of the investigation. It was found that, for a given number of amperes running through the arc-lamp, the energy distribution in the spectrum remained practically constant during the period of the three months' investigation. The slight variations that occurred were allowed for.

There is one peculiarity of the apparatus which should be mentioned before taking up the experimental results. The collimator slit, the metal strip, and the slit in front of the thermopile were each $\frac{1}{16}$ inch wide. This large width resulted in considerable overlapping and impurity in the visible part of the spectrum from wave-lengths $400 \mu\mu$ to $700 \mu\mu$. But out in the ultra-violet the dispersive power of the instrument was about twenty times as great as in the visible spectrum, so that in this region, which was the most important, the error due to the finite sizes of the slits was negligible. The reason for making the slits so wide was that in the visible spectrum the photoelectric currents were

small and in the ultra-violet the energy was small, so that in both parts of the spectrum it was found best to use fairly wide slits and strips. The effect of this width of slits will be considered when the experimental results are discussed.

Experimental Results.

Platinum.—The experimental results in the case of platinum are given in Table III. λ and ν are the wave-length and frequency of the incident light, d_1 and d_2 are deflexions of the electrometer per half minute, d is the average of d_1 and d_2 , E is the energy of the incident light in arbitrary units, and N is proportional to the number of electrons emitted per unit time by light of unit intensity. The readings were taken in order down the column d_1 and then up the column d_2 . The averages should be relatively independent of any fatigue

TABLE III. *Platinum.*

λ .	ν .	d_1 .	d_2 .	d .	E .	$N = \frac{d}{E}$.
200 $\mu\mu$	150(10) ¹³	34	32	33	1.00	33
202	148.5	31	29	30	1.00	30
204	147	23	24	23.5	0.83	27
214	140	44	40	42	1.7	25
220	136	58	51	54.5	2.0	27
230	130	71	62	66.5	4.1	16
240	125	55	50	52.5	6.3	8.3
254	118	34	31	32.5	24.3	1.5
260	115.5	16	14	15	22.7	0.7
270	111	5	5	5	16.6	0.3
280	107	1	4	2.5	14.5	0.2
290	103.5	0	1	0.5	21.2	0.02
300	100	0	0	0	43.5	0

Fig. 4.

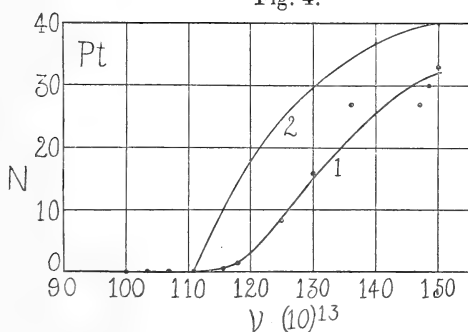

effect. The relation between λ , ν , and N is shown graphically in fig. 4, curve 1. Curve 2 is the graph of equation (6), the ordinates being in arbitrary units.

Aluminium.—Table IV. contains the results of the first set of measurements with aluminium. The absolute values

TABLE IV. *Aluminium.*

λ .	ν .	d_1 .	d_2 .	d .	E.	$N = \frac{d}{E}$.
200 $\mu\mu$	150 (10) ¹³	103	87	95	1.11	85
202	148.5	90	76	82	0.91	90
204	147	85	70	78	0.83	94
208	144	99	92	96	0.91	105
212	141.5	149	130	140	1.25	112
214	140	172	150	161	1.43	113
220	136	249	223	236	2.00	118
224	133.7	319	294	306	2.80	113
226	132.5	343	322	333	2.95	113
228	131.5	363	343	353	3.45	102
230	130	401	385	393	4.20	93
232	129.2	423	406	415	4.75	87
234	128.2	439	430	435	5.30	82
236	127.1	500	481	490	5.90	83
240	125	500	493	497	7.1	70
242	124	531	518	525	7.7	68
254	118	1300	1200	1250	28.5	44
265	113.2	518	512	515	18.5	28
275	109	294	287	290	14.5	20
290	103.5	141	140	140	21.2	6.5
313	95.5	82	78	80	55.5	1.5
339	88.5	17	17	17	29.5	0.6
366	82	7	7	7	77.5	0.09

Fig. 5.

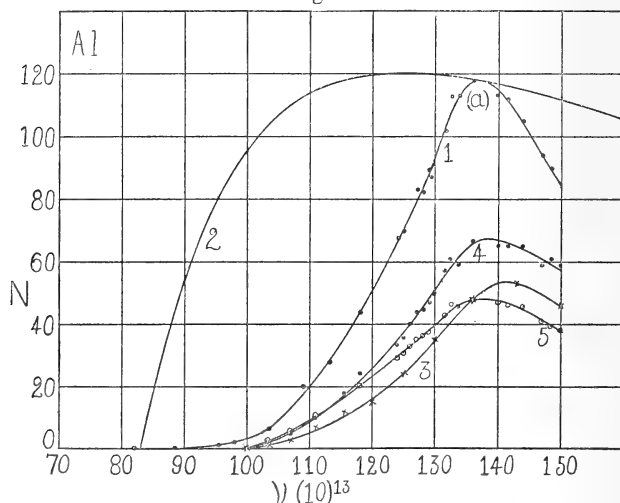

of N for the different metals cannot be compared with each other, since the experimental conditions were usually altered between each test. The curve is shown in fig. 5

(curve 1). Curve 2 is the graph of equation (6), reckoned for aluminium, N being expressed in arbitrary units. The readings for curve 3 were taken 72 hours after those for curve 1. The shrinkage represents the photoelectric fatigue during this interval. Curves 4 and 5 were taken under the same conditions as curve 1, except that the strip S was bent so as to receive the light at perpendicular and acute incidence in the two cases. Apparently the angle of incidence was of little or no influence. It must be remembered, however, that the aluminium strip was scraped with a knife-blade and was far from having a polished plane surface. Therefore this test may indicate little except that there can be no error in curve 1 due to any slight departure of the shape of the strip from its supposed elliptical cross-section.

Sodium.—The results in the case of sodium are shown in fig. 6, curves 1, 2, 3. Experimental difficulties prevented

Fig. 6.

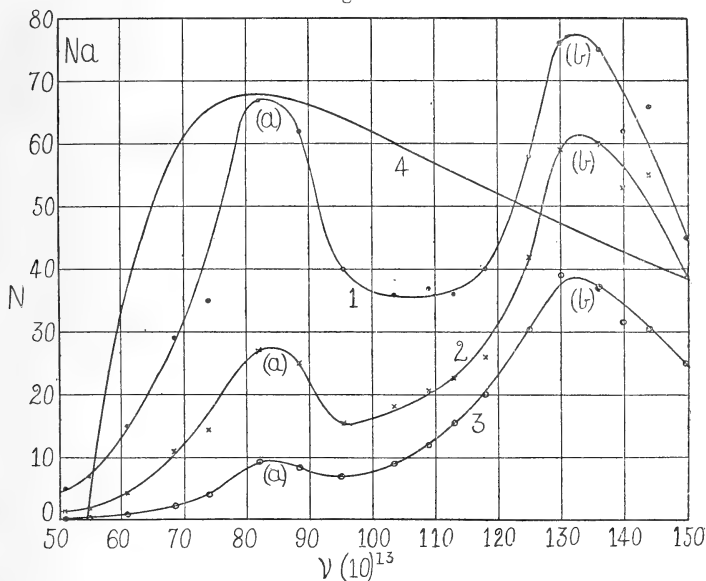

the photoelectric measurements being taken within less than one hour after the sodium had been distilled on to the strip S . Curves 1, 2, and 3 represent the variation of N with ν , 1, $2\frac{1}{2}$, and 18 hours respectively after distillation. Curve 4 represents (6) plotted for sodium, the ordinates being in arbitrary units. The photoelectric currents were about fifty times as large as in the case of aluminium. The experimental results were of exactly the same type as those shown in Tables III. and IV.

Cæsium.—The results in the case of cæsium are illustrated by fig. 7, curve 1. The energy calibration in this case was less satisfactory than in the preceding cases, since the galvanometer was rather unsteady. On the other hand, the photoelectric measurements were exceedingly satisfactory.

Fig. 7.

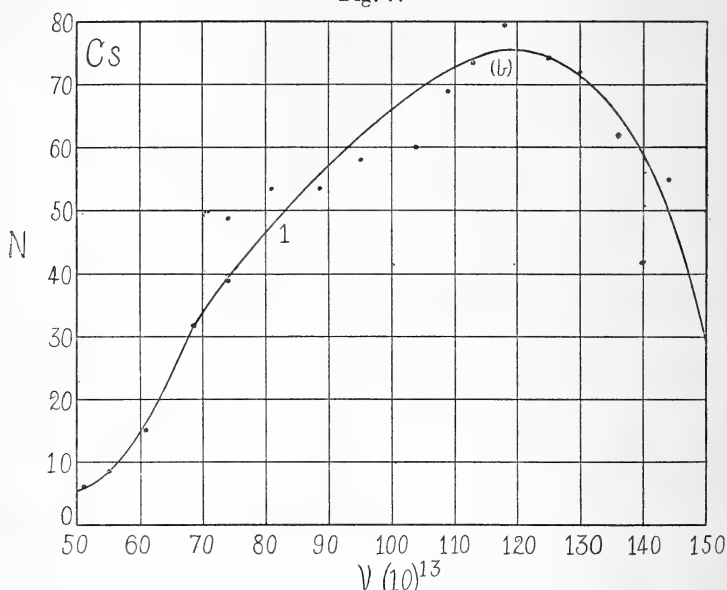

Evidently the method employed in purifying and distilling the cæsium made possible a better vacuum, and consequently there was less fatigue than in the preceding cases.

Discussion of Results.

The most striking conclusion to be drawn from these results is that there are *two* maxima in the sensitiveness-frequency curve, instead of but one maximum, as indicated by the theory and by the experiments of Pohl and Pringsheim. In the Pohl and Pringsheim curve in fig. 1 we see that the "normal" photoelectric effect, represented by *abcd*, reaches a maximum similar to that reached by the "selective" effect *bcd*, but farther out in the ultra-violet. Experiments with Röntgen rays indicate that the "normal" effect does not increase indefinitely with the frequency. The fact that we were able to discover this second maximum was due to the use of very electropositive metals and to the sensitiveness of our energy calibration system, which enabled the investigation to be carried further into the ultra-violet than ever before.

An examination of the curves for sodium shows that the first maximum (*a*) decreases more rapidly as "fatigue" proceeds than does the second maximum (*b*). This is what we should expect, since the electrons liberated by light in the region of the second maximum possess much greater initial velocities, and are therefore better able to penetrate the surface layer of oxide. Evidently, if measurements could have been made immediately after the sodium had been distilled, the sensitiveness at (*a*) would have been considerably greater than at (*b*).

In the case of platinum, fig. 4, both maxima lie beyond the region in which measurements are possible. The value of λ_0 , about $280 \mu\mu$, agrees well with the value $270 \mu\mu$ calculated theoretically.

In fig. 5 for aluminium the first maximum only appears. It is at a wave-length $\lambda_{\max.} = 220 \mu\mu$, whereas the theory would put it at $240 \mu\mu$. A possible explanation of this discrepancy is suggested by the fact that the maximum shifts to the right as photoelectric fatigue proceeds, as is seen by comparing curves 1 and 3. This is consistent with the fact, mentioned previously, that metal surfaces become more electronegative and assume properties of more electronegative metals as fatigue takes place. Since the aluminium was in contact with the air for a short while before making the test, it is certain that the true maximum for aluminium is at a wave-length longer than $220 \mu\mu$. Whether the entire discrepancy may be explained in this way is not known. The value of λ_0 , $360 \mu\mu$, agrees exactly with that calculated from the theory.

The fatigue in the case of sodium, fig. 5, was less than in the case of aluminium, because much greater pains were taken to secure a good vacuum. There is no certain evidence of any shift of the maxima with time. The first maximum (*a*) is at wave-length $360 \mu\mu$, which agrees almost exactly with the theory. The second maximum (*b*) is at wave-length $227 \mu\mu$. Because of the wide slit and strip, and consequent overlapping in the visible spectrum, λ_0 cannot be accurately determined from these curves, and it appears larger than it really is. It is probably not far from the calculated value $\lambda_0 = 550 \mu\mu$. The large overlapping in this spectral region is shown in fig. 8 (p. 566), which represents the dispersive power of the instrument at different wave-lengths. There is very little overlapping of spectral lines for wave-lengths less than $300 \mu\mu$. But the overlapping is very considerable in the visible spectrum.

The most serious effect of this overlapping appears in the case of caesium, fig. 7. Here there is little or no evidence of the first maximum, which theory and analogy would place in the red or infra-red part of the spectrum. It is possible

Fig. 8.

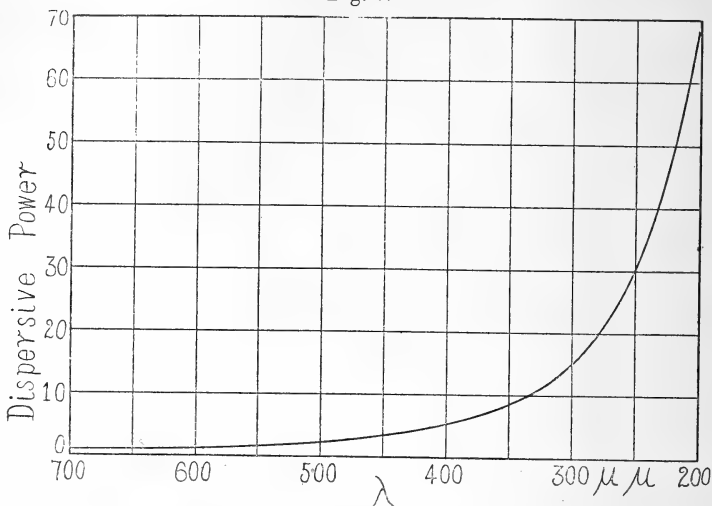

that the maximum lies beyond the range of the illuminator and the mercury arc. If it should lie at a wave-length longer than about 550 $\mu\mu$ it is also possible that it would be masked by the low dispersive power of the instrument in this region. Thus the left end of the curve is unsatisfactory. The second maximum (*b*), however, is shown very distinctly and is at a wave-length of about 250 $\mu\mu$.

Conclusion.

The experimental results indicate that the photoelectric sensitiveness is the same function of the frequency for all metals, the difference being that the curve is shifted bodily out to the region of short wave-lengths for the electronegative metals. This function is evidently not that expressed by equation (6). Equation (6), however, accurately predicts the values of λ_0 and λ_{\max} , and seems to be at least a part of the truth.

It will be remembered that earlier in the paper reference was made to the fact that equation (6) is only one solution of the theoretical equations, and that it is probably not the only or the complete solution. The results of this investigation point

to the existence of another term in the solution. If this is true, the real expression of the theory should not be equation (6), but an equation in which N equals the sum of two terms. The first term would be the right member of equation (6), or something very similar to it, and would provide the first maximum and account for the "selective" effect. The second term would provide the second maximum and account for the "normal" effect. The discovery of the equation of the relation between frequency and sensitiveness would be of practical as well as theoretical importance, since it would render possible the use of photoelectric cells as the most sensitive of spectrophotometers. We have not succeeded as yet in discovering such a solution of the theoretical equations.

We are glad to take this opportunity to express our thanks to Professor Augustus Trowbridge for many valuable suggestions with regard to the adjustment and use of the galvanometer.

Palmer Physical Laboratory,
Princeton, N.J.

XLVI. *The Effect of Ionization of Air on Electrical Oscillations and its bearing on Long-Distance Wireless Telegraphy.*
By EDWIN H. BARTON, D.Sc., F.R.S.E., Professor of Experimental Physics, and WALTER B. KILBY, B.Sc., "1851 Exhibition" Research Bursar, University College, Nottingham*.

[Plate XI.]

IN his stimulating address before the physical and engineering sections of the British Association at Dundee on Sept. 6, 1912, Dr. Fleming dealt with the various unsolved problems of long-distance wireless telegraphy.

One of the points of outstanding difficulty then commented upon was the mechanism of the propagation of the æther radiation round the curvature of the earth in those cases where about a quarter of its circumference is passed over.

In the subsequent discussion Dr. Eccles brought forward his theory †, which attributes the bending of the waves round the earth to a higher velocity of propagation in the upper regions of the atmosphere, owing to the ionization there present. This increased speed of propagation was

* Communicated by the Authors.

† Proc. Roy. Soc. A. vol. lxxxvii. pp. 79-99 (1912).

mathematically shown to follow from the conductivity produced by the state of ionization which is believed to exist in those parts of the atmosphere under consideration.

Other speakers showed that this curvature of the path of radiation could not be attributed to diffraction and spoke highly of the theory propounded by Dr. Eccles.

But although this theory seemed so preeminently satisfactory, it appeared desirable to obtain, if possible, some experimental evidence along the same lines. Indeed, Prof. Fleming expressed to one of us his wish for experimental research as to the effects of ionization on the dielectric constant and on the conductivity. Dr. Eccles similarly expressed his interest in any experimental evidence as to the effect of ionization on the velocity of electric waves.

Other kindred topics also suggested themselves as needing investigation, and various methods of attacking them were considered. It seemed however preferable, at the outset, to examine the relation between the *ionization* of the air and its *conductivity* for the alternating currents occurring in oscillations whose frequency is of the order used in wireless telegraphy. For obviously, if the increased conductivity to such alternations proved detectable, it would favour the theory of increased speed of propagation of which this conductivity is an integral part.

It appeared to us that the change of conductivity due to ionization might be inferred from the change of frequency of a circuit as detected by the Fleming cymometer or some appropriate modification of it. On trying the method, the need for unusual sensitiveness was soon apparent. This was attained by modifications of the capacity and inductance in the responding circuit, and by the substitution of a special electrometer as a quantitative detector of best resonance instead of the neon tube. Frequencies of the order two million per second were used, the wave-lengths being about 150 metres.

A full and rigorous mathematical theory of the phenomena occurring in the primary and responding circuits as used, if developed, might prove intractable or too complicated for real usefulness in the absence of precise knowledge as to the values of the constants involved. But early in the course of the work a simple theory was derived for the discharge of a leaky condenser through an inductive resistance. And it is hoped that this represents with sufficient approximation the salient features of the case. This elementary theory shows that the growth from zero of a leak in the condenser at first increases the frequency natural to the circuit. With

further increasing values of the leak, this increase of frequency of the circuit reaches a maximum, falls off to zero, and then changes sign.

Some part of the mathematical results was anticipated by general considerations, and other steps may easily be taken after the suggestion is supplied. Thus, it is easy to see that, when the condenser is being discharged by the current in the metallic circuit, the leakage current will assist this discharge and so tend to diminish the period and increase the frequency. But, when the condenser is being charged, the leak retards the process and, so far as this goes, tends to increase the period and diminish the frequency. Hence, the preponderance of the one effect or the other may fitly be expected to depend upon the relation between the leakance and the constants involved, some critical value of the leakance giving no change in the frequency.

The experiments carried out so far support this theoretical conclusion, that varying ionizations (produced by X-rays or radium) may either *increase or decrease* the frequency of the circuit in question according as the leakance produced is small or large.

The observed changes in apparent capacity were of the order one in a thousand for frequencies of about two million per second. The work accordingly yields some experimental support to the theory of Dr. Eccles as to the propagation of electric waves round the curvature of the earth owing to the ionization of the upper atmosphere.

Theory of Discharge of Leaky Condenser.

Consider the circuit shown in fig. 1, in which the condenser of capacity S is, at time t , charged by the quantity of

Fig. 1.—Leaky Condenser Circuit.

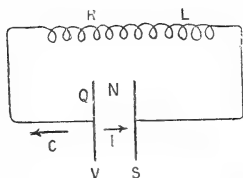

electricity Q to a potential difference V and, at that instant, yields a current C through the metallic resistance R of inductance L and, at the same instant, suffers the leakage current I through the dielectric whose *leakance* (or leakage conductance) is N , its inductance being negligible.

By consideration of the metallic circuit we have

$$V = \frac{Q}{S} = RC + L \frac{dC}{dt} \dots \dots \dots (1)$$

The dielectric current is given by

$$I = NV = \frac{NQ}{S}.$$

But the rate of decrease of Q is the sum of the two currents, that is

$$-\frac{dQ}{dt} = C + I,$$

or

$$C = -\frac{dQ}{dt} - \frac{NQ}{S} \dots \dots \dots (2)$$

Differentiating this, we obtain

$$\frac{dC}{dt} = -\frac{d^2Q}{dt^2} - \frac{N}{S} \cdot \frac{dQ}{dt} \dots \dots \dots (3)$$

Thus, substituting from (2) and (3) in (1), we find

$$\frac{d^2Q}{dt^2} + \left(\frac{R}{L} + \frac{N}{S}\right) \frac{dQ}{dt} + \left(\frac{1+RN}{S}\right) Q = 0 \dots \dots (4)$$

The solution of this may be written

$$Q = e^{-\kappa t} (A \sin qt + B \cos qt) \dots \dots \dots (5)$$

where

$$\left. \begin{aligned} 2\kappa &= \frac{R}{L} + \frac{N}{S}, \\ q^2 &= \frac{1+RN}{LS} - \frac{1}{4} \left(\frac{R}{L} + \frac{N}{S}\right)^2, \end{aligned} \right\}; \dots \dots (6)$$

and A, B are arbitrary constants depending on the initial conditions.

Let us denote by q_0 the value of q for $N=0$. Then we may write

$$q^2 - q_0^2 = \frac{N}{2S} \left(\frac{R}{L} - \frac{N}{2S}\right), \dots \dots \dots (7)$$

or, plotting the relation as a graph, we have the parabola

$$y = x(a-x) \dots \dots \dots (7a)$$

shown in fig. 2.

Fig. 2.—Variation of Frequency with Leakance.

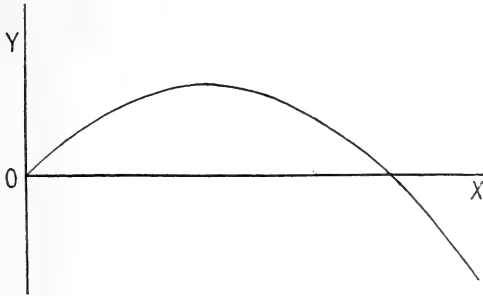

Thus y has the maximum value $a^2/4$ for $x=a/2$,

i. e.,
$$\left. \begin{array}{l} q^2 - q_0^2 \text{ has the maximum value } R^2/4L^2 \\ \text{for } N/S = R/L \end{array} \right\} \dots \dots (8)$$

(N.B.—This is analogous to the relation $K/S = R/L$ for Oliver Heaviside's distortionless telephone circuit.)

Again,

$$y = 0 \text{ for } x = a ;$$

or

$$q = q_0 \text{ for } N/2S = R/L. \dots \dots (9)$$

For values of the leakance exceeding this, q is less than q_0 and decreases continuously with increase of N , as shown in the graph.

Initial Experiments.—In the primary circuit of a Fleming cymometer a spark-gap of 3 mm. was used, and the usual rectangle of wire had a second turn added, an air-condenser being used for the capacity. The latter consisted of two polished tin plates, 30.4 cm. in diameter and placed 1 cm. apart. Parallel to the above circuit and at a clear distance of 35 cm. was the responding circuit of the Fleming cymometer (see fig. 3, p. 572). The long helix serving as a self-inductance was disconnected and replaced by a straight wire (0.5 cm. diameter) of equal length. With the apparatus in this more sensitive form a good neon tube was used as detector. The air between the plates of the condenser was

ionized either by X-rays, by the radiation from 5 mg. of radium bromide, or by both these agencies together.

Fig. 3.—Diagram illustrating Initial Experiments.

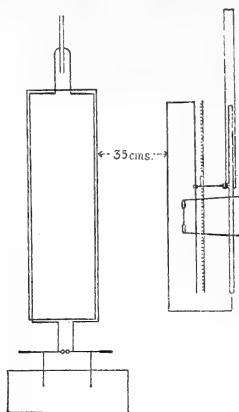

The method was to take readings alternately for the air ionized and un-ionized, the exact positions on the scale where the tube just commenced and also just failed to glow being in each case observed.

Another plan was to use a leyden-jar as the capacity in the primary circuit, and to place a multiple-plate air-condenser in parallel with the cylindrical capacity of the responding circuit, and to observe the change needed in the induction and in the latter capacity to compensate for that in the former when the air between the plates was ionized. A large number of readings showed that the fractional change, if any, in the capacity was very small. Moreover, as with the straight wire inductance in use the neon tube glowed over a length of at least 15 cm., it appeared desirable to use some still more sensitive device.

Final Arrangement.—The method described below, and shown in fig. 4, was thereupon devised, and it was along these lines that the work proceeded. The primary circuit was that of the Fleming cymometer in its original form, having a spark-gap G of 2 mm. at one end and a leyden-jar J (quart size) at the other. The circuit had a frequency of 1.93×10^6 per second. At a clear distance of 10 cm. from the primary circuit was placed the responding circuit, having a straight wire AB of 0.5 cm. diameter soldered on at one end in place of the usual helix. Connected to the terminals of the variable cylindrical condenser of the cymometer, and

thus in parallel with the same, was a special zinc-plate air-condenser ZZ.

Fig. 4.—Final Arrangement.

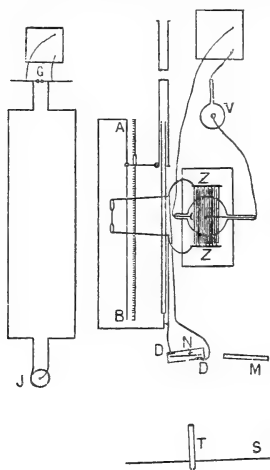

This consists of two sets of plates—one of eight, the other of seven, each plate being 30.4 cm. diameter and 0.2 cm. thick. The inner surfaces of the plates in each set were 1.2 cm. apart, leaving air-spaces of 0.5 cm. between the plates when in mesh. The plates were separated by wooden distance-pieces. Good connexion is ensured by pieces of tinfoil and a metal rod by which the plates are held securely. By sliding the plates of one set between those of the other a condenser of variable capacity could be formed. Throughout the work the maximum capacity was used; the plates were placed on clean, dry blocks of wax, and two bridges of wax were put across them to afford greater rigidity.

As a more sensitive detector than the usual neon tube a special electrometer was then used. This was of the form used by J. R. von Geitler and by one of the present writers when working under Hertz in Bonn. The needle is of aluminium and carries a small plane mirror for reading the deflexions, and a tiny magnetic needle for control. In the horizontal section shown in fig. 4, N is the aluminium needle in a vertical plane suspended by a quartz fibre; D D are two metal disks equal in size to the circular ends of the needle and attached to the inside of the wooden case. On to the projecting rods from these disks were soldered the wires from the condenser terminals. The needle is controlled by a magnet M, and the deflexions observed by means

of a telescope T and a metre-scale S. The needle is charged by *induction only*, and therefore deflects in the *same direction whatever the sign* of the potential difference under examination. The readings taken are those of the first throws, which are sensibly proportional to the time-integral of the square of the potential difference of the disks.

Now the capacity of the zinc-plate condenser is of the order fifteen times that of the portion of the cymometer in use. Consequently, if we maintain constant the frequency of the primary oscillations which force the responding circuit, then for the best response a given fractional *decrease* in the capacity of the zinc-plate condenser will involve a fractional *increase* in the cymometer capacity of nearly *fifteen* times this amount. In making observations the region where resonance occurs on the cymometer was first determined by means of a hydrogen tube. This was then removed and electrometer throws were taken at half-centimetre steps over a range of 2 cm. The main peak of the resonance curve comes well within these limits, and is found to be of considerable sharpness. Further, readings were taken in the reverse direction, and from the two resonance curves thus

Fig. 5.—Resonance Peak from Two Curves.

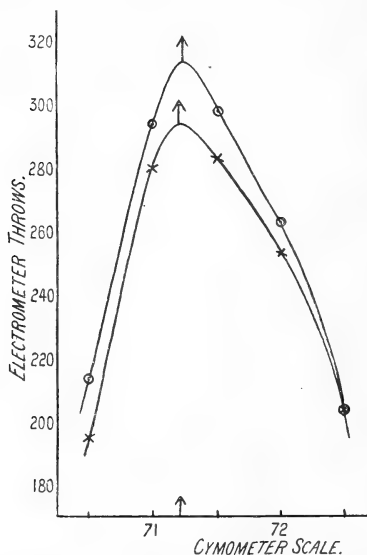

obtained the position for best response is determined correct to 1 mm. or less. A specimen of the two curves which determine a single resonance peak is shown in fig. 5. A

similar set of readings was then taken when the air between the plates of the condenser was ionized. The curves showing the shift of the peak for one case are given in fig. 6.

Fig. 6.—Shift of Resonance Peak due to Ionization.

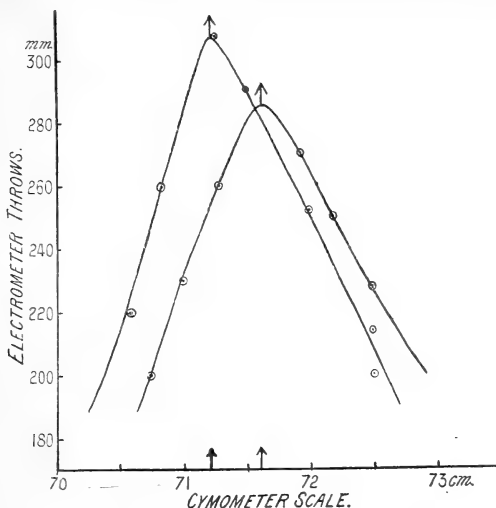

The two induction-coils used were each placed on end (see figs. 4, p. 573, and 7, Pl. XI.), as it was observed that in the ordinary position their magnetic fields affected the magnetically controlled electrometer-needle. To shield the zinc-plate condenser from the effects due to the field across the X-ray tube, an earth-connected lead plate was placed below the bulb and at a height of 22 cm. above the zinc plates. The lead screen had in the middle an opening 10 cm. square, on which could be placed piles of aluminium plates of varying thicknesses. The 5 mg. of radium bromide, when used for ionization, was placed about 5 cm. above the level of the lead screen. Moreover, to guard against dust and air-currents, the wooden framework supporting the earthed plate was enclosed on three sides with cardboard, one portion of which was removed when taking the photograph reproduced in fig. 7 (Pl. XI.). A Lodge valve V (fig. 4) was used in connexion with the X-ray tube to assist in ensuring that the discharge was unidirectional.

Results.

The results given in the accompanying table show in each case the shift of the resonance peak necessary to compensate for the change in frequency of the responding circuit when

Table showing Shifts of Cynometer Readings for Various Ionizations.

Thickness of Plates in mm. {	SHIFT OF RESONANCE PEAK IN MM.												REF. No.				
	0	.57	1.28	2.56	3.84	5.12	6.40	7.68	0.13	0.26	0.39	0.52		0.65	0.78	1.04	
IONIZATION BY X-RAYS.			+38	-1.3	+0.8	0.0	-0.9										I.
		+2.6	+0.9	-3.7		-.24											II.
		+0.6	-1.0			-3.5											III.
								-1.0									IV.
									-0.2	-0.6	-2.1	-1.4	+1.2		-1.0	-2.3	V.
									+3.9	-4.6	-2.2	-3.1	+0.3				VI.
									+2.3	-0.1	+0.2						VII.
									+1.1	-0.2	+1.9						VIII.
IONIZATION by 5 mgrms. of RADIUM BROMIDE.	+4.0		-0.2	+0.2	+0.4	+0.5		+2.1									IX.
	+3.0		-0.4	0.0	+0.2	-0.8	+0.5		+0.9	-2.3	+0.9						XI.

Fig. 8.—Variation of Frequency with Ionization.

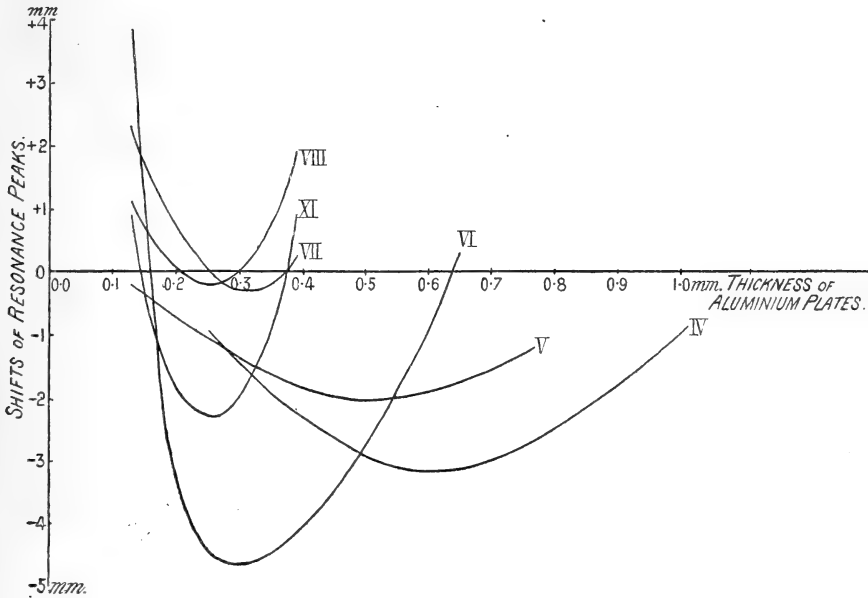
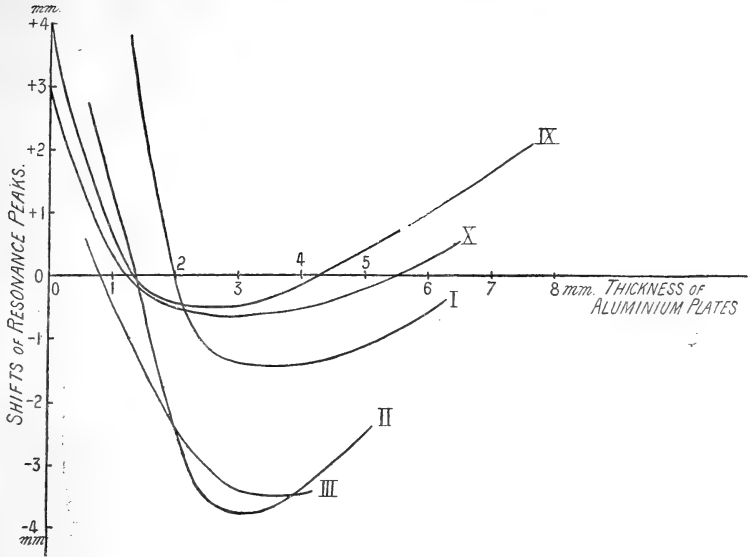

Fig. 9.—Variation of Frequency with Ionization.

the air in the zinc-plate condenser was ionized. A displacement of one centimetre of the cylindrical condenser of the cymometer corresponds to a change of 4.54 E.S. c.g.s. units in the capacity of the zinc-plate condenser which, in its normal state, had a capacity of 2099 E.S. c.g.s. units. This shift of one centimetre accordingly compensates a fractional change of 0.0022 in *apparent capacity* or in the *square of the frequency* of the circuit.

The experimental results are also plotted as graphs in figs. 8 and 9, in which the thicknesses of plates penetrated by the ionizing agents are the abscissæ and the compensating shifts on the cymometer are the ordinates.

In comparing the theoretically derived curve shown in fig. 2 with the experimental graphs, these latter should be rotated in their own plane through 180° . Their ordinates have then the correct algebraic signs for this comparison, and the greater ionizations (obtained by penetration through thinner plates) are to the right also. But absolute agreement cannot be expected, for in the theoretical curve the leakances are *proportional* to the abscissæ, and this cannot be asserted of the experimental graphs, even when in the rotated position.

Roman numerals are inserted in the right-hand column of the table. Each such numeral serves to identify the series of observations given on that line. Each graph is based on the observations occupying a single line, and, in the figure, the graph bears the numeral by which the observations are characterized in the table.

It may be noted that the results given in the table are based on nearly nine hundred electrometer throws.

The curves show that the separate observations in each series were fairly consistent but that the ionizations differed from one series to another, so that the separate curves occur in different positions.

Further, the curves follow the general form theoretically derived, but several show positive ordinates for the thickest plates instead of very small negative ones as theory would indicate. It appears that, from some unknown cause, these experimental curves are shifted up somewhat from the position theoretically deduced. But considering the smallness of the effect to be measured, the agreement is perhaps as close as could be expected.

University College, Nottingham,
July 5, 1913.

XLVII. *Corpuscular Radiation.* By H. BATEMAN, M.A.,
*Ph.D., Teaching and Research Scholar, Johns Hopkins
 University* *.

§ 1. **I**N the mathematical theory of electromagnetism it is customary to adopt the hypothesis that an electromagnetic field which occurs in nature can be obtained by superposing a number of elementary electromagnetic fields, each of which has a simple real point singularity moving through the æther with a velocity less than that of light. The solution of Maxwell's equations which corresponds to this elementary type of field has been given by Liénard † and Wiechert ‡; it is found that a constant (positive or negative) charge is associated with the singularity, and on this account the elementary field is sometimes regarded as a model of that due to a moving electron: better results, however, have been obtained by regarding the electron as an aggregate of such point charges distributed throughout a small volume.

It is implicitly assumed that electromagnetic fields with other types of singularities are non-existent. This hypothesis, however, is of such a sweeping nature that it ought only to be adopted after a careful study of the different types of singularities which solutions of Maxwell's equations can possess. After examining a few of these I have come across one type of electromagnetic field which may perhaps be of some physical interest as its chief characteristic is a corpuscular type of radiation. The brief description which has been given elsewhere § will now be amplified by a geometrical construction for the electric and magnetic vectors at an arbitrary point of space.

§ 2. The primary singularity may be described as a double-barreled gun G which moves through the æther in an arbitrary manner and keeps up a perpetual fire of secondary singularities (bullets) \parallel which move with the speed of light along straight lines in the direction of the barrels of the gun. These directions vary with the velocity of G in such a way that the angle between them is always bisected by the direction of G 's motion and its magnitude depends on

* Communicated by the Author.

† *L'éclairage électrique*, pp. 5, 53, 106 (1898).

‡ *Archives néerlandaises* (2) v. p. 54 (1900).

§ *The Annals of Mathematics*, Dec. 1913.

\parallel As far as I can make out there is no total charge associated with either the gun or the bullets.

the velocity of G , which is supposed to be less than the velocity of light (fig. 1).

Fig. 1

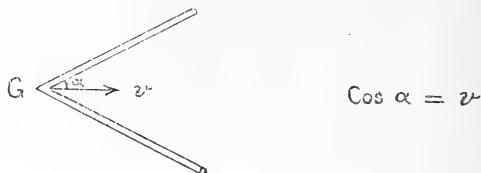

The electric and magnetic vectors at an arbitrary point (x, y, z, t) can be calculated from the state of motion of the gun at one particular time τ (depending on x, y, z, t), the corresponding position of the gun may be called the effective position for the point (x, y, z, t) . When the barrels of the gun do not alter their direction the electric and magnetic vectors vanish; hence the electromagnetic field only comes into existence when the directions of the barrels change.

§ 3. Let the motion of the gun be represented by the equations

$$x = \xi(\tau), \quad y = \eta(\tau), \quad z = \zeta(\tau),$$

where

$$\xi'^2(\tau) + \eta'^2(\tau) + \zeta'^2(\tau) < 1.$$

For each point (x, y, z, t) in space there is then just one value of τ for which

$$[x - \xi(\tau)]^2 + [y - \eta(\tau)]^2 + [z - \zeta(\tau)]^2 = [t - \tau]^2, \quad t \geq \tau.$$

(The unit of time is chosen so that the velocity of light is represented by unity.)

Now let functions $l(\tau), m(\tau), n(\tau)$ be chosen so that

$$l^2 + m^2 + n^2 = 1,$$

$$l\xi' + m\eta' + n\zeta' = 1,$$

then if

$$w = l(x - \xi) + m(y - \eta) + n(z - \zeta) - (t - \tau),$$

it is easy to verify that when $f(\tau)$ is an arbitrary function,

$$\Omega = \frac{f(\tau)}{w}$$

is a solution of the wave equation

$$\frac{\partial^2 \Omega}{\partial x^2} + \frac{\partial^2 \Omega}{\partial y^2} + \frac{\partial^2 \Omega}{\partial z^2} = \frac{\partial^2 \Omega}{\partial t^2}.$$

The functions l, m, n are always complex quantities, but we may obtain a real set of solutions of Maxwell's equations

$$\text{curl } \mathbf{E} = -\frac{\partial \mathbf{H}}{\partial t}, \quad \text{curl } \mathbf{H} = \frac{\partial \mathbf{E}}{\partial t},$$

by writing

$$\mathbf{E}_x = -\frac{\partial A_x}{\partial t} - \frac{\partial \Phi}{\partial x}, \quad \mathbf{H}_x = \frac{\partial A_z}{\partial y} - \frac{\partial A_y}{\partial z}$$

where the potentials A_x, A_y, A_z, Φ are defined by the equations

$$A_x = \mathbf{R} \frac{l}{w}, \quad A_y = \mathbf{R} \frac{m}{w}, \quad A_z = \mathbf{R} \frac{n}{w}, \quad \Phi = \mathbf{R} \frac{1}{w};$$

the symbol \mathbf{R} being used to denote the real part of the quantity following it. These four potentials are solutions of the wave equation and satisfy the relation

$$\frac{\partial A_x}{\partial x} + \frac{\partial A_y}{\partial y} + \frac{\partial A_z}{\partial z} + \frac{\partial \Phi}{\partial t} = 0.$$

The components of the electric and magnetic vectors are found to be

$$\mathbf{E}_x = \mathbf{R} \left\{ -\frac{\partial \tau}{\partial t} \left(\frac{l'}{w} - \mathbf{K} \frac{l}{w^2} \right) + \mathbf{K} \frac{\partial \tau}{\partial x} \cdot \frac{1}{w^2} \right\},$$

.....

$$\mathbf{H}_x = \mathbf{R} \left\{ \frac{\partial \tau}{\partial y} \left(\frac{n'}{w} - \mathbf{K} \frac{n}{w^2} \right) - \frac{\partial \tau}{\partial z} \left(\frac{m'}{w} - \mathbf{K} \frac{m}{w^2} \right) \right\},$$

where

$$\mathbf{K} = l'(x - \xi) + m'(y - \eta) + n'(z - \zeta).$$

We easily see that

$$\frac{\partial \tau}{\partial x} \mathbf{E}_x + \frac{\partial \tau}{\partial y} \mathbf{E}_y + \frac{\partial \tau}{\partial z} \mathbf{E}_z = 0,$$

$$\frac{\partial \tau}{\partial x} \mathbf{H}_x + \frac{\partial \tau}{\partial y} \mathbf{H}_y + \frac{\partial \tau}{\partial z} \mathbf{H}_z = 0,$$

$$x - \xi = \mathbf{M} \frac{\partial \tau}{\partial x}, \quad y - \eta = \mathbf{M} \frac{\partial \tau}{\partial y}, \quad z - \zeta = \mathbf{M} \frac{\partial \tau}{\partial z}, \quad t - \tau = -\mathbf{M} \frac{\partial \tau}{\partial t},$$

where

$$\mathbf{M} = \xi'(x - \xi) + \eta'(y - \eta) + \zeta'(z - \zeta) - (t - \tau);$$

hence it follows that Poynting's vector at any point is along the radius from the effective position of the gun. The directions of the electric and magnetic vectors are the same for all space time points which correspond to a given effective

position of the gun and lie on a radius through this position. The magnitudes of the vectors, however, vary inversely as the distance from the gun, and so the energy per unit volume obeys the inverse-square law as far as points on the same radius are concerned. It may be verified after some laborious algebra that the electric and magnetic vectors are equal in magnitude and at right angles to one another*.

§ 4. To obtain more convenient expressions for the components of the electric and magnetic vectors, we write

$$x - \xi = \alpha(t - \tau), \quad y - \eta = \beta(t - \tau), \quad z - \zeta = \gamma(t - \tau),$$

and regard α, β, γ as constants. We may then write

$$E_x = R \frac{1}{M} \frac{d}{d\tau} \frac{l - \alpha}{l\alpha + m\beta + n\gamma - 1}$$

$$H_x = R \frac{1}{M} \frac{d}{d\tau} \frac{n\beta - m\gamma}{l\alpha + m\beta + n\gamma - 1}.$$

Now let $(\lambda, \mu, \nu), (\lambda_0, \mu_0, \nu_0)$ be the direction-cosines of the barrels of the gun at time τ . We then have

$$l\lambda + m\mu + n\nu = 1, \quad l\lambda_0 + m\mu_0 + n\nu_0 = 1,$$

$$E_x = \frac{1}{2M} \frac{d}{d\tau} \left[\frac{\lambda - \alpha}{\lambda\alpha + \mu\beta + \nu\gamma - 1} + \frac{\lambda_0 - \alpha}{\lambda_0\alpha + \mu_0\beta + \nu_0\gamma - 1} \right]$$

$$H_x = \frac{1}{2M} \frac{d}{d\tau} \left[\frac{\nu\beta - m\gamma}{\lambda\alpha + \mu\beta + \nu\gamma - 1} + \frac{\nu_0\beta - \mu_0\gamma}{\lambda_0\alpha + \mu_0\beta + \nu_0\gamma - 1} \right].$$

To prove this we take the plane containing the two barrels of the gun at time τ as the plane $y=0$ and the tangent to G's path as axis of x . Then

$$\xi' = v, \quad \eta' = 0, \quad \zeta' = 0, \quad l = \frac{1}{v}, \quad m = i\sqrt{\left(\frac{1}{v^2} - 1\right)}, \quad n = 0;$$

$$\lambda = v, \quad \mu = 0, \quad \nu = \sqrt{1 - v^2};$$

$$\lambda_0 = v, \quad \mu_0 = 0, \quad \nu_0 = -\sqrt{1 - v^2};$$

$$\begin{aligned} 2R \frac{l - \alpha}{l\alpha + m\beta + n\gamma - 1} &= \frac{1 - v\alpha}{\alpha - v + i\beta\sqrt{1 - v^2}} + \frac{1 - v\alpha}{\alpha - v - i\beta\sqrt{1 - v^2}} \\ &= \frac{v - \alpha}{v\alpha - 1 + \gamma\sqrt{1 - v^2}} + \frac{v - \alpha}{v\alpha - 1 - \gamma\sqrt{1 - v^2}} \\ &= \frac{\lambda - \alpha}{\lambda\alpha + \mu\beta + \nu\gamma - 1} + \frac{\lambda_0 - \alpha}{\lambda_0\alpha + \mu_0\beta + \nu_0\gamma - 1}. \end{aligned}$$

The other identities can be established in the same way.

* A geometrical proof of this result is given below.

§ 5. Now let Q, A, A_0 be points on a unit sphere whose coordinates are $(\alpha, \beta, \gamma), (\lambda, \mu, \nu), (\lambda_0, \mu_0, \nu_0)$ respectively. Let Π be the tangent plane at the point T diametrically opposite to Q and let QA, QA_0 meet Π in the points B, B_0 respectively. Let C be the middle point of BB_0 , then if Γ denote the vector CQ we have

$$E = \frac{1}{2M} \frac{d\Gamma}{d\tau}.$$

The changes in the positions of A and A_0 in time $d\tau$ must now be marked on the sphere and $d\Gamma$ is then represented by the change in the position of C (fig. 2).

Fig. 2.

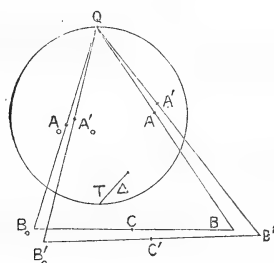

Again, if Δ represents a vector in the plane Π at right angles to TC and equal in magnitude to TC , we have

$$H = \frac{1}{2M} \frac{d\Delta}{d\tau}.$$

If $d\Delta$ is rotated through a right angle in a suitable direction, it is also represented in magnitude and direction by the displacement of C . This result proves at once that E and H are perpendicular and equal in magnitude.

Since the factor $\frac{1}{2M}$ is always negative, the directions of the electric and magnetic vectors are indicated at once by our geometrical construction. It is evident that they are both perpendicular to the radius from the effective position of the gun.

§ 6. This last fact makes it possible for us to draw lines of electric and magnetic force on a sphere whose centre is G . It will be sufficient to take this as our unit sphere, for the lines of force on a larger sphere may be obtained by a simple magnification round G .

It should first of all be noticed that the line QC meets the polar line of AA_0 with regard to the sphere, for if QC meets the sphere again in R, the four points Q R A A_0 form an harmonic set on the circle Q R A A_0 .

If now we regard A and A_0 as fixed, the correspondence between Q and R gives a conformal transformation of the sphere into itself, and the transformation is of such a nature that when we project stereographically on a plane from a fixed point V on the sphere and use the complex variable z to denote the position of a point in the plane, the affixes q, r, a, a_0 of the projections of Q, R, A, A_0 are connected by a relation of the form *

$$qr - \frac{1}{2}(q+r)(a+a_0) + aa_0 = 0.$$

Again, if A_0', A', C' denote the displaced positions of A_0, A, C and QC' meets the sphere again in S, the affixes of the stereographic projections of Q, A_0', A', S are connected by the relation

$$qs - \frac{1}{2}(q+s)(a'+a_0') + a'a_0' = 0.$$

Now the electric vector at Q lies in the plane QCC' and so is in the direction of the tangent at Q to the circle QRS on the sphere. Using the same letters to denote the stereographic projections of the points Q, R, S, A, A_0 &c., we find that the stereographic projections of the lines of electric force are such that the line through Q is tangent to the circle QRS. Let $q+dq$ denote the complex affix of a consecutive point on the line through Q, then, since the cross ratio of the affixes of four concyclic points is real, the cross ratio of $q, q+dq, r, s$ is real:

$$\therefore dq \left[\frac{1}{q-r} - \frac{1}{q-s} \right] \text{ is real,}$$

$$i. e., \quad dq \left[\frac{q - \frac{1}{2}(a+a_0)}{(q-a)(q-a_0)} - \frac{q - \frac{1}{2}(a'+a_0')}{(q-a')(q-a_0')} \right] \text{ is real.}$$

Hence, if

$$\log \frac{(q-a)(q-a_0)}{(q-a')(q-a_0')} = \phi + i\psi,$$

the curves $\psi = \text{constant}$ are the projections of the electric lines of force, and it follows that the curves $\phi = \text{constant}$ are the projections of the magnetic lines of force. The curves

* This is an immediate consequence of the result given on p. 33 of Harkness and Morley's 'Introduction to the Theory of Analytic Functions' (London, 1898).

$\phi = \text{constant}$, $\psi = \text{constant}$ are evidently the level curves and stream-lines due to the two doublets AA' , A_0A_0' , where the flow takes place in two dimensions.

To find the points on the sphere for which the electric and magnetic vectors are zero we must find when R and S coincide. The line QR is then a common tractor of two pairs of polar lines*.

Putting $r = s$, we have two equations,

$$qr - \frac{1}{2}(q+r)(a+a_0) + aa_0 = 0,$$

$$qr - \frac{1}{2}(q+r)(a'+a_0') + a'a_0' = 0,$$

which determine the values of q and r corresponding to the two real points cut out on the sphere by one of the tractors of the two pairs of polar lines. The other tractor is the polar line of the first with regard to the sphere and does not (generally) meet the sphere in real points.

Hence there are two real points on the sphere at which the electric and magnetic forces vanish. There are also two points at which the forces are infinite, viz. the points A and A_0 in which the sphere is pierced by bullets.

It should be noticed that we have proved incidentally that two pairs of real polar lines with regard to a sphere always have two real tractors.

§ 7. Let us now consider the reflexion of an electromagnetic disturbance of the type we have been studying when the mirror is an infinite plane and a perfect reflector. Let $x=0$ be the plane of the mirror, then we can satisfy the boundary condition at its surface by subtracting from the original electromagnetic field another one of a similar type in which the motion of the gun is given by the equations

$$x = -\xi(\sigma), \quad y = \eta(\sigma), \quad z = \zeta(\sigma),$$

and the direction-cosines of its barrels are $-\lambda(\sigma)$, $\mu(\sigma)$, $\nu(\sigma)$; $-\lambda_0(\sigma)$, $\mu_0(\sigma)$, $\nu_0(\sigma)$ respectively.

When (x, y, z, t) is on the mirror, $x=0$ and $\sigma=\tau$; the values of E_y , E_z , H_x are the same in both fields, and so when we subtract, the resultant electric force is normal to the mirror and the magnetic force tangential.

If this theory is correct the bullets strike the mirror and rebound in such a way that the angle of incidence is equal to the angle of reflexion, *i. e.* they are reflected like rays of light.

* *I. e.*, a straight line which meets all four. The term is due to Cayley.

XLVIII. *The Range of the Recoil Atoms from Thorium C and Actinium C.* By A. B. WOOD, M.Sc.*

IT is well known that when an α -particle is expelled from a radioactive atom the remainder of the atom recoils with the same momentum as the ejected α -particle. The penetrating power of the recoil radiation in the case of the products of radium has been studied in detail by Makower and Russ † and by Wertenstein. In the present paper the ranges of the recoil atoms from actinium C and thorium C have been investigated with the object of throwing light on the arrangement of the products in these series.

Wertenstein ‡ determined the approximate range of recoil by reducing the pressure in the recoil-chamber and thus increasing the path of the recoiling atoms. The recoiling particles were collected on a metal plate which was kept at a fixed distance from the radioactive source, and the activity of the deposit on the plate, for various pressures within the chamber, was measured. In later experiments § he shows that, on account of its large mass and high velocity, a recoil atom in its path through a gas produces an extremely intense ionization compared with the ionization produced by an α -particle over the same length of path. He describes methods of determining the range of the recoiling atom by making use of this intense ionization which it produces over its range.

The methods finally adopted in the present determination of the ranges of recoil from thorium C and actinium C are similar to these in principle, but the apparatus was designed to give, as far as possible, a homogeneous beam of recoiling atoms.

I. FIRST METHOD.

Experiments by Makower & Russ ¶ and Makower & Evans ¶¶ have shown that the recoil atoms are positively charged and consequently are attracted to the cathode in an electric field. In the preliminary experiments of the present research, experiments were made to determine the strength of the electric field and the best time of exposure to obtain a maximum of recoil product.

* Communicated by Prof. E. Rutherford, F.R.S.

† Phil. Mag. xix. p. 100 (Jan. 1910).

‡ *Le Radium*, p. 288 (Oct. 1910), and *Comptes Rendus*, cl. p. 932 (1910).

§ *Le Radium*, p. 6 (Jan. 1912).

¶ Phil. Mag. xx. p. 875 (1910).

¶¶ Phil. Mag. xx. p. 882 (1910).

For the determination of the range of recoil the arrangement shown in fig. 1 was employed. The source of active

Fig. 1.

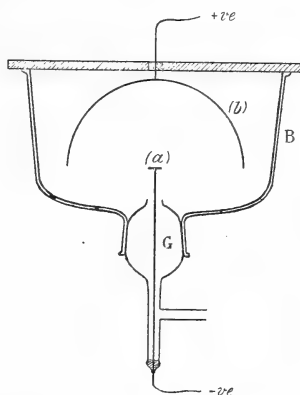

deposit (a) was adjusted at the centre of an inverted brass hemispherical bowl *b*, the whole being placed in a bell-jar *B*. The active source, introduced through a ground-glass joint *G*, was of highly polished platinum and was connected to the negative pole of a battery. When the active deposit disintegrates the recoiling atoms are projected towards the hemisphere *b*. Since they carry a positive charge and the hemisphere is also positively charged, those recoil atoms which have insufficient momentum to reach *b* will be pulled back to the active plate *a*, which is charged to a negative potential. In the experiments described here the electric field between the plate *a* and the hemisphere *b* was insufficient to decrease appreciably the range of the recoil atoms.

The product fired on the hemisphere was received on a piece of tinfoil which fitted closely over the inner surface of *b*. The activity was measured by a sensitive β -ray electroscope, a new tinfoil being used for each exposure. If the recoil atoms have a definite range, it was expected that the amount of activity received by the hemisphere *b* would remain sensibly constant below a certain "critical" pressure, but that when this pressure was reached this activity would suddenly fall to zero.

(a) *Recoil from Thorium Active Deposit.*

In the earlier experiments the results obtained were extremely inconsistent—some experiments would appear to support the view that there was only one "critical pressure,"

others to prove the existence of two, while again others indicated no definite critical pressure at all. It thus became necessary to find out the causes of these inconsistencies. One source of trouble was traced to the presence of water-vapour in the apparatus. The water-vapour, when suspended in the air, might possibly condense to some extent on the active deposit and on the recoiling atoms, and thus alter the conditions of recoil considerably. Again, it was discovered that the amount of dust admitted into the apparatus had also a striking effect on the activity received by the hemisphere. This has also been observed by Mr. Walmsley* in some experiments with actinium emanation and active deposit. With a view to finding the cause of this, we performed a few simple experiments together, and succeeded in showing that ordinary atmospheric dust in the laboratory carried a negative charge. Hence any recoiling atoms which deposit on a charged dust-particle will be carried to the positive electrode. In order to avoid these troubles all gas admitted into the apparatus was carefully dried over P_2O_5 and filtered through tightly-packed cotton-wool.

In performing an experiment, the source *a* was placed in position and a tinfoil hemisphere exposed to it for 15 minutes at the desired pressure. Air which had been previously dried and filtered was then admitted into the apparatus and the β -ray activity of the hemisphere was measured. The observed activities were corrected (1) for the decay of the source *a* (period 10.6 hours) during the experiment, and (2) for the decay of the thorium D (period 3.1 mins.) on the hemisphere during the time of its removal from the bell-jar and the measurement of its activity.

The results of a typical set of measurements with the recoil from thorium active deposit in air are shown in fig. 2. It will be seen at once that the recoiling beam is not homogeneous, as one would have expected from the experimental arrangement. No "critical pressure" is observed; the activity at first falls off rapidly with increase of pressure and afterwards less rapidly, eventually becoming nearly constant with further increase of pressure. The activities observed at pressures above 4 mm. are in all probability due to the diffusion of uncharged recoil atoms to the hemisphere. It is well known that the positively charged recoil atoms recombine with negative ions and become neutral. Since there was a comparatively intense ionization in the vessel, a small portion of the recoil atoms would lose their charge. These would diffuse to the boundaries and be unaffected by

* Phil. Mag. Sept. 1913.

the magnitude or direction of the field. It is of course possible to suppose that some of the recoil atoms acquire a negative charge in travelling through the gas, and would thus collect on the positive electrode. The possibility of the reversal of the charge on the recoil atoms due to dust is supported by some experiments of Mr. Walmsley * in this laboratory. No definite evidence, however, in support of such a view was obtained by the author.

This diffusion effect makes it difficult to determine the exact pressure at which the recoiling atoms just fail to reach the hemisphere; but by continuing the main portion of the curve to cut the pressure-axis (as shown by the dotted line in fig. 2), a fairly consistent result is obtained. The mean

Fig. 2.

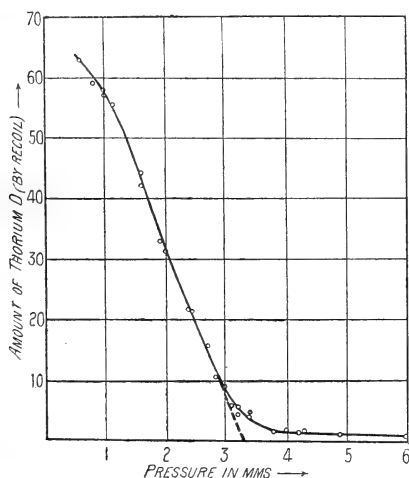

value of this pressure for all experiments is 3.25 mm. Now the internal radius of the hemisphere in the above experiments was 28 mm., consequently the range of recoil of thorium D in air at atmospheric pressure is 0.12 mm.

A number of experiments were also made in hydrogen, the curves being similar to those obtained for air. In this case, however, it was found that the range was a little over four times the range in air.

(b) Recoil from Actinium C.

On account of the relatively rapid decay of actinium active deposit, it was necessary to perform many experiments to determine a single curve showing the relation between the

* *Loc. cit.*

amount of recoil product received and the pressure in the apparatus. Hence in each experiment the activity of the hemisphere was measured after a 15 minutes' exposure at a certain "standard" pressure. It was then measured at any other required pressure.

As in the case of thorium, corrections were made for the decay of the active deposit (period 36.3 mins.) and for the decay of actinium D (period 4.7 mins.) on the hemisphere during its removal from the apparatus and measurement of its activity. All the results were standardized by reducing activities at the standard pressure to the same value, and other activities in a corresponding proportion. The curves obtained in this way are strikingly similar to those obtained in the case of thorium. A rapid fall in activity with increase of pressure is observed, the pressure at which the main curve (produced) cuts the pressure axis being 3.15 mm., corresponding to a range of recoil of nearly 0.12 mm., *i. e.*, practically the same as that of thorium D.

Now the range of the α -particle emitted by actinium C is 5.4 cm.; consequently, if we assume that the range of the recoiling atom is roughly proportional to the range of the α -particle—as Wertenstein's* results seem to show—it would at once appear that thorium D recoils from the atom emitting an α -particle of range 4.8 cm., namely thorium C₂, using the nomenclature adopted by Marsden and Darwin †. This result agrees with the deductions of these experimenters in their work on 'The Transformations of the Active Deposit of Thorium.'

If, on the other hand, thorium D recoiled from thorium C₂, which emits α -particles of 8.6 cm. range, one would have expected a considerable difference between the ranges of recoil of thorium D and actinium D, but no such difference was observed.

It has been pointed out above that the experimental curves indicated that the recoiling beam was apparently not homogeneous. Many experiments were made to discover the cause of this non-homogeneity, but with doubtful success. It is obvious, of course, that the condition of the surface of the platinum plate has a great influence, but even with plates highly polished with rouge the same effect was observed. It seems feasible to suppose that the effect is due either to the intermingling of the active deposit molecules with those of the platinum surface on which they are deposited, or possibly to the marked scattering of the recoil atoms in their passage through the gas.

* *Comptes Rendus*, clv. p. 475 (Aug. 1912).

† *Proc. Roy. Soc. A*, vol. lxxxvii. (1912).

II. SECOND METHOD—*Ionization by Recoil.*

Wertenstein* has shown clearly that recoiling atoms produce an intense ionization over their path. He adopted this property of the recoil atoms as a method of determining the range of recoil of radium D from radium C, his experimental arrangement being similar in principle to that of Bragg for determining the range of the α -particles. In this way a value of about 0.15 mm. was obtained for the range in air at atmospheric pressure. Recently he has shown † that the range of atoms recoiling from polonium is about 0.09 mm. Thus he concludes that the ranges of the recoiling atoms are roughly proportional to the ranges of the α -particles emitted by the parent products.

Fig. 3.

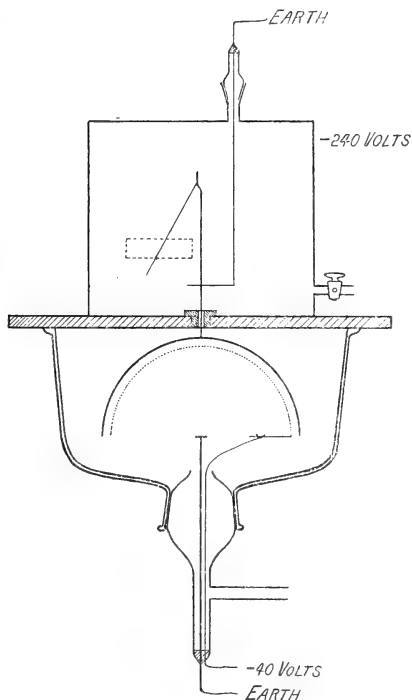

In the experiments described in this paper, the apparatus employed was a modification of that used above (see fig. 1). The arrangement is shown in fig. 3. A hemispherical ionization chamber is formed by means of two concentric

* *Loc. cit.*

† Bianu and Wertenstein, *Comptes Rendus*, Aug. 1912.

hemispheres, the inner one of fine-mesh copper gauze, insulated from each other by means of three sulphur beads. The upper brass hemisphere is insulated from and connected through the glass plate to the leaf of a sensitive electroscope which is made perfectly airtight. As before, the active deposit was obtained on a small polished platinum plate (about 3 mm. diam.) placed at the centre of the hemispheres. This apparatus was so arranged that the electroscope case, brass hemisphere, gauze hemisphere, and platinum plate could be raised to different potentials as required. In the earlier experiments a P.D. of 240 volts across an ionization chamber of depth 1 mm. was employed. At low pressures the production of ions by collision, consequent on this strong field, made the interpretation of results rather complex, hence it became necessary to work with a small P.D., about 40 volts, between the hemispheres about 3 mm. apart. In the final arrangement the case of the electroscope was connected to the negative electrode of a battery of 240 volts, the brass hemisphere and leaf being earthed. The induced charge of 240 volts on the leaf caused it to diverge at a sensitive angle. The gauze hemisphere was connected to the negative electrode of a battery of 40 volts and the active plate *a* was earthed. This arrangement proved quite satisfactory, and ionization by collision was reduced to a minimum. In connexion with this apparatus two taps were arranged so that dry gas, air or hydrogen, could be admitted in very small amounts. Thus it was possible to increase the pressure from a minimum value by small steps to any desired pressure—the ionization being measured over a considerable range of pressures and a curve connecting pressure and ionization obtained. In all experiments the upper chamber containing the leaf of the electroscope was evacuated to reduce to a minimum the ionization produced by γ rays penetrating the glass plate.

(a) *Recoil from Thorium Active Deposit in Air.*

Fig. 4, curve A, shows the result of an experiment in air. A distinct "hump" is observed at low pressures; this gradually merges into a straight line which, when produced, passes through the origin. The curve shown in the figure bears a strong resemblance to those obtained by Wertenstein for the recoil of radium B, but in this case the hump is more pronounced. It will be noticed that the maximum of the hump occurs at a pressure of about 2 mm., and the linear portion of the curve begins at a pressure of about 5 mm. These pressures for air were practically the same in all

experiments. Again, it was found that at low pressures (say 0.1 mm.) there was still a considerable amount of ionization produced, and it seemed as if the initial portion of the curve, when produced towards the axis of ordinates, did not pass through the origin. Consequently experiments were made with the active plate covered with aluminium foil to stop recoiling atoms, and it was found that the variation with pressure of the ionization by the α -particles was not linear until a pressure of about 4 mm. had been reached. The dotted curve (fig. 4 A) shows the result of an experiment of this nature. It will be seen that the curve cuts the axis

Fig. 4.

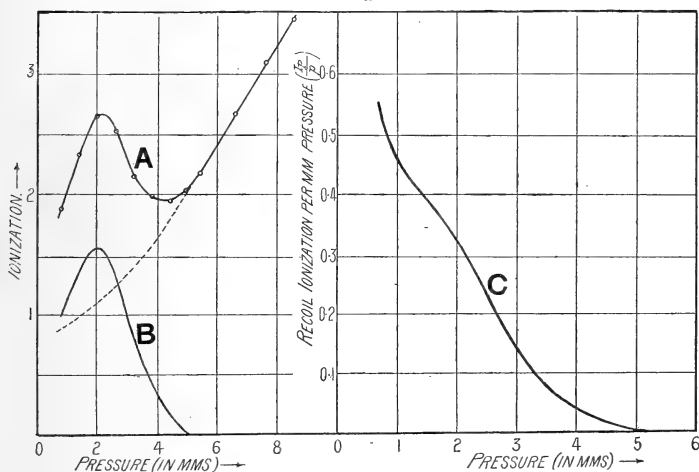

of ordinates (ionization) above the origin. This may be due to the production of δ rays in the ionization vessel by impact of the α -particles.

To estimate the ionization produced by the recoiling atoms then, it is necessary to perform two experiments, (a) with the active plate uncovered, (b) with the plate covered with a layer of aluminium just sufficient to stop recoiling atoms. The curve (b) must be plotted subject to a correction for the absorption of the α -particles in the aluminium foil, *i. e.* the linear parts of both curves (a) and (b) must be superposed. Assuming no ionization by collision at low pressures, the difference between the two curves now represents the amount of ionization produced by the recoiling atoms. Fig. 4 is a typical example. The dotted portion in curve A represents the ionization curve of the α -particles, whilst the full-line curve is that due to recoil atoms and α -particles. The

difference between these two curves is shown in curve B. This curve gives the variation of ionization produced by recoil atoms at different pressures.

Assuming that ionization is independent of velocity, the ionization in the chamber due to each recoil atom which passes through it is proportional to the number of collisions it makes with air molecules in the chamber. Hence the ionization per recoil atom is proportional to the pressure within the vessel. But we have seen that the number N of recoil atoms reaching the chamber decreases with increase of pressure owing to absorption in the gas between the source and the chamber. Hence

$$N = N_0\psi(p),$$

where N_0 is the number of recoil atoms leaving the source and $\psi(p)$ is the fraction absorbed in the gas.

Therefore the ionization I_p at any pressure p is given by

$$I_p \propto N_0p\psi(p),$$

i. e.

$$\frac{I_p}{p} \propto \psi(p),$$

a relation giving the form of the absorption curve. Consequently, if we plot the relation between $\frac{I_p}{p}$ and p , we shall obtain a curve giving us the form of the function $\psi(p)$.

Fig. 4, curve C, shows the result of plotting the relation between "ionization per mm. pressure" and "pressure." The general form of the curve was the same in all experiments. It will be noticed that *all* the recoil atoms are prevented from reaching the ionization chamber at a pressure of about 5 mm. The mean value of this pressure was found to be 4.9 mm., corresponding to a range of recoil of .175 mm. in air at atmospheric pressure. The form of the absorption curve is rather peculiar. The ionization per mm. pressure falls rapidly for the first few millimetres pressure, then more slowly and again more rapidly with further increase of pressure. The curve is unlike that obtained by the first method of determining the range—this point will be referred to later.

Recoil from Thorium Active Deposit in Hydrogen.

In these experiments the hydrogen was prepared electrolytically, washed by bubbling through concentrated sulphuric acid, and finally dried by passing over bulbs containing

phosphorus pentoxide. To ensure the removal of all air, the apparatus was filled twice with hydrogen and evacuated.

In this case the form of the curves could be more definitely fixed than in the case of air, since a much greater number of experimental points could be obtained before the pressure at which the recoil atoms were completely stopped was reached. It was observed that ionization is produced by recoiling atoms up to a pressure of 21 mm., corresponding to a range of .74 mm. in hydrogen at atmospheric pressure, *i. e.* a little over four times the range in air.

(b) *Recoil from Actinium Active Deposit.*

In this case the ionization curves did not show such a pronounced "hump" as those obtained for thorium, and the curve connecting "ionization per mm. pressure" and "pressure" showed only one drop. Fig. 5 shows a set of curves of this character, the experiment in the case shown being performed in hydrogen.

Fig. 5.

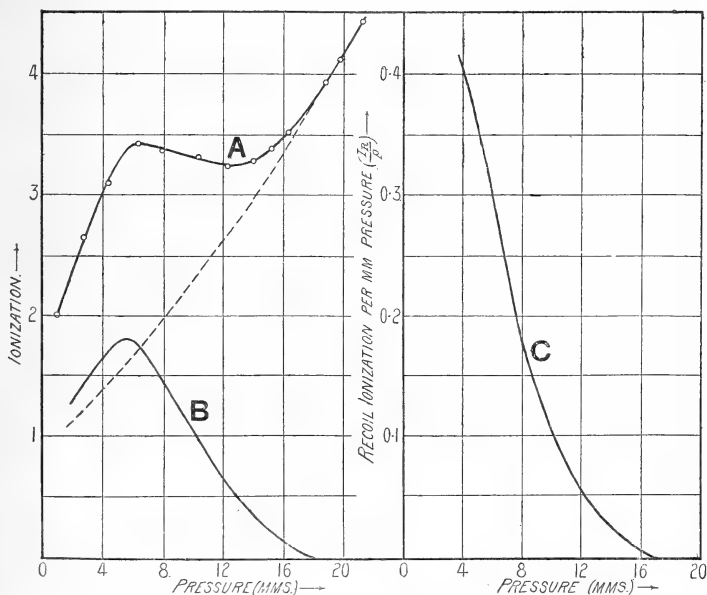

It will be seen that the form of the curve C, unlike that of the thorium curve, is almost identical with the main portion of the curve shown in fig. 2.

In the case of recoil from actinium C the pressure at which the recoil atoms cease to reach the ionization chamber was

about 3.5 mm. in air or about 16 mm. in hydrogen. The mean value for the range of recoil was found by this method to be .126 mm. in air and 0.55 mm. in hydrogen at atmospheric pressure.

III. INTERPRETATION OF RESULTS.

In the case of recoil from actinium C the results obtained by the two methods described above are strikingly similar. Both the range of recoil and the form of the absorption curves are the same by the two different methods.

The results on the recoil from thorium C are, however, not so easy of interpretation. By the first method of experiment the range of recoil was found to be .12 mm. in air at atmospheric pressure. Comparing this result with that obtained for actinium, it appears as if the recoil product came from the atom emitting the α -particle of range 4.8 cm., viz. thorium C. Now it is obvious that the atom emitting the 8.6 cm. range α -particle must have a recoil product of longer range than that from actinium C; consequently, if this product has been collected by the hemisphere, it must either be rayless or it must have a period of not more than a few seconds. The former supposition seems more probable. In the experiments on the ionization produced by recoil from thorium C the form of the absorption curves ($\frac{I_p}{p}$ and p) indicates that the ionization is at first being produced by the products recoiling from both thorium C₁ and thorium C₂, whilst after a certain pressure has been reached the ionization is produced only by the product from thorium C₂. The most satisfactory explanation of these two results seems to be that thorium D recoils from thorium C₁ (emitting α -particles of range 4.8 cm.), whilst the product recoiling from thorium C₂ (emitting α -particles of range 8.6 cm.) is rayless. This result agrees with the scheme suggested by Marsden and Darwin* for the disintegration of the thorium series, viz.:

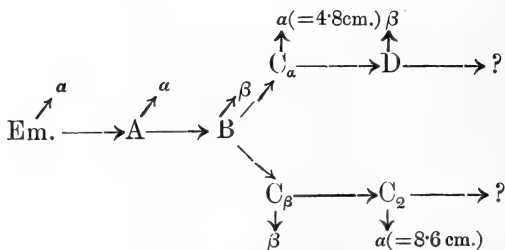

* *Loc. cit.*

SUMMARY.

1. The ranges of recoil from thorium C and actinium C have been determined in air and hydrogen by two different methods, (a) by collecting the recoiling products at different pressures and measuring the activity, (b) by measuring the ionization produced by the recoiling atoms at different pressures.

The results are as follows :—

Parent Product.	Recoil Product.	Range of Recoil in Air.		Range in Hydrogen.	
		1st Method.	2nd Method.	1st Method.	2nd Method.
Actinium C.	Actinium D.	0.12 mm.	0.126 mm.	0.52 mm.	0.55 mm.
Thorium C ₁ .	Thorium D.	0.12 mm.	—	0.55 mm.	—
Thorium C ₂ .	?	—	0.175 mm.	—	0.74 mm.

2. The range of the recoil atom from actinium C is found to be the same both by the activity and ionization methods ; on the other hand, the apparent range of recoil atoms from thorium C is markedly longer by the ionization method.

3. These differences receive a satisfactory explanation by supposing that two distinct groups of recoil atoms are emitted during the transformation of thorium C ; the shorter range group is radioactive, the other rayless.

4. The order of disintegration of the thorium series has been shown to agree with that suggested by Marsden and Darwin (by an entirely different method), viz., thorium D is the product resulting from the disintegration of thorium C₁ (emitting α -particles of 4.8 cm. range). The product result recoiling from thorium C₂ (emitting α -particles of 8.6 cm. range) is probably rayless.

In conclusion I should like to express my sincere thanks to Prof. Rutherford and to Dr. Hans Geiger for suggesting this research, and for much helpful advice during its progress.

Physical Laboratories,
The University, Manchester,
July 1913.

XLIX. *The Absolute Thermal Conductivity of Glass.* By
I. WILLIAMS, M.Sc., *Lecturer in Physics in the University
of Bristol**.

§ 1. **T**HE absolute thermal conductivity of glass has been determined by several independent methods, of which the best known are probably the following:—

(i.) The “divided bar” method.

This method was suggested by Lodge and used by Lees †. A metal rod is cut in two and the distribution of temperature down the whole bar is studied (a) when the cut ends are in intimate contact, (b) when a plate of badly conducting substance is interposed between them.

(ii.) Voigt’s Method.

In this method one surface of the plate is maintained at constant temperature by a current of cold water flowing over it. The other surface is exposed to hot water in a calorimeter. The hot water is thoroughly stirred, and from its rate of cooling the amount of heat transmitted through the plate is determined. This method has been used by Venske ‡ and by Focke §.

(iii.) Christiansen’s Method.

Paalhorn ||, using the well-known three-plate arrangement due to Christiansen, has determined the conductivity of glass in terms of that of air.

(iv.) Lees’s Disk Method.

Lees ¶ has determined the conductivity of glass and other bad conductors by means of a disk method in which the heat energy transmitted is measured electrically.

§ 2. The disk methods just referred to are very convenient for comparing the thermal conductivities of two substances, particularly when the substance is available in small quantities only. In all these methods, with the exception of the second, it is usual to secure good thermal contact between the plate of copper and the plate of substance being tested by interposing a thin layer of glycerine or mercury between the

* Communicated by the Author.

† Lees, *Phil. Trans.* vol. clxxxiii. p. 481 (1892).

‡ Venske, *Göttingen Nachr.* p. 121 (1891).

§ Focke, *Wied. Annalen*, vol. lxxvii. p. 132 (1898).

|| Paalhorn, *Dissertation*, Jena, 1894.

¶ Lees, *Phil. Trans.* vol. xcvi. p. 399 (1898).

plates. Since the flow of heat takes place in a direction perpendicular to the surface of this film of foreign matter, the presence of the latter must introduce a thermal resistance which is uncertain and difficult to eliminate. This is a serious objection to the method when an exact determination of the absolute thermal conductivity is required.

It has occurred to the writer that this difficulty may be surmounted in certain cases by having the substance under test in the form of a hollow cylinder containing a mercury column. The heat energy generated by passing an electric current through the mercury column is easily measured, and the mercury in the tube makes good thermal contact with the inner surface of the cylinder, while running water makes good contact with the outer surface.

§ 3. The experiments about to be described were carried out on the lines indicated in the latter half of § 2, and were undertaken with the object of determining the thermal and electrical conductivities of glass and quartz.

Fig. 1.

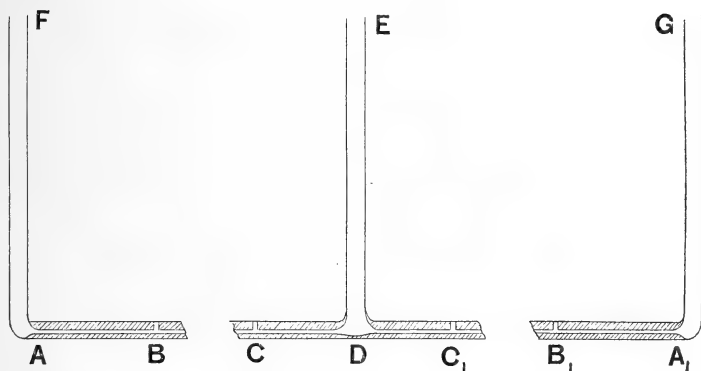

A capillary tube AA_1 , fitted at each end with wide tubes AF and A_1G bent at right angles to AA_1 , is filled with mercury, and electrodes are inserted into the mercury in the tubes AF and A_1G . By means of these electrodes a steady electric current can be passed through the mercury column AA_1 . In the cylindrical portions BC and B_1C_1 , the heat generated by the electric current flows radially through the cylinder and the quantity of heat flowing through per second is easily calculated. In order to eliminate any disturbing effects at the ends of the cylinder considered it is better to make the calculation differentially.

Let

Q = quantity of heat transmitted radially per second through unit length of the glass cylinder AA_1 ;

r_1 = internal radius of AA_1 ;

r_2 = external " " " ;

θ_1 = temperature of the inner surface of the glass tube AA_1 ;

θ_2 = temperature of the outer surface of the glass tube AA_1 ;

E = potential difference in volts at the ends of a mercury column of length l ;

C = heating current in amperes;

$J = 4.18 \times 10^7$ ergs;

k = coefficient of thermal conductivity of glass.

The energy generated per second in a length l cm. of mercury by the electric current is EC joules or $\frac{EC}{4.18}$ calories.

It can easily be shown that for an infinite cylinder

$$Q = \frac{2\pi k(\theta_1 - \theta_2)}{\log_e \frac{r_2}{r_1}}.$$

If

E_1 = P.D. in volts at the ends of the mercury column BC ,

E_2 = P.D. in volts at the ends of the mercury column B_1C_1 ,

then the quantities of heat energy generated in BC and B_1C_1 are respectively E_1C and E_2C .

Assuming that the end corrections for the two lengths BC and B_1C_1 are identical, it follows that the heat energy transmitted through a length $BC - B_1C_1$ is equal to $(E_1 - E_2)C$.

$$\begin{aligned} \therefore k &= \frac{(E_1 - E_2)C}{4.18} \log_e \frac{r_2}{r_1} \cdot \frac{1}{2\pi(l_1 - l_2)(\theta_1 - \theta_2)} \\ &= \frac{A(E_1 - E_2)C}{\theta_1 - \theta_2}, \end{aligned}$$

where A is a constant, $BC = l_1$ and $B_1C_1 = l_2$.

§ 4. For the purpose of measuring the potential differences E_1 and E_2 , electrodes were inserted into the mercury column through holes drilled into the capillary at B , C , B_1 , and C_1 . Outside the tube these electrodes were coated with a thick layer of varnish to insulate them from the water in which the apparatus stood. E_1 and E_2 were measured with a millivoltmeter calibrated by means of a cadmium cell.

The measurement of the temperature difference presents rather more difficulty. In the earlier experiments a tube

DE was fused into AA₁ at D, and an insulated thermo-junction was put down into the mercury in D. The tube DE (fig. 2) was surrounded by a vacuum jacket HKMNL. It was hoped that the temperature of the mercury in D would ultimately be the same as that of the mercury in the capillary. This arrangement gave very unsatisfactory results, and the readings taken indicated clearly that the mercury in the small bulb D was at a higher temperature than that in the capillary tube.

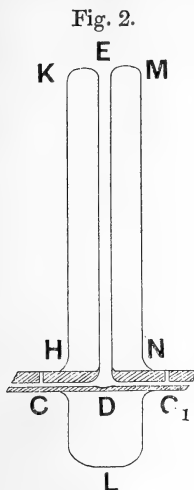
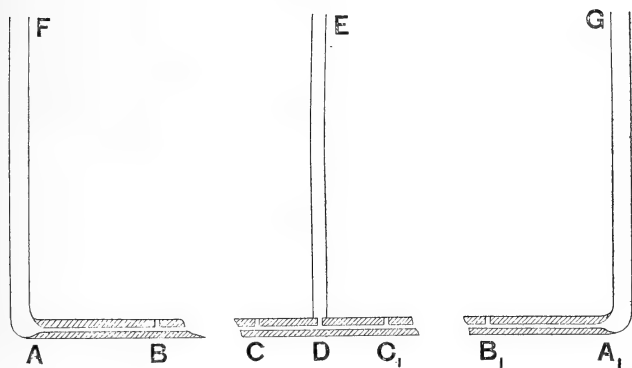

Fig. 2.

§ 5. The arrangement finally adopted is shown in fig. 3. A hole was drilled into the capillary at D, and an insulated thermo-junction was inserted through this hole directly into the mercury in the capillary. There was no bulb at D, and consequently the cross-section of the mercury column was practically undisturbed.

The thermocouple used was made of copper-constantan. The two wires proceeding from each junction were carefully insulated from one another by means of rubber tubes. Each pair of wires was fitted into a narrow glass tube about eight inches

Fig. 3.



long and open at both ends. The junctions themselves protruded about five millimetres from these tubes and were insulated by means of a layer of varnish. The open ends of the glass tubes, next to the junction, were then closed up with cement. One junction was inserted into the mercury column through the small hole D (fig. 3), and the glass tube DE surrounding the junction was cemented to the capillary

at D. The other junction was placed in the cold water in which the apparatus was immersed.

The electric currents employed to heat the column of mercury varied in magnitude from 3.5 to 5 amperes. The readings of the ammeter were calibrated by passing the current through a known resistance and comparing the potential differences between the ends of this resistance with that produced by a cadmium cell. The calibration numbers obtained in this way are given in the following table:—

Ammeter Readings. amps.	Corrected Readings. amps.
3.50	3.49
4.00	3.96
4.50	4.49
5.00	4.98

The potential differences E_1 and E_2 were measured as indicated in § 4 with a millivoltmeter which had been standardized by means of a cadmium cell.

In some of the earlier experiments the Crompton potentiometer was used to measure the currents and potential differences directly, but ultimately it was found more convenient to use direct-reading instruments which had been previously calibrated by means of a potentiometer.

The capillary tube had a very uniform bore, and its mean internal diameter was determined by means of a mercury thread. The mean external diameter was determined by means of a screw-gauge. The apparatus had the following dimensions:—

$$AB = A_1B_1 = 5 \text{ cm.}$$

$$CD = C_1D = 2.5 \text{ cm.}$$

$$BC = 44.0 \text{ cm.}$$

$$B_1C_1 = 22.0 \text{ cm.}$$

$$\text{Mean internal diameter of capillary} = .100 \text{ cm.}$$

$$\text{,, external ,, ,,} = .663 \text{ cm.}$$

§ 6. In carrying out an experiment, the apparatus shown in fig. 3 was placed in a tank through which a rapid flow of cold water was maintained. The temperature of this water was read at regular intervals by means of a standard thermometer graduated in $\frac{1}{10}^\circ \text{C}$. The electric current was then put on and the regulating resistance adjusted whenever necessary so as to maintain the current quite constant. The rapid flow stirred the water in the tank very thoroughly, and its temperature during a reading did not vary by $\frac{1}{10}^\circ$.

Thorough stirring is essential, because if the water is allowed to remain at rest for a very short space of time, the readings obtained are inconsistent.

The couple can be easily calibrated in position at any time in the following way. The water in the tank is allowed to stand until its temperature is equal to that of the room. The cold junction is then removed from the tank and placed in ice or in cold water. The deflexions corresponding to these temperature differences are then observed and a graph plotted. The graph given in fig. 4 was plotted from the following observations:—

Galvanometer Deflexion. mm.	Temperature Difference. °C.
43.4	3.59
56.7	4.68
85.2	7.01
115.5	9.55
138.6	11.46
183.0	15.10

Fig. 4.

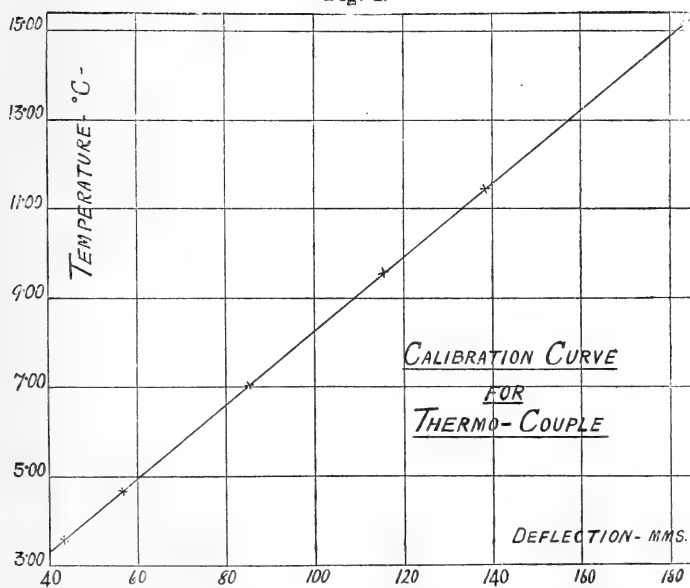

The mean value of 1 mm. deflexion was thus found to be 0.82° C.

The results obtained from sixteen determinations are given in the following table:—

Current, amps.	$E_1 - E_2$, volts.	Deflexion, mms.	$\theta_1 - \theta_2$.	θ_2 .	Mean Temp. θ .	$k \times 10^6$.
3.49	.980	59.7	4.92	16.20	18.7	2268
3.96	1.122	77.7	6.41	16.20	19.4	2264
4.49	1.261	98.4	8.12	16.20	20.3	2278
4.88	1.365	116.8	9.64	16.20	21.0	2258
3.49	.970	58.8	4.85	15.87	18.3	2279
3.96	1.109	78.0	6.43	15.90	19.1	2228
4.49	1.246	99.5	8.21	15.90	20.0	2226
4.98	1.380	122.5	10.10	15.92	21.0	2221
3.49	.970	58.6	4.83	15.60	18.0	2286
3.96	1.105	77.1	6.36	15.65	18.8	2246
4.49	1.244	98.3	8.11	15.75	19.8	2249
4.98	1.380	122.3	10.09	15.70	20.7	2225
3.49	.968	58.7	4.84	15.70	18.1	2279
3.96	1.103	78.0	6.43	15.70	18.9	2216
4.49	1.244	97.7	8.06	15.72	19.7	2264
4.98	1.380	122.3	10.09	15.70	20.7	2225

Mean value of $k = .00225$.

§ 7. Temperature Coefficient of k .

The preliminary experiments which have already been made on the temperature coefficient of k indicate that the method is quite satisfactory for making accurate determinations of this quantity. Experiments are now being made on glass and quartz.

Physical Laboratory,
University of Bristol,
June 1913.

L. On the Gradient of the Penetrating Radiation from the Earth. By LOUIS V. KING, B.A., Assist. Professor of Physics, McGill University, Montreal*.

Sect. 1. Introduction.

IT was first shown by Eve † that, if the penetrating radiation is due to γ -rays from the radio-active constituents of the soil, the intensity should decrease rapidly with height above the earth's surface and should be easily measurable.

* Communicated by Prof. A. S. Eve.

† Eve, Phil. Mag. xxi. Jan. 1911, pp. 26-46.

The analysis was extended by the writer * and the gradient expressed in terms of a transcendental function denoted by

$$f(x) = e^{-x} + x\text{Ei}(-x), \dots \dots \dots (1)$$

$\text{Ei}(-x)$ representing Glaisher's exponential integral. The function $f(x)$ is of special importance in all problems relating to radiation from plates which radiate from each element of volume and also absorb their own radiations exponentially †.

The object of the present note, undertaken at the suggestion of Professor A. S. Eve, is to set forth the formulæ for the gradient of the penetrating radiation and interpret them numerically in terms of the constants which have been determined since the papers above referred to were published. A brief account of existing observations bearing on the subject is also given and the results discussed.

Sect. 2. Calculation of the Gradients of the Penetrating Radiation.

The following notation is employed in the sequel :—

n_1 = number of ions produced per second per c.c. at a height z_1 above the earth's surface.

n_2 refers to the number of ions produced per c.c. per sec. in a small cavity at a depth z_2 below the earth's surface.

μ_1 and μ_2 are the mean coefficients of absorption of γ -rays by air at ordinary pressure and temperature of rock respectively.

For air Chadwick ‡ obtains the value $\mu_1/D_1 = \cdot 048$, D_1 being the density of the air : this gives $\mu_1 = 6 \cdot 0 \times 10^{-5} \text{ cm.}^{-1}$, considerably higher than the value previously obtained by Eve § and Hess || ($\mu_1 = 4 \cdot 4 \times 10^{-5} \text{ cm.}^{-1}$ and $4 \cdot 47 \times 10^{-5} \text{ cm.}^{-1}$, respectively).

For rock Rutherford ¶ takes the value $\mu_2/D_2 = \cdot 04$, not very different from the value obtained by McClelland ($\mu_2/D_2 = \cdot 034$). Taking as a rough value $D_2 = 3 \cdot 0$, we have $\mu_2 = \cdot 12 \text{ cm.}^{-1}$.

We denote by n_0 the number of ions produced per c.c. per second in air at normal temperature and pressure at a distance

* King, *Phil. Mag.* xxiii. Feb. 1912, p. 242.

† Applications to radiation problems are given by the writer, King, *Phil. Trans.* 495 A, vol. cexii. p. 375 (1913).

‡ Chadwick, *Proc. Lond. Phys. Soc.* xxiv. p. 153 (1912).

§ Eve, *Phil. Mag.* July 1911, p. 12.

|| Hess, *Phys. Zeit.* xii. Nov. 1911, p. 998.

¶ Rutherford, 'Radio-activity,' 1913, p. 637.

of 1 cm. from 1 curie of radium supposed concentrated at a point (absorption of γ -rays by air and by the substance of the radium salt neglected).

Eve* obtains for the value of n_0 the number $n_0 = 3.74 \times 10^9$, while a more recent determination by Moseley and Robinson † gave the value $n_0 = 6 \times 10^9$.

Q represents the mean radium content for sedimentary rocks. A table of value for various rocks as determined by Strutt is quoted by Rutherford ‡ : a value of the order of $Q = 3.0 \times 10^{-12}$ gram per c.c. of sedimentary rock may be taken to represent a rough value.

If the radium content is distributed uniformly throughout a semi-infinite solid bounded by a plane, the value of n at a height z above the surface is given by

$$n = \frac{2\pi Q n_0}{\mu_2} f(\mu_1 z_1), \quad (2)$$

$f(\mu_1 z_1)$ being the function defined by equation (1). This function has very simple properties, which often enable us to write down without calculation the intensity of radiation in more complicated cases of distribution : thus if we draw a horizontal plane at a depth z_2 below the surface it is easily shown that the contribution to n arising from the distribution of radium below this plane is given by

$$\frac{2\pi Q n_0}{\mu_2} f(\mu_1 z_1 + \mu_2 z_2).$$

Hence by subtraction we obtain the intensity due to a plate of thickness z_2 in the form

$$n' = (2\pi Q n_0 / \mu_2) \{ f(\mu_1 z_1) - f(\mu_1 z_1 + \mu_2 z_2) \}, \quad . . . (3)$$

agreeing with the value obtained in the previous paper, where a numerical table of the function $f(x)$ is given, enabling (2) and (3) to be evaluated. It is shown that n and n' are practically identical if z_2 exceeds 11 cm., so that the entire contribution to the penetrating radiation is limited to that coming from a few centimetres' depth of radium-bearing rock or soil at the earth's surface.

The number of ions produced in a small cavity at a depth z_2 below the surface is easily obtained by writing down the contribution at the surface of a slab of thickness z_2 lying

* Eve, Phil. Mag. Oct. 1911, p. 551.

† Rutherford, 'Radio-activity,' 1913, p. 637.

‡ Rutherford, 'Radio-activity,' 1913, p. 645.

above the cavity and that due to the semi-infinite solid below it : we thus have

$$n_2 = \frac{2\pi Q n_0}{\mu_2} \{1 - f(\mu_2 z_2)\} + \frac{2\pi Q n_0}{\mu_2} = \frac{2\pi Q n_0}{\mu_2} \{2 - f(\mu_2 z_2)\}. \quad (4)$$

We note that when the cavity is at a considerable depth $f(\mu_2 z_2)$ becomes negligible and $(n_2)_\infty = \frac{4\pi Q n_0}{\mu_2}$, agreeing with the value calculated directly to correspond to this condition *. Also if we take $z_2 = 0$, corresponding to the intensity at the earth's surface, we have, since $f(0) = 1$, for the corresponding ionization the value $(n_2)_0 = 2\pi Q n_0 / \mu_2$. In this connexion Rutherford † points out that, if we take $n_0 = 3$ ions per c.c. per sec. to represent the effect of penetrating radiation at the earth's surface and make use of the constants cited at the beginning of the present section, we obtain a value of Q of the correct magnitude, thus affording evidence of the origin of the penetrating radiation as due chiefly to the radium content of the soil. On the other hand, observations made during balloon ascensions have failed to reveal the gradient required by theory : these are discussed in the next section. The gradient of the penetrating radiation above the earth's surface is calculated from (2), and below the surface from (4), making use of the numerical tables in the paper previously cited : the results are tabulated below and are shown

TABLE I.

$\mu z.$	Gradient above earth's surface. $\mu_1 = 6.0 \times 10^{-5} \text{ cm.}^{-1}.$		Gradient below earth's surface. $\mu_2 = .12 \text{ cm.}^{-1}.$	
	z_1 . metres.	$f(\mu_1 z_1).$	z_2 . cm.	$\{2 - f(\mu_2 z_2)\}.$
0.00.....	0	1.000	0	1.000
.05.....	8.3	.828	.42	1.172
.1.....	16.7	.722	.83	1.278
.2.....	33.4	.574	1.67	1.426
.3.....	50	.469	2.50	1.531
.5.....	83	.327	4.16	1.673
.7.....	117	.235	5.83	1.765
1.0.....	167	.148	8.33	1.852
2.0.....	333	.037	16.7	1.963

* King, Phil. Mag. xxiii. Feb. 1912, p. 247. The writer takes the occasion to correct the description of fig. II., which should read: Curve I., $h = .11 \text{ cm.}$; Curve II., $h = 1.1 \text{ cm.}$; Curve III., $h = 11 \text{ cm.}$; Curve IV., $h = \infty$.

† Rutherford, 'Radio-activity,' 1913, p. 637.

graphically in fig. 1. The intensity at the earth's surface is taken to be unity.

Fig. 1.

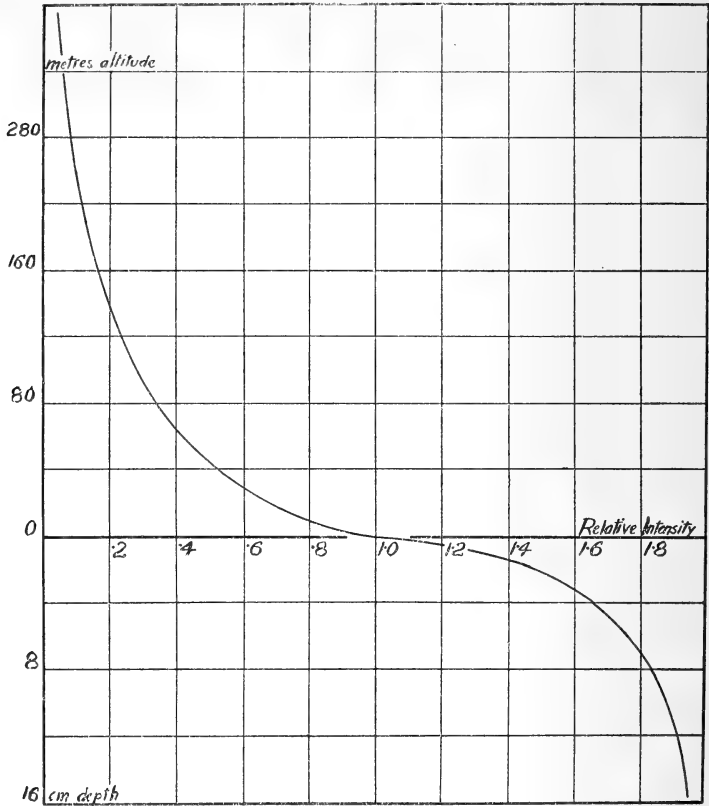

Sect. 3. Discussion of Observations on the Gradient of the Penetrating Radiation.

An excellent summary of the present state of knowledge on the subject of the penetrating radiation, and an account of the difficulties attending the exact measurement of its intensity, has recently been published by A.-B. Chauveau*. An account of attempts to measure the gradient is given in Sect. 18 of the paper just referred to. While it is unnecessary to repeat the summary of the paper quoted, it will suffice to state that observations taken from the top of high buildings

* Chauveau, A.-B., "L'ionization de l'air en vase clos et la radiation pénétrante," Part I., *Le Radium*, x. Jan. 1913, p. 17: Part II., *Le Radium*, x. Feb. 1913, p. 69.

or other structures have a doubtful value both on account of the unknown radium content of the building material and the probability of a contribution to the penetrating radiation being due to a distribution of active deposit from the atmosphere. On the other hand, the results obtained from balloon ascensions have not revealed the required gradient, and as no explanation of the failure has been forthcoming, the writer has ventured to bring forward evidence to show that the results may be vitiated by ionization contributed by radiations from an active deposit on the car of the balloon or even on the electroscope itself. This explanation has already been suggested to explain the variation of Wulf's observations on the Eiffel Tower from the requirements of theory*.

It is well known that balloons may become very highly charged relatively to the surrounding air. An account of the subject is to be found in the Report of the Advisory Committee of Aeronautics, 1909-1910 †. According to evidence there collected (p. 119), and also to experiments and calculations described by G. W. Walker (p. 112), it seems probable that a balloon takes a considerable length of time to attain the potential of the surrounding air. It is probable that in the course of an ascent the balloon may be at a potential differing by several thousand volts from that of the air in its neighbourhood: definite measurements on this point were made by Dieckmann in 1911 during two voyages of a Zeppelin airship ‡.

If this difference of potential should happen to be negative (as in the case of a balloon rising rapidly from a normal negative earth) enough active deposit might be collected on the balloon, its car, and fixtures, and perhaps even on the electroscope itself, to give rise to a penetrating radiation of sufficient intensity to mask that coming from the earth. Flemming § found from balloon observations that at an altitude of 3000 metres about the same amount of active deposit could be collected as at the surface, while Saake || and Gockel ¶ found the amount collected at high altitudes greater than at sea-level.

The explanation just put forward agrees with the trend of

* Chauveau, *loc. cit.* p. 73; Rutherford, 'Radio-activity,' 1913, p. 636

† Published by Wyman & Sons, London, 1910; see also Abstracts, 24, p. 159, and 54, p. 180.

‡ Dieckmann, M., *Zeit. für Flugtechnik und Motorluftschiffahrt*, Jan. 14, 1911. Abstracted in Report of the Advisory Committee for Aeronautics, 1910-11, p. 124.

§ Flemming, *Phys. Zeit.* ix. p. 801 (1908).

|| Saake, *Phys. Zeit.* iv. p. 626 (1903).

¶ Gockel, *Phys. Zeit.* viii. p. 701 (1907).

Hess's observations : a diminution in the ionization due to penetrating radiation was first observed followed by an increase probably due to the gradual accumulation of active deposit.

Sect. 4. *Note on the Origin of the Penetrating Radiation and Conditions to be fulfilled in the Correct Measurement of the Gradient.*

Chauveau * concludes, from a review of existing data, that three sources may contribute to the penetrating radiation :—

(i.) The effect of radio-active matter suspended in the atmosphere contributing $\cdot 1$ to $\cdot 2$ ion per c.c. per sec.

(ii.) The contribution of a layer of active deposit carried down by the electrostatic potential gradient of the atmosphere : contribution 1 to 2 ions and subject to large fluctuations depending on meteorological conditions.

(iii.) The largest contribution of 4–5 ions due to the radium content of the soil : we have already seen that the whole effect is almost entirely due to the surface-layer of a few centimetres' depth.

In the light of the information brought forward in the present paper, the following conditions should obtain in a measurement of the gradient :—

(i.) Observations should be taken over a level plain, consisting of a homogeneous soil in the surface-layer: the radium content of samples taken at a few centimetres' depth, but over as wide an area as possible, should be determined by a separate experiment as well as their coefficients of absorption to γ -rays.

(ii.) The ionization in a cavity a few centimetres deep should be measured: from a practical point of view this is most easily accomplished by placing a shallow wooden box, about 25 centimetres deep, and as wide and broad as possible, on two trestles and measuring the ionization beneath the box as closely as possible to the lower surface. By filling the box to various depths with soil typical of that found in the locality, measurements equivalent to the measurements of the gradients in the earth can be obtained. Corrections for the finite size of the box may be made by means of an analysis similar to that given by the writer for a circular plate †, in which case the formulæ are comparatively simple : this corresponds to making the box referred to circular in shape.

* Chauveau, *loc. cit.* p. 72.

§ King, *loc. cit.* p. 249.

(iii.) Owing to difficulties attending measurements from structures or from balloons it might be advantageous to keep the electroscope at various heights by means of a small pilot balloon capable of being reeled in so quickly that the rate of leak during ascent or descent may be neglected or, at any rate, allowed for: active deposit at various heights should be tested for by means of a dummy electroscope similarly exposed and a correction made if possible. At the time of the observation measurements of the electrostatic potential gradient should be made and a record kept of other meteorological conditions.

McGill University, Montreal,
July 10th, 1913.

II. *The Scattering and Absorption of the γ Rays of Radium.*
By J. A. GRAY, D.Sc.*

IT was discovered by Eve† that secondary γ rays were emitted by any body or radiator through which the γ rays of radium passed, the secondary rays being less penetrating than the primary rays‡. Investigations on the nature of these secondary rays have since been carried out by Kleeman§, Madsen||, and Florance¶, the experiments of Florance giving us perhaps the most definite information. Florance ascribed the secondary γ rays to scattering of the primary rays, as the quality of the secondary rays appeared to be independent of the nature of the radiator. He obtained the important result that the secondary or scattered rays became less penetrating as the angle of scattering increased. It appeared as if much more γ radiation was scattered in the emergent direction than in the incident direction, the scattering being apparently similar to that suffered by a pencil of α or β rays. As the primary rays were heterogeneous, Florance explained his results by assuming that the softer rays were scattered through larger angles

* Communicated by Professor H. T. Barnes, F.R.S.

† Eve, *Phil. Mag.* viii. p. 669 (1904).

‡ In this paper γ rays striking a body or radiator are referred to as primary rays, rays coming off from the radiator in a different direction as secondary rays. The secondary rays are ascribed to scattering, and the angle between the direction of these rays and that of the primary is called the angle of scattering.

§ Kleeman, *Phil. Mag.* xv. p. 638 (1908).

|| Madsen, *Phil. Mag.* xvii. p. 423 (1909).

¶ Florance, *Phil. Mag.* xx. p. 921 (1910).

than the primary, and this is the explanation usually given*.

The writer† came to the conclusion that γ rays could be directly scattered, but further consideration of the experiments of Madsen and Florance showed that the interpretation of the scattering of γ rays given above was probably not sufficient, as it appeared that when the intensity of the primary rays was diminished by lead, the softer scattered rays were not cut down so quickly as one would expect (see the tables given below). The question of the scattering of γ rays has, therefore, been re-examined to some extent, and the results obtained show that γ rays are not scattered like a pencil of α or β rays, the main explanation of properties of the secondary γ rays being that when γ rays are scattered the scattered rays are softer, the softening being greater the greater the angle of scattering. In support of this view it may be stated that Sadler and Mesham‡ have found that when homogeneous X rays are scattered in carbon the scattered rays are less penetrating. Below are given a description of the experiments on secondary γ rays, and a discussion of the results and their bearing on absorption experiments.

Experimental Arrangements and Results.

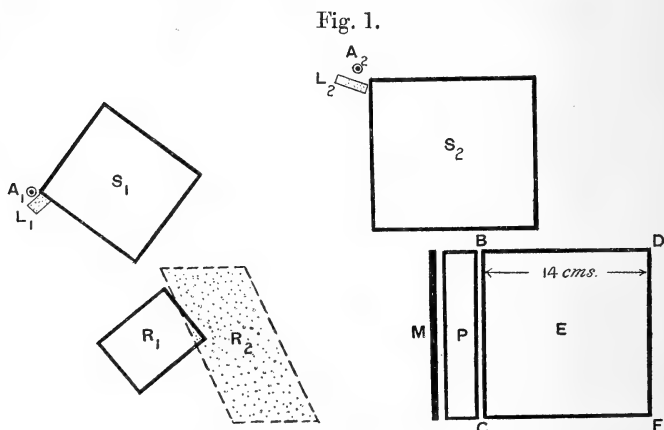

Fig. 1 (drawn to scale) shows a horizontal section of the apparatus used. For a source of γ rays, 15 milligrams of

* Bragg, 'Studies in Radioactivity.' Rutherford, 'Radioactive Substances and their Radiations.'

† Gray, Proc. Roy. Soc. A. lxxxvii. p. 489 (1912).

‡ Sadler and Mesham, Phil. Mag. xxiv. p. 138 (1912).

radium bromide was used. This was enclosed in a sealed glass tube, the latter being placed in a lead cylinder, the lead being 1.7 mm. thick. A_1 , A_2 represent different positions of the active material, R_1 , R_2 corresponding positions of the radiators, S_1 , S_2 blocks of lead to screen the electro-scope E from direct γ radiation, L_1 , L_2 lead plates to cut down the intensity of the primary radiation, and M a lead plate to test the penetrating power of the scattered radiation from the radiator. The electro-scope E was a 14 cm. cube, and all sides except the vertical sides BC and DF were of iron 1 mm. thick covered by lead 2 mm. thick. The scattered rays entered the electro-scope through the side BC, and this was closed by aluminium 1/60 mm. thick, and in front of this was placed a carbon plate P 2.7 cm. thick. The carbon cut off β rays from the radiators and only a small percentage of γ rays. The side DF was closed by aluminium 1/60 mm. thick, and behind this was placed a plate of carbon 1 cm. thick and a lead plate 2 mm. thick. The electro-scope and radiators were supported by as little material as possible, all supports being covered by lead to reduce the effect of any secondary radiation from them.

In the position A_1 , R_1 the angle of scattering was about 50° . Three radiators were used, viz.:—

- A carbon radiator 12.5 cm. high, 7.5 cm. broad, and 5.84 cm. deep, mass 923 grammes;
- an iron radiator 12.9 cm. high, 8 cm. broad, and 1.28 cm. deep, mass 1020 grammes;
- a lead radiator 11 cm. high, 7.6 cm. broad, and .88 cm. deep, mass 840 grammes.

In the position A_2 , R_2 the angle of scattering was about 110° , and the following radiators were used:—

- A carbon radiator 15 cm. high, 15 cm. broad, and 6.4 cm. deep;
- an iron radiator 15 cm. high, 15 cm. broad, and 1.7 cm. deep;
- a lead radiator 15 cm. high, 15 cm. broad, and 0.3 cm. deep.

Readings were taken with and without the radiator, the difference being due to the scattered radiation. The intensity of the primary rays was measured directly. The readings are given in Tables I. and II. in divisions per minute. The reading without a radiator varied between 3.5 and 7 divisions per minute.

TABLE I.
Angle of scattering 50°.

(a) Intensity of primary rays, 100. Lead L_1 , 0.0 mm.			
Intensity of scattered rays.			
Thickness of lead M.	Carbon.	Iron.	Lead.
0.0	5.40	4.90	1.64
1.0	3.61	3.50	1.31
3.0	2.39	2.35	1.00
6.0	1.54	1.50	0.72
10.0	0.92		
15.0	0.48		

(b) Intensity of primary rays, 42.4. Lead L_1 , 1.29 cm.			
Intensity of scattered rays.			
Thickness of lead M.	Carbon.	Iron.	Lead.
0.0	1.93	1.80	0.70
1.0	1.36	1.32	0.60
6.0	0.67	0.64	0.35

(c) Intensity of primary rays, 23.0. Lead L_1 , 2.58 cm.			
Intensity of scattered rays.			
Thickness of lead M.	Carbon.	Iron.	Lead.
0.0 ..	0.85	0.89	0.36
1.0	0.66	0.67	
6.0	0.38	0.39	

These figures show at once that the usual explanation of the scattering of γ rays cannot be quite correct. Take Table II. The scattered radiation is reduced to about 12 per cent. of its value by a lead plate 3 mm. thick. If these rays were due to the softer rays being scattered through larger angles, we should expect that a lead plate 3 mm. thick placed before the active material would reduce the scattered radiation to the same extent. It takes, however, over 3 cm. of lead to do this. Similar results are to be

TABLE II.
Angle of scattering 110° .

(a) Intensity of primary rays, 100. Lead L_2 , 0.0 mm. thick.			
Intensity of scattered rays.			
Thickness of lead M.	Carbon.	Iron.	Lead.
0.0	4.37	3.67	0.57
1.0 mm.....	1.35	1.34	0.36
3.0 mm.....	0.37	0.38	
(b) Intensity of primary rays, 60. Lead L_2 , 0.74 cm. thick.			
Intensity of scattered rays.			
Thickness of lead M.	Carbon.	Iron.	Lead.
0.0	1.94	1.85	0.34
1.0 mm.....	0.74	0.70	
3.0 mm.....	0.23	0.23	
(c) Intensity of primary rays, 32.5. Lead L_2 , 1.84 cm. thick.			
Intensity of scattered rays.			
Thickness of lead M.	Carbon.	Iron.	
0.0	1.05	1.00	
1.0 mm.....	0.47	0.47	
(d) Intensity of primary rays, 19.0. Lead L_2 , 2.94 cm. thick.			
Intensity of scattered rays.			
Thickness of lead M.	Carbon.	Iron.	
0.0	0.56	0.54	

obtained from Table I. It is evident, therefore, that some change must take place in the quality of the γ rays when they penetrate matter, either direct or by scattering. The possible production of characteristic radiations is not considered, as the quality of the secondary rays is very nearly

independent of the nature of the radiator. There seem to be two possible explanations.

(1) γ rays become softer the more matter they penetrate, not taking into account any possible effect due to scattering. We should then have a continuous production of soft γ rays, and the former explanation of scattering might hold good.

(2) When homogeneous γ rays are scattered there is a change of quality, the scattered rays being softer the greater the angle of scattering.

With respect to the first possibility there is no evidence of such a transformation. Experiments on characteristic X radiations indicate that the rays are homogeneous and suffer no change in direct transmission through matter except by being diminished in intensity. Even admitting this possibility there are other difficulties. In the experiments of Madsen and Florence the scattered rays had to pass through a certain amount of lead before entering the electroscope. As lead absorbs the incident rays so much more quickly than the harder emergent rays their results may not give a fair comparison. To test this the following experiment was made.

Readings were taken of the relative intensities of the radiations scattered from a carbon radiator in directions making angles 35° , 90° , 130° with that of the primary rays. The carbon radiator was the one used previously in scattering experiments (Table I.). The same electroscope E was used, the scattered rays entering and leaving the electroscope through carbon plates.

A_1 , A_2 , A_3 (fig. 2) represent three positions of the active material equidistant (31.5 cm.) from the radiator R. The electroscope was screened as before. The absorption of primary rays in the radiator was about the same in each case. The readings obtained were:

A_1 ,	angle of scattering	35° ,	scattered radiation	1.40.
A_2 ,	„	„	90° ,	„ „ 0.61.
A_3 ,	„	„	130° ,	„ „ 0.63.

We should correct for absorption of the scattered radiation in the radiator and in the carbon plate in front of the electroscope. Correcting for absorption in the latter plate the numbers become

$$1.77, \quad 0.82, \quad 0.99.$$

It thus appears as if less radiation is scattered through 90°

than through other angles, and as if very little more radiation was scattered in the emergent direction than in the incident. The similarity to the scattering of X rays will be noted, and although the experiments are only approximate.

Fig. 2.

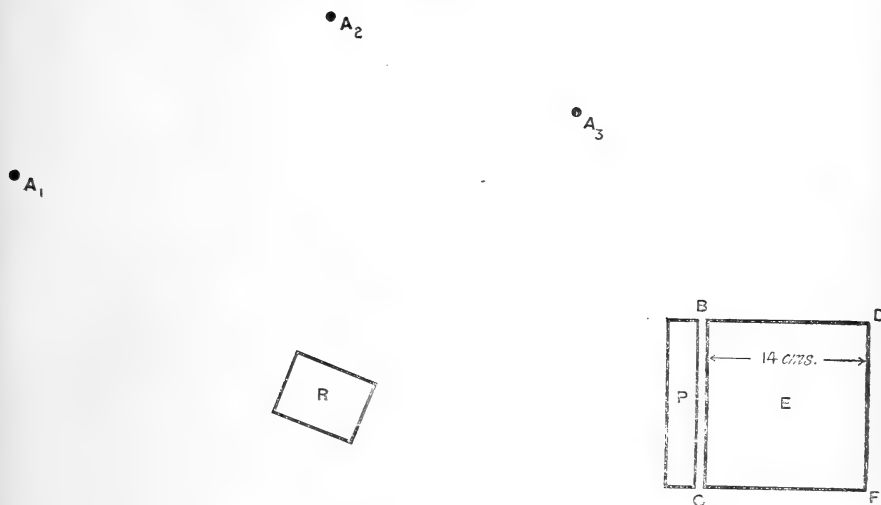

we can say that the scattering of a beam of γ rays is not at all similar to that of a pencil of α or β rays. There is little doubt that the scattering of X and γ rays is the same in character, there being probably gradual changes in the quality and distribution of the scattered radiation as the X or γ radiation increases in penetrating power. With the different types of γ rays at our disposal there is probably very little change in the distribution of the scattered radiation as the penetrating power varies, although the softer the rays the more they are scattered per unit mass.

The primary rays in the present case are always heterogeneous, and if we suppose there is no change in quality produced by scattering and neglect absorption in the radiator, the scattered rays would be softer on the whole, but there would be no change in quality as the angle of scattering increased. Further, after passing through a few millimetres of lead, the scattered rays would be of about the same penetrating power as the primary. We are therefore forced to the second explanation, and this is quite sufficient. The change in quality is probably very small when the angle of scattering is small, as experiment shows that in this case the scattered

rays do not differ much in penetrating power from the primary. A certain similarity to the scattering of α rays may here be noted. When an α ray is scattered through a large angle there is little doubt that it loses velocity, the loss being greater the greater the angle of scattering.

It was stated above that Sadler and Mesham found that X rays are softened by scattering. The change in quality appeared to be greater the greater the penetrating power of the X rays, and this point is supported by the present experiments, the γ rays scattered through an angle of 110° being not much more penetrating than the rays excited in lead by the γ rays of radium E. It seems quite probable that the change in quality is small for very soft X rays. It will be seen that the rays scattered through 50° are still much softer than the primary rays even after passing through a centimetre of lead, so the softening must happen to every type of γ ray scattered.

We can deduce the following results from the tables:—

1. The quantity of radiation scattered per unit mass is approximately independent of the nature of the radiator.

At first sight it would appear that lead scattered much less γ radiation per unit mass than either carbon or iron. This, however, is mainly due to the fact that lead absorbs the scattered radiation so much that less of it escapes from the radiator.

Consider Table I. (b). The primary rays pass through the radiator approximately normally, the scattered rays at an angle of 50° with the normal. If μ is the absorption coefficient of the primary, λ that of the scattered rays, ρ the density, A the area, d the depth of the radiator, the amount of scattered radiation entering the electroscope will be approximately proportional to

$$\int_0^d \rho A e^{-\mu X} e^{-\lambda(d-X) \sec 50^\circ} dX, \text{ i. e. } \frac{\rho A}{\lambda \sec 50^\circ - \mu} (e^{-\mu d} - e^{-\lambda d \sec 50^\circ}),$$

or S, say,

For carbon	$\rho = 1.68,$	$A = 94 \text{ sq. cm.},$	$d = 5.84 \text{ cm.},$
	$\mu = 0.074,$	$\lambda = 0.118,$	$S = 444.$
,, iron	$\rho = 7.7,$	$A = 104 \text{ sq. cm.},$	$d = 1.28 \text{ cm.},$
	$\mu = 0.30,$	$\lambda = 0.62,$	$S = 468.$
,, lead	$\rho = 11.4,$	$A = 84 \text{ sq. cm.},$	$d = 0.88 \text{ cm.},$
	$\mu = 0.56,$	$\lambda = 1.83,$	$S = 212.$

These numbers (S) agree fairly well with the experimental values. Carbon and iron give about the same value, and lead

about 45 per cent. that of iron. The scattered radiation from the lead was actually found to be about 40 per cent. of that from the iron.

Now consider Table II. (b). In this case the scattered radiation leaves the radiator from the same side as the primary rays enter and makes about the same angle with the normal. Assuming the radiators to be thick enough to give the maximum amount of scattered radiation, the intensity of scattered radiation will be approximately proportional to $\rho/\mu + \lambda$, ρ , μ , and λ having the same meaning as before.

For carbon	$\rho = 1.68,$	$\mu = 0.074,$	$\lambda = 0.132,$
	$\rho/\mu + \lambda = 8.2 ;$		
,, iron	$\rho = 7.7,$	$\mu = 0.30,$	$\lambda = 0.75,$
	$\rho/\mu + \lambda = 7.3 ;$		
,, lead	$\rho = 11.4,$	$\mu = 0.56,$	$\lambda = 6.90,$
	$\rho/\mu + \lambda = 1.5 ;$		

or about 5 times as much radiation should escape from the carbon and iron radiators as from the lead radiator ; and this is what is found experimentally. The quantity scattered is therefore approximately independent of the radiator.

2. The quality of the radiation scattered depends on the angle of scattering, and not on the nature of the radiator.

The tables show very well Florence's result that the greater the angle of scattering the softer the radiation. Florence found that after the rays passed through 6 millimetres of lead the quality of the scattered radiation was approximately independent of the radiator. In the present case, the rays from the lead radiator are on the whole more penetrating, but this is mainly due to the much greater absorption of the softer rays in the lead radiator.

3. The softer the γ radiation the greater the percentage of it scattered per unit mass.

It is well known that when the γ rays of radium pass through lead they become on the whole more penetrating. (See figures for intensity of primary rays.) As the primary rays are "hardened," the scattered radiation should become more penetrating. This has been proved by Madsen and Florence, and can be seen in Tables I. and II. If the softer rays are scattered more per unit mass than the harder rays, and we compare the intensity of the scattered radiation with that of the primary, the ratio of the two should decrease as the rays become "harder." The ratio does decrease ; *e. g.* when the primary rays pass through a lead screen 1.29 cm. thick, the intensity of the scattered rays from carbon is

reduced from 5.40 to 1.91, or to 35 per cent., while the intensity of the primary radiation falls to 42 per cent. Similar results are to be obtained from Table II. In the case of the scattered radiation from lead the much greater absorption of the softer rays, both primary and scattered, vitiates this comparison.

The fact that softer rays are scattered to a greater extent is, of course, to be expected. In a previous paper the writer introduced a coefficient S_1/ρ , $S_1 dx$ representing the intensity of the radiation scattered for a parallel beam between the angles 90° and 270° .

In the case of X rays S_1/ρ is of the order 0.100.

In the case of γ rays of radium E S_1/ρ is of the order 0.050. In the present case a special experiment showed that a carbon radiator reflects about 12 per cent. of the γ rays of radium E, and it is easy to prove that if μ represents the absorption coefficient of the primary rays in carbon, λ the absorption coefficient of the reflected rays, and P the fraction of rays reflected,

$$S_1/\rho = P(\mu + \lambda)/\rho.$$

For carbon, $\mu/\rho = 0.044$, $\lambda/\rho = 0.080$, $P = 0.12$,

$$\text{and } S_1/\rho = 0.015,$$

showing that the scattering decreases as the rays become harder.

The numbers, although approximate, are sufficiently accurate to show that the scattering of γ rays is quite marked in comparison with direct absorption. For this reason it is practically impossible to separate the primary and scattered rays, and these scattered rays play a great part in absorption phenomena.

Absorption of γ Rays.

When examined by most materials, the γ rays of radium become more and more penetrating, this being particularly marked in the case of absorption by lead and other substances of high atomic weight. After passing through a certain amount of any material the absorption becomes exponential, Russell* finding that the absorption in mercury is exponential for a thickness of 1 cm. to 22.5 cm., the intensity diminishing in the ratio 360,000 to 1.

The tables show us that even though the absorption is exponential, the rays are not homogeneous owing to scattered

* Russell, Proc. Roy. Soc. A. lxxxvii. (1912).

γ rays being softer than the primary. Ordinarily we should expect the rays to become more and more penetrating and ultimately homogeneous. That this is not the case is of course explained by the fact that although the softer rays are more quickly absorbed, their place is taken by other rays produced by scattering. Consider a homogeneous beam of γ rays. As a certain fraction of these rays is scattered per unit mass, the rays coming through any absorption plate would become less and less penetrating as the thickness of the plate increased. Ultimately, however, the absorption would become exponential, as only a definite fraction of the unscattered primary rays, which would consequently be unchanged in quality, could be scattered per unit mass, and we must reach a stage where the production of softer γ rays is balanced by their absorption. A certain similarity to the absorption of β rays will be noted. In the case of β rays the slower β rays are produced by the faster β rays losing velocity in traversing matter. One distinction must be drawn, however. In the case of β rays, true absorption only takes place to any great extent when the rays become very slow, whereas in the case of γ rays absorption can take place at any point of their path.

The writer * has shown that an exponential law for β rays can only be approximate, and the question arises as to whether the same thing may not be true for γ rays. This depends on the question: Can γ rays be directly scattered? Crowther † has shown that of a pencil of β rays every β ray is scattered through a small angle after passing through very small thicknesses of matter, and Geiger ‡ has shown the same thing for α rays. If something similar took place in the case of γ rays, we should have the result that γ rays, as a whole, must become less and less penetrating so that, like β rays, an exponential law could only be approximate, the absorption ultimately becoming greater and greater. If, on the other hand, we start with a beam of γ rays and a definite percentage of these rays is scattered per unit mass, the remainder keeping their direction unchanged, the exponential law can be an accurate one. The fact that Russell found the absorption in mercury exponential over a range of intensity of 360,000 to 1, shows that this is very nearly the case, and this has been tacitly assumed above, although Russell found evidence that

* Gray, Proc. Roy. Soc. A. lxxxvii. p. 486 (1912).

† Crowther, Proc. Roy. Soc. A. lxxx. p. 186 (1908).

‡ Geiger, Proc. Roy. Soc. A. lxxxi. p. 174 (1908), and A. lxxxiii. p. 492 (1910).

the γ rays of radium could not penetrate more than 26 cm. of mercury.

The tables show that much less scattered radiation escapes from a lead radiator than from a carbon radiator; consequently when the rays are exponentially absorbed by the two materials, the rays coming through carbon will be more heterogeneous than those coming through lead. If γ rays are being exponentially absorbed by carbon and aluminium, the issuing rays will not be exponentially absorbed by the lead, as they contain too great a proportion of soft rays. When examined by lead these softer rays will be cut out until the γ rays are exponentially absorbed by lead, *i. e.* lead will harden the rays. Evidence for this is found in recent experiments of Rutherford and Richardson*, who found that γ rays exponentially absorbed by aluminium are "hardened" by lead. We may generalize this result by saying that rays which are absorbed exponentially by any material are hardened by substances of higher atomic weight. On the other hand, rays which are exponentially absorbed by lead would probably be softened when passed through carbon, or γ rays which are absorbed exponentially by any substance are "softened" by substances of lower atomic weight. Here the terms softened and hardened are used to indicate a greater or smaller proportion of softer rays. These results only apply to the cases where it is safe to say that as the γ rays become softer the absorption per unit mass increases with the atomic weight of the absorber.

The experiments are being continued, and the writer hopes to give, in a later paper, a fuller discussion of the points considered.

Summary.

1. When γ rays are scattered, there is a change in quality, the scattered rays being less penetrating the greater the angle of scattering. The change is gradual and small when the angle of scattering is small.

2. A similar explanation must be given of the scattering of X and γ rays. There is probably very little direct scattering of X and γ rays.

3. The quality and quantity of the scattered radiation is approximately independent of the nature of the radiator.

4. The softer the type of γ rays, the greater the percentage scattered per unit mass.

5. A discussion is given of the bearing of the results on

* Rutherford and Richardson, *Phil. Mag.* xxv. p. 722. (1913).

absorption experiments, and it is shown why an exponential law signifies heterogeneity of the rays. In the case of X rays scattering is in most cases so small compared with absorption that an exponential law probably signifies homogeneity.

In conclusion, the writer wishes to express his best thanks to Prof. Barnes for placing all facilities for this research at his disposal.

McGill University,
Montreal.

LII. *The Distribution of the Active Deposit of Radium in an Electric Field.*—II. By E. M. WELLISCH, Assistant Professor of Physics at Yale University*.

Introductory.

1. **T**HE experiments described in the present paper are a continuation of the investigation made by Wellisch and Bronson† on the distribution of the active deposit of radium in an electric field. In that investigation radium emanation mixed with air was introduced into a cylindrical condenser, and the relative amounts of active deposit which settled on the central electrode and on the case were determined after equilibrium had been established for different positive potentials applied to the outer electrode.

It was shown that the part of the active deposit which settled on the case (anode) was due to the diffusion of uncharged carriers; no evidence was found of the presence of negative carriers in any appreciable amount. It was found also that, when the applied potential was not too small, the distribution of the active deposit was independent of the quantity of emanation employed, and that the fraction of the total amount which settled on the cathode in general increased with increasing potentials, although under the most favourable conditions there was still about 10 per cent. which was deposited on the case. The passage of Röntgen rays through the gas during the exposure was found to be without effect on the distribution except when the applied potential was small, in which case the extra ionization produced by the rays caused increased recombination with the charged active deposit particles, and in this manner the cathode deposit was diminished. Finally, it was found that for potentials which were not too small the ratio of the

* Communicated by the Author.

† Wellisch and Bronson, *Phil. Mag.* [6] xxiii. p. 714 (1912).

equilibrium ionization currents in the gas for two different potentials was equal to the ratio of the corresponding cathode activities.

The main object of the present series of experiments was to extend the investigation in various directions; in particular, it was thought desirable to ascertain the effect on the distribution of employing a containing vessel of different dimensions and of mixing the emanation with gases other than air, and, in addition, to make a detailed investigation of the distribution when small potentials were employed. The main experimental results of the previous research have been confirmed, but the fresh results which have been obtained necessitate a modification of the theory which was suggested in explanation of the phenomena.

Experimental Procedure.

2. The method employed for ascertaining the distribution of the active deposit was the same as that which had previously been employed. The radium emanation obtained usually from a quantity of carnotite, or in some cases from an aqueous solution of a radium salt, was passed into the containing vessel and remained there under the desired conditions of potential, pressure, &c., until radioactive equilibrium was established; in general this period was about 3 hours. The emanation was blown out by means of a strong current of air from a force-pump, and the ebonite plug containing the central electrode was then removed. A fresh electrode was suspended in the vessel, and the ionization current due to the "case" activity was measured at 10 and 15 minutes after the emanation had been removed; the activity on the central electrode was measured by suspending it in a vessel of construction identical with that which contained the emanation, and observing the ionization current at 20 and 25 minutes after the emanation had been removed. The activity when in equilibrium with the emanation was then calculated in the usual manner.

The diagram of connexions is the same as that given in the previous paper, and is reproduced in fig. 1; in the present investigation R and R' were wire resistances of 50,000 and 10,000 ohms respectively. The Dolezalek electrometer had a platinum suspension, and with 120 volts on the needle the sensitiveness was 180 mm. per volt. C and B represent capacities which could be added to the system by means of the key K , and the total capacity of the system was then increased 21 times. A potentiometer device, not shown in the diagram, was employed when measurements of

the ionization current were made; this device enabled the range of swing of the electrometer-needle to be so adjusted that its mid-point coincided with the zero of the instrument,

Fig. 1.

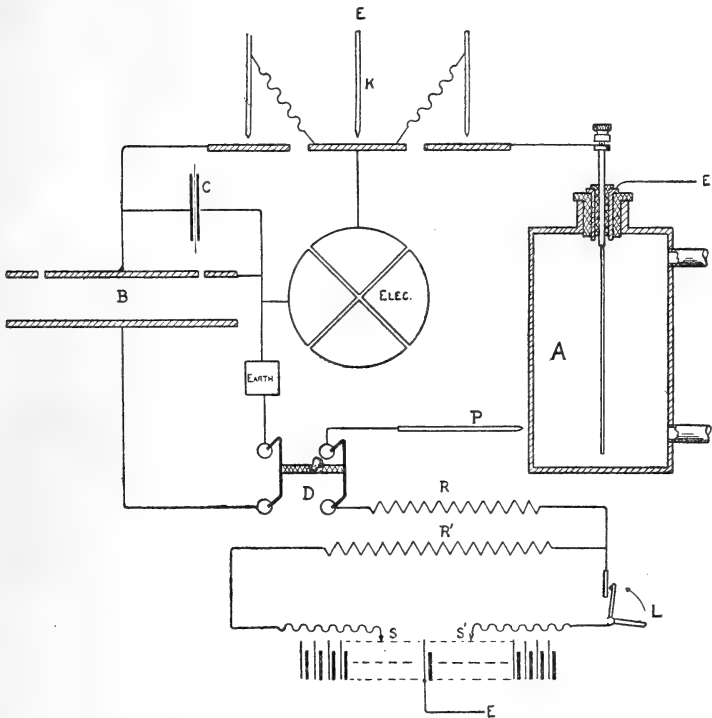

a precaution which was especially necessary when the applied potential was small. Reference should be made to the previous paper for a more detailed account of the apparatus and method of procedure.

Experiments with a Cylindrical Condenser of Small Diameter.

3. In the previous experiments the greatest amount of active deposit that settled on the cathode was about 90 per cent. of the total; this occurred for a potential of 4000 volts. It was of interest to ascertain the effect of applying a large potential across a smaller distance so as to obtain very large values for the electric field. For this purpose two cylindrical vessels were constructed of the following dimensions:—

Height	140 mm.
Inner diameter	19 „
Length of central electrode	101 „

Radium emanation mixed with air at 1 atmosphere pressure was introduced into one of these vessels, and when a positive potential of 3000 volts was applied to the case it was found that about 86 per cent. of the deposit settled on the cathode. In all probability some part of the cathode activity made its way to the ebonite insulation, but there did not appear to be any gain in the cathode deposit as a result of decreasing the cross-section of the containing vessel.

Cathode Deposit in Dry Air at Different Pressures.

4. Throughout the remainder of the experimental investigation, use was made of the two cylindrical vessels which had been employed in the previous research. These vessels were identical in construction and the dimensions of each were as follows:—

Height (inside)	140 mm.
Inner diameter	58 „
Exposed length of central electrode	132 „
Diameter of central electrode . .	1.83 „

The inner electrodes were made longer than those which had previously been employed, and care was taken that no appreciable part of the active deposit was able to settle on the ebonite insulation. During the course of the present experiments a fact was noted which had previously escaped observation. Discrepancies, in general small, occurred in the values for the cathode deposit when the experimental conditions appeared to be identical. Repeated attempts to ascertain the cause of the discrepancies were for a long time unsuccessful, but finally it was ascertained that the inconsistent results arose from the presence of small quantities of water vapour in the gas. In the previous research a test had purposely been made to find the effect of neglecting to dry the gas with which the emanation was mixed; this test appeared to show that the cathode deposit was unaffected by omitting this precaution. However, the fallacy of this result was shown by more thorough investigation. The effect of water vapour is to diminish the cathode deposit, and is especially marked when the gas pressure is high and the applied potential fairly small; in these circumstances an amount of water vapour which was not sufficient to produce any perceptible increase in the recombination of the ions present in the gas might easily diminish the cathode deposit by 30 to 50 per cent. Further illustrations of this effect are given later, but in future experiments extreme care was

taken to dry the gas with which the emanation was mixed. This was done by passing the gas through several tubes containing P_2O_5 and glass-wool before it entered the testing vessel.

The following table gives the values obtained for the cathode deposit expressed as a percentage of the total deposit when the emanation was mixed with dried air at pressures of 210 mm. and 760 mm., and various positive potentials were applied to the case:—

Potential in volts.	Percentage cathode activity.	
	Air at 210 mm.	Air at 760 mm.
20.....	...	65.3
40.....	88.7	74.8
160.....	88.8	83.9
1030.....	89.2	89.2
2000.....	88.8	...
4000.....	...	89.2

These values have been corrected for the amount of uncharged deposit that diffuses to the cathode during the exposure; this correction was made by assuming that the uncharged deposit particles were distributed on the cathode and the case in proportion to the exposed areas, which were as 1 : 50. The figures given represent accordingly the number of positive carriers of activity expressed as a percentage of the total number of carriers.

In order to demonstrate experimentally that the activity which appeared on the anode was almost entirely due to the diffusion of uncharged carriers, several experimental determinations were made of the distribution of the active deposit when a large negative potential was applied to the case. As an example of the results obtained in this connexion, it was found that when the emanation was mixed with dry air at 1 atmosphere and with a negative potential of 160 volts, less than 2 per cent. of the total deposit appeared on the central electrode (anode), showing that no appreciable part of the active carriers are negatively charged.

For potentials greater than about 40 volts the percentage cathode activity is independent of the amount of emanation employed unless the amount be inordinately large; over the same range of potentials, moreover, it was verified that the ratio of the two ionization currents obtained for any two potentials was identical with the ratio of the corresponding

percentage cathode activities. The values obtained for the percentage cathode activity for air at 210 mm. pressure are greater than those obtained in the previous research. It is probable that this discrepancy is due to the fact that in the previous experiment some of the ebonite insulation was exposed to the emanation, so that the central electrode did not receive all the positive carriers. The insulation would probably act as a partial conductor, especially at the lower pressures when it would be exposed to the α radiation proceeding from a considerable distance. In the present experiment this source of error was carefully avoided, and the result appears to be that the same maximum value is obtained for the percentage cathode activity both for the lower and the higher pressure.

In the previous work the assumption was made that 100 per cent. was the limiting value which the cathode deposit approached as the potential was increased, and that even at the low pressures the saturation attained was merely apparent. This assumption was made chiefly as a result of the experimental observation that the percentage cathode activity was greater at the higher than the lower pressures. Since, however, it has now been shown that the percentage cathode activity has the same value (89.2) at the higher potentials for both pressures, it appears much better to regard this as the true limiting value. The gradual increase of the values for one atmosphere for potentials above 40 volts shows that the phenomenon of columnar recombination is present: the active deposit particle recoils into the gas after the expulsion of the α -particle from the atom of emanation and tends to recombine with the negative ions which it forms along its path.

Experiments made with a steel instead of a brass central electrode gave the same limiting value for the percentage cathode activity, indicating that this value does not depend upon the nature of the material of which the electrodes are composed.

At low pressures, as is well known, a considerable number of the active deposit particles may reach the walls of the containing vessel before their velocity is sufficiently reduced to enable them to be directed by the electric field. With air at a pressure of 6 mm. and with 180 volts the percentage cathode activity was found to be 66.7.

Experiments with Small Applied Potentials.

5. The experiments described in the preceding section refer to potentials for which the distribution of the active

deposit was independent of the amount of emanation employed. For smaller potentials the distribution depends considerably on the amount of emanation: this arises from the fact that with these potentials recombination can occur between the positive particles and negative ions which are produced in the volume of the gas, whereas for the larger potentials recombination can only occur to any appreciable extent with negative ions which are present in the same column as the active particle.

A number of experiments were performed to ascertain in what manner the cathode deposit depended upon the amount of emanation for any applied potential, and especially to see whether the distribution would vary in the same way as the ionization current which passed through the gas during the exposure.

In fig. 2 there are given two sets of curves which represent

Fig. 2.

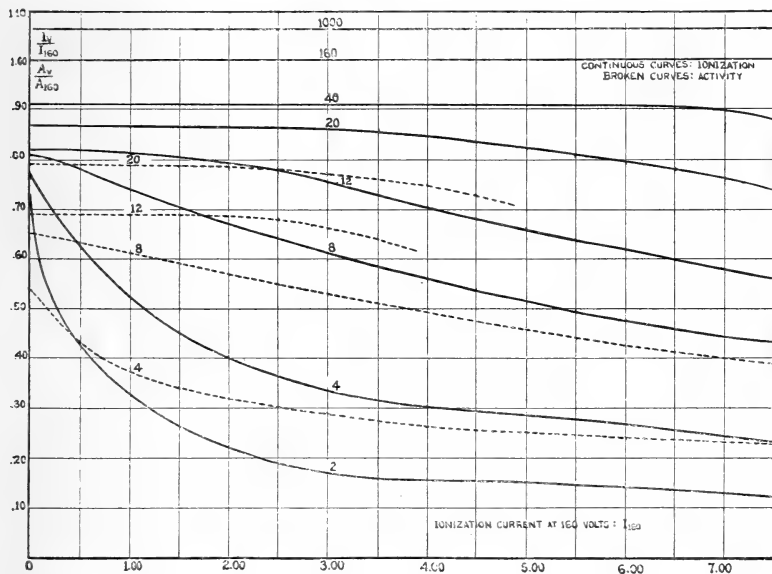

the results obtained in this series of experiments. The abscissæ represent the ionization current in scale-divisions per sec. (with added capacity) due to the emanation and active deposit in equilibrium when a positive potential of 160 volts was applied to the case. Inasmuch as this potential afforded the same percentage (viz. 94.3) of the saturation current whatever amount of emanation was employed,

the abscissæ (denoted by I_{160}) serve as a measure of the saturation current.

The continuous curves in fig. 2 have as ordinates I_V/I_{160} , *i. e.* the value of the current obtained with V volts applied to the case expressed as a fraction of the current obtained when 160 volts were applied.

The broken curves refer to the active deposit and have as ordinates A_V/A_{160} , *i. e.* the cathode deposit obtained with V volts applied to the case expressed as a fraction of the cathode deposit obtained when a positive potential of 160 volts was applied. As mentioned above, the cathode deposit obtained for a potential of 160 volts was only 83.9 per cent. of the total amount, and the maximum amount obtainable on the cathode for very large potentials was 89.2 per cent. of the total.

By plotting the curves in this manner the two sets become comparable; the continuous curves afford a measure of the fraction of the total number of positive ions which reach the cathode corresponding to any potential V , while the broken curves similarly afford a measure of the fraction of the total number of positively charged particles which settle on the cathode.

A very large number of experimental results were used in order to plot the curves; for the sake of simplification the individual results are not recorded in the diagram.

The curves in fig. 2 all refer to the values obtained when the air with which the emanation was mixed was thoroughly dried, as described in Section 4. The effect of a small amount of water vapour was especially marked when the applied potential was small. In illustration of this point some of the results obtained for dried and undried air are recorded below:—

Air at 1 atmosphere : {	A_V	I_V/I_{160}	I_{160}
$V=8$ volts	}			
dried with special caution.....		38.4	.61	3.21
containing slight traces of {	31.2	.61	3.21
water vapour	}			

It is worthy of notice that the presence of small quantities of water vapour does not appreciably diminish the fraction of positive ions which reach the cathode, whereas the effect on the number of positively charged deposit particles is considerable. It has for some time been known that water vapour is effective in causing increased recombination of ions, but the above results serve to show that the ions are not nearly so sensitive to the presence of vapour as the active deposit particles.

Referring again to the curves of fig. 2, it is seen that in general the "activity" curve for any given voltage lies below the ionization curve for the corresponding voltage. This is almost certainly to be ascribed to the increased recombination with negative ions which occurs with the active particles as compared with the positive ions, even when the air with which the emanation is mixed is thoroughly dried.

Cathode Deposit for very Small Quantities of Emanation in Dry Air.

6. If the curves in fig. 2 are produced so as to intersect the axis of ordinates, we obtain points which afford a measure of the fraction of ions and of positively charged deposit particles which would be obtained by the application of the corresponding potential when the air in the ionization vessel contains only a very small amount of emanation. These points are plotted both for ionization current and activity as separate curves in fig. 3; they may be regarded as limiting

Fig. 3.

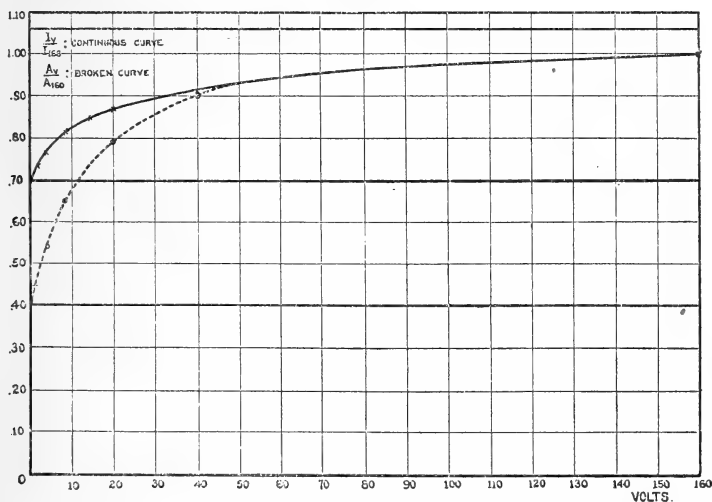

curves which correspond to the absence of volume recombination in the vessel even at the smallest potentials employed. The upward slope of the curves is due entirely to the fact that increasing potentials prevent more and more the recombination of the positive ions or particles with negative ions which are produced inside the α -particle column.

It will be seen from the curves that any given potential

brings over to the cathode a larger fraction of ions than of positively charged deposit particles; at a potential of about 40 volts the two curves practically coincide. The difference between the two curves can be explained by supposing that the negative ions which are produced in the column recombine with the positively charged active particles with greater facility than with the positive ions.

*Emanation mixed with Carbon Dioxide, Hydrogen,
and Ethyl Ether.*

7. When the emanation was mixed with dry CO_2 at various pressures, it was found that the maximum value obtained for the percentage cathode activity was 80.7. In order to obtain this value with potentials less than 1000 volts, the pressure had to be less than about 150 mm.

When the emanation was mixed with dry hydrogen the maximum value obtained for the percentage cathode activity was 89.2, the same as that obtained with air. This value could readily be obtained with a potential of 160 volts and with hydrogen at a pressure of 1 atmosphere, showing that there is very little columnar recombination in this gas. Hydrogen was found to be particularly sensitive to the presence of small traces of water vapour; the effect of the water vapour was to increase the potential necessary to obtain the same limiting value.

Inasmuch as the presence of minute quantities of water vapour resulted in a marked diminution of the amount of active deposit which settled on the cathode, it became of interest to ascertain the percentage of positively charged carriers which would result from mixing the emanation with a vapour. For this purpose ethyl ether was chosen; any gas which remained in the vessel was swept out by a stream of ether which had previously passed through P_2O_5 . The following results were obtained:—

Pressure.	Potential.	Percentage cathode activity.
mm.	volts	
82	160	6.4
85	1070	9.8
128	do.	10.0
235	do.	10.8

At the highest pressure there was a large current passing

through the vapour during the activation, due mainly to the fact that the ether being near the point of condensation was partly conducting; this conduction current may have been responsible for the increased amount of the cathode deposit at the highest pressure. Apart from this it appears that for ether vapour the limiting value of the cathode activity is approximately 10 per cent.

Summary and Discussion of Results.

8. When the emanation is mixed with any gas there appears to be a definite limit to the fraction of the active deposit which settles on the cathode. This limit is independent of the pressure of the gas provided it is high enough to prevent the deposit particles from recoiling on to the walls of the vessel; it is in general dependent on the nature of the gas. This limiting value is in general obtained only with large potentials; with smaller potentials the fraction of the cathode deposit is decreased as a result of columnar recombination of the positively charged particles with negative ions; and with very small potentials the charged particles recombine with negative ions in the volume of the gas. Small traces of water vapour have a considerable effect in diminishing the number of positively charged particles: the water vapour appears to be effective in bringing about increased recombination both volume and columnar between the charged particles and the negative ions.

It has been shown in Section 5 that even in air which has been thoroughly dried the recombination between the charged deposit particles and the negative ions is greater than the recombination between the positive and negative ions. This result, which is in all probability to be ascribed to the larger size and mass of the deposit particles, is not in accord with the experimental result of H. W. Schmidt*, who came to the conclusion that as far as recombination and mobility are concerned the active particles behave as positive ions.

The process which accompanies the deposit of the active particles on the cathode appears to be most suitably explained in the following manner. At the moment of expulsion of the α -particle from the atom of emanation the residual part recoils into the gas; in air at a pressure of 1 atmosphere the range of this recoil atom has been shown to be about $\frac{1}{10}$ mm. As it moves through the gas the recoil atom produces a large number of ions, and in the act of ionization it is possible that the recoil atom may lose its positive charge. On the other hand, recoil atoms which at any time are uncharged

* H. W. Schmidt, *Phys. Zeit.* ix. p. 184 (1908).

may regain a positive charge, so that if we consider a large number of recoil atoms there will at any given moment be a certain fraction which carry a positive charge, the remainder being practically all neutral. The process is in many respects similar to that which is known to occur in the case of canal rays. During the motion of recoil the atom is practically unaffected by any applied electric field, so that initially the relative number of uncharged and charged recoil atoms is independent of the applied potential. However, when the recoil atom has reached the end of its path, if it be positively charged it may lose its charge by recombination with a negative ion formed in the column; this recombination can be prevented by increasing sufficiently the applied potential. Moreover, for small applied potentials a positively charged recoil atom may recombine with a negative ion in the volume of the gas.

When both columnar and volume recombination are avoided by the application of a sufficiently high potential, the distribution of the active deposit on the electrodes is determined entirely by the relative number of charged and uncharged carriers resulting from the recoil of the atoms of RaA in the gas. Under these circumstances we should expect that the distribution would be independent of the pressure of the gas because the recoil atom will meet the same number of gas molecules before it is brought to relative rest. Of course, if the pressure is too low an appreciable number of active deposit particles will recoil on to the walls of the vessel, and in this manner the cathode deposit will be diminished.

Although nothing has been established in this research with regard to the velocity of the recoil atoms when moving under the influence of an electric field, nevertheless there is distinct evidence that, so far as diffusion and recombination are concerned, the recoil atoms behave differently from the positive gas ions. It has been shown in Section 5 that, when recombination occurs between negative ions on the one hand and positive ions or positive recoil atoms on the other hand, a considerably smaller fraction of recoil atoms than of positive ions is received by the negative electrode. This is especially the case with moist gases, but even in gases which had been dried with the utmost care the difference is well marked. An examination of the curves of fig. 3 seems to afford further information in this connexion. The curves may be regarded as giving the fraction either of positive ions or of positively charged recoil atoms that is received at the negative electrode for any given potential, volume recombination being supposed to be entirely absent. It will be

noticed that these curves cut the axis of ordinates at the points marked $\cdot 7$ and $\cdot 4$, these points representing respectively 66 per cent. of the total number of positive ions and 38 per cent. of the total number of positively charged deposit particles. This type of curve has already been treated by Wellisch and Woodrow* for the case of the columnar recombination resulting from α -particle ionization. It was shown by them that the ordinate of the point of intersection represents the fraction of the total number of ions which escapes from the α -particle column as a result of molecular agitation and diffusion. Inasmuch as volume recombination is absent, these ions are brought over to the electrodes by a very small electric field. If we draw through the point of intersection a straight line parallel to the axis of potential, and if we refer the curve to this straight line as a new axis of potential, then the new ordinates will indicate to what extent the electric potential is effective in preventing recombination between those ions which still remain in the column after the initial diffusion has occurred. If we treat the curves of fig. 3 in a similar manner we see that, whereas in the vessel employed 66 per cent. of the positive ions on the average escaped from the α -particle column, the corresponding figure for the positively charged recoil atoms was only 38 per cent. This slowness with which the recoil atoms diffuse is readily ascribable to their relatively large size and mass. Of those ions and recoil atoms which do not escape by diffusion from the column, approximately the same fraction is brought over by any given potential; it seems that there is here some compensating influence at work, probably the greater tendency of the recoil atoms to recombine with negative ions is partly balanced by the smaller number of encounters with these ions.

The existence of a definite limiting value to the percentage cathode activity has been ascribed above to a continual process of gain and loss of charge which occurs during the recoil motion of the active deposit particle. It is to be expected that this limiting value will depend upon the nature of the gas into which the particle recoils; the experimental determination showed that this was in general the case, although the limiting value for hydrogen was within the limits of error the same as that for air. The fact that the value for ether is as small as 10 per cent. is surprising, and is in all probability to be ascribed to the ease with which the molecules of ether are ionized.

* Wellisch and Woodrow, *Phil. Mag.* Sept. 1913.

LIII. *A Theory of Gravity.* By S. B. McLAREN, M.A.,
*Professor of Mathematics in University College, Reading**.

	Page
Introduction—The Principle of Relativity and the Theory of Riemann.—Summary	636
§ 1. Relativist Hydrodynamics	641
§ 2. Least Action in Electrodynamics	645
§ 3. Time and the Fourth Dimension	646
§ 4. Electrodynamics in Four Dimensions	649
§ 5. The Newtonian Potential a Velocity Potential	652
§ 6. Matter and Æther	655
§ 7. Energy, Momentum, and Stress	660
§ 8. Positive and Negative Charge, Magneton and Electron	667
§ 9. The Electromagnetic Equations in Moving Æther	668
§ 10. The Limits of Mechanical Theory	672

I DESIRE to call attention again to a theory of gravitation which goes back at least to Bernhard Riemann. For Riemann (*Ges. Math. Werke*, p. 529) “Æther” is a fluid and “Matter” a region where “Æther” is continually destroyed. Let us bring to the consideration of these ideas the most revolutionary principle Physicists have accepted since Riemann’s day, Einstein’s principle of the relativity of time.

With the starting point indicated by Riemann it is easy to account for Newton’s law of gravitation. Any piece of matter is an æther-sink and from all directions æther flows in to replace the æther destroyed. Given two finite portions of matter, it is evident that each disturbs the motion of æther towards the other. Thus Riemann’s line of argument is the same as that used in Lesage’s celebrated hypothesis, gravity is an effect of interference.

We may illustrate Riemann’s theory by considering the motion of any falling body, take in fact Newton’s legendary apple. When the apple begins to fall it is situated in a stream of æther flowing vertically downward. But it is quite misleading to suppose that the apple falls merely because it is carried down this stream, or that it is set in motion by an ordinary fluid pressure. In this paper at all events it is assumed that matter is something freely transferable through an æther which is present everywhere and so cannot press upon matter as upon a foreign substance. The downward momentum of the apple is appropriated from the æther destroyed, it is not transferred to the apple by a mechanical æther pressure. Indeed, if we regard matter as an æther-source instead of an æther-sink, the Newtonian law

* Communicated by the Author.

of attraction is not changed into a repulsion. The apple is now in an ascending stream of æther created by the earth. Into this stream it throws its own contributions. If there is still to be conservation of momentum the body falling must be driven downwards in the reaction against its own upward driven jet of æther. Repulsion between two pieces of matter could only arise if the one were a source and the other a sink.

Riemann's ideas attract by their simplicity and by the fundamental explanation of Newtonian attraction they offer. But they raise problems insoluble, it seems to me, by any methods less radical than those of the relativists. When gravity has been disposed of as due to mass motion of æther, what are we to say of optics? Perhaps we may be justified in treating æther as polarizable though fluid. Thus it may possess quasi-elastic properties, and these may account for waves of light. Then the problem for a follower of Riemann is to explain how the path of a ray of light and its velocity can remain unaltered by all motions of the medium through which light is transmitted. Even this incredible feat does not appear to be beyond the relativist.

In this paper I suggest the following conclusions. Let J be a function finite and continuous everywhere, as are its first differential coefficients. J satisfies the equation

$$\left(\nabla^2 - \frac{1}{c^2} \frac{d^2}{dt^2}\right) J + 4\pi m = 0, \dots \dots (36)$$

m is the absolute weight and is a constant the same for all matter. The force on an element of volume dv of matter is

$$mdv\nabla J \text{ or } mdvN, \dots \dots (39)$$

where N is the Newtonian gravitational force. Let ρ be the density of the æther and \mathbf{u} its velocity. The motion is irrotational in a sense appropriate to the theory of relativity (§ 1), and

$$\rho\mathbf{u} = \nabla J, \quad \rho c = -\frac{dJ}{cdt} \dots \dots (40)$$

Thus J is a velocity potential (§ 5). From (36) and (40)

$$\frac{d\rho}{dt} + \text{Div } \rho\mathbf{u} = -4\pi m.$$

Hence the quantity $4\pi m$ of æther disappears every second from unit volume occupied by matter.

It is not my present object to discuss the various possible

constitutions of matter. In § 6 I explain that which seems to me the simplest. According to this there is but one ultimate substance, a fluid whose density and motion are everywhere continuous. The substance has, however, two forms, "matter" and "æther," which are exclusive one of the other. Matter is a region where the fluid grows or decays. In this process the momentum of the æther "born" or "dying" is acquired from the surrounding æther, and all momentum is that of the one fluid substance. "Decay" or "growth" of æther involves, however, an extraneous source of energy, and the principle of conservation of energy is only a mathematical fiction preserved by attributing to matter an amount of energy equal per unit volume to

$$-mJ.$$

The equations of motion of the substance thus constituted are considered in § 6. It is shown that permanent irrotational motion of the type formulated in (40) is always possible.

In "æther" there is no growth or decay, but the fluid now possesses polar properties. These are defined by the electromagnetic vectors E and H , satisfying Maxwell's equations

$$\left. \begin{aligned} \frac{dE}{dt} = c \text{Curl } H, & \quad \frac{dH}{dt} = -c \text{Curl } E \\ \text{Div } E = 0, & \quad \text{Div } H = 0. \end{aligned} \right\}$$

At the boundary between "matter" and "æther" the ultimate substance passes freely from one form to the other, moving continuously in so doing. The conditions which determine the surface of transition are, firstly, that E and H behave as at a perfectly reflecting surface. And further

$$\frac{1}{8\pi} (E^2 - H^2) + mJ_0 = a - V_a. \quad \dots \quad (94)$$

a is here a constant and V_a is a potential function which vanishes in a purely mechanical theory (see § 10). The condition (94) is required to secure conservation of the energy and momentum (§ 7). J_0 in (94) is not identical with J , but differs from it by a term proportional to t the time.

$$J = J_0 - \rho_0 c^2 t. \quad \dots \quad (92)$$

ρ_0 is the density of the æther at infinity, J_0 is the Newtonian potential differing thus slightly from the velocity potential.

There is evidently much to query in this system. First, what is the dynamical nature of the fluid whose motion is determined by (40)? Relativist hydrodynamics suggest (§ 1) that we should deduce the laws of fluid motion from the minimum action formula

$$\delta \iiint L dv dt = 0, \quad \text{where } L = \frac{1}{2} \rho^2 (\mathbf{u}^2 - c^2).$$

In this fluid motion without circulation is represented by (40).

Granted that (40) may exist in an ideal fluid, how are we to ensure that the passage of a wave of light and the electromagnetic stresses do not disturb this type of motion, and, on the other hand, that the motion itself does not affect the form of Maxwell's equations? For according to (40) the density as well as the velocity of the æther vary from point to point.

I approach these problems in the first instance as a believer in the physical reality of a fourth dimension. I argue (§ 3) that the four-dimensional geometry of Minkowski is not a mathematical fiction, but a necessary inference from ordinary experience. Further, though as with Minkowski the four-dimensional universe is without change, it is not without time or motion. Time is not, however, here anything but a purely logical succession, the symbol of an order in which the elements of Minkowski's space are thought. The symbol τ which I use is the symbol of an infinitesimal point transformation (§ 3).

All the formulæ of our universe are deduced (§ 6) from the formula for the minimum action.

$$\delta \iiint L dv ds d\tau = 0, \quad (50)$$

$$L = \frac{1}{2} \left(\frac{d\mathbf{r}}{d\tau} \right)^2 - \frac{1}{2} \left(\frac{ds}{d\tau} \right)^2 + \frac{1}{8\pi} (\mathbf{H}^2 - \mathbf{E}^2) + V. \quad . . (51)$$

Here the vector \mathbf{r} and scalar s furnish four coordinates. The liquid substance is now (in four dimensions) incompressible; the volume element in (50)

$$dv ds$$

is not to vary at all in æther, and in matter it varies so as to grow or decay exponentially. Hence

$$\delta (dv ds e^{(4\pi)^{\frac{1}{2}} m \tau}) = 0. \quad (53)$$

I use the ordinary language of phenomenal time, and

speak of the motion and velocity of the four-dimensional liquid.

V in (51) is the potential of an external field of force (§ 10).

The electromagnetic energy in (51) is purely statical and produces in æther a force of amount

$$\frac{1}{8\pi} \nabla(H^2 - E^2)$$

per unit volume. This, without disturbing the irrotational motion, alters the distribution of pressure. The condition (94) is now shown to involve merely that the pressure of the liquid does not change in passing from æther to matter. The electromagnetic equations involve no trace of the æther's motion, because, since the energy is wholly statical, each particle of æther takes up without "lag" the polarization appropriate to the statical (four-dimensional) field of charge. The electromagnetic stresses must equilibrate with the reaction from each particle of æther against the polarizing apparatus attached to it. I show that these stresses give zero pressures and shears across the surface of matter. They differ from Maxwell's system of stresses owing to the action of the force

$$\frac{1}{8\pi} \nabla(E^2 - H^2),$$

which is the reaction to the force of translation on the fluid.

The physicist will naturally demand that this four-dimensional system should condescend to explain itself in the ordinary language of space and time. But if we are to have a moving æther, its properties are only capable of rational expression in the physicist's sense, if a system of time measurement is used relative to each of its particles. I show (§ 9) that the local æther time is simply proportional to the velocity potential J . In fact

$$t_a = -J/c^2. \quad \dots \quad (85)$$

Further, there is now a local density ρ_a given by

$$\rho_a = \rho(1 - u^2/c^2)^{\frac{1}{2}}. \quad \dots \quad (86)$$

Any given value of t_a defines a three-dimensional space which is Euclidean only in infinitesimal elements. The electromagnetic equations become

$$\left. \begin{aligned} \frac{d}{dt_a} (\rho_a E_a dS_a) &= c \text{Curl } H_a dS_a \\ \frac{d}{dt_a} (\rho_a H_a dS_a) &= -c \text{Curl } E_a dS_a \end{aligned} \right\} \dots \quad (91)$$

dS_a is an element of area moving with the æther. Thus (91) expresses that the specific inductive capacity and magnetic permeability of the æther are equal to each other and proportional to the density.

The results (36) and (40) were given by me in a paper read at the Mathematical Congress of 1912. The expressions for the energy and momentum to which they lead are the same as those given by Max Abraham. I had obtained them independently at the time when his work was published. In the paper referred to there is a result of the same character as (94), but differing from it because I there assume matter as a substance different from æther and having momentum of its own.

The results (91) are now first published. Before reading my former paper I had made attempts to find some such formulæ, but had failed to identify the local time at any point of the æther with the velocity potential.

The equations (91) may be interpreted to mean that in regions where ρ_a has different values the velocity of light varies inversely as ρ_a the density of the æther. The suggestion that the velocity of light may vary has already been made by Einstein and Abraham. Their ideas have not, so far as I am able to understand, much in common with these here maintained. The change of velocity is not an observable phenomenon, for all physical measure of time is a measurement by events, and the velocity of light is after all given only by the number of ticks the clock has made (§ 9). Stokes's theory of aberration also connects itself with ours. Taking the local time at any point of the æther the motion near that point is irrotational (§ 9) in the ordinary sense. In § 8 I suggest a physical basis for the distinction between negative and positive charges. If the electron is always the negative the magneton may always be the positive charge (§ 8).

The main results of this paper are in §§ 1, 3, 6, and (9).

§ 1. RELATIVIST HYDRODYNAMICS.

The principle of relativity assumed, what is the dynamical behaviour of a perfect fluid? As fluid its physical properties can depend only upon its density ρ and its velocity \mathbf{u} . In the formula of least action

$$\delta \iiint L dv dt = 0 \quad . \quad . \quad . \quad . \quad . \quad (1)$$

L is a function only of the values of ρ and \mathbf{u} at the volume element dv and at the time t . Also the principle of relativity

requires L to be an invariant under the Lorentz-Einstein substitution

$$\begin{aligned} ct_1 &= \beta(ct - \alpha x), \\ x_1 &= \beta(x - \alpha ct), \end{aligned} \quad \beta^2(1 - \alpha^2) = 1 \dots \dots \dots (A)$$

c being the velocity of light.

The simplest solution is to write

$$L = \frac{1}{2}\rho^2(\mathbf{u}^2 - c^2) \dots \dots \dots (2)$$

In varying the distribution of matter remember that

$$\delta(\rho dv) = 0 \dots \dots \dots (3)$$

The condition (3) is associated with the equation of continuity

$$\frac{d\rho}{dt} + \text{Div } \rho \mathbf{u} = 0 \dots \dots \dots (4)$$

The equations of motion are now deduced by the ordinary methods of the calculus of variations. They are

$$\frac{d}{dt'}(\rho^2 \mathbf{u} dv) + \nabla(\frac{1}{2}\rho^2 c^2 - \frac{1}{2}\rho^2 \mathbf{u}^2) dv = 0 \dots \dots (5)$$

Here

$$\frac{d}{dt'} = \frac{d}{dt} + \mathbf{u} \nabla,$$

so that $\frac{d}{dt'}$ denotes here and always the time rate of change at a moving point.

(4) is equivalent to

$$\frac{d}{dt'}(\rho dv) = 0 \dots \dots \dots (6)$$

Thus (5) becomes

$$\rho \frac{d}{dt'}(\rho \mathbf{u}) + \nabla(\frac{1}{2}\rho^2 c^2 - \frac{1}{2}\rho^2 \mathbf{u}^2) = 0 \dots \dots (7)$$

According to (5) the momentum per unit volume varies as

$$\rho^2 \mathbf{u},$$

the pressure varies as

$$\frac{1}{2}\rho^2(c^2 - \mathbf{u}^2).$$

Further, the energy is per unit volume

$$\frac{1}{2}(\rho^2 c^2 + \rho^2 \mathbf{u}^2).$$

For $\frac{d}{dt'}(\frac{1}{2}\rho^2 \mathbf{u}^2 dv + \frac{1}{2}\rho^2 c^2 dv)$

$$\begin{aligned} &= \rho \mathbf{u} \frac{d}{dt'}(\rho \mathbf{u}) dv + \rho c^2 \frac{d\rho}{dt'} dv + (\frac{1}{2}\rho^2 \mathbf{u}^2 + \frac{1}{2}\rho^2 c^2) \text{Div } \mathbf{u} \\ &= -\mathbf{u} \nabla(\frac{1}{2}\rho^2 c^2 - \frac{1}{2}\rho^2 \mathbf{u}^2) dv - \rho^2 c^2 \text{Div } \mathbf{u} dv + \frac{1}{2}(\rho^2 \mathbf{u}^2 + \frac{1}{2}\rho^2 c^2) \text{Div } \mathbf{u} dv \\ &= -\text{Div}\{\mathbf{u}(\frac{1}{2}\rho^2 c^2 - \frac{1}{2}\rho^2 \mathbf{u}^2)\} dv. \end{aligned}$$

Thus the energy increases by the amount of work done by the pressure on the element of volume dv .

I am not aware that these results of the principle of relativity are generally recognized. Most writers seem to begin with a material particle whose mass varies as

$$(1 - \mathbf{u}^2/c^2)^{-\frac{1}{2}},$$

and out of such particles construct a continuous fluid.

According to the relativist it appears that the momentum of a continuous fluid varies as the square of its density. It cannot be claimed that the results of experience contradict this view. It is true that in ordinary mechanical media the momentum is ordinarily assumed to vary as the density merely. But such media are not, if the atomic hypothesis is sound, continuous. The present theory would apply not to them but only within the atoms of which they are composed, provided we can imagine these to be formed by substance continuously distributed. And then it becomes in general impossible to decide on experimental grounds between the two rival expressions for the momentum

$$\rho \mathbf{u} \quad \text{and} \quad \rho^2 \mathbf{u}$$

since ρ the density within an atom is practically invariable. There is one exception. Kaufmann's experiments on the mass of the electron have been taken to indicate that there is a change of volume with very great velocities. And taken in this sense, Kaufmann's results are decisive in favour of the relativist's formula for the momentum.

For according to Kaufmann the mass of the electron varies as

$$(1 - \mathbf{u}^2/c^2)^{-\frac{1}{2}}.$$

Its volume varies on Lorentz's theory as

$$(1 - \mathbf{u}^2/c^2)^{\frac{1}{2}}.$$

Thus the mass per unit volume is proportional to

$$(1 - \mathbf{u}^2/c^2)^{-1},$$

or to the square of the density, taking the electron to be a continuous distribution of electric charge.

From (7) a vortex theory analogous to that of ordinary mechanics can easily be deduced. (7) may be written

$$\frac{d}{dt'}(\rho \mathbf{u}) + c^2 \nabla \rho - \mathbf{u} \nabla \rho \mathbf{u} = 0, \quad \quad (8)$$

{ $A_{\nabla} \mathbf{B}$ is the vector whose x component is

$$A_1 \frac{dB_1}{dx} + A_2 \frac{dB_2}{dx} + A_3 \frac{dB_3}{dx} \}.$$

Let $d\mathbf{r}$ be an element of length moving with the fluid

$$\frac{d}{dt'}(\rho\mathbf{u} d\mathbf{r}) = \frac{d}{dt'}(\rho\mathbf{u})d\mathbf{r} + \rho\mathbf{u} d\mathbf{u},$$

or
$$\frac{d}{dt'}(\rho\mathbf{u} d\mathbf{r}) = -c^2 d\rho + \mathbf{u}d(\rho\mathbf{u}) + \rho\mathbf{u} d\mathbf{u} \text{ (by 8).}$$

So
$$\frac{d}{dt'}(\rho\mathbf{u} d\mathbf{r}) = d(\rho\mathbf{u}^2 - \rho c^2). \quad \dots \dots \dots (9)$$

And if the integral be taken round any closed curve

$$\frac{d}{dt'} \left\{ \int \rho\mathbf{u} d\mathbf{r} \right\} = 0.$$

Thus if the integral expression

$$\int \rho\mathbf{u} d\mathbf{r}$$

is initially zero round all closed circuits, it remains permanently zero. In that case

$$\text{Curl } \rho\mathbf{u} = 0. \quad \dots \dots \dots (10)$$

But (8) may also be written

$$\frac{d}{dt}(\rho\mathbf{u}) + c^2 \nabla \rho - [\mathbf{u} \text{ Curl } \rho\mathbf{u}] = 0. \quad \dots \dots (11)$$

In case (10) holds (11) becomes

$$\frac{d}{dt}(\rho\mathbf{u}) + c^2 \nabla \rho = 0. \quad \dots \dots \dots (12)$$

And (10) and (12) are then equivalent to

$$\rho\mathbf{u} = \nabla J, \quad \rho c = -\frac{dJ}{cdt}. \quad \dots \dots \dots (13)$$

With the equation (4) of continuity (13) gives

$$\left(\nabla^2 - \frac{1}{c^2} \frac{d^2}{dt^2} \right) J = 0, \quad \dots \dots \dots (14)$$

and (13) may also be written

$$\int (\rho\mathbf{u} d\mathbf{r} - \rho c d\mathbf{r}) = 0. \quad \dots \dots \dots (15)$$

Any disturbance in the motion will according to (14) be propagated with the velocity of light.

§ 2. LEAST ACTION IN ELECTRODYNAMICS.

In the form given to electromagnetic theory by Lorentz matter and electricity are identified. *Æther* is merely the field of application of Maxwell's equations, and the only substance is electric fluid. I now assume that this electric fluid is of the type considered in last section. Every element of it is however subject not only to its own pressure but also to electric and magnetic forces. None the less a vortex theory analogous to that given in last section is still possible.

The formula for L the Lagrangian function is now

$$L = \frac{1}{8\pi} \left(-\frac{1}{c} \frac{dF}{dt} - \nabla\phi \right)^2 - \frac{1}{8\pi} (\text{Curl } F)^2 + \sigma(c^{-1}\mathbf{u}F - \phi) + \frac{1}{2}\epsilon\sigma^2(\mathbf{u}^2 - c^2), \quad (16)$$

σ is the density of the electric-fluid and satisfies the equation of continuity

$$\frac{d\sigma}{dt} + \text{Div}(\sigma\mathbf{u}) = 0. \quad (17)$$

The electric and magnetic intensities \mathbf{E} and \mathbf{H} are given by

$$\mathbf{E} = -\frac{1}{c} \frac{dF}{dt} - \nabla\phi, \quad \mathbf{H} = \text{Curl } F.$$

I find that (16), omitting the last term on the right, has already been used by Schwarzschild (see *Enc. der Math. Wiss.* Bd. v. Art. 14, S. 170). (16) is invariant under the Lorentz-Einstein substitution.

Maxwell's form for the Electromagnetic equations is reached by varying F and ϕ in (16),

$$\left. \begin{aligned} \left(\nabla^2 - \frac{1}{c^2} \frac{d^2}{dt^2} \right) F - \nabla \left(\text{Div } F + \frac{1}{c} \frac{d\phi}{dt} \right) + 4\pi c^{-1} \sigma \mathbf{u} &= 0, \\ \left(\nabla^2 - \frac{1}{c^2} \frac{d^2}{dt^2} \right) \phi + \frac{d}{cdt} \left(\text{Div } F + \frac{1}{c} \frac{d\phi}{dt} \right) + 4\pi \sigma &= 0. \end{aligned} \right\} \quad (18)$$

The Hertz-Heaviside formulæ are deduced from (18),

$$\left. \begin{aligned} \frac{d\mathbf{E}}{dt} + 4\pi\sigma\mathbf{u} &= c \text{Curl } \mathbf{H}, & \frac{d\mathbf{H}}{dt} &= -c \text{Curl } \mathbf{E} \\ \text{Div } \mathbf{E} &= 4\pi\sigma, & \text{Div } \mathbf{H} &= 0. \end{aligned} \right\} \quad (19)$$

If the distribution of electric charge is varied it can be shown that

$$\frac{d}{dt}(\epsilon\sigma^2\mathbf{u}dv) + \nabla\left(\frac{1}{2}\epsilon\sigma^2c^2 - \frac{1}{2}\epsilon\sigma^2\mathbf{u}^2\right)dv = \mathbf{E}'\sigma dv, \quad \dots \quad (20)$$

$$\mathbf{E}' = \mathbf{E} + c^{-1}[\mathbf{u}\mathbf{H}]. \quad \dots \quad (21)$$

Instead of (9) in last section we have now

$$\frac{d}{dt}\{\epsilon\sigma\mathbf{u} + c^{-1}\mathbf{F}\}d\mathbf{r} = d(\epsilon\sigma\mathbf{u}^2 - \epsilon\sigma c^2 + c^{-1}\mathbf{u}\mathbf{F} - \phi).$$

And an irrotational motion is possible such that

$$\epsilon\sigma\mathbf{u} + c^{-1}\mathbf{F} = \nabla\chi, \quad \epsilon\sigma c + c^{-1}\phi = -\frac{d\chi}{cdt}.$$

(18) now gives

$$\left. \begin{aligned} \left(\nabla^2 - \frac{1}{c^2}\frac{d^2}{dt^2} - \frac{4\pi}{\epsilon c^2}\right)\sigma\mathbf{u} &= 0, \\ \left(\nabla^2 - \frac{1}{c^2}\frac{d^2}{dt^2} - \frac{4\pi}{\epsilon c^2}\right)\sigma &= 0. \end{aligned} \right\}$$

The formula (16) for the action is only suitable when electricity is treated as a continuous fluid substance. Another treatment is given later in which the magnetic energy becomes kinetic energy in agreement with Larmor; in (16) we should be compelled to regard it as potential energy.

I shall show in §4 that a gravitational potential analogous to the electrostatic potential ϕ of (16) is reached by extending that formula to four dimensions. This procedure raises questions which I discuss in §3.

§ 3. TIME AND THE FOURTH DIMENSION.

All that we have already said and what is still to come can be made much clearer by using Minkowski's idea of the time variable, the t of ordinary physics, as the fourth co-ordinate of a four-dimensional space. It is far easier to think in four dimensions than in three.

Minkowski, it is well known, considered a timeless universe. What he speaks of as time is in reality only a length. I propose to go further. The universe is to be changeless but not timeless. All, matter and æther alike, is in motion, but it is the motion of the sleeping top or, rather, the waterfall. Æther and matter move in unvarying streams that never change their currents or their banks. Here there can be one absolute time throughout the universe, a time present to whatever consciousness sees the universe steadily

and sees it as a whole. Change is relative to us ignorant of the future, the distant, and almost all the past.

If a liquid moves in four dimensions the equation of continuity is evidently

$$\frac{dm}{d\tau} + \frac{d}{ds} \left(m \frac{ds}{d\tau} \right) + \text{Div} \left(m \frac{d\mathbf{r}}{d\tau} \right) = 0. \quad (22)$$

s is the fourth spatial coordinate and τ the absolute time. The vector notation is kept for three axes x, y, z . Where the motion is steady

$$\frac{dm}{d\tau} = 0.$$

Then (22) becomes

$$\frac{d}{ds} \left(m \frac{ds}{d\tau} \right) + \text{Div} \left(m \frac{d\mathbf{r}}{d\tau} \right) = 0. \quad (23)$$

Along any steady stream-line \mathbf{r} is a function of s . Thus if we put

$$m \frac{ds}{d\tau} = \rho a, \quad (24)$$

a being an arbitrary constant, (22) is replaced by

$$\frac{d}{ds} (\rho) + \text{Div} \left(\rho \frac{d\mathbf{r}}{ds} \right) = 0. \quad (25)$$

It is only necessary to write

$$s = ct \quad (26)$$

and (25) becomes the equation of continuity in the ordinary form, t now standing for the time.

The density ρ is by (24) proportional to the flux across a plane parallel to the s axis. Along any tube of constant flow the flux is the same whatever section of the tube be taken. Thus the invariance of electric charge in Lorentz's substitution is simply explained.

It may be objected that by retaining the idea of an absolute time I have sacrificed the essential feature of Minkowski's theory. That proposes to substitute for the time and space of our ordinary experience a universe of space alone. I, it appears, would have four dimensions in space and retain time as well. But if I assume the right to imagine a fourth dimension, why not a fifth and a sixth? What is the value of a theory which supplements the real world by such figments? These objections misrepresent my meaning. I deny that there is anything in my universe beyond what is given in immediate

experience and must be admitted by the purest empiricism. This I hope to argue at greater length elsewhere, here I must be content to assert dogmatically. The universe consists of "instants" or of that which has position in time and space. With Minkowski, therefore, we represent all reality as included in a four-dimensional manifold, which *is* time and space and is not therefore *in* time or space. But neither Minkowski nor any sane man wishes to deny the psychological distinction between space and time. When time is used in that sense it is evidently nonsense to resolve it into something else. What we do deny is the view that time and space are distinct physical objects. The only physical reality is the four dimensional manifold of space-time, where all the instants we become aware of in succession exist together.

Startling as Minkowski's procedure may appear, there seems no doubt that it is dictated by a very common-sense instinct. The least innovating of physicists will be loath to accept the view that time is a physical object as much as space and different from it. And Minkowski satisfies this instinctive feeling by resolving time into a fourth dimension plus what he can only perhaps describe as a psychological illusion, at all events not a real object for the physicist.

It is at this point we diverge from him. He too uses the symbol τ in (23), but defines it in terms of the spatial coordinates. With us it is an independent variable described as the "absolute time" of the unchanging universe. But here I use the word time to denote a logical order in thought, τ is the symbol of a continuous point transformation. If any instant a_2 is substituted for a_1 in this transformation, then there is a third instant a_3 which by the same process replaces a_2 , and a fourth instant a_4 succeeding to a_3 . Thus any transformation generates a continuous succession of instants, and this may be described as the motion of a material point a . As with Hegel matter becomes objectified thought, time incarnates a logical process.

Return again to time and space as we experience them, remembering that the ordinary time variable t is nothing but the fourth of the coordinates defining the position of any point in a certain four-dimensional space. How far then can it be said with significance that any instant is "before" or "after" any other instant.

As Robb has insisted ('Time and Space,' Cambridge, 1912), the only meaning to be attached to the statement "the instant P preceded Q" depends upon a theory of causation. It implies that a cause at P can produce an effect at Q. Now, no cause at P can influence any effect

at Q if the distance in three-dimensional space between P and Q is greater than light can travel in the interval of time between the two instants. This assumes the velocity of light to be the maximum physical velocity.

Let t_P and t_Q denote the times and \mathbf{r}_P and \mathbf{r}_Q the vector coordinates of P and Q. If

$$(\mathbf{r}_P - \mathbf{r}_Q)^2 - c^2(t_P - t_Q)^2 > 0, \dots \quad (\text{I.})$$

then P is neither "before" nor "after" Q.

If
$$(\mathbf{r}_P - \mathbf{r}_Q)^2 - c^2(t_P - t_Q)^2 < 0, \dots \quad (\text{II.})$$

then P is before or after Q according as t_Q is greater or less than t_P . The expression on the left of (I.) and (II.) is an invariant under the Lorentz-Einstein substitution.

Further, provided (II.) holds, the sign of $t_P - t_Q$ is unaltered by that substitution if we assume again that all velocities are less than that of light. When the relations "before" or "after" hold at all between two instants P and Q they are invariant relations.

The theory of relativity, so unjustly accused of abstractness and paradox, keeps with unswerving fidelity to the safe path of experience and common-sense.

§ 4. ELECTRODYNAMICS IN FOUR DIMENSIONS.

I propose now to extend to four dimensions the formulæ (16) and (1).

$$\delta \iiint \iiint L_1 dv_1 ds_1 d\tau_1 = 0 \dots \dots \dots (27)$$

$$\left. \begin{aligned} L_1 = & (8\pi)^{-1} \left(\frac{dF_1}{ad\tau_1} + \nabla \cdot J_1 \right)^2 + (8\pi)^{-1} \left(\frac{d\phi_1}{ad\tau_1} + \frac{dJ_1}{ds_1} \right)^2 \\ & - (8\pi)^{-1} \left(\frac{dF_1}{ds_1} - \nabla \phi_1 \right)^2 - (8\pi)^{-1} (\text{Curl } F_1)^2 \\ & + m_1 a^{-1} \left(\frac{d\mathbf{r}_1}{d\tau_1} F_1 + \frac{ds_1}{d\tau_1} \phi_1 - a J_1 \right) \\ & + \frac{1}{2} k^2 m_1^2 \left\{ \left(\frac{d\mathbf{r}_1}{d\tau_1} \right)^2 + \left(\frac{ds_1}{d\tau_1} \right)^2 - a^2 \right\}. \end{aligned} \right\} \dots \quad (28)$$

Here the spatial coordinates are x_1, y_1, z_1, s_1 , and the time is τ_1 . I have reserved the vector notation for three dimensions.

There is in (28) a vector whose components are F, ϕ_1 and a scalar J_1 . It will be noticed that all four coordinates enter into (28) on exactly the same terms; the space is in fact

Euclidean. m_1 represents the density of a fluid-substance

$$\text{and } \frac{dm_1}{d\tau_1} + \text{Div} \left(m_1 \frac{d\mathbf{r}_1}{d\tau_1} \right) + \frac{d}{ds_1} \left(m_1 \frac{ds_1}{d\tau_1} \right) = 0 \dots \dots (29)$$

Let (27) and (28) be transformed by the substitution

$$\left. \begin{aligned} a\tau &= \beta_1(a\tau_1 - \alpha_1 s_1), & \beta_1^2(\alpha_1^2 - 1) &= 1, \\ s &= \beta_1(s_1 - \alpha_1 a\tau_1), & \alpha_1 &> 1, \\ \mathbf{r} &= \mathbf{r}_1, & am &= \beta_1 \left(am_1 - \alpha_1 m_1 \frac{ds_1}{d\tau_1} \right). \end{aligned} \right\} \dots \dots (B)$$

This substitution corresponds to a reference to axes moving with the velocity $a\alpha_1$ greater than a the quantity which in (28) plays the same part as c , the velocity of light in three dimensions. It is referred to these axes that I suppose the state steady. Then (29) becomes (23). For (27) there is to be substituted

$$\delta \iiint \iiint L \, dv \, ds \, d\tau = 0 \dots \dots \dots (30)$$

L_1 transforms into L and it will be enough to retain only those terms found in a steady state.

$$\begin{aligned} L &= -(\delta\pi)^{-1}(\nabla J)^2 + (\delta\pi)^{-1} \left(\frac{dJ}{ds} \right)^2 + mJ \\ &+ (\delta\pi)^{-1} \left(\frac{d\mathbf{F}}{ds} + \nabla\phi \right)^2 - (\delta\pi)^{-1} (\text{Curl } \mathbf{F})^2 \\ &+ ma^{-1} \left(\frac{d\mathbf{r}}{d\tau} \mathbf{F} - \frac{ds}{d\tau} \phi \right) + \frac{1}{2} k^2 m^2 \left\{ \left(\frac{d\mathbf{r}}{d\tau} \right)^2 - \left(\frac{ds}{d\tau} \right)^2 + a^2 \right\}. \end{aligned} \quad (31)$$

In (31) s no longer enters on the same terms as the other coordinates. s is in fact the time variable of ordinary physics. We have only to replace t by using (26). In (31) all terms containing \mathbf{F} and ϕ become identical with the terms of (16).

We have merely to write as in (24)

$$m \frac{ds}{d\tau} = \sigma a \dots \dots \dots (32)$$

and the equation of continuity (23) into which (29) transforms finally becomes (17).

I shall suppose that m is an absolute constant, so that the electric fluid is incompressible in four dimensions. Then the variations in (30) are restricted by

$$\delta(dv \, ds) = 0 \dots \dots \dots (33)$$

(33) introduces therefore a liquid pressure p_m into the

four-dimensional equations of fluid motion. This is done by writing on the left of (30) the expression

$$\iiint p_m \left(\text{Div } \delta r + \frac{d}{ds} \delta s \right) dv ds d\tau.$$

We have then the following four-dimensional equations of motion :

$$\left. \begin{aligned} k^2 m^2 \frac{d}{d\tau'} \left(\frac{d\mathbf{r}}{d\tau} \right) + a^{-1} m \frac{dF}{d\tau'} - a^{-1} m \left(\frac{d\mathbf{r}}{d\tau} \nabla F - \frac{ds}{d\tau} \nabla \phi + a \nabla J \right) + \nabla p_m &= 0, \\ k^2 m^2 \frac{d}{d\tau'} \left(-\frac{ds}{d\tau} \right) - a^{-1} m \frac{d\phi}{d\tau'} - a^{-1} m \left(\frac{d\mathbf{r}}{d\tau} \frac{dF}{ds} - \frac{ds}{d\tau} \frac{d\phi}{ds} + a \frac{dJ}{ds} \right) + \frac{dp_m}{ds} &= 0, \\ \frac{d}{d\tau'} &= \frac{d\mathbf{r}}{d\tau} \nabla + \frac{ds}{d\tau} \frac{d}{ds}. \end{aligned} \right\} \quad (34)$$

Now, just as in the three dimensions of § 2, so it may be shown here that for any complete circuit

$$\frac{d}{d\tau'} \left\{ \left(k^2 m^2 \frac{d\mathbf{r}}{d\tau} + a^{-1} m F \right) d\mathbf{r} - \left(k^2 m^2 \frac{ds}{d\tau} + a^{-1} m \phi \right) ds \right\} = 0.$$

So that the circulation round any four-dimensional circuit remains constant. We are concerned, however, with a motion steady in four dimensions and wish to determine under what conditions it may be irrotational. From (34) it can be deduced that in any steady motion whatever the quantity

$$p_m + \frac{1}{2} k^2 m^2 \left\{ \left(\frac{d\mathbf{r}}{d\tau} \right)^2 - \left(\frac{ds}{d\tau} \right)^2 \right\} - mJ$$

is a constant along any one stream-line. This is quite analogous to corresponding results in ordinary hydrodynamics. If the motion is irrotational the above quantity is an absolute constant everywhere,

$$p_m + \frac{1}{2} k^2 m^2 \left\{ \left(\frac{d\mathbf{r}}{d\tau} \right)^2 - \left(\frac{ds}{d\tau} \right)^2 \right\} - mJ = -k_m \quad . \quad . \quad (35)$$

If in (34) the value of p_m is substituted and if, to correspond with § 2, we write

$$k^2 a^2 = \epsilon c^2,$$

then it can easily be shown that the first three equations (34) become identical with (20). The last equation (34) is now

$$\epsilon \sigma \mathbf{u} \left(\frac{d}{dt} \sigma \mathbf{u} + \nabla \sigma c \right) = \sigma \mathbf{u} E.$$

This is simply the equation of energy in three dimensions, and is deducible from the others. Thus all the equations of motion return to their three dimensional forms. The electromagnetic equations are unaltered. Finally, variation of J in (31) gives

$$\left(\nabla^2 - \frac{1}{c^2} \frac{d^2}{dt^2}\right)J + 4\pi m = 0. \quad (36)$$

J can be recognized as the Newtonian potential. The only equation in which the fourth-dimension finally intrudes is (35). This may be written

$$\frac{1}{2}\epsilon\sigma^2(c^2 - \mathbf{u}^2) = k_m - mJ + p_m. \quad (37)$$

Now at the surface p_m is zero. Hence (35) becomes

$$\frac{1}{2}\epsilon\sigma^2(c^2 - \mathbf{u}^2) = k_m - mJ, \quad (38)$$

and if the left-hand side of (38) is regarded as the fluid pressure, then at the surface there seem to be the applied pressure k_m and the applied tension mJ . The latter is equivalent (taking m to be an absolute constant) to the gravitational volume force

$$mdv\nabla J \quad (39)$$

and the absolute weight of all matter is the same per unit volume. The applied pressure postulated by Poincaré is the pressure k_m .

§5. THE NEWTONIAN POTENTIAL A VELOCITY POTENTIAL.

The theory of gravitation given in last section is purely formal. By bringing in a fourth dimension Maxwell's scalar potential ϕ is replaced by a scalar potential J . Maxwell's F and ϕ become the four components of a single vector. It is now possible to introduce Riemann's idea of a fluid æther. In (31) the terms containing differentials of J are just those arising in the irrotational motion of such a fluid as that of § 1 when subject to no external forces. If we write as in (13)

$$\left. \begin{aligned} \nabla J = \rho \mathbf{u} &= (4\pi)^{\frac{1}{2}} \frac{d\mathbf{x}_a}{d\tau} \\ -\frac{dJ}{ds} = \rho c &= (4\pi)^{\frac{1}{2}} \frac{ds_a}{d\tau} \end{aligned} \right\} \dots \dots \dots (40)$$

then (36), if m is zero, can be interpreted as the equation of continuity just as (14) in § 1.

Where m is not zero (36) gives

$$\frac{d\rho}{dt} + \text{Div } \rho \mathbf{u} = -4\pi m. \quad \dots \dots \dots (41)$$

or

$$\frac{d}{ds} \left(\frac{ds_a}{d\tau} \right) + \text{Div} \left(\frac{dr_a}{d\tau} \right) = -(4\pi)^{\frac{1}{2}} m. \quad \dots \dots \dots (42)$$

(41) shows that the quantity $4\pi m$ of æther disappears per second and per unit volume, and (42) written in the form

$$\frac{d}{d\tau'} (dv_a ds_a) = -(4\pi)^{\frac{1}{2}} m dv_a ds_a$$

shows that the quantity

$$dv_a ds_a \times e^{(4\pi)^{\frac{1}{2}} m \tau'} \quad \dots \dots \dots (43)$$

is a constant. The volume of any given element of æther decays where matter is present.

When, as in this section, matter is treated as a substance distinct from æther, the momentum of the æther destroyed is handed over to matter, and this is the origin of gravitational force. We have to consider how that can be done without interference with the irrotational æther-flow. We may imagine that each element of æther removed drops out without interfering with the rest. The principle of minimum action may then be modified in the manner expressed by the formulæ (44) to (46),

$$\begin{aligned} & \delta \iiint L_a dv_a ds_a d\tau + \delta \iiint L_m dv_m ds_m d\tau \\ & + m(4\pi)^{\frac{1}{2}} \iiint \left(\frac{dr_a}{d\tau} \delta r_a - \frac{ds_a}{d\tau} \delta s_a \right) dv_a ds_a d\tau \\ & + m(4\pi)^{\frac{1}{2}} \iiint \left(\frac{dr_m}{d\tau} \delta r_m - \frac{ds_m}{d\tau} \delta s_m \right) dv_m ds_m d\tau = 0 \quad \dots \quad (44) \end{aligned}$$

$$L_a = -\frac{1}{2} \left(\frac{dr_a}{d\tau} \right)^2 + \frac{1}{2} \left(\frac{ds_a}{d\tau} \right)^2 + \frac{1}{8\pi} (E^2 - H^2) \quad \dots \dots \dots (45)$$

$$L_m = ma^{-1} \left(\frac{dr_m}{d\tau} F - \frac{ds_m}{d\tau} \phi \right) + \frac{1}{2} k^2 m^2 \left\{ \left(\frac{dr_m}{d\tau} \right)^2 - \left(\frac{ds_m}{d\tau} \right)^2 \right\} \quad (46)$$

The function L_a exists wherever there is æther, L_m only where there is matter. In applying (44) we must remember that the variations are subject not only to

$$\delta (dv_m ds_m) = 0,$$

but also by (43) as long as the time τ is not varied to

$$\delta (dv_a ds_a) = 0.$$

These conditions introduce an æther-pressure as well as a pressure in matter.

When the motion of the æther is varied, it may be shown that

$$\left. \begin{aligned} \frac{d}{d\tau_a} \left(\frac{d\mathbf{r}}{d\tau} dv_a ds_a \right) &= -\nabla \left(p_a + \frac{1}{8\pi} \mathbf{E}^2 - \frac{1}{8\pi} \mathbf{H}^2 \right) dv_a ds_a \\ &\quad - m(4\pi)^{\frac{1}{2}} \frac{d\mathbf{r}_a}{d\tau} dv_a ds_a, \\ \frac{d}{d\tau_a} \left(-\frac{ds_a}{d\tau} dv_a ds_a \right) &= -\frac{d}{ds} \left(p_a + \frac{1}{8\pi} \mathbf{E}^2 - \frac{1}{8\pi} \mathbf{H}^2 \right) dv_a ds_a \\ &\quad + m(4\pi)^{\frac{1}{2}} \frac{ds_a}{d\tau} dv_a ds_a. \end{aligned} \right\} \quad (47)$$

The equations (47) indicate that the transfer of momentum is effected by an æther-pressure p_a , and that a force on æther

$$\frac{1}{8\pi} \nabla (\mathbf{H}^2 - \mathbf{E}^2)$$

acts per unit volume. The last terms on the right of the equations (47) correspond simply to the rate of loss of momentum due to the æther which has dropped out, they are in form equivalent to a frictional force proportional to the velocity. By (42) there disappears the amount of æther

$$(4\pi)^{\frac{1}{2}} m dv_a ds_a,$$

per unit time taking with it the momentum

$$(4\pi)^{\frac{1}{2}} m \frac{d\mathbf{r}_a}{d\tau} dv_a ds_a$$

which appears on the right of (47).

Remembering (42) write (47)

$$\left. \begin{aligned} \frac{d}{d\tau} \left(\frac{d\mathbf{r}_a}{d\tau} \right) &= -\nabla \left(p_a + \frac{1}{8\pi} \mathbf{E}^2 - \frac{1}{8\pi} \mathbf{H}^2 \right) \\ \frac{d}{d\tau} \left(-\frac{ds_a}{d\tau} \right) &= -\frac{d}{ds} \left(p_a + \frac{1}{8\pi} \mathbf{E}^2 - \frac{1}{8\pi} \mathbf{H}^2 \right) \end{aligned} \right\} \quad (48)$$

And now (48) leads to conclusions of the same kind concerning vortex-motion and pressure as we deduced for the motion of matter from (34). Instead of (35) we have now

$$p_a + \frac{1}{8\pi} \mathbf{E}^2 - \frac{1}{8\pi} \mathbf{H}^2 + \frac{1}{2} \left(\frac{d\mathbf{r}_a}{d\tau} \right)^2 - \frac{1}{2} \left(\frac{ds_a}{d\tau} \right)^2 = -k_a. \quad (49)$$

And the irrotational motion given by (40) is possible even when matter is present. Nothing in the deductions from (48) requires the equation of continuity, and on restoring J the formula (44) becomes equivalent to (30).

Variation of F and ϕ in (44) leads to the electromagnetic equations as before. These are unaffected by the motion of æther. If we are willing to accept a four-dimensional space as physically real, and it seems to me that this is almost inevitable, the explanation is easy. Each element of æther is capable of a polarization defined by ϕ and the components of F . The polarization can be varied without varying the æther's motion, and the energy arising hence is wholly statical. It is determined entirely by the position occupied in the statical universe by charged matter. And each element of æther as it moves takes up without "lag" the appropriate polarization of this statical field.

The electromagnetic field causes, however, a volume force of amount

$$\frac{1}{8\pi} \nabla(H^2 - E^2)$$

in the æther, which merely alters its pressure without affecting the irrotational flow.

All this will hardly satisfy physicists who still regard a fourth dimension as merely a mathematician's dream. I have therefore discussed again in § 9 how the theory of a moving æther can be reconciled with the facts of optics. It is then necessary to interpret the electromagnetic equations in terms of the local time at any point of the æther. The results may placate those who are more at ease in three dimensions than in four.

§ 6. MATTER AND ÆTHER.

My main concern is with the law of gravity; it is not my purpose to discuss here the various hypotheses which may be adopted as to the nature of matter. The essential point of my theory is that matter, whatever else it may be, is an æther-sink—or an æther-source. Thus I have so far borne in mind that we may wish to treat matter as a distinct substance, the electric fluid. But a much more radical treatment is possible. We need no longer suppose that there are two distinct substances, æther and matter. I shall now postulate that there is but one substance, a fluid whose density, motion, and pressure are everywhere continuous.

In "æther" this fluid is polarized, in "matter" it is

destroyed or created. The one state excludes the other, and at the frontiers of the regions occupied by matter and æther the fluid passes from one state to the other. When matter is regarded as a sink it is understood that the momentum of the substance removed at any point is added to that which remains.

The whole body of formulæ used will be strictly deduced from the principle of least action

$$\delta \iiint L dv ds dt = 0 \dots \dots (50)$$

$$L = \frac{1}{2} \left(\frac{dx}{dt} \right)^2 - \frac{1}{2} \left(\frac{ds}{dt} \right)^2 + \frac{1}{8\pi} (H^2 - E^2) - V \dots \dots (51)$$

V here denotes potential energy. I shall have more to say of it later.

The quantities E and H are connected by the relations

$$\text{Div } E = 0, \quad \frac{dE}{ds} = \text{Curl } H \dots \dots (52)$$

These are to be treated as "geometrical restraints." H and E exist only in "æther." The equation of continuity requires as in last section

$$\delta \left(dv ds e^{(4\pi)^{\frac{1}{2}} m \tau'} \right) = 0, \dots \dots (53)$$

where m is zero in æther and a constant different from zero in matter. Thus so long as the time τ' is not varied

$$\delta (dv ds) = 0 \dots \dots (54)$$

In applying (50) let E and H first be varied leaving undisturbed the boundaries of matter and æther and their motion.

Then (50) and (51) give

$$\iiint (H \delta H - E \delta E) dv ds d\tau = 0, \dots \dots (55)$$

under the conditions that

$$\text{Div } \delta E = 0 \quad \text{and} \quad \frac{d}{ds} \delta E = \text{Curl } \delta H \dots \dots (56)$$

Further, the equation

$$\frac{dE}{ds} = \text{Curl } H$$

shows that

$$\frac{d}{ds} \iint E dS = 0,$$

where dS is an element of area of any closed material

surface in a region where s has any given value. Thus for any such surface the value of the induction

$$\iint E dS$$

is a constant. I assume that this constant is not to be varied.

Hence
$$\iint \delta E dS = 0.$$

This condition and the equations (56) are satisfied by

$$\delta E = \text{Curl } \delta A, \quad \delta H = \frac{d}{ds} \delta A + \nabla \delta \omega.$$

Here δA and $\delta \omega$ are any continuous functions.

I shall confine myself to steady four-dimensional states. (55) may now be written

$$\iiint \left\{ H \left(\frac{d}{ds} \delta A + \nabla \delta \omega \right) - E \text{Curl } \delta A \right\} dv ds d\tau = 0.$$

Omitting the time element $d\tau$, this last is equivalent to

$$\begin{aligned} & \iiint \left\{ \frac{d}{ds} (H \delta A) + \nabla (\delta \omega H - [\delta A E]) \right\} dv ds \\ & - \iiint \left\{ \delta A \left(\frac{dH}{ds} + \text{Curl } E \right) + \delta \omega \text{Div } H \right\} dv ds. \quad (57) \end{aligned}$$

Hence
$$\frac{dH}{ds} = - \text{Curl } E, \quad \text{Div } H = 0. \quad (58)$$

And (57) reduces to

$$\iiint \left\{ \frac{d}{ds} (H \delta A) + \nabla (\delta \omega H - [\delta A E]) \right\} dv ds = 0. \quad (59)$$

Remembering (26) the equations (52) and (58) are seen to be the electromagnetic equations (59) will give the surface conditions. It will be convenient to give it a three-dimensional form. That is

$$\iiint \left\{ \frac{d}{cdt} (H \delta A) + \nabla (d\omega H - [\delta A E]) \right\} dv dt = 0.$$

The integration with respect to the time has as its upper limit the moment when the surface of matter crosses the volume dv . If U_n is the normal velocity of the surface element dS , then (59) becomes

$$\iiint \{ c^{-1} U_n H \delta A - \delta \omega n H + n [\delta A E] \} dS dt = 0. \quad (60)$$

n is a unit vector drawn outwards normally from the surface of matter.

(60) gives by equating to zero the coefficient of $\delta\omega$,

$$\mathbf{uH} = 0 ;$$

or the normal component of \mathbf{H} is zero. The same condition recurs on equating to zero the coefficient of the normal component of $\delta\mathbf{A}$. And (60) then gives that the tangential components of

$$\mathbf{E} + c^{-1} [\mathbf{uH}]$$

are zero, where \mathbf{u} is any velocity whose component normal to the surface is the same as the normal velocity of the surface itself. The conditions thus determined are just those which hold at a perfect reflector.

In assuming (52) as the conditions under which the Electromagnetic Lagrangian function is

$$\frac{1}{8\pi} (\mathbf{H}^2 - \mathbf{E}^2)$$

we are following Larmor ('Æther and Matter'). This procedure makes the magnetic energy kinetic in ordinary space.

I now deduce the equations of motion in matter and in æther by variation. I shall assume that the variation considered begins and ends either in matter or in æther, and that τ is not varied. I shall distinguish matter and æther by suffixes.

The equations of motion are

$$\left. \begin{aligned} \frac{d}{d\tau'} \left(\frac{d\mathbf{r}}{d\tau} dv ds \right) + \nabla \left(p + \frac{1}{8\pi} \mathbf{E}^2 - \frac{1}{8\pi} \mathbf{H}^2 + V \right) dv ds = 0, \\ \frac{d}{d\tau'} \left(-\frac{ds}{d\tau} dv ds \right) + \frac{d}{ds} \left(p + \frac{1}{8\pi} \mathbf{E}^2 - \frac{1}{8\pi} \mathbf{H}^2 + V \right) dv ds = 0 \end{aligned} \right\} . \quad (61)$$

Remembering that

$$\frac{d}{d\tau'} (dv ds) = -(4\pi)^{\frac{1}{2}} m dv ds$$

(61) reduces to

$$\left. \begin{aligned} \frac{d}{d\tau'} \left(\frac{d\mathbf{r}}{d\tau} \right) - (4\pi)^{\frac{1}{2}} m \frac{d\mathbf{r}}{d\tau} + \nabla \left(p + \frac{1}{8\pi} \mathbf{E}^2 - \frac{1}{8\pi} \mathbf{H}^2 + V \right) = 0, \\ \frac{d}{d\tau'} \left(-\frac{ds}{d\tau} \right) + (4\pi)^{\frac{1}{2}} m \frac{ds}{d\tau} + \frac{d}{ds} \left(p + \frac{1}{8\pi} \mathbf{E}^2 - \frac{1}{8\pi} \mathbf{H}^2 + V \right) = 0 \end{aligned} \right\} . \quad (62)$$

Consider the "circulation." It is easily proved that

$$\frac{d}{d\tau'} \left(\frac{d\mathbf{r}}{d\tau} d\mathbf{r} - \frac{ds}{d\tau} ds \right) = (4\pi)^{\frac{1}{2}} m \left(\frac{d\mathbf{r}}{d\tau} d\mathbf{r} - \frac{ds}{d\tau} ds \right) - dp' \quad (63)$$

$$p' = p + \frac{1}{8\pi} (E^2 - H^2) + \frac{1}{2} \left(\frac{d\mathbf{r}}{d\tau} \right)^2 - \frac{1}{2} \left(\frac{ds}{d\tau} \right)^2 + V. \quad (64)$$

Thus if we take any complete circuit in matter or in æther the circulation satisfies the equation

$$\frac{d}{d\tau'} \int \left\{ \frac{d\mathbf{r}}{d\tau} d\mathbf{r} - \frac{ds}{d\tau} ds \right\} = (4\pi)^{\frac{1}{2}} m \int \left(\frac{d\mathbf{r}}{d\tau} d\mathbf{r} - \frac{ds}{d\tau} ds \right),$$

and if the circulation vanishes initially round any circuit it remains always zero.

We are it is true concerned only with steady motion. This result suggests, however, that we should investigate the conditions under which an irrotational steady motion is possible.

As in (40) we are to have

$$(4\pi)^{\frac{1}{2}} \frac{d\mathbf{r}}{d\tau} = \nabla J, \quad (4\pi)^{\frac{1}{2}} \frac{ds}{d\tau} = -\frac{dJ}{ds} \quad (40 \text{ bis})$$

It is easily shown that the equations (62) are all satisfied if both in matter and in æther the quantity

$$p + \frac{1}{8\pi} (E^2 - H^2) + \frac{1}{2} \left(\frac{d\mathbf{r}}{d\tau} \right)^2 - \frac{1}{2} \left(\frac{ds}{d\tau} \right)^2 - mJ + V$$

is a constant. It is not shown that this constant is the same in matter and æther.

Hence I write

$$p_a + \frac{1}{8\pi} (E^2 - H^2) + \frac{1}{2} \left(\frac{d\mathbf{r}_a}{d\tau} \right)^2 - \frac{1}{2} \left(\frac{ds_a}{d\tau} \right)^2 + V_a = c_a \quad (65)$$

$$p_m + \frac{1}{2} \left(\frac{d\mathbf{r}_m}{d\tau} \right)^2 - \frac{1}{2} \left(\frac{ds_m}{d\tau} \right)^2 - mJ + V_m = c_m. \quad (66)$$

The last type of variation to be considered is that in which the boundaries between matter and æther are altered. I shall confine myself to variations in which (40) holds and the state is steady. The variation consists in the fact that a volume element

$$\delta(dv ds)$$

is transferred from æther to matter.

Using (40) in (51) we are to find the condition that (50) should hold

$$\delta \iiint \left\{ \frac{1}{8\pi} (\nabla J)^2 - \frac{1}{8\pi} \left(\frac{dJ}{ds} \right)^2 + \frac{1}{8\pi} (\mathbf{H}^2 - \mathbf{E}^2) - V \right\} dv ds = 0.$$

Hence we have

$$\begin{aligned} & \frac{1}{4\pi} \iiint \left(\nabla J \nabla \delta J - \frac{dJ}{ds} \frac{d}{ds} \delta J \right) dv ds \\ & - \iiint \left(\frac{1}{8\pi} \mathbf{H}^2 - \frac{1}{8\pi} \mathbf{E}^2 - V_a + V_m \right) \delta (dv ds) = 0. \end{aligned} \quad (67)$$

The values of V_a and V_m may not be continuous at the surface.

Now J and δJ being continuous as well as their first differentials, (67) can be written by partial integration

$$\frac{1}{4\pi} \iiint J \left(\nabla^2 - \frac{d^2}{ds^2} \right) \delta J dv ds + \iiint \left(\frac{1}{8\pi} \mathbf{H}^2 - \frac{1}{8\pi} \mathbf{E}^2 - V_a + V_m \right) \delta dv ds \quad (68)$$

$$\text{But} \quad \left(\nabla^2 - \frac{d^2}{ds^2} \right) \delta J + 4\pi \delta m = 0.$$

The variation δm is finite—from zero to m —and $\delta m dv ds$ is $m \delta (dv ds)$.

So (68) gives finally

$$\iiint \left(\frac{1}{8\pi} \mathbf{H}^2 - \frac{1}{8\pi} \mathbf{E}^2 - V_a + V_m - mJ \right) \delta dv ds = 0.$$

Hence

$$\frac{1}{8\pi} \mathbf{H}^2 - \frac{1}{8\pi} \mathbf{E}^2 - V_a + V_m - mJ = 0. \quad (69)$$

(69) used in (65) and (66) shows that

$$p_a - p_m = c_a - c_m.$$

Without loss of generality the pressures p_a and p_m may be made equal and c_a equal to c_m .

§ 7. ENERGY, MOMENTUM, AND STRESS.

Independently of Max Abraham ("Sulla Teoria della Gravitazione" *Atti della R. Acc. dei Lincei*), I had reached (in 1911) results equivalent to his for the energy and momentum of the gravitational field. Writing after Abraham it is now unnecessary for me to do more than merely to state the most important formulæ.

The electromagnetic energy and momentum per unit volume I denote by W_e and M_e respectively.

$$\left. \begin{aligned} W_e &= \frac{1}{8\pi} (E^2 + H^2) \\ M_e &= \frac{1}{4\pi c} [EH]. \end{aligned} \right\} \dots \dots \dots (70)$$

It is well known that

$$\frac{d}{dt} W_e + c^2 \text{Div } M_e = -\sigma u E;$$

where as before σ denotes the density of electric charge.

If σ is zero it follows that

$$\frac{d}{dt} W_e + \text{Div } (c^2 M_e) = 0, \dots \dots \dots (71)$$

so that the momentum is proportional to the flux of the energy. These results are of course well known.

The gravitational energy and momentum are W_n and M_n ,

$$\left. \begin{aligned} W_n &= \frac{1}{8\pi} (\nabla J)^2 + \frac{1}{8\pi c^2} \left(\frac{dJ}{dt} \right)^2 - mJ \\ M_n &= -\frac{1}{4\pi c^2} \frac{dJ}{dt} \nabla J. \end{aligned} \right\} \dots \dots \dots (72)$$

And
$$\frac{dW_n}{dt} + c^2 \text{Div } M_n = 0. \dots \dots \dots (73)$$

The total energy W is equal to $W_e + W_n$, the total momentum M to $M_e + M_n$.

Formulæ equivalent to (72) and (73) have already been published by Abraham.

(71) and (73) determine the flux of energy; it is also desirable to follow the flux of momentum. Let M the momentum have components M_x, M_y, M_z .

$$\begin{aligned} M &\equiv (M_x, M_y, M_z) \\ \left. \begin{aligned} \frac{dM_x}{dt} + \text{Div } P_x &= 0 \\ \frac{dM_y}{dt} + \text{Div } P_y &= 0 \\ \frac{dM_z}{dt} + \text{Div } P_z &= 0 \end{aligned} \right\} \dots \dots \dots (74) \end{aligned}$$

$$\left. \begin{aligned} P_x &\equiv (P, U, T) \\ P_y &\equiv (U, Q, S) \\ P_z &\equiv (T, S, R) \end{aligned} \right\} \dots \dots \dots (75)$$

The quantities on the right of (75) are the fictitious stresses.

It will be sufficient to consider here that form of our theory in which there is no true material substance but only æther. Then we have to do with gravitational and electro-magnetic energy. Let

$$P_x = P_{ex} + P_{nx}$$

$$P_{ex} \equiv W_e - \frac{1}{4\pi}(E_x^2 + H_x^2), -\frac{1}{4\pi}(E_x E_y + H_x H_y), -\frac{1}{4\pi}(E_x E_z + H_x H_z). \quad (76)$$

$$P_{nx} \equiv -W_n + \frac{1}{4\pi} \left(\frac{dJ}{cdt}\right)^2 + \frac{1}{4\pi} \left(\frac{dJ}{dx}\right)^2, \frac{1}{4\pi} \frac{dJ}{dx} \frac{dJ}{dy}, \frac{1}{4\pi} \frac{dJ}{dx} \frac{dJ}{dz} \dots \dots \dots (77)$$

It is sometimes necessary to deal with the flux of energy and momentum from a moving element of volume or across a moving surface. Let \mathbf{u} denote the velocity of dv .

Then instead of (71) and (73)

$$\frac{d}{dt'} (Wdv) + \text{Div} (c^2 \mathbf{M} - \mathbf{u} W) dv. \dots \dots (78)$$

And instead of (74) equations such as

$$\frac{d}{dt'} (M_x dv) + \text{Div} (P_x - \mathbf{u} M_x) dv = 0. \dots \dots (79)$$

From (78) and (79) it follows that the flux of energy across unit area of a surface moving with the normal velocity \mathbf{u}_n is

$$c^2 M_n - \mathbf{u}_n W, \dots \dots \dots (80)$$

where M_n denotes the normal component of \mathbf{M} .

The flux of momentum has the components

$$P_n - \mathbf{u}_n M. \dots \dots \dots (81)$$

P_n is the vector whose components are the stresses across the surface.

If the surface is a perfect reflector as before, I shall now show that conservation of energy and of momentum are secured by the condition (69) of last section, a condition which as we have seen is equivalent to supposing that there is no change of pressure in passing from "matter" to "æther."

Take the x axis normal to the surface of separation.

Referring to (81) and (76) it seems that the flux of electromagnetic momentum into the æther has the three

components:—

$$\begin{aligned} & \frac{1}{8\pi} (\mathbf{E}^2 + \mathbf{H}^2) - \frac{1}{4\pi} (E_x^2 + H_x^2) - \mathbf{u}_n(4\pi c)^{-1} (E_y H_z - E_z H_y), \\ & - \frac{1}{4\pi} (E_x E_y + H_x H_y) - \mathbf{u}_n(4\pi c)^{-1} (E_z H_x - E_x H_z), \\ & - \frac{1}{4\pi} (E_x E_z + H_x H_z) - \mathbf{u}_n(4\pi c)^{-1} (E_x H_y - E_y H_x). \end{aligned}$$

The surface conditions are

$$E_y - c^{-1} \mathbf{u}_n H_z = 0, \quad E_z + c^{-1} \mathbf{u}_n H_y = 0, \quad H_x = 0.$$

And by using these it can be shown that the flux of momentum is normal and equal to

$$\frac{1}{8\pi} (\mathbf{H}^2 - \mathbf{E}^2),$$

and also that the flux of energy is

$$\frac{1}{8\pi} (\mathbf{H}^2 - \mathbf{E}^2) \mathbf{u}_n.$$

The flux of gravitational momentum has the components

$$\begin{aligned} W_n + \frac{1}{4\pi} \left(\frac{dJ}{cdt} \right)^2 + \frac{1}{4\pi} \left(\frac{dJ}{dx} \right)^2 + \mathbf{u}_n(4\pi c)^{-1} \frac{dJ}{dx} \frac{dJ}{cdt}, \\ \frac{1}{4\pi} \frac{dJ}{dx} \frac{dJ}{dy} + \mathbf{u}_n(4\pi c)^{-1} \frac{dJ}{dy} \frac{dJ}{cdt}, \\ \frac{1}{4\pi} \frac{dJ}{dx} \frac{dJ}{dz} + \mathbf{u}_n(4\pi c)^{-1} \frac{dJ}{dz} \frac{dJ}{cdt}. \end{aligned}$$

Across the bounding surface of matter J the gravitational potential and its first differential coefficients are continuous. But the gravitational energy containing the term $-mJ$ changes abruptly.

The total flux of momentum across the surface into æther is therefore greater than the flux out of matter by the normal component

$$\frac{1}{8\pi} (\mathbf{H}^2 - \mathbf{E}^2) - mJ.$$

This is by (69) equal to

$$V_a - V_m,$$

and the fluxes of energy will be found to differ by

$$(V_a - V_m) \mathbf{u}_n.$$

It follows therefore that matter behaves as if the external tension

$$V_m - V_a$$

were applied to its surface. This represents the action of a body force

$$\nabla V$$

which arises from the external potential V .

When this potential is continuous it has no effect whatever. But if forces are applied only to matter or only to æther, or if the forces are not continuous at the surface, then the quantity $V_m - V_a$ does not vanish. I return in the last section to discuss the application of such a potential function.

I have spoken of the quantities which appear in (75) as the fictitious stresses. It may be asked what are the real stresses. These ought to account for the transfer of energy and momentum alike. Cunningham (Proc. Roy. Soc. vol. lxxxiii. p. 109) has shown how such stresses are to be determined.

Suppose electromagnetic momentum to be due to the motion of a substance. The stresses required are those which act across a surface moving with the same velocity as the substance.

Let \mathbf{u}_0 be this velocity. Then Cunningham shows that

$$m_0^2 \mathbf{u}_0 = \frac{1}{4\pi c} [\mathbf{E}\mathbf{H}],$$

$$\frac{1}{2} m_0^2 (c^2 + \mathbf{u}_0^2) = \frac{1}{8\pi} (\mathbf{E}^2 + \mathbf{H}^2).$$

Here it is evident that m_0 in the expression for the momentum and energy plays the same part as does the density ρ in the fluid of § 1. The stress system acting in this fluid is a tension

$$\frac{1}{8\pi} (\mathbf{E}^2 - \mathbf{H}^2),$$

and an equal pressure in directions perpendicular to the tension. The direction of the tension is parallel to either of the (parallel) vectors \mathbf{E}_0 and \mathbf{H}_0

$$\mathbf{E}_0 = \mathbf{E} + \frac{1}{c} [\mathbf{u}_0 \mathbf{H}] \quad \text{and} \quad \mathbf{H}_0 = \mathbf{H} - \frac{1}{c} [\mathbf{u}_0 \mathbf{E}].$$

Notice, however, that there is no equation of continuity. If m_0 be regarded as the density then matter appears or disappears according to no simply determined formula.

At a reflecting surface the momentum is parallel to the surface. If that surface moves momentum disappears across it.

But the stress system just considered involves a shear at the surface of reflexion, which accounts for this transfer of momentum.

We saw in § 6 that with the system there adopted the pressure of æther can be continuous at the boundary. It follows therefore that the electromagnetic stresses across the bounding surface vanish. In fact the stress system to which our methods lead differs from Cunningham's owing to the fact that part of the electromagnetic stress is transferred to the fluid pressure of the æther. It is also to be remembered that in four dimensions there is no electromagnetic momentum but only stress, all momentum is due to the liquid motion of the æther.

We have by combining (71) and (74)

$$\left. \begin{aligned} \frac{d}{ds} W_e + \frac{d}{dx} (cM_{ex}) + \frac{d}{dy} (cM_{ey}) + \frac{d}{dz} (cM_{ez}) &= 0, \\ \frac{d}{ds} (cM_{ex}) + \frac{d}{dx} P_e + \frac{d}{dy} U_e + \frac{d}{dz} T_e &= 0, \\ \frac{d}{ds} (cM_{ey}) + \frac{d}{dx} U_e + \frac{d}{dy} Q_e + \frac{d}{dz} S_e &= 0, \\ \frac{d}{ds} (cM_{ez}) + \frac{d}{dx} T_e + \frac{d}{dy} S_e + \frac{d}{dz} R_e &= 0. \end{aligned} \right\} \quad (82)$$

These equations indicate that the energy and the momentum multiplied by c are the stresses in the direction of the s axis, and that they form a system in equilibrium. But the equation (61) shows that the electromagnetic field produces a force on unit volume of æther of amount

$$\frac{1}{8\pi} \nabla (H^2 - E^2).$$

Hence there must be a reaction equal and opposite to this against the polarizing apparatus. The results (82) do not, therefore, indicate the true electromagnetic stresses. These are not in equilibrium with each other but with the applied force

$$\frac{1}{8\pi} \nabla (E^2 - H^2).$$

Thus the second line for example of (82) ought to be written

$$\begin{aligned} \frac{d}{ds} (cM_{ex}) + \frac{d}{dx} \left(P_e + \frac{1}{8\pi} E^2 - \frac{1}{8\pi} H^2 \right) + \frac{d}{dy} (U_e) + \frac{d}{dz} (T_e) \\ = \frac{1}{8\pi} \nabla (E^2 - H^2). \end{aligned}$$

And the true stresses form the system (83):

$$\left. \begin{aligned} W_e - \frac{1}{8\pi} (E^2 - H^2), \quad cM_{ex}, \quad cM_{ey}, \quad cM_{ez}, \\ cM_{ex}, \quad P_e + \frac{1}{8\pi} (E^2 - H^2), \quad U_e, \quad T_e, \\ cM_{ey}, \quad U_e, \quad Q_e + \frac{1}{8\pi} (E^2 - H^2), \quad S_e, \\ cM_{ez}, \quad T_e, \quad S_e, \quad R_e + \frac{1}{8\pi} (E^2 - H^2), \end{aligned} \right\} \dots \quad (83)$$

This system of stresses may be submitted to a Lorentz-Einstein substitution. The simplest results are obtained when we so transform that the new electric and magnetic vectors

$$E_0 \quad \text{and} \quad H_0$$

became parallel, as with Cunningham.

$$\text{Then} \quad [E_0 H_0] = 0,$$

and the three components of momentum, the "shears"

$$cM_{ex}, \quad cM_{ey}, \quad cM_{ez},$$

in (83) all vanish.

Next take the x -axis in the direction of E_0 or H_0 , then the shears

$$S_e, \quad T_e, \quad U_e$$

vanish, as appears from (76). There are left, therefore, only the principal stresses in (83).

Using again the values in (76), we have

a pressure $(4\pi)^{-1} H_0^2$ along the transformed time-axis,

a tension $(4\pi)^{-1} H_0^2$ along the direction of H_0 ,

and in directions perpendicular to E_0 a pressure $(4\pi^{-1}) E_0^2$.

The values of E_0 and H_0 are easily calculated,

$$E_0^2 - H_0^2 = E^2 - H^2, \quad E_0 H_0 = EH.$$

For the difference of the squares of E and H and their scalar product are invariant.

With the stress system of (83) it appears that all stresses across the surface of matter vanish. For this surface will have some such equation as

$$f(xyzs) = 0.$$

By transforming to the local time and to axes moving with

the velocity u_n of any point on the surface the equation of the surface in the neighbourhood of that point can be written

$$dx = 0,$$

The axis of x being taken along the normal.

The conditions at the material surface are now

$$E_y = E_z = H_x = 0,$$

since referred to the local axes the surface has zero velocity. And hence it can be shown that all stresses across the surface of matter, forming the second line of (83), vanish.

§ 8. POSITIVE AND NEGATIVE CHARGE, MAGNETON AND ELECTRON.

In the paper already referred to I suggested a distinction between positive and negative electricity. At that time I was content to retain the continuous electric fluid; this gave one type of electricity. But I also contemplated the existence of closed surfaces, such as are now taken to be the boundaries of matter. The electric induction over such a surface is constant. Here, then, we have another type of electric charge.

I have abandoned the electric fluid. It might be possible to construct a second type of electric charge by making the conducting surface merely a cavity in the æther. I prefer now to identify provisionally positive and negative charges as magnetons and electrons. The theory is simple. Maxwell's equations give

$$\left. \begin{aligned} \frac{d}{dt'} \iint \mathbf{E} d\mathbf{S} &= c \int \mathbf{H}' dr \\ \frac{d}{dt'} \iint \mathbf{H} d\mathbf{S} &= -c \int \mathbf{E}' dr \end{aligned} \right\} \dots \dots (84)$$

Here $\mathbf{E}' = \mathbf{E} + c^{-1} [\mathbf{u}\mathbf{H}]$ and $\mathbf{H}' = \mathbf{H} - c^{-1} [\mathbf{u}\mathbf{E}]$,

$d\mathbf{S}$ is an element of area moving with the velocity \mathbf{u} , and dr is an element of length of its boundary. (84) shows that over any closed surface whatever

$$\iint \mathbf{E} d\mathbf{S}$$

is a constant, or the electric induction is a constant. This defines the electric charge on the surface.

Now suppose the given surface is multiply connected and $d\mathbf{S}$ is an element of area of any barrier drawn across one of its apertures. dr is then an element lying in the original

surface, and the tangential component of E' is zero. Hence in (84)

$$E'dr = 0,$$

and therefore

$$\iint H dS$$

is a constant. Thus the magnetic induction through any aperture is constant.

It is evidently arbitrary to give always a negative sign (that of the electron) to the charge on the simply connected material surface, and a positive sign to the charge of a magneton. But any theory whatever must be in this sense arbitrary. What is important is to notice that our distinction between positive and negative charges suggests a reason for the difference of mass.

Taking the boundary condition (69)

$$\frac{1}{8\pi} (E^2 - H^2) + mJ = V_m - V_a,$$

it is evident that written in the form

$$\frac{1}{8\pi} E^2 = \frac{1}{8\pi} H^2 - mJ + V_m - V_a$$

it suggests that E^2 is larger in the magneton than in the electron. So too, therefore, may be the electromagnetic mass.

§ 9. THE ELECTROMAGNETIC EQUATIONS IN MOVING ÆTHER.

I am aware that such a theory of the æther as is maintained in this paper will appear quite unsatisfactory to those who are unwilling to accept a four-dimensional universe as the physical reality underlying our changing experience. It will appear to them inexplicable that the motion of æther should produce no result on the motion of light. I shall now show that the four-dimensional theory is capable of a rational expression in terms of ordinary space and time concepts.

What is required is some form of the electromagnetic equations which describe the course of events at points moving with the moving æther. The time variable must be in fact local to points of the æther. Such a time variable is at once given by the Newtonian potential itself. I write

$$t_a = -J/c^2, \quad . \quad . \quad . \quad . \quad . \quad (85)$$

then

$$dt_a = \rho (dt - u dx/c^2). \quad \text{By (40).}$$

Compare this with the Local-Time of Lorentz. If a rigid material system moved with the velocity \mathbf{u} of the æther at any one point, the time t_1 local to this system would satisfy the equation

$$dt_1 = (1 - \mathbf{u}^2/c^2)^{-\frac{1}{2}} (dt - \mathbf{u}d\mathbf{r}/c^2).$$

\mathbf{u} is here a constant, the velocity at the point chosen.

Also the density of the æther measured relative to the system would be given at this point by

$$\rho_a = (1 - \mathbf{u}^2/c^2)^{-\frac{1}{2}} \{ \rho - \rho \mathbf{u} \cdot \mathbf{u} / c^2 \} = (1 - \mathbf{u}^2/c^2)^{\frac{1}{2}} \rho. \quad (86)$$

Hence

$$\rho_a dt_1 = \rho (dt - \mathbf{u}d\mathbf{r}/c^2),$$

and within an infinitesimal range of any point of the æther the local time of Lorentz and the æther time t_a defined by (85) are connected by

$$dt_a = \rho_a dt_1. \quad . \quad . \quad . \quad . \quad . \quad (87)$$

In the four-dimensional space of Minkowski any given value of t_1 defines a Euclidean space. This space is a tangent to the region defined by any value of t_a . The two regions touch at the point from which the local time t_1 is taken.

The position of a material particle in three dimensions has so far been defined simply by the coordinates of the point in which a four-dimensional stream-line is cut by the region for which t_1 has any given value. In the same way the point in which any stream-line cuts the three-dimensional space given by any value of J or t_a is now to define the position of a material particle.

Let dv_a be the volume of any element of æther. The equation of continuity is

$$\frac{d}{dt_a} (\rho_a dv_a) = 0. \quad . \quad . \quad . \quad . \quad . \quad (88)$$

For take any four-dimensional tube of flow of the æther. The section made by giving any constant value to J is a three-dimensional volume dv_a . ds_a , the element of length of a tangent to the tube, is given by

$$ds_a = c dt_1, \quad . \quad . \quad . \quad . \quad . \quad (89)$$

where, as before, t_1 is the local time of Lorentz.

Under the Lorentz-Einstein substitution

$$\iiint dv ds$$

is an invariant; and

$$dv_a ds_a$$

is the "volume" of æther which has flowed across the section dv_a of a tube, ds_a being the distance the æther has moved along it. Also (24) may be written

$$\frac{ds_a}{d\tau} = \rho_a c (4\pi)^{-\frac{1}{2}}.$$

So that $dv_a ds_a$ varies as $\rho_a dv_a$. Hence the equation of continuity is expressed by making

$$\rho_a dv_a$$

a constant along the tube, that is by (88).

I now write the electromagnetic equations in a form due to Hargreaves (Camb. Phil. Trans. vol. xxi. p. 107)*.

$$\left. \begin{aligned} \iint (E_1 dy dz + E_2 dz dx + E_3 dx dy \\ - H_1 dx c dt - H_2 dy c dt - H_3 dz c dt) = 0, \\ \iint (H_1 dy dz + H_2 dz dx + H_3 dx dy \\ + E_1 dx c dt + E_2 dy c dt + E_3 dz c dt) = 0, \end{aligned} \right\} \quad (90)$$

The expressions on the left of (90) are differential invariants. Apply (90) to a region bounded by the tubes of flow or by equipotentials where J or t_a have constant values.

Then by (87) write in (90)

$$dt_1 = \rho_a^{-1} dt_a.$$

The equations (90) yield the results

$$\iint E dS_a - \iint H \rho_a^{-1} dx_a c dt_a = 0,$$

$$\iint H dS_a + \iint E \rho_a^{-1} dx_a c dt_a = 0;$$

dS_a is any element of area lying in the space defined by a constant value of t_a ; dx_a is an element of length of the curve bounding this area. Write

$$E = \rho_a E_a, \quad H = \rho_a H_a,$$

* See H. Bateman, Proc. Lond. Math. Soc. ser. 2, vol. viii. p. 227.

and the equations are

$$\left. \begin{aligned} \frac{d}{dt_a}(\rho_a \mathbf{E}_a dS_a) &= c \int \mathbf{H}_a d\mathbf{r}_a = c \text{Curl } \mathbf{H}_a dS_a, \\ \frac{d}{dt_a}(\rho_a \mathbf{H}_a dS_a) &= -c \int \mathbf{E}_a d\mathbf{r}_a = -c \text{Curl } \mathbf{E}_a dS_a, \end{aligned} \right\} . \quad (91)$$

It must be remembered that the space is not Euclidean, except in infinitesimal portions.

Thus (91) shows that the specific inductive capacity and magnetic permeability of the æther are equal and proportional to its density.

There is a point of resemblance to Stokes's theory of aberration. Referred to the local time t_1 kept by a rigid body moving with the æther at any point write (40)

$$\rho_1 \mathbf{u}_1 = \nabla J, \quad \rho_1 c = -\frac{dJ}{cdt_1}.$$

The equation

$$\text{Curl } \rho_1 \mathbf{u}_1 = 0,$$

becomes in the neighbourhood of this point since the velocity \mathbf{u}_1 is there zero

$$\text{Curl } \mathbf{u}_1 = 0.$$

Hence the motion viewed from any moving particle of æther is in the ordinary sense irrotational for points in the immediate neighbourhood.

The equations (91) seem to show that in regions where ρ_a has different values the velocity of light varies inversely as ρ_a the density of the æther. Could such a result be observed? Not if the velocity of light is measured, as it must be, by the passage of observable events, by the ticking of the clock.

To measure velocities at all a constant material system is required, moving with the æther at the point and keeping the local time t_1 . The motion of the pendulum will in this system be defined by a variable θ such that

$$\frac{d^2\theta}{dt_1^2} + n^2\theta = 0.$$

Making the substitution (87)

$$\rho_a^2 \frac{d^2\theta}{dt_a^2} + n^2\theta = 0.$$

If the velocity of light is decreased inversely as ρ_a the

time of vibration of the pendulum is increased directly as ρ_a . Measured by the number of vibrations light has the same velocity as before.

§ 10. THE LIMITS OF MECHANICAL THEORY.

The quantity ρ_a of last section is assumed to be real. By (86)

$$c^2 \rho_a^2 = \left(\frac{1}{c} \frac{dJ}{dt} \right)^2 - (\nabla J)^2.$$

Hence J is not precisely the Newtonian potential, or near attracting matter ρ_a would be imaginary. In fact, J is by (40) the velocity-potential. Suppose the æther at infinity to be at rest and of density ρ_0 . Write

$$J = J_0 - \rho_0 c^2 t. \dots \dots \dots (92)$$

$\frac{dJ_0}{cdt}$ as well as ∇J_0 vanish at infinity, and the equation

$$\left(\nabla^2 - \frac{1}{c^2} \frac{d^2}{dt^2} \right) J_0 + 4\pi m = 0$$

now shows that J_0 is the Newtonian potential.

Turn to (69), the only other result in which J is involved. It is

$$\frac{1}{8\pi} (H^2 - E^2) - mJ_0 + m\rho_0 c^2 t + V_m - V_a = 0.$$

Now suppose

$$V_m = \mathbf{a} - m\rho_0 c^2 t, \dots \dots \dots (93)$$

and then

$$\frac{1}{8\pi} (E^2 - H^2) + mJ_0 = \mathbf{a} - V_a \dots \dots \dots (94)$$

(93) implies that a constant force along the time-axis is applied to each element of matter. This is evidently an essential feature of our theory, and not an afterthought. For matter was to form a constant configuration standing against the stream of æther. That is the meaning of the transformation (B) of § 4. Whether, therefore, matter is a region of growth or decay, a constant force must be applied so that it may not be carried bodily down the stream.

It may be objected that if the æther at a distance is at rest relative to one three-dimensional system, it is in motion relative to any other. But this is quite harmless. The condition (94) is invariant according to the principle of

relativity, since J_0 vanishes at infinity. V_m in (93) transforms by any Lorentz-Einstein substitution so as to give a force just balancing the momentum flowing in to matter from infinity. Thus the gravitational attraction is due only to the potential J_0 .

I think that at this point the limits of mechanical theory are reached. I should hardly expect the views maintained in this paper to be seriously regarded but for one circumstance. There is a widespread feeling that something is amiss with the classical mechanical theories of matter. They fail, and seem to fail without hope, of reaching any solution of the problems of radiation. Here the conflict between fact and theory seems insoluble. Some license may perhaps be allowed, therefore, to speculations which retain as much as possible of the mechanical spirit and yet allow a natural way of escape from its limitations.

The function V_a of (94) represents in effect a tension applied to the surface of matter. Suppose we resign the attempt to account for its presence mechanically. It is derived from a potential function V_a existing in the æther. Any further knowledge of its properties remains to be derived from observations of the laws of nature. What is important is that this externally applied force does not disturb the electromagnetic field or the irrotational motion of æther.

Conservation of energy and momentum are practically secured if on the average

$$\iiint \nabla V_a dv_a dt = 0, \quad \iiint \frac{dV_a}{dt} dv_a dt = 0.$$

These conditions are consistent with the principle of relativity. They attribute energy of amount V_a in unit volume to the æther.

It seems to me that Einstein's quantum is an idea belonging to the same order as these. It too involves an extra-mechanical constraint. But the quantum introduces into Physics ideas which seem incapable of coming to any kind of terms with ordinary mechanical concepts. I suggest that we ought rather to seek some system in which as much as possible of the old may be retained. That is the end sought in this essay.

April 1913.

LIV. *A Method for the Determination of Radium in Radioactive Substances.* By ARNOLD LOCKHART FLETCHER, M.A., B.E., *Royal College of Science for Ireland* *.

THE radium content of certain radioactive substances has been given by Professor Strutt in a paper on the uranium-radium ratio of minerals by the method of heating the powdered mineral in a glass tube and transferring the liberated emanation to an electroscope †. It has been pointed out by Boltwood ‡ that in certain cases the incomplete de-emanation of the powder may involve an error which may amount to as much as 46 per cent. in a mineral heated to redness.

The method described in the present paper, which is essentially that first employed by Professor Strutt, was devised in order to minimise the possibility of the source of error mentioned, is at the same time very simply carried out and does not involve the use of any apparatus outside the scope of the laboratory. The analyses are carried out more rapidly than is the case with the electric furnace, with accuracy and without expense.

The micro-furnace, an instrument for rapid analysis of alloys and minerals which has been elsewhere described more fully by me, is used. It consists of a brass drum sliding on a slate cylinder which is perforated from below to allow of the passage of two wires connected to terminals on the upper face of the cylinder. These terminals clamp a thin rod of arc carbon which is heated by the passage of an electric current of about 10 amperes per sq. mm. of cross-section (max.). The brass drum, which slides on the cylinder, may be adjusted in any position, and the size of the chamber varied accordingly. This chamber is enclosed above by a plate of glass or transparent silica cemented to a brass frame resting on the rim of the drum. In these experiments the upper rim was greased with vaseline, and the lower rim covered by a rubber band to prevent leakage. In this application of the micro-furnace a chamber of adjustable size is not necessary, and the estimation may be carried out in any box fitted with inlet and outlet tubes and terminal clamps to make contact with a carbon rod.

The general disposition of the apparatus is shown in

* Communicated by the Author.

† Strutt, Proc. Roy. Soc. lxxiii. p. 191 (1904).

‡ Boltwood, Am. Jour. Sci. xxv. p. 294 (1908).

fig. 1. A small splintered and weighed fragment of the mineral or salt (say .01 to .0001 gram) is placed in a hollow in the

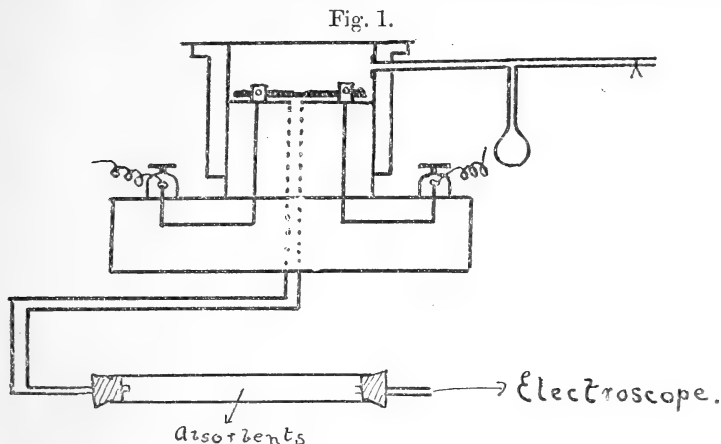

carbon rod, and the cover-glass adjusted. The current is passed through the rod which is heated to $2000^{\circ}\text{C}.$ – $3000^{\circ}\text{C}.$ for from 10 to 30 seconds. If the mineral decrepitates it should be covered with a fragment of carbon to prevent its escape. The small rubber balloon (about 100 c.c. capacity) allows for the expansion of the air and production of carbon dioxide. The combined effect is very small. The electroscope, which had been exhausted, refilled and observed, is now again exhausted and filled through the chamber and through calcium chloride, soda-lime, phosphoric oxide, and a plug of cotton-wool to absorb the ions generated in the furnace. These tubes only require refilling at wide intervals of time, and hence the apparatus is always ready for an estimation, which may be made in from 20 to 30 minutes in all. A length of capillary tubing is inserted to protect the leaf and ensure uniformity in the rate of filling. The collapse of the leaves is then observed in the usual way. The operation does not involve the use of chemicals, and the carbon rod has at no time when heated alone or with non-radioactive minerals been found to affect the discharge-rate of the leaf-system.

The results of several analyses are given below in illustration of the method, and their concordance is a sufficient illustration of its utility. The percentage error is small in spite of the minute quantities dealt with. As the mineral is not powdered in these experiments, the emanation loss in the cold is disregarded.

The following table shows the comparison between the ratio of the weights of some minerals tested and the ratio of the corresponding gains in leak conferred upon the electro-scope. The absolute results are in all cases approximately those which are to be expected from the uranium content of the mineral. The number obtained for the constant of electro-scope A (0.7×10^{-12}) is identical with that obtained for a similar electro-scope in many experiments by the solution and tube-furnace methods.

Mineral.	Amount taken in grams.	Gain in rate of electro-scope leak 3 hrs. after admission in scale-divs. p. h.	Ratio of wts. taken.	Ratio of leaks.	Constant of electroscopes $\times 10^{12}$.	Radium present $\times 10^7$ in grs. per gram.
Uraninite (Elec. A)	1 ...	0003	87	1.0	1.0	0.7
	2 ...	000205	70	0.7	0.8	0.6
	3 ...	0006	175	2.0	2.0	0.7
Uraninite (Elec. B)	1 ...	0004	64	1.0	1.0	1.28
	2 ...	0006	95	1.5	1.5	1.27
	3 ...	0009	145	2.2	2.3	1.36
	4 ...	0007	110	1.7	1.7	1.30
Gummite	1 ...	0004	114	1.0	1.0	...
	2 ...	000625	150	1.6	1.3	...
	3 ...	0008	185	2.0	1.6	...
Torbernite.	1 ...	00025	35	1.0	1.0	...
	2 ...	00028	44	1.1	1.3	...
Euxenite	1 ...	00041	21	1.0	1.0	...
	2 ...	0022	133	5.4	6.3	...

Escape of Emanation in relation to Temperature.

The following curve was obtained by means of a thermocouple placed between two square carbon rods placed side by side and heated, and shows the relation between the amount of emanation liberated from a small quantity of uraninite in one minute and the temperature at which the uraninite is maintained. The mineral speck was kept at the particular temperature for one minute, and the disengaged emanation drawn off. The total heating extended for 2 minutes.

The curve obtained shows that the emanation does not begin to come off freely under 750°C , near which temperature the sharp bend shows a rapid increase in the amount liberated. The points obtained can be repeated to within one or two per cent. The observations made by Boltwood*

* Am. Jour. Sci. xviii. p. 97, footnote (1904).

that samarskite gave off 10 per cent. of its emanation at low red heat (say 600° C.) and 20 per cent. at bright red heat (say 800° C.), and that uraninite gave off 54 per cent. of its emanation at bright redness are in accordance with the above

Fig. 2.

ESCAPE OF RADIUM EMANATION
FROM PITCHBLENDE.

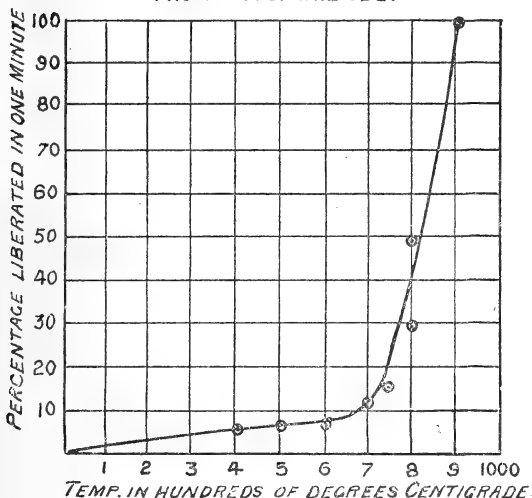

results. Comparatively large differences between the amounts liberated at bright redness can easily be accounted for at this region of the curve. Complete de-emanation takes place at full redness.

It may be supposed that with quantities of pitchblende of the order of one or two milligrams the escape of emanation is practically instantaneous, and de-emanation at high temperatures was found to be complete in a few seconds.

If it is desired to investigate solutions, as in dealing with filtrates, a comparatively large amount of substance may be dissolved into solution, and an accurately known small quantity placed on the carbon by means of a capillary pipette. The rod is then examined as before after a period of a month.

I am much indebted to Professor G. A. J. Cole for the mineral specimens, and to Professor Morgan and Dr. Pollok for their interest in the work.

Royal College of Science for Ireland,
Dublin, June 1913.

LV. *A Case of Anomalous Conduction in a Solid Dielectric.*
 By W. F. G. SWANN, D.Sc., A.R.C.S., Assistant Lecturer
 in Physics at the University of Sheffield*.

(1) **T**HE conductivity produced by the action of X rays in dielectrics has been investigated by several observers. The present paper, however, deals with the natural conductivity of paraffin-wax when under the influence of no external agency except the electric field responsible for the current. The experiments suggest that Ohm's law is not obeyed, the conductivity increasing in fact with the field. The fact is of interest because it has an important bearing on the mechanism of the conduction; but these theoretical considerations will be dealt with after the experiments have been described.

The natural conductivity of paraffin-wax being so small, we are able, and indeed we are obliged, to employ potential gradients enormously greater than those employed in the case of good conductors. The potential gradients employed in the present work are of the order 50,000 volts per centimetre.

At first sight, the simplest way to investigate the relation between the current and the potential gradient would be to place the wax between two plates, one connected to an electrometer and the other kept at a potential of say 10,000 volts, and to note the rate of leak into the electrometer. Apart from the difficulty of obtaining a battery giving 10,000 volts, however, the slightest fluctuation in the potential of the battery and consequently of the plate connected to it would, owing to inductive action on the plate connected to the electrometer, cause movements of the needle such as to entirely mask the movements due to the conduction of the electricity across the wax. Again, in order to avoid trouble due to leakage through the air, it is necessary that the charged plate should be embedded entirely in the wax; and even then it is necessary that the wax faces remote from the charged plate should be kept at zero potential, as, if any part is exposed, it is liable to get up to a high potential and cause slow discharge from the air.

The apparatus represented in fig. 1 was devised to overcome these effects, and it further had the advantage, as will be seen later, of not indicating the part of the current obeying Ohm's law, but only the part corresponding to the deviation from

* Communicated by the Author.

that law. A, B, C are three parallel plates. The distance between A and C was about 2 mm., and that between B and C about 1.2 cm. G and H are guard-rings. The plates A and B were about 6.5 cm. in diameter. The space between

Fig. 1.

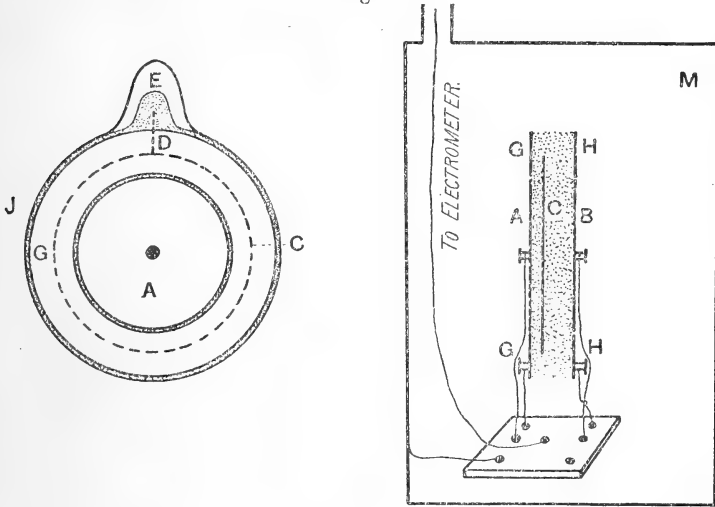

the plates was filled with paraffin-wax which was run in hot while the plates themselves were held in a specially constructed vessel which served to hold them in position. The narrow sides of the vessel were of glass so that one could look through, and remove any air-bubbles. If air-bubbles are present, slow discharge is apt to take place across them until both sides are at the same potential, thus causing irregularities in the readings. As an additional precaution the wax was heated for some time to about 110° C. and subjected to a vacuum before being used.

The letters assigned to the different plates in fig. 1 will be adhered to throughout the paper. A side view of the apparatus is shown to the right of the figure. J is a metal ring which fitted over the side of the apparatus and kept it at zero potential. A rod D from the centre plate ended just above the circumference of the guard-ring, and was completely enclosed in the paraffin-wax protuberance E. (These parts for convenience are not shown in the right-hand figure.) A very fine hole in the protuberance enabled a piece of thin wire to be pushed down so as to make connexion to the rod attached to the plate, and in this way the latter could be charged. The fine wire was immediately removed

after the operation, and the hole was sealed up with wax by touching it with a hot iron. These precautions to prevent exposure to the air of the wire fixed to the plate C were quite necessary; for if they were not taken, the slight discharge which took place from the end of the rod through the air was so important as to destroy the accuracy of the measurements.

After the apparatus had been charged it was hung up in the earthed tin box M, and the plates A, B, G, H were connected to separate mercury cups in a paraffin block. The holes in the block were arranged so that any of the plates could be earthed or connected to the electrometer at will.

The experiments were conducted as follows:—The plates A, B, G, H having been all earthed, they were then all insulated except A which was connected to the electrometer. The time having been noted, the electrometer quadrant was released from earth by pulling a string, and the rate of movement of the needle was noted, observations being taken at intervals of a period of the needle in order to avoid inertia effects, in the manner described in a former paper by the author*. A series of readings having been taken, the plates and the guard-rings were all earthed again, and the observations were repeated. Similar observations were then taken for the plate B, and the sensitiveness of the electrometer was measured. Observations were taken in this manner extending over a day, and sometimes over two days. By plotting the rate of movement of the needle against the time (certain corrections being applied as described below), a curve was obtained the shape of which depended on the laws governing the conduction of the electricity in the wax.

A large number of experiments were performed, but it is unnecessary here to show the curves for each experiment, since they all show the same characteristics. The results of two experiments are given below, one in which the internal plate was charged positively, and the other in which it was charged negatively. It was not expected nor was it found, that the shape of the curve depended on the sign of the charge given to the internal plate, for on no theory of the conduction would this result.

The sensitiveness of the electrometer could be varied by varying the potential of the needle, and corrections were made when necessary for want of proportionality between the deflexion and the potential of the quadrant, and for slight fluctuations of the sensitiveness of the instrument. The numbers in the first columns of the tables represent the deflexions produced in 56 seconds, all the readings being

* Phil. Mag. ser. 6, vol. xxiv. p. 445, Sept. 1912.

corrected as above, and reduced to a fixed value of the sensitiveness of the electrometer, viz. 30.0 divisions deflexion for a potential difference between the quadrants equal to the E.M.F. of one cadmium cell. Each observation in the table represents the mean of two sets of observations taken successively; and each set itself comprised eight observations, from which a mean value was obtained by a systematic combination of the readings. The successive readings in each set agreed to about 0.5 per cent. In the case where the plate C was charged positively the potential of the needle was of opposite sign to that when C was charged negatively; so that while positive numbers in the tables correspond to a rise in potential for the first case, they correspond to a fall for the second.

Centre Plate charged Positively.

Plate A.

Plate B.

Movement in 56 secs. (Reduced as above).	Mean Time (in hours and decimals of an hour).
+69.5	1.94
53.2	2.21
39.5	2.63
32.2	3.01
22.8	3.71
19.5	4.14
14.0	5.07
11.0	6.14
7.56	7.42
5.5	9.11
4.6	10.51
3.4	12.72
1.5	25.53

Movement in 56 secs. (Reduced as above).	Mean Time (in hours and decimals of an hour).
-56.3	2.09
46.5	2.31
35.1	2.76
27.4	3.11
20.3	3.83
17.5	4.24
12.7	5.19
10.1	6.24
7.0	7.55
5.2	9.21
4.2	10.63
3.3	25.92

Centre Plate charged Negatively.

Plate A.

Plate B.

Movement in 56 secs. (Reduced as above).	Mean Time (in hours and decimals of an hour).
+51.9	2.74
42.5	2.99
32.3	3.37
25.2	3.92
16.6	5.04
12.1	6.36
8.0	7.98
6.55	9.73
4.5	12.54

Movement in 56 secs. (Reduced as above).	Mean Time (in hours and decimals of an hour).
-42.5	2.86
35.6	3.09
27.2	3.49
21.7	4.06
14.7	5.14
11.0	6.47
7.2	8.14
5.8	9.84
4.0	12.72

It will be noticed from the curves in figs. 2 and 3, which are drawn to correspond to the observations, that, for example, when C is positively charged, A rises in potential, while

Fig. 2.

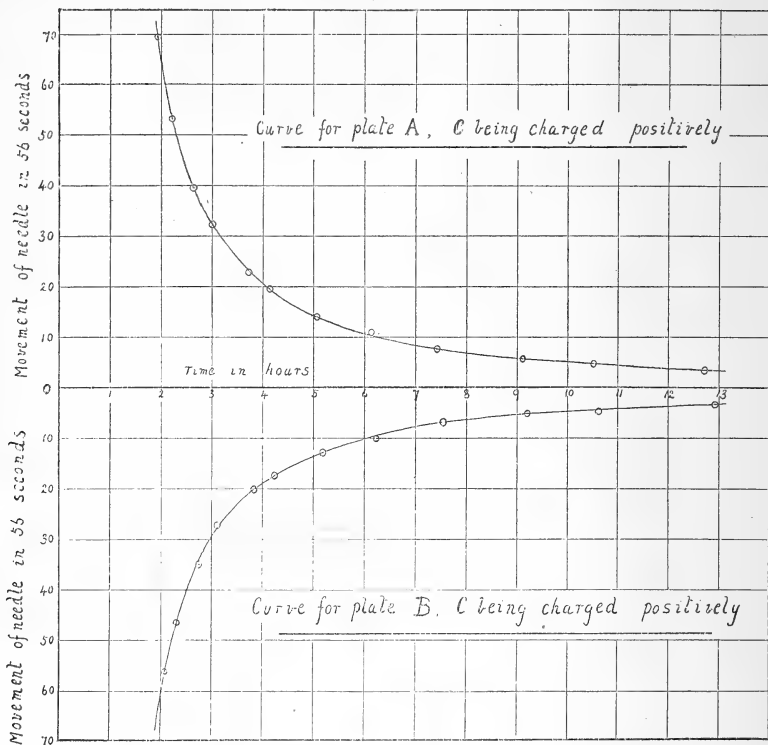

B falls; the electrometer readings being practically of the same magnitudes but of opposite sign for the two plates. The reason for this will readily appear when we consider the theory of the experiment, which we will now proceed to do.

(2) *Theory of the Experiment.*—In the first place we may remark that if the conductivity is due to ions existing in the dielectric which are not produced by the field, or in fact if the conductivity is brought about by any action taking place in conformity with Ohm's law, neither the plate A nor the plate B should alter in potential as time goes on. For, if V is the potential of C, A and B being both initially zero, and

if a and b are the distances between C and A and between C and B respectively, and if, further, i_a and i_b represent the

Fig. 3.

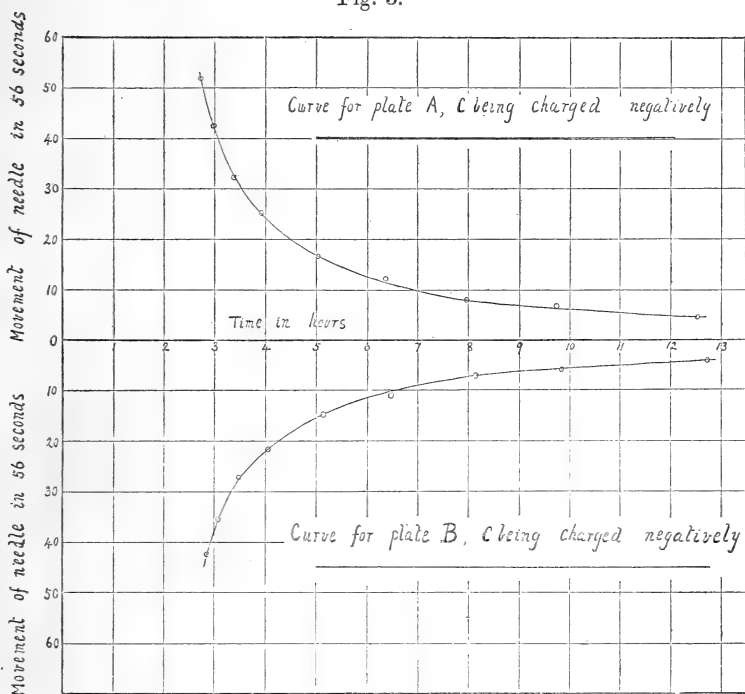

current densities between C and A and between C and B respectively, we have on the assumption of Ohm's law

$$i_a = \frac{kV}{a}, \quad i_b = \frac{kV}{b},$$

where k is a constant.

At the end of the time δt the effect on the potential of all the bodies concerned is the same as if a quantity of electricity of amount $\frac{kV}{a} \delta t$ per sq. cm. had been transferred in the form of a layer from C to A and a quantity $\frac{kV}{b} \delta t$ per sq. cm. had been transferred in the form of a layer from C to B. Now if an infinite layer of electricity of surface density σ is moved through a distance x towards a point P, the potential of the point will be raised by $2\pi\sigma x/\kappa$, where κ is the specific inductive capacity of the medium; so that applying this to

the present problem, we see that the potential of the plate A will have altered at the end of the time δt by the amount

$$\delta v = \frac{2\pi}{\kappa} \left\{ \frac{kVa}{a} - \frac{kVb}{b} \right\} \delta t = 0^*.$$

An analogous remark applies to the plate B.

If in the case of ordinary conduction by ions the fields are so great as to approach saturation values for the currents, the transference would be less than the amount calculated from the normal conductivity; but the transference from C to A would be reduced in greater proportion than the transference from C to B, owing to the greater field in the former case; and the result would be that if C were positively charged A would gradually fall in potential while B would rise, which is opposite to the results of the present experiments.

It seems rather startling at first sight that on the hypothesis of a constant ionization the plates A and B should remain at zero potential as the electricity leaks across; but it is nevertheless true, and was verified experimentally by performing experiments with paraffin oil, in which case we know that the main effects are to be attributed to the presence of ions existing in constant amount in the oil.

The results obtained above for paraffin-wax are not readily explained by an appeal to the phenomenon of residual charge, as will appear later. They may, however, be explained if we assume that the current is not proportional to the potential gradient. Let us write the current density i as a function

of the potential gradient $\frac{dV}{dx}$ in the form

$$i = f\left(\frac{dV}{dx}\right).$$

The current density between C and A is

$$i_a = f\left(\frac{V}{a}\right);$$

* A difference in the quality of the wax on the two sides of the plate would result in δv being different from zero. In the apparatus used there was no chance of this occurring, however, as the wax was stirred and run in hot. Moreover, observations were taken with different pieces of apparatus.

A variation of κ with the field would also result in δv being different from zero. We should, however, expect κ to increase with the field if it altered at all, which would result in δv being negative instead of positive as found.

so that, as far as this effect is concerned, there will be a rise in the potential of the plate A at the rate of $\frac{2\pi a}{\kappa} f\left(\frac{V}{a}\right)$ units per second. On the other hand, the transference from C to B results in a fall of potential of the plate A at the rate $\frac{2\pi b}{\kappa} f\left(\frac{V}{b}\right)$ units per second. Hence if v_a represents the net rise in potential which the plate A begins to experience immediately after it has been released from earth,

$$\frac{dv_a}{dt} = \frac{2\pi}{\kappa} \left\{ af\left(\frac{V}{a}\right) - bf\left(\frac{V}{b}\right) \right\}.$$

By an exactly similar process of reasoning, the alteration in the potential of the plate B will take place according to the relation

$$\frac{dv}{dt} = \frac{2\pi}{\kappa} \left\{ bf\left(\frac{V}{b}\right) - af\left(\frac{V}{a}\right) \right\}.$$

If A rises, B must fall at an equal rate; and it will further be observed that if in the expansion of $f(x)$ there are any terms of the form mx where m is a constant, these terms (which in fact correspond to the Ohm's law part of the current) contribute nothing to the alteration of the potential of the plates A or B.

In view of the fact that the plates have to be connected to an electrometer of appreciable capacity, it is necessary to consider how the quantity which the electrometer measures is related to the quantity v referred to above.

Suppose, for example, that the plate A is connected to the electrometer. Let δU_a be the alteration of potential and δq the quantity of electricity going into the electrometer in the time δt . The alteration of potential of the plate A is also δU_a , and is composed of two parts, the part $\frac{2\pi}{\kappa} \left\{ af\left(\frac{V}{a}\right) - bf\left(\frac{V}{b}\right) \right\} \delta t$ referred to above, and a part $-\frac{\delta q}{C_a}$, where C_a is the capacity of the plate A modified as it is by the presence of the plates B and C. There is a third part which we shall call p arising from the induced displacements on the plates C and B, and resulting from the edge effects. We shall not introduce this part into the formula, as it will rather complicate the expressions, and its effect can sufficiently well be discussed afterwards.

The rise of potential of the electrometer in the time δt is $\delta q/C_e$, where C_e is its capacity. Thus

$$\frac{\delta q}{C_e} = \frac{2\pi}{\kappa} \left\{ af \left(\frac{V}{a} \right) - bf \left(\frac{V}{b} \right) \right\} \delta t - \frac{\delta q}{C_a}.$$

Hence

$$\frac{\delta U_a}{\delta t} = \frac{1}{C_e} \frac{\delta q}{\delta t} = \frac{C_a}{C_a + C_e} \cdot \frac{2\pi}{\kappa} \left\{ af \left(\frac{V}{a} \right) - bf \left(\frac{V}{b} \right) \right\}. \quad (1)$$

Similarly we have for the plate B,

$$\frac{\delta U_b}{\delta t} = - \frac{C_b}{C_b + C_e} \cdot \frac{2\pi}{\kappa} \left\{ af \left(\frac{V}{a} \right) - bf \left(\frac{V}{b} \right) \right\}. \quad (2)$$

C_a and C_b are practically the same, so that we should have

$$\frac{\delta U_a}{\delta t} = - \frac{\delta U_b}{\delta t}.$$

C_a and C_b would be exactly the same except for the edge effects, which are nearly eliminated by the guard-ring arrangement, for the effect of an insulated plate on the capacity of another plate parallel to it should be independent of the distance between the plates, and should depend only on the thickness of the plates. The edge effects do play a slight part, however, for in any inductive action between C and A or B, the edge of the plate C takes so much more of its share of the displaced charge, so to speak, as to cause the effect to be the same as if C were connected to an external body of appreciable capacity. The net result is that C has a greater effect on the capacity of A which is near to it, than on B which is far away. The difference between C_a and C_b is, however, very slight. The quantities $\frac{C_a}{C_a + C_e}$ and $\frac{C_b}{C_b + C_e}$ were measured*, and were found to be in the

* One pole of a battery of two cadmium cells was connected to a quadrant of the electrometer through a very high resistance, the other pole being earthed, and observations of the movement of the needle were made. The experiment was then repeated with one of the capacities, C_a for example, connected to the quadrant. The ratio of the times taken by the electrometer-needle to move over the same range, gave the ratio $\frac{C_e}{C_a + C_e}$, and from this $\frac{C_a + C_e}{C_a}$ could be calculated.

This method of determining the ratio was found far more satisfactory than any other, such, for example, as the method of mixtures, since in it no errors can arise due to electrostatic effects arising at the instant of making contact between the two capacities concerned.

ratio 1.03 to unity. When allowance is made for the slight difference between these quantities, the curves for the two plates become even more exactly the images of each other.

Another factor which tends to destroy the exact equality between $\frac{\delta U_a}{\delta t}$ and $-\frac{\delta U_b}{\delta t}$ arises from the quantity p referred to above. This quantity arises mainly from the appreciable edge effect of the plate C. It results from a positive charge coming to the centre portion of the plate from the edges, owing to the fall in potential experienced by the plate, and caused by the electricity leaving it. The effect of the quantity p on the rise of potential of the electrometer is greater when the electrometer is connected to A than when it is connected to B, owing to the nearer proximity of the plate C in the first case, but the effect is a positive one in both cases, so that it acts in such a way as to increase the movement of the needle when the electrometer is connected to A, and to decrease the movement when the electrometer is connected to B. This provides another reason for the slight difference in the heights of the ordinates of the curves. The ratio of the corresponding ordinates of the two curves is practically constant.

The necessity for the equality in the alteration of potential of the two plates rests on the assumption that in virtue of the guard-rings, the plates act like infinite plates, so that the experiments justify this assumption very well. The point was well illustrated by some preliminary experiments, taken with a piece of apparatus in which the centre plate C was only equal in size to the plates A and B so that the guard-ring arrangement was imperfect. Here the stream lines were more nearly perpendicular to the plates between C and A, than between C and B. The effect was to increase the rate of rise of potential of the plate A owing to the diminution in the counteracting effect which was caused by the electricity going from C to B. The same effect caused a diminution in the fall of potential of the plate B, so that the ordinates of the curve for the plate B were less than the corresponding ordinates for plate A by 30 per cent.

The fact that in the experiments made with the final apparatus the curve for the plate A is so nearly an image of the curve for the plate B constitutes an important fact in favour of the experiments, because it shows that the alteration in the potentials of the plates, which should be zero if Ohm's law were obeyed, is to be attributed to a true departure

from that law, and not to some imperfection in the guard-ring arrangement, for on such a view there would be no reason for the exact similarity of the two curves. Again, the effects are not to be explained by any inductive action, caused by a lowering of the potential of the plate C due to a passage of electricity more rapidly from its edges than from other parts, or to a passage of electricity from the rod attached to the plate C, for such effects would result in a lowering of the potential of both plates.

Quite apart from the above considerations, it may be shown (though it is hardly necessary here to give the analysis), that if Ohm's law were obeyed, any alteration of the potential of the plates or of any part of the apparatus, for that matter, which could possibly arise due to imperfections of the guard-ring arrangement, would necessarily follow an exponential law with the time.

Now on referring to the curves in figs. 2 and 3, we find that they depart from the exponential form to a degree enormously greater than the possible limit of error in the

Fig. 4.

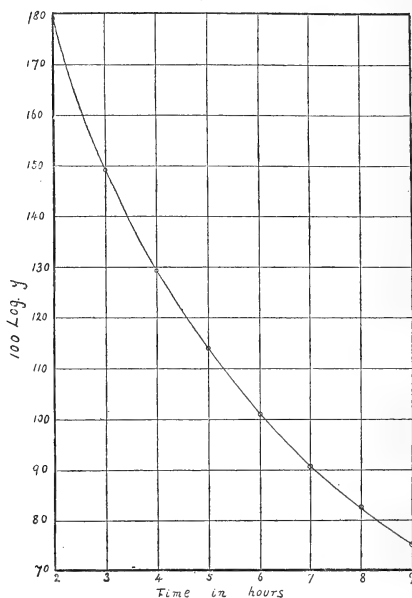

experiments, for if these curves are exponential curves they should lead to a linear relation between $\log y$ and t , where y is the ordinate. In fig. 4 $\log y$ is plotted against t , y being taken for each time as the mean of the corresponding

ordinates of the curves in fig. 2. It will be seen that the relation is very far from a linear one, and the deviation from the linear law is enormously greater than can be accounted for by errors of observation.

It is interesting to inquire as to the extent of the departure from Ohm's law. Applying equation (1) and putting in the measured value of $\frac{C_a}{C_a + C_e}$ and a , we find that corresponding to the first observation of the first table on p. 681,

$$f\left(\frac{V}{a}\right) - \frac{b}{a}f\left(\frac{V}{b}\right) = 1.07 \times 10^{-12} \text{ ampere per sq. cm.}$$

This is obtained taking κ as 2.3. If, as is probably the case, the effective value of κ is larger, the corresponding value of the above quantity would also be larger. Hence $f\left(\frac{V}{a}\right)$, which measures the current density between C and A, is greater than 1.07×10^{-12} . Taking 3×10^{18} as the specific resistance of paraffin-wax for small fields, we find, on the assumption of a linear law, that the part of the current density obeying Ohm's law comes out as 1.7×10^{-14} . This is taking the potential difference between C and A to be 10,000 volts, which is, if anything, too high, since this is approximately the potential to which C was originally charged. Thus the portion of the current which our apparatus records, and which does not obey Ohm's law, is for the above potential gradient (50,000 volts per centimetre) at least 60 times as great as the part not recorded by the apparatus, and calculated on the assumption of Ohm's law.

(3) *Reasons for the departure from Ohm's Law.*—We have already seen that the experiments are not to be explained as arising from a departure from Ohm's law such as would be accounted for by an approach to the condition where saturation currents are obtained. The bearings of the phenomena of residual charge on the matter are rather complicated, but we can see in a general way that it is very unlikely that the experiments can be explained by an appeal to these phenomena. We may consider dielectric strain of two kinds. In the first, the dielectric may be considered to be strained, and to be continually giving way permanently after the manner of a number of elastic threads which are stretched, and break one by one. There is nothing except the complication of the phenomenon, however, to distinguish this from true conduction, so that we need only concern

ourselves with the second kind of strain, viz., that kind of strain which releases itself on removal of the electric force.

When the centre plate is charged, there is a displacement of electricity in each volume element of the wax. If E is the total charge per cubic centimetre taking part in the displacement, and x and y the average separation of the corresponding positive and negative constituents of the volume elements between C and A and between C and B respectively, the lowering of the potential difference between C and A due to the displacement is $2\pi E x$. Similarly, the displacement in the wax between C and B results in a lowering of the potential difference between these plates, of $2\pi E y$. A portion of the displacements x and y follow the field immediately, and are responsible for the ordinary phenomenon of the existence of a specific inductive capacity greater than unity. In most dielectrics a portion occurs only after an interval after the change of field. Let us consider the first portion. As the potential of C falls, owing to conduction of electricity across the wax, these displacements diminish. If δx and δy are the diminutions for a fall δV in the potential of C, the fall of A (supposed insulated), due to this cause is

$$\Delta V = 2\pi E a \delta x - 2\pi E b \delta y.$$

If the strain is proportional to the potential gradient $a\delta x = b\delta y$ and ΔV is zero. Any departure from a linear relationship between the strain and the potential gradient would be expected to be such as to make the strain increase more rapidly with the field than would be accounted for by a first power law, which would result in ΔV being the negative instead of positive as was found.

Considering the possibility of the existence of a portion of the strain showing a hysteresis effect*, we may remark that the probability of the effect being of importance in the present experiments is small, since the curves of fig. 2 fit those of fig. 3 almost exactly when superposed (although the plate C started at entirely different potentials in the two experiments), which is a fact difficult to explain on the assumption that the results are due to hysteresis, unless one makes certain special assumptions with regard to the lag.

* It may be remarked that H. A. Wilson (Proc. Roy. Soc. vol. lxxxii. 1909) finds that paraffin-wax shows no hysteresis effect, though of course his results apply to much smaller potential gradients than those here used.

Quite apart from this, however, if the fact that the potential of A starts to rise when A is released from earth is to be explained in any way as due to recovery from strain, such a rise during part of the experiment can only be accounted for by allowing that during another period of the experiment there would be a corresponding fall; at least, this is so unless we make the very unlikely assumption that the ratio of the steady displacements between C and A to that between C and B is less than the ratio of the corresponding fields. A condition in which A fell in potential when C was positively charged was never found to occur, and we can only imagine the possibility of its occurrence by relegating it, together with the period of transition, to the few minutes which elapsed between charging the plate C and taking the first observations. Somewhat similar arguments to the above may be applied to show that it is very unlikely that the present results are due to the fact that ions do not remain uniformly distributed between the plates, and that an appreciable time is taken by them in attaining a steady state.

The first idea which these experiments suggest, is that of an ionization increasing with the field, and it is at any rate worth inquiring as to how far this phenomenon is capable of providing an explanation of the observed effects. It turns out, however, that since the mean free path of an electron in a solid is probably not greater than 10^{-7} cm., the energy given by the field to an electron while it is travelling over its mean free path, is, even in the case of a field of 50,000 volts per cm., only equivalent to the energy obtained in a fall through 0.005 volt, and this is far too small to enable the electron to ionize.

A simple estimation will show that any fields which we can produce would be far too small to tear an atom to pieces, or in fact to be of any appreciable importance in this respect compared with the effects due to the atoms on each other; and we are led to look for an explanation of the phenomenon as resulting from a development for strong fields of that particular theory of corpuscular conduction which attributes the conductivity of metals as due to a polarization of the medium, resulting in corpuscles being emitted more copiously in a direction opposite to that of the field than in any other direction, the corpuscle after emission being immediately drawn into the atom which has been responsible for pulling it out (see 'Corpuscular Theory of Matter,' J. J. Thomson, p. 86). If, following Thomson, we assume that the number of corpuscles whose axes make an

angle between θ and $\theta + d\theta$ with the direction of the field is given by

$$dn = \epsilon \frac{3Xed}{mc^2} \cos \theta \sin \theta d\theta,$$

where e is the electronic charge, d is the distance between the constituents of a doublet, X is the field, and c^2 is the mean value of the square of the velocity of the molecule, the average value of $\cos \theta$ is given by $\overline{\cos \theta}$ where

$$\overline{\cos \theta} \int_0^\pi \epsilon \frac{3Xed}{mc^2} \cos \theta \sin \theta d\theta = \int_0^\pi \epsilon \frac{3Xed}{mc^2} \cos \theta \sin \theta d\theta.$$

When $\frac{Xed}{mc^2}$ is very small, $\overline{\cos \theta}$ reduces to $\frac{Xed}{mc^2}$, and the usual view taken is that the effect is the same as if $\frac{Xed}{mc^2}$

doublets emitted a corpuscle p times per second in the direction of the field, where p is the number of corpuscles emitted by an atom per second without regard to direction.

Denoting $\frac{3Xed}{mc^2}$ by r , if squares, and cubes of r are not negligible, $\overline{\cos \theta}$ comes out as $\frac{\epsilon^r + \epsilon^{-r}}{\epsilon^r - \epsilon^{-r}} - \frac{1}{r}$, which reduces to $\frac{1}{3} \left(r - \frac{1}{24} r^3 + \dots \right)$. In our experiments, however, r is only of the order 0.01, so that the second term is quite inappreciable compared with the first. If this had not been so, the theory would have predicted an effect in our experiments the reverse of that which was found; *i. e.*, when the plate C was charged positively the plate A would have shown a fall of potential with time as the electricity passed across, for it will be remembered that the apparatus does not detect the part of the current which obeys Ohm's law. Thus the above simple form of the theory does not give any suggestion of a departure from Ohm's law for the fields used. It must be admitted, however, that the application of the Boltzmann law in the above form to the present problem is a very bold one, for in view of the close proximity of the atoms, the internal coordinates must play an important part. Further, the potential energy of the system must depend not only on the orientation of the doublets with respect to the field, but largely on their orientation with respect to each other. In fact, it would seem that we might be nearer the truth if we were to assume that the orientation of the molecular doublets followed a law, analogous in its relation to the field, to the law followed by the molecular magnets which represent the atoms of a piece of iron, when the iron is subjected to a magnetizing field.

On this view, as the field is increased, the average value of $\cos \theta$, and consequently of the current, might be expected to increase at first in proportion to the field. As the field was further increased, $\cos \theta$ might be expected to vary more rapidly with the field than is required by Ohm's law, and in a manner such as our experiments suggest, finally attaining saturation for extremely large fields. The quantity p representing the rate of expulsion of electrons from the atoms would also vary with the field, because as the doublet axes become more and more parallel to the field, they become more favourably situated in respect to each other for the purpose of pulling out corpuscles.

It may be remarked, that if the above theory were true, we should expect a variation of the specific inductive capacity with the field. The fact that the value of the specific inductive capacity between plates A and C would be greater than that between B and C would tend to diminish the rise in potential of the plate A, and the fall of potential of B, but it is easy to see that this effect does not completely counteract nor reverse the alteration in potentials of the plates.

Summary.

(1) Experiments for obtaining information with regard to the current potential curve for a very good insulator are described, the method being of a new type designed to avoid difficulties due to the high potentials used, and to bring into prominence any deviation from Ohm's law.

(2) The theory and possibilities of error due to a departure from the ideal conditions of the simple theory are fully considered, and it is shown that the only likely way of accounting for the results obtained is by the assumption of a departure from Ohm's law such as corresponds to an increase of the conductivity with the field.

(3) The reasons for discarding any explanation of the phenomenon as due to soakage are discussed, and the possibility of its explanation as the result of an increase in the ionization, due to the field, is examined and found untenable.

Other methods of accounting for the phenomenon are also discussed, the most likely one being framed on the lines of a modification of the theory of metallic conduction proposed by Sir J. J. Thomson.

The Physical Laboratory,
University of Sheffield,
April 21st, 1913.

LVI. *On the Effect of Pressure on the Electric Wind from a Discharging Point.* By J. R. BOON, B.Sc.*

THE pressure of the electric wind from a discharging point in various gases has been measured by Chattock †, Chattock and Tyndall ‡, and Tyndall §.

Thus it has been shown by Chattock for various gases, and later by Chattock and Tyndall for mixtures of hydrogen and oxygen, that if a point is placed opposite a plane at a distance z from it, the average pressure on the plane, p , for a given current density is a linear function of z when the values of the latter are of the order of a few centimetres. This is in accordance with the theoretical deductions based on the assumptions that the ions move viscously and that the discharge is a one-way discharge. If, however, the experimental values of p and z are plotted and the line is produced to $p=0$, it cuts the axis of z at some positive value, referred to in what follows as z_0 .

For negative discharge in "pure" hydrogen z_0 was as much as 4 centimetres, but it rapidly decreased to 3 or 4 millimetres on the addition of small percentages of oxygen or air. For positive discharge under the same conditions it was 3 or 4 millimetres throughout. In air z_0 was found to have about the same value, 4 millimetres, for both signs of discharge. Later, Tyndall showed that the distance z_0 was independent of the current and of the size of the point.

The simplest explanation of the existence of z_0 is that through a certain portion of the distance between point and plane the discharge is either wholly or partially non-wind-producing; the later experiments seemed to locate this region near the point. In order to obtain further experimental data the author has made measurements of the value of z_0 at different pressures and in different gases. From the results some definite conclusions may be drawn, and these are set down below.

Apparatus.

The main experimental difficulty is the construction of a gauge of high sensitiveness to measure the small differences of pressure involved. The Chattock-Fry gauge, which had been

* Communicated by Dr. A. M. Tyndall.

† Chattock, *Phil. Mag.* [5] xlviii. p. 401.

‡ Chattock & Tyndall, *Phil. Mag.* [6] xix. p. 449.

§ Tyndall, *Phil. Mag.* [6] xxi. p. 585.

used in previous experiments to measure the wind-pressure, is not suitable for work at different atmospheric pressures, since it requires a somewhat cumbersome mercury trap to prevent the boiling of the liquid indicator under reduced pressure. For the final experiments, after various trials, the recently described Fry micromanometer* was set up.

This gauge consists of two compartments separated by a diaphragm. When a difference of pressure is put on between the compartments a movement of the diaphragm results, and is shown by the movement of a spot of light reflected from a mirror suspended in a special manner. The details of construction and calibration are given in full in the original

Fig. 1.

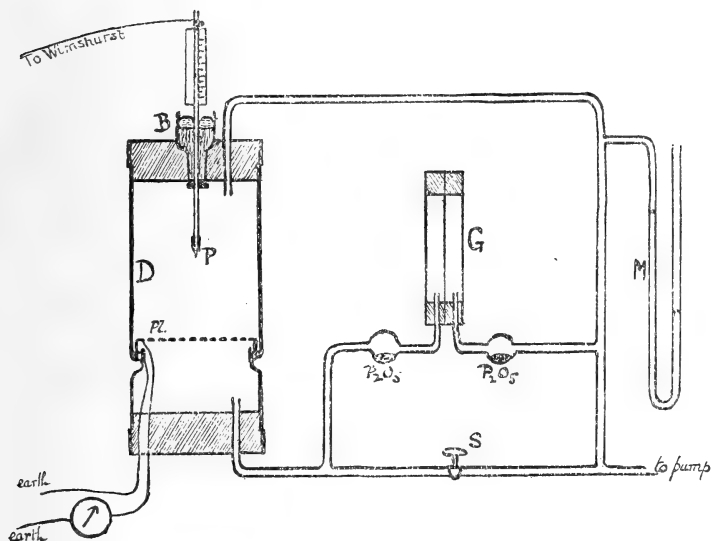

paper. Gauges of this type have been constructed to indicate a pressure of $\cdot 001$ dyne per sq. cm., though it was not necessary to use such a sensitive form in the present work. The actual pressures measured ranged from $\cdot 06$ to $1\cdot 2$ dynes per sq. cm.

The discharge-tube D (fig. 1) was of glass and was closed top and bottom with insulating stoppers. The compartments above and below the plane were connected by glass tubes to the two sides of the gauge. Drying-tubes and a manometer M

* Phil. Mag. April 1913.

were introduced as shown in the diagram. A wide short-circuiting tap S also joined the two sides of the gauge, for use when the apparatus was being pumped out. The discharge-tube was made air-tight with picein. The discharging point P was sheathed almost to its end with glass and was supported by a thin steel rod sliding in a mercury-tight stuffing-box, B, which fitted into the insulating ebonite plug.

Round the edge of the plane, but insulated from it, and supported by a slight constriction in the tube, was an earthed mercury trough. This was introduced to catch any current due to discharge down the sides of the glass which, if it found its way to the plane, would contribute to the total current but not to the wind.

To measure z_0 accurately the original form of ring electrode used by Chattock is not suitable, as it is not possible with this to measure z accurately, though differences in z can be measured. An attempt was made to replace this by a plane consisting of a series of layers of the finest mesh copper gauze, but it was found that the flow of gas through this was not viscous, and that consequently the pressure indicated by the gauge was not the average pressure of the wind on the plane. As in the later work of Chattock and Tyndall, a plate was finally made from a sheet of zinc by perforating it with fine holes by means of a needle. It is necessary in such a plate that the perforations should be all equal and equally spaced, and that the flow of gas (if any) through the plate should be proportional to the difference of pressure producing it. The differences of pressure produced on the two sides of the plate were so small that this last condition was approximately fulfilled. The plate P1 was connected through a galvanometer to earth, as shown in the figure.

Results.

The measurements of wind-pressure p and distance between electrodes z for a constant current have been carried out in air and in CO_2 over a range of atmospheric pressure from 76 cm. to 20 cm., and the results are collected in the Curves I., II., and III. (pp. 697, 698).

Curves I. and II. show some typical p and z results, the actual results plotted being those for negative and positive discharge in air for a current of 1.24×10^{-6} amp. (Different scales of p are used for convenience of arrangement.) From such curves as these the values of z_0 can be read off at different atmospheric pressures II.

In all cases investigated the result obtained was that, for a given sign of discharge and a given gas, z_0 is inversely proportional to Π , the atmospheric pressure. This is shown

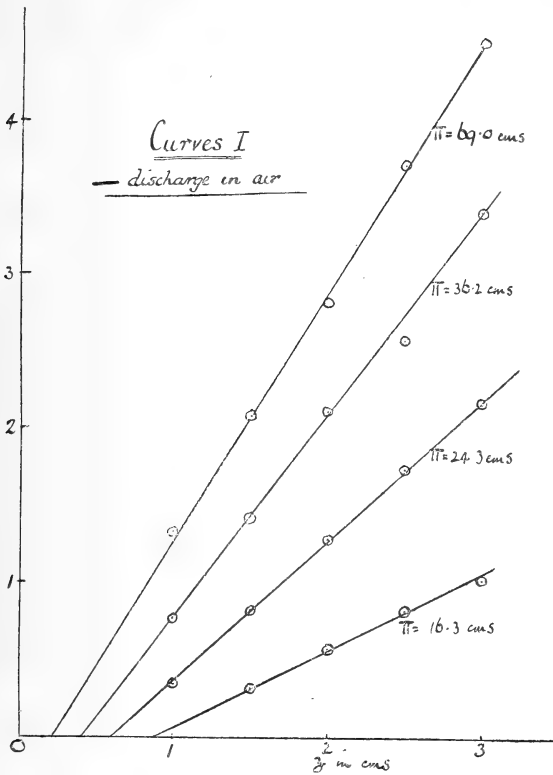

clearly in the Curves III. in which z_0 is plotted with $1/\Pi$; in these it will be seen that the experimental points for air lie very closely on a straight line through the origin. For CO_2 only negative discharge values are plotted and these, though not quite so good, seem to follow the same law.

There are apparent exceptions however, a few of which are shown in the Curves III. Thus in positive discharge in air the point for $1/\Pi = \cdot 039$ is quite off the line, as also are the points for $1/\Pi = \cdot 072$ and $1/\Pi = \cdot 066$ in negative discharge in air, and the point for $1/\Pi = \cdot 030$ in negative discharge in CO_2 . The values of z_0 in positive discharge in CO_2 do not fit on a line at all and were exceedingly irregular. All these exceptions are, however, quite easily explained.

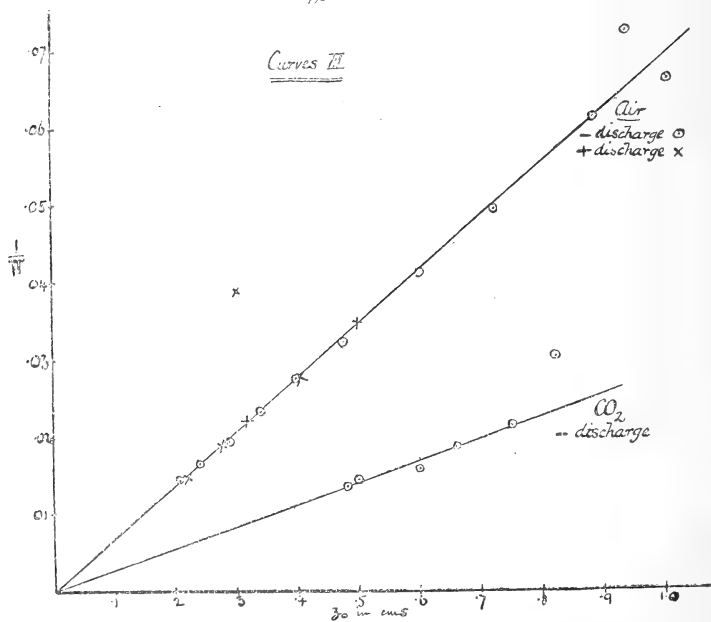
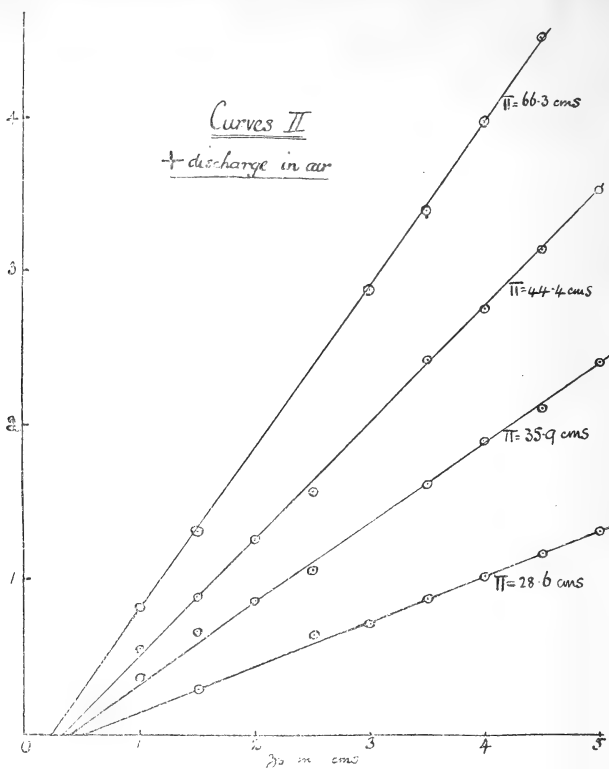

They are due to an effect which is undoubtedly present in all cases at still lower pressures and which prevents the extension of the experiments to low atmospheric pressures. The linear relationship between p and z only holds if the proportion of current carried by discharge (if any) from the plate does not alter as z is altered. At low pressures back discharge is considerable and appears to increase with z . This has the effect of giving the line too small a slope and too small a value for z_0 . In every case in which these low readings were observed it was found that the discharge was luminous when viewed in the dark. This effect seems to set in more readily with positive discharge than with negative; thus no readings in positive discharge below $\Pi = 28$ cm. could be obtained without it. In CO_2 it seemed to be present at all pressures in the case of positive discharge, and no values of z_0 to which any meaning could be attached were obtained.

The values of z_0 obtained at atmospheric pressure in air were practically the same for both signs of discharge, a result previously obtained by Tyndall; the actual values, $\cdot 19$ cm. and $\cdot 195$ cm. for positive and negative discharge respectively, are however smaller than his values. This may be due to the fact that in his work the point was sheathed more closely to the end, thus tending to make the glow at the point more of a brush in form. The value of z_0 at atmospheric pressure in CO_2 was $\cdot 46$ cm., which is considerably greater than that in air.

The results given below supply some further information. Thus Table I. shows the ratio (r) of the slopes of the wind-pressure-distance curves for positive and negative discharge at different atmospheric pressures Π .

TABLE I.

Π .	r .
75.5	1.25
65.9	1.25
63.9	1.24
56.7	1.22
50.1	1.26
39.4	1.25

It will be seen that r is practically constant. This is in agreement with the well-known fact that within these limits of pressure the velocities of the ions are inversely proportional

to the pressure, and consequently the wind-pressure slopes in both signs of discharge are altered in the same ratio.

It would seem that a further check on the results might be obtained by comparing the slopes $\frac{dp}{dz}$ for a given sign at different atmospheric pressures. Neglecting the effect of any back discharge which may be present, $\frac{dp}{dz}$ for a given sign should be proportional to Π since it is inversely proportional to the specific velocity of the ions.

Unfortunately, the pressure-gauge and its calibrator, in the particular form in which they were set up, were not designed for *absolute* measurements of pressure-difference at atmospheric pressures far removed from normal; and in the sensitive form in which the gauge had to be used, strains set up in its framework at lower pressures would introduce a change in constant. The change in constant could not be estimated, and to obtain the absolute values of wind-pressure, at other than normal atmospheric pressure, the scale deflexions would have to be multiplied by some unknown constant depending on the value of Π .

Conclusions.

Several views may be put forward to explain the z_0 phenomenon.

(1) The ion may not be fully formed on leaving the point and may travel a small distance before completely clustering; z_0 may be taken as a measure of this distance. On this view the distance travelled by an unclustered ion would be probably jointly dependent on the field and on the number of collisions in a given time. Thus if F = field at the point where complete clustering occurs and Π = pressure in apparatus, z_0 would be a function of F/Π . Now not only does the field diverge rapidly from the point but it also varies according to a complex law with pressure. Owing to this and to the absence of experimental data or of any satisfactory theory of the motion of the ions in very strong fields, it is impossible to say what form the function would take. One would certainly not, however, expect such a simple relationship between z_0 and Π as experiment gives.

(2) In the strong fields near the point an ion may not move viscously, and may not therefore exert its full drag on the gas. The same remarks as to lack of data or theory apply also in this case, and one cannot, therefore, completely dismiss this as an explanation. The simplicity of the experimental results again seems to render this explanation decidedly improbable.

(3) The simplest explanation is that this z_0 region is one of considerable ionization extending far beyond the limits of the glow. This ionization may be brought about by collisions between molecules and ions or other bodies proceeding from the glow, or by the emission of certain radiations, possibly some intense form of Entladungstrahlen, from the glow at the point. In the latter case z_0 might be independent of the field F , in that it would be merely a measure of the path of these radiations before absorption. Such radiations would probably be independent of the distribution of the electric field and would be absorbed according to a density law, and therefore in a distance inversely proportional to Π . The experimental evidence is thus in favour of this view, although it throws no light on the exact nature of this radiation. The radiation would have to be of an extremely intense nature because one is dealing with the wind effects of a current which is many times greater than the ordinary ionization currents at high pressures.

The values of z_0 in air and CO_2 are $\cdot 2$ cm. and $\cdot 46$ cm. respectively. Thus, although z_0 is inversely proportional to density in a given gas, there is no such simple relation when its values are compared in different gases. If, therefore, z_0 is brought about by radiations from the glow at the point, the penetrating power of these radiations must depend upon the gas in which they are produced.

Summary.

1. An improved apparatus for the measurement of the pressure of the electric wind from point-plate discharge under different atmospheric pressures has been set up.

2. The curves of wind-pressure p and distance between the electrodes z agree in form at normal atmospheric pressure with those of other observers and cut the z axis at a distance z_0 from the origin.

3. The results at different atmospheric pressures Π , in air and CO_2 , show that z_0 is proportional to $1/\Pi$. This supports the view that z_0 is the result of intense ionization possibly brought about by radiations from the point, which are absorbed in a given gas according to a density law.

The above experiments were carried out in the Physical Laboratories of the University of Bristol.

My thanks are due to Dr. A. M. Tyndall for kindly suggesting the research, and for constant advice during the course of the work, and to Mr. J. D. Fry for help in setting up the pressure-gauge.

LVII. *Scattering of α Particles by Gases.* By Professor E. RUTHERFORD, *F.R.S.*, and J. M. NUTTALL, *M.Sc.**

THE scattering of α particles by matter has been examined in detail by the scintillation method by Geiger † and by Geiger and Marsden ‡. In the experiments of Geiger, the most probable angle through which an α particle was scattered was determined by the scintillation method for different thicknesses of a number of elements. It was found that the most probable angle of scattering for thicknesses of different elements, equivalent in stopping power of the α particle to one centimetre of air, was proportional to the atomic weight of the scattering element. A systematic investigation was later made by Geiger and Marsden of the "large angle scattering" by thin films of matter. The results were shown to be in complete accordance with the theory of "single" scattering advanced by Rutherford §. This theory supposes that the atom consists of a charged nucleus surrounded by a compensating distribution of electrons. The large angle scattering is due to the passage of the α particle through the intense electric field of the nucleus. It was deduced by Rutherford, and Geiger and Marsden, that the charge on the nucleus for atoms between carbon and gold was approximately proportional to the atomic weight, and was equal to $\frac{1}{2}Ae$, where A is the atomic weight in terms of that of hydrogen and e is the electronic charge. On this theory it is to be anticipated that hydrogen has a nucleus of one charge, helium of two, and carbon of about six.

As this deduction is of great importance in connexion with the constitution of the simpler atoms, experiments were undertaken to determine the scattering of α particles by the simple gases. The method employed by Geiger and Marsden for solids is not altogether suitable for gases; in addition, the large angle scattering to be expected for the light elements is exceedingly small, and would be difficult to measure with accuracy.

In some preliminary experiments, the α particles were made to pass between two parallel plates, placed a small distance apart, and the number of issuing particles were observed (1) in a vacuum and (2) when the space between the plates was filled with gas at a known pressure. The number of α particles was counted photographically, using a string electrometer. On account, however, of the probability

* Communicated by the Authors.

† H. Geiger, *Proc. Roy. Soc.* lxxxi. p. 174 (1908).

‡ H. Geiger and E. Marsden, *Phil. Mag.* xxv. p. 604 (1913).

§ E. Rutherford, *Phil. Mag.* xxi. p. 669 (1911).

variations, a very large number would have to be counted in order to obtain a reliable result. This would involve much time and labour, and it was consequently felt desirable to use a more indirect but rapid method.

The experimental arrangement finally adopted is shown in fig. 1. A narrow pencil of α particles was obtained by placing

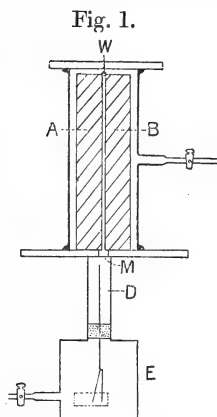

a thin platinum wire *W* (see fig. 1), coated with radium *C*, between two thick glass plates *A* and *B*, 14.5 cm. long and 2 cm. in width, and kept about 0.3 mm. apart by mica stops. After traversing the space between the glass plates, the beam passed through a mica window *M*, of stopping power equivalent to 1.9 cm. of air, and then into an ionization chamber *D*, consisting essentially of three parallel equidistant brass plates 5 cm. long and 3 cm. wide, 7 mm. apart. The outer plates were earthed and the central one insulated and connected to the gold-leaf system of an electroscopical system *E*. The latter was kept exhausted in order to diminish the ionization due to β and γ rays. The upper part of the apparatus, consisting of a cylindrical glass tube (with ground-glass ends) containing the plates *A* and *B* and the source of α rays *W*, could be completely exhausted and filled with any gas or vapour to any desired pressure, measured in the usual way by a mercury gauge. It was necessary to employ a strong source of α particles, and this was obtained by exposing about one centimetre length of thin platinum wire 0.2 mm. diameter to radium emanation for three hours as cathode in an electric field. A short time after removal from the emanation, radium *C* is the only α -ray product remaining on the wire, and since its curve of decay is accurately known, the amount of radium *C* present at any subsequent time can be readily calculated. Care was taken to remove any traces

of emanation from the wire by washing it in absolute alcohol and heating it slightly.

The method of procedure in an experiment was as follows. An active wire was placed in position between the glass plates AB and the upper part of the apparatus was exhausted. The source W emitted a pencil of homogeneous α particles which passed through the mica window M, and the ionization they produced in chamber D was measured in the electroscope E. The whole issuing beam of α rays was completely absorbed in the chamber D, and the ionization due to β and γ rays was never more than 2 per cent. of the whole effect. If a gas is now introduced into the upper chamber, *i. e.* between the plates A and B, and the ionization current again measured, any decrease, when correction is made for decay of source, will be due either to partial absorption of α particles by the gas in the upper chamber or to the scattering of α particles against the faces of the plates resulting in a diminution in the number entering the ionization chamber. The decrease of ionization due to loss of range by absorption was measured in a separate experiment. For this purpose the plates AB forming the long narrow slit were removed, and the ionization current measured for various pressures of gas in the upper cylinder, the source W

Fig. 2.

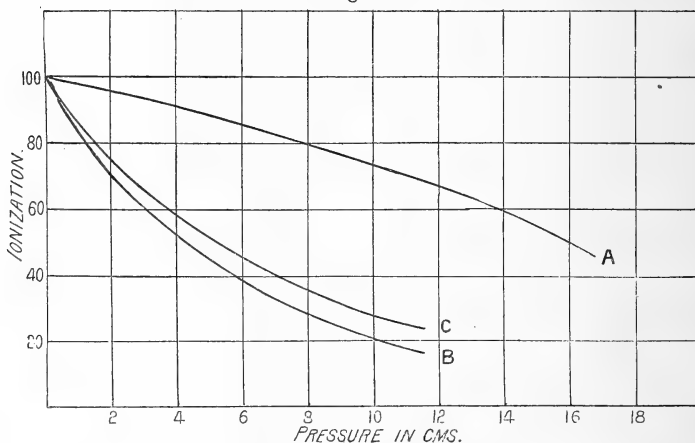

being placed in exactly the same position as before. In this way a curve can be obtained showing the relation between the pressure of the gas in the upper cylinder and the ionization produced by the source in the chamber D. A typical curve is shown in the curve A of fig. 2*.

* Compare H. L. Bronson, Phil. Mag. xi. p. 806 (1906).

In the same figure, curve B gives the result of a typical experiment showing the effect of both scattering and absorption together. From the two curves A and B, a curve can be obtained which gives the effect of scattering alone. To obtain this, the ratios of the ordinates of the curves A and B at each pressure must be plotted. It is obvious that this ratio gives the fraction of α particles scattered by the gas at each particular pressure, and is independent of any change of ionization due to loss of range. Curve C obtained in this way indicates the amount of unscattered radiation passing between the plates at various pressures. It is seen that, over a certain range of the α particle at least, the amount of unscattered radiation passing between the plates varies nearly exponentially with the pressure of gas, *i. e.* if N_0 is the number of α particles at zero pressure and N_p the number at pressure p cm., then $N_p/N_0 = e^{-\lambda p}$, where λ may be called the "scattering coefficient" for the particular gas under the given conditions. It should be noted that this formula does not hold accurately when the pressure of the gas becomes so large that the velocity of the α particle is much reduced. For pressures of the gas, whereby the loss of range of the α particle is equivalent to more than 2 cm. of air at atmospheric pressure, the scattering will increase more rapidly. Indications of this were obtained in some of the experiments. Table I. gives the results of a typical experiment, air being used as the scattering gas.

TABLE I.

Pressure of Gas p .	Scattering and absorption.	Absorption alone.	Intensity N due to scattering alone.	$\frac{\log N_0/N_p}{p}$.
0 cm.	100	100	100	
·92	84·2	98·2	86·8	·66
1·9	72·6	96·5	75·2	·65
3·55	58·0	93·0	62·5	·58
5·10	45·9	88·6	51·9	·56
7·15	33·5	82·5	40·6	·55
9·00	24·6	76·5	32·0	·55

The numbers in the last column show that the radiation is scattered approximately according to an exponential law over a considerable range of pressure.

Variation of scattering with the distance between the plates.

A few experiments were made to determine approximately the variation of scattering with the distance between the plates. The latter distance was varied from $\cdot 173$ mm. to $\cdot 89$ mm.; the corresponding least angles of scattering to deflect the α particles against the faces of the plates varying from $0^{\circ}\cdot 069$ to $0^{\circ}\cdot 356$.

The collected results are shown in Table II. The relative scattering coefficients are compared by observing from the curves the pressure of gas required to scatter 50 per cent. of the initial number of α particles.

TABLE II.

Distance d apart of plates.	Relative scattering coefficient λ .	$\lambda \cdot d^{5/4}$.
$\cdot 172$ mm.	$\cdot 562$	$\cdot 618$
$\cdot 325$	$\cdot 256$	$\cdot 627$
$\cdot 586$	$\cdot 126$	$\cdot 643$
$\cdot 890$	$\cdot 0712$	$\cdot 615$

Within the limits employed, the scattering appears to vary rather more rapidly than the inverse of the linear distance d between the plates and to be nearly proportional to $d^{-5/4}$.

It will be shown later that the scattering coefficient increases rapidly with decrease of velocity of the α particle. A correction has consequently to be applied to reduce the amount of scattering to a standard velocity. This correction has been made in the results of Table II.

Variation of scattering with atomic weight.

The gases whose scattering coefficients were compared were as follows:—air, hydrogen, helium, methane, carbon dioxide, and sulphuretted hydrogen. A few experiments were made on the scattering produced by the heavy vapours, methyl iodide and ethyl bromide, but they are not included in this paper. In all cases two sets of experiments were performed: (1) experiments on the scattering and absorption combined, and (2) experiments on the absorption alone. The latter were in agreement with the stopping powers of the gases as calculated by Bragg's* square-root law.

The distance between the plates was kept constant during

* W. H. Bragg, Phil. Mag. x. p. 318 (1905).

the course of these experiments, and the scattering of each gas was compared with air as a standard. The scattering curve for air, which was repeated before and after each experiment, was found to be unchanged throughout the investigation. The logarithmic curves for the different gases are shown in fig. 3. The pressures of gas are plotted as

Fig. 3.

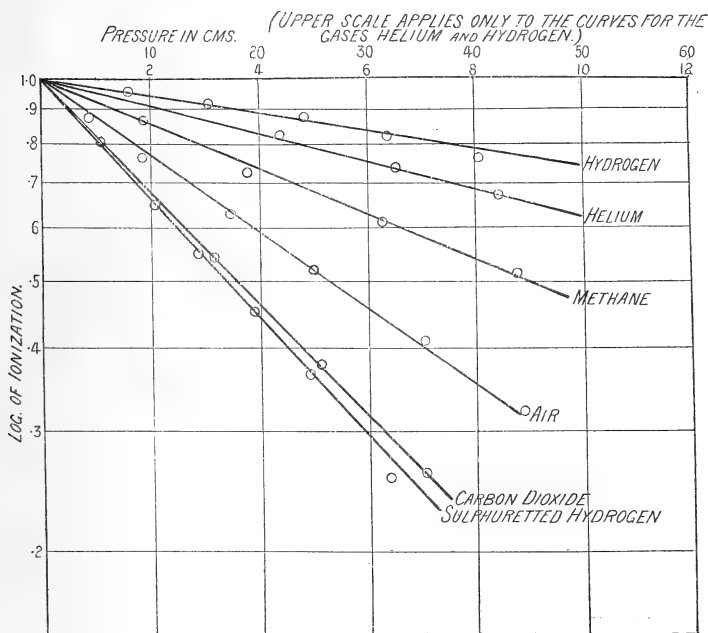

abscissæ, and the logarithms of the intensity of the unscattered radiation passing between the plates as ordinates.

A few details of the method of preparation and purification of the gases are given.

Hydrogen. This was prepared electrolytically and dried carefully. It contained about 1 per cent. of impurity, chiefly oxygen. A correction was made for this in the curve of fig. 3, which is the mean of several experiments.

Helium. The helium was purified by passing over charcoal immersed in liquid air. This removed all traces of air and other impurities, except possibly the last traces of hydrogen.

Methane. This was prepared by acting on aluminium carbide with water and passing through cuprous sulphate to remove the acetylene. The resulting impure methane was condensed by liquid air, and pure methane obtained by fractional distillation.

Carbon dioxide was obtained from a cylinder of compressed gas, which on analysis was found to be of 99·7 per cent. purity.

Sulphuretted hydrogen was prepared by action of sulphuric acid on calcium sulphide. It was analysed and found to be of 99·8 per cent. purity.

From the results obtained in these experiments, the relative atomic coefficients of scattering were deduced for hydrogen, helium, carbon, air, oxygen, and sulphur. In the case of complex molecules, it was assumed that the scattering coefficient of the molecule was the sum of the values for each of its individual components. For example, the coefficient for carbon was deduced from the value of methane (CH_4) by subtracting from the observed value the scattering coefficient due to four atoms of hydrogen. In a similar way, the value for oxygen was deduced from CO_2 and sulphur from H_2S . A correction was required in each case to allow for the variation of scattering with velocity of the α particle. The reduction in velocity of the α particle in passing through a sufficient pressure of gas to scatter half the α particles was deduced from the loss of range of the α particle in the gas, using the relation between velocity and range found by Geiger. In making this correction it was assumed, as will

TABLE III.

Gas.	Corrected pressure to scatter half of incident radiation.	Relative scattering coefficient.	Atomic weight.	Remarks.
Air	5·32 cm.	1·00	14·4	Diatomic.
Carbon (from CH_4).	13·32 „	·40	12·0	Monatomic.
Carbon dioxide	3·64 „			
Oxygen	5·00 „	1·064	15·99	Diatomic.
Sulphur	3·36 „	1·61	32·0	Monatomic.
Hydrogen*	46·3 „	·0353	1·0	Diatomic.
Helium*	26·2 „	·064	3·99	Monatomic.

* In the cases of hydrogen and helium the pressures given are those required to cut down the incident radiation to 80 per cent. of its initial value, and they are compared with the pressure of air required to scatter to the same extent, viz. 1·68 cm. of mercury.

be seen later, that the scattering coefficient varied inversely as the fourth power of the velocity. In practice, the value of the pressure was corrected so as to give the scattering observed, assuming that the velocity was equal throughout to the initial value for the α particle.

Variation of scattering with velocity.

Geiger found that the most probable angle of scattering of α particles by solid matter increased rapidly with decrease of velocity of the α particle. This also holds for light gases. The initial velocity of the α particle was diminished by placing a sheet of aluminium foil of known stopping power under the active wire. The results are shown in fig. 4,

Fig. 4.

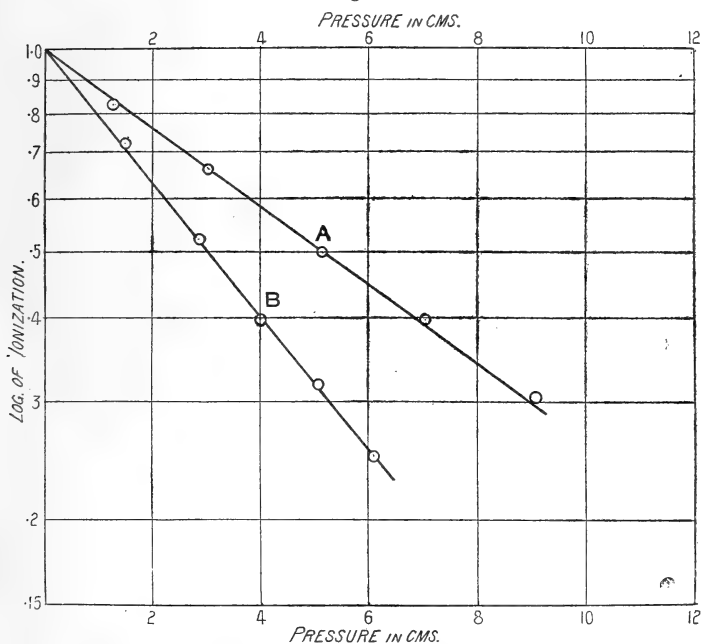

where the logarithm of the corrected ionization in the testing vessel is plotted as ordinates and pressures as abscissæ. In curve A, the initial velocity was the maximum velocity of α particles from radium C, whilst in curve B the initial velocity was .893 of the maximum velocity. The scattering coefficients observed in the two cases were in the ratio 1 : 1.66. The scattering thus varied approximately as the

inverse fourth power of the velocity. This is the law of scattering with velocity found by Geiger and Marsden in their experiments on "single" scattering.

Consideration of the Results.

In drawing deductions from these experiments, it is of importance to decide whether the scattering coefficient observed is to be ascribed to "single" or "compound" scattering. If the reduction in the number of α particles in passing between the glass plates is due mainly to "single" scattering, we should expect the scattering to vary directly as the pressure of the gas and inversely as the fourth power of the velocity—results observed experimentally. On the other hand, if the reduction in number is due mainly to "compound" scattering, we should expect that the scattering should be proportional to the square root of the pressure, and to vary as the inverse square of the velocity. It is thus clear from the experiments that the scattering coefficient observed is a consequence mainly of "single" scattering. This conclusion is still further strengthened by the rapid variation of the scattering with atomic weight between carbon and sulphur. No doubt "compound" scattering produces some effect, but the main part of the scattering is to be ascribed to the scattering of individual atoms resulting from the passage of the α particle through the intense field close to the electrons and the nucleus. If we consider the atom to be composed of a nucleus with a charge ne and a compensating distribution of n electrons, the scattering due to the n electrons is proportional to n , and the scattering due to the nucleus is proportional to n^2 . Mr. C. Darwin kindly examined this question mathematically for us, and concluded that if the electrons and the nucleus were a sufficient distance apart so as not to interfere seriously with the electric fields close to them, the scattering for simple atoms should be proportional to $n + n^2$ or $n(n + 1)$, where ne is the charge on the atomic nucleus. For deflexions through a small angle, such as are involved in the experimental arrangement employed in this paper, we should expect the scattering in the heavy atoms to be proportional to $n + kn^2$, where k is less than unity. This is borne out by the fact that under the experimental conditions the scattering due to heavy atoms like bromine and iodine was found to be less than the theoretical values when k is taken as unity. Assuming the simple formula found by Darwin as applicable to light atoms, the scattering coefficient λ is proportional to $n(n + 1)$ or $\lambda = cn(n + 1)$, where c is a constant.

It should be noted that Geiger and Marsden found that the "single" scattering per atom was proportional to the square of the atomic weight. This undoubtedly holds in the case of heavy elements for large angles of scattering, where the α particle passes close to the nucleus. It is a different matter, however, when the scattering angle is only about 1/10 of a degree, as in the present experiment. It is to be anticipated that under such conditions this simple law would be widely departed from, especially in the case of heavy atoms for which the number of electrons is large.

The following table gives the observed and calculated scattering coefficient for an *atom* of each of the elements examined. The value of n , the number of electronic charges assumed for the nucleus, is given in the second column. For a comparison of the calculated with the experimental values, carbon is assumed in both to have a scattering coefficient of $\cdot 40$ on the arbitrary scale. The scattering coefficient for nitrogen is deduced on the assumption that air is composed of 80 per cent. of N with 20 per cent. of O.

Gas.	Assumed value of n .	Relative scattering per atom.	
		Calculated values.	Experimental values.
H atom ...	1	$\cdot 0190$	$\cdot 0176$
He ,, ...	2	$\cdot 057$	$\cdot 064$
C ,, ...	6	$\cdot 40$	$\cdot 40$
N ,, ...	7	$\cdot 53$	$\cdot 48$
O ,, ...	8	$\cdot 69$	$\cdot 53$
S ,, ...	16	2.58	1.61

Considering the difficulty of determining with accuracy the scattering by the light gases, the agreement between the simple theory and experiment is as close as could be expected for hydrogen, helium, and carbon. The probable explanation of the divergence between theory and experiment for the heavier atoms, like sulphur, has already been outlined. From the experiments of Geiger and Marsden (*loc. cit.*) on the large angle scattering of α particles by carbon, it is clear that the carbon atom behaves as if the nucleus carries a charge of about six units. Assuming this value of n for carbon, the results indicate that the hydrogen nucleus has a charge of *one* fundamental unit and the helium nucleus of *two* units. This value for helium is to be anticipated from

the observed fact that the α particle in its flight carries two unit positive charges.

The observations on the scattering of α particles by matter in general afford strong experimental evidence for the theory that the atom consists of a positively charged nucleus of minute dimensions surrounded by a compensating distribution of negative electrons. The charge on the nucleus for heavy atoms is approximately $\frac{1}{2}Ae$, where A is the atomic weight and e the electronic charge. The experiments in this paper on the scattering of simple gases indicate that the hydrogen atom has the simplest possible structure of a nucleus with one unit charge, and helium comes next with a nucleus of two unit charges. This simple structure for hydrogen and helium atoms has been assumed by Bohr* in a recent interesting paper on the constitution of atoms, and has been shown by him to yield very promising results.

We desire to express our thanks to Dr. Pring for his assistance in preparing and purifying the gases employed.

University of Manchester,
July 1913.

LVIII. *On the Transmission of X Rays through Metals.* By
H. B. KEENE, *Assistant Lecturer in Physics at the University of Birmingham* †.

MANY investigators have studied the transmission of X rays through metal sheets and the distribution of the "incident" and "emergent" radiation. The method of measurement adopted has been an electrical one, the photographic method having fallen into disuse. Its revival in the experiments of Messrs. Friedrich, Knipping, and Laue on the transmission of X rays through crystals and the remarkable results obtained, suggested that interesting results might follow with materials other than crystals if the ionization chamber was replaced by the photographic plate. It seemed probable that the ionization method might have overlooked certain effects which the photographic plate would record. A photographic investigation of the "incident" and "emergent" radiation from metal sheets led to some striking results which are described in the present paper.

* *Phil. Mag.* July 1913.

† Communicated by Prof. J. H. Poynting, F.R.S.

A medium-hard Cossor tube with an iridium anti-cathode and a sharp focus was used throughout the experiments. In all cases the photographic plate was enclosed in two thicknesses of stout black paper and the exposure given was two hours. A narrow cylindrical pencil of X rays (1.5 mm. diameter) was caused to fall at almost grazing incidence upon an excellent optical surface of speculum metal (see fig. 1). There was no evidence of regular reflexion, but a

Fig. 1.

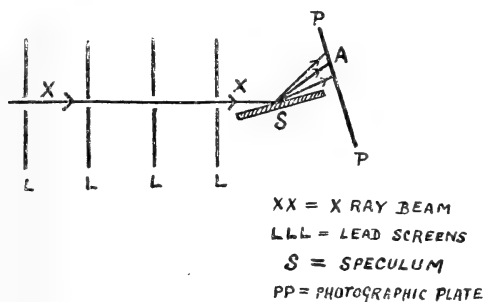

number of small irregular spots appeared on the plate scattered over the region at A. The spots of greatest intensity were those due to beams which had suffered the least deviation. If the metal surface was displaced sideways in its own plane, the direction of the primary beam remaining unaltered, it was found that the arrangement of the spots was no longer the same. Similar results were obtained with brass, while silvered glass and liquid mercury surfaces merely exhibited a general scattering. The effect is undoubtedly associated with the crystals in the metal. An examination of the brass surface under the microscope showed a multitude of well-formed crystals; none were visible on the speculum surface, possibly owing to their being covered by an amorphous layer produced in the polishing. The absence of spots with the silver surface on glass is to be attributed to the smallness of the crystals and to the extreme thinness of the layer deflecting only a minute fraction of the incident radiation; and in the case of the mercury to the absence of crystals.

A study of the "emergent" radiation from thin metal sheets gave results differing from those obtained by the ionization method.

The same narrow pencil of X rays was allowed to fall normally upon thin sheets of various metals. The photographic plate was placed in the path of the emergent beam, and in a plane parallel to that of the absorbing metal sheet (see fig. 2). The distance of the plate from the sheet was

Fig. 2.



MM. METAL SHEET

PP PHOTOGRAPHIC PLATE

25 mm. In all cases the metal sheets were so thin that the greater part of the radiation passed directly through them, and gave rise to an intense circular spot on the photographic plate. A portion of the remainder gave rise to drawn out spots or other markings surrounding the central beam.

As many of the negatives are unsuitable for reproduction owing to the fogging produced by the general scattering, the nature of the results are indicated in the accompanying diagrams.

Fig. 3 shows the result obtained with Russian sheet-iron (thickness = 0.4 mm.).

It will be seen that the streaks are radial, the majority of them lying on a circle representing a deflexion from the direction of the primary beam of about 10° . The interior of this halo is quite clear, while outside it fainter streaks are visible. An attempt to distort the pattern by placing the specimen between the poles of a powerful electromagnet during another exposure, gave a negative result.

Fig. 4 shows the distribution of the emergent radiation from cobalt (0.25 mm. thick). In this case the streaks are smaller and more closely packed.

Fig. 3.



Fig. 4.



Fig. 5 was obtained with platinum (0.1 mm. thick). A specimen of hard wood (*lignum vitae*) of thickness such as to have stopping power approximately equal to that of one millimetre of aluminium gave rise to no such markings.



The metal specimens mentioned above were taken from the laboratory stores, where they had remained unused for several years. Wishing to make experiments with nickel and aluminium, I found it necessary to roll out new specimens, as none of suitable thickness were available. These two samples yielded entirely different results.

Fig. 6 shows a perfectly symmetrical pattern obtained with the nickel (0.28 mm. thick) consisting of four diffuse patches which fade away towards their edges, gradually merging into the general fogging of the plate. No other streaks or patches were visible on the negative, and the patches forming the pattern showed no evidence of structure. The same description applies to the nature of the pattern obtained with the aluminium (1.0 mm. thick). The emergent radiation in this case gave rise to a symmetrical ten-pointed star

(see fig. 7). It was found that the orientation of the pattern was independent of that of the X-ray tube, while, on the other hand, a rotation of the metal sheet produced a corresponding rotation of the pattern on the plate.

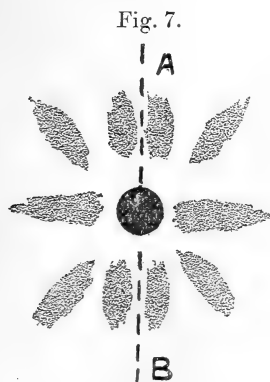

Precisely the same pattern was reproduced by using an entirely different part of the same metal sheet. This seemed remarkable at first sight, but further investigation showed that the axis of symmetry AB in both cases (figs. 6 & 7) was parallel to the direction in which the material had been rolled. This fact supplies a key to the explanation.

It must be borne in mind that the specimens yielding spots were all well aged, while those yielding symmetrical patterns were freshly rolled for the purpose. The former, through age or annealing,

were probably crystalline in structure, the microcrystals giving rise to small pencils of radiation from the planes of their space-lattices. That such an aggregate of small crystals should give rise to a group of streaks of this kind can be demonstrated by passing the beam through a collection of small crystals specially arranged for the purpose. This was done by sprinkling crystalline mercuric oxide on one side of a piece of cardboard which was covered with wet gum. The specimen was now placed normally in the path of the beam with the crystals towards the photographic plate. The resulting negative was of precisely the nature as shown in figs. 3, 4, & 5. This experiment indicates that the matrix in which the crystals of the metal sheets are embedded is of no account.

When a narrow pencil of light is allowed to pass through certain crystals and to fall upon a photographic plate, as in the above experiments, similar symmetrical patterns are obtained. Experiments carried out by H. S. Allen ('Nature,' xci. p. 268) have drawn attention to this phenomenon, and show that such patterns are only obtained with crystals which show a streaky appearance when examined by the naked eye. Dr. Tutton ('Nature,' xci. p. 268) attributes the patterns to "asterism," which, in the case of mica, "is due to fine enclosures arranged along the glide planes, and parallel to the cleavage plane. Calcite also shows asterism, certain crystals held in front of a candle-flame showing a radiating star of light. In this case, however, it is due to tubular cavities parallel to the glide planes (the rhombohedron known as $e\{110\}$)." According to H. S. Allen the striations in the crystal act just like a diffraction grating. It seems that the patterns shown in figs. 6 & 7 are to be explained in a similar way, being a case of asterism with X rays; the striations being produced in the material by the process of rolling.

If there is an alignment of the particles within a sheet of rolled metal, it should be possible to destroy the arrangement by heating the specimen, and so bringing it back to its original crystalline condition on cooling. In such a case one would expect a corresponding change in the pattern. This was tried with the aluminium specimen which gave the ten-pointed star. The metal was placed upon a flat slab and raised to its melting-point and then allowed to cool slowly. The resulting photograph with this annealed specimen was of the type shown in figs. 3, 4, and 5, all trace of the star having disappeared. A portion of the nickel sheet giving fig. 6 was treated in the same way with exactly the same result.

It is impossible to discuss here the nature of the structure giving rise to the symmetrical patterns until further experiments have been carried out. A variation in the nature of the anti-cathode may throw further light on the matter.

During the writing of this paper a brief announcement has appeared by E. Hupka (*Phys. Zeitschr.* xiv. p. 623) of similar figures obtained with platinum and gold sheets, while nothing was obtained with iron and aluminium. The anti-cathode of the X-ray tube used in E. Hupka's experiments was of platinum.

July 27, 1913.

LIX. *The Analysis of the β Rays from Radium B and Radium C.* By Professor E. RUTHERFORD, F.R.S., and H. ROBINSON, M.Sc., Lecturer in the University of Manchester*.

[Plate XII.]

THE problem of the distribution of the β rays from radioactive substances with regard to velocity has been the subject of much experiment and discussion. As the history of this subject has been previously treated in some detail by one of us †, it is only necessary here to draw attention to the more recent and salient facts. A great advance in our knowledge was made by the experiments of Hahn, Baeyer, and Meitner, who showed that the β rays from the majority of radioactive substances consisted of a number of separate groups, each of well-defined velocity. If a narrow pencil of β rays, falling normally on a photographic plate, were deflected by a magnetic field, the radiation was split up into its component groups and a veritable spectrum was observed. This showed that the radiation, while heterogeneous in type, was made up of a number of distinct groups of β rays, each of which comprised β particles, which were expelled from the radioactive substance with a definite and characteristic velocity. A further advance was made by Danysz ‡ who examined, also by a photographic method, the deflexion in a magnetic field of the β rays emitted from an intense source of radium emanation enclosed in a thin-walled glass tube. The β rays in this case do not come from the emanation but from its

* Communicated by the Authors.

† Rutherford, 'Radioactive Substances and their Radiations,' pp. 209-212 (1913).

‡ Danysz, *Compt. Rend.* 153, pp. 339, 1066 (1911); *Le Radium*, ix. p. 1 (1912).

products radium B and radium C in equilibrium with it. He showed that the β rays from radium B+C were exceedingly complex, and was able to show the presence of nearly 30 homogeneous groups of β rays from these two products together. In a later paper* he has used a somewhat different and more certain method for determining the velocity of each of the groups, and has given a corrected list of 25 lines.

There is a very marked distinction between the emission of α and β particles from a radioactive atom. As is well known, the atom of each α -ray product emits during its transformation only one α particle, which is expelled with a definite velocity characteristic of the substance. Since it is also known from the experiments of Makower, Moseley, Duane and Danysz that each atom of radium B and C in disintegrating does not emit more than one or two β particles, it is clear that each atom cannot contribute one β particle to each group. This is also borne out by the fact that the photographic intensities of neighbouring groups of β rays differ markedly from one another. In order to explain these anomalies, Rutherford † suggested that a single β particle of definite velocity was set free by the transformation of each atom. This β particle in escaping from the atom set the electronic distribution in vibration, and in consequence lost energy in multiples of certain units depending on the system set in vibration. The decrease of energy of the issuing β particle due to these causes was variable in different atoms, depending upon the chance of passing through or close to the systems to be set in vibration. On this view, the large number of homogeneous groups of β particles emitted from a single radioactive substance was to be ascribed not to a single atom but to a statistical effect of a large number of atoms. The energy lost by the escaping β particle was converted into energy of the γ -ray form, and different types of γ rays would be emitted depending on the systems set in vibration. Taking this view, the appearance of homogeneous groups of β rays was intimately connected with the excitation of different types of γ rays in the atom. This hypothesis is strongly supported by the observation that all those radioactive substances which emit well-defined groups of β rays also give rise to marked γ radiation. In order to throw light on this question, Rutherford and Richardson ‡ have analysed the γ radiation

* Danysz, *Le Radium*, x. p. 4 (1913).

† Rutherford, *Phil. Mag.* Oct. and Dec. 1912.

‡ Rutherford and Richardson, *Phil. Mag.* May and August 1913.

from several radioactive substances. They have shown that radium B emits three distinct types of γ rays, radium C one penetrating type, radium D two distinct types, while radium E, which gives a continuous spectrum of β rays, emits only a minute amount of γ radiation.

Before any theory of the origin of β and γ rays can be adequately tested, it is necessary to determine with the greatest possible precision the velocity of each of the component groups of β rays. We have consequently made a large number of experiments to determine the groups of β rays emitted by radium B and by radium C separately. A strong source of radium emanation enclosed in a thin-walled α -ray tube affords a most convenient source for determining the velocity of the swifter groups of β rays from radium B and C together. An intense source of radium C deposited on a nickel wire has allowed us to distinguish between the groups to be ascribed to radium B and radium C separately. Since it is important to determine the velocity of groups of β rays which are photographically very weak, it was necessary to devise a method of bringing out the presence of groups of β rays, the total energy of which might be only a small fraction of that distributed in the more intense groups. For this purpose, we have used a special method which appears to be very similar in principle to that employed by Danysz in his later investigation (*loc. cit.*). The great theoretical and practical advantages of this arrangement lie in the fact that the β rays of a definite velocity comprised in a comparatively wide cone of rays can be concentrated in a line of very narrow width on the photographic plate. In this way a group of β rays of very small energy can be detected even when there is a marked darkening of the photographic plate due to the γ rays and the scattered β rays which must always be present.

The method employed is shown in fig. 1. The source S is attached about 1 cm. from the end of a lead block L ($9 \times 4 \times 3.2$ cm.). A comparatively wide slit V is arranged vertically above the source, and the latter was usually 1-2 cm. below the slit. The photographic plate PP is laid on the top of the lead block. It rested against one end of a plate about 1.5 cm. from the edge of the slit. The photographic plate was kept in position by means of a small screw attached to the lead block. When the source and photographic plate were placed in position, the whole apparatus was lowered into a brass vessel B B, which was closed by an upper plate by means of screws. The vessel was then exhausted to a low vacuum in a few minutes. The

brass vessel was placed between the parallel pole-pieces (17×10 cm.) of a large electromagnet. The pole-pieces were adjusted so that the magnetic field was very nearly uniform over the greater part of the space between them. The

Fig. 1.

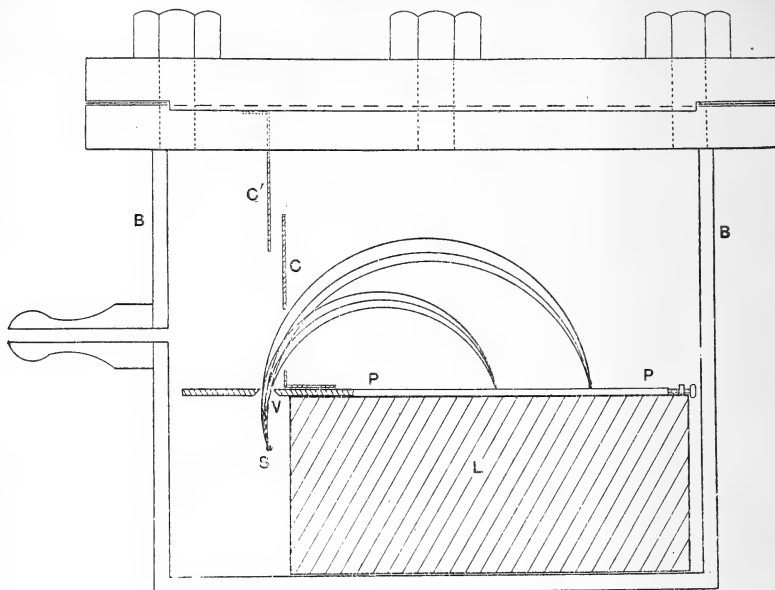

magnetic field was parallel to the source and slit. In the uniform magnetic field the β particles of a definite velocity describe circles of the same radius. It can be shown theoretically that even with a comparatively wide slit the circles intersect the photographic plate along a curved line of comparatively narrow width. This result, however, is most clearly shown by drawing circular paths of β rays of definite velocity. It is seen from fig. 1 that if the pencil of rays comprised β rays of only one velocity, the whole pencil of rays would be concentrated along a narrow line on the photographic plate, and consequently the photographic impression for a given exposure would be far more confined and intense than if the photographic plate were placed vertically above the slit where the cone of rays is comparatively wide.

It is clear from the figure that this concentration holds for β rays of different speeds. Special precautions were taken to reduce the effect of the scattered β radiations which must necessarily be present. Apart from the question

whether a continuous spectrum of β rays is superimposed on the line spectrum, β rays are excited in all parts of the vessel on which the γ rays fall; in addition, the rays falling on the photographic plate are partially scattered in all directions. These disturbing effects were reduced to a minimum by lining the vessel with thick cardboard, and placing cardboard screens CC' in the positions shown in the figure. It is also clear from the figure that the direct effect of the γ rays on the photographic plate was greatly reduced by their passage through the lead block.

The essential conditions for bringing out lines of feeble intensity depend mainly on the conditions: (1) narrow source, (2) a uniform magnetic field over the whole path of the β particles, (3) a comparatively wide slit; the width of slit employed in most of the experiments varied from 1–3 mm. The lines were comparatively sharp even with the widest slits used; and photographs could be obtained with exposures so short that the effect of the scattered radiations was relatively much reduced.

Under the experimental conditions, the *outside* edges of the lines were very sharply defined, but there was a distinct shading off towards the slit. This was especially marked in the strong groups of β rays from radium B, using the α -ray tube as a source.

The measurements were always made on the sharp outside edge of the line, and the radius ρ of the circular path could be readily determined for the rays forming this part of the trace. To a first approximation, it is given by $\rho = \sqrt{D^2 + a^2}$ where $2D$ is the distance of the outside of the line from the centre of the slit, and $2a$ the distance of the source from the slit. The position of the source relative to the slit was accurately measured in each experiment with the aid of a travelling microscope provided with a horizontal and vertical movement.

The positions of the strong lines on the plates were determined with the aid of a travelling microscope. The weak lines, however, were too faint to be seen in the microscope. It was consequently necessary to mark their positions on the plate with a fine pen. Each plate was marked several times, and the measurements of a given line in most cases were found to be in close agreement. It is obvious, however, that the position of weak lines could not be determined by this method with the same accuracy as for the stronger lines.

In order to examine the whole extent of the β -ray spectrum, photographs were taken in ten different magnetic fields, increasing with approximately constant ratio from

about 200 gauss to 6300 gauss. In all, more than fifty separate photographs were taken.

The apparatus described above could be conveniently used up to fields of 3500 gauss. For the higher fields a similar apparatus to that shown in fig. 1 was used, but with an internal breadth of only 1.9 cm. instead of 3.2 cm. Another similar electromagnet was used and, with the narrower gap, constant fields of over 7000 gauss could be obtained without excessive heating of the magnet.

Each group given in the Tables I. and II. was observed in widely differing positions on three different plates. It was possible from this circumstance to check the accuracy of the measurements of the magnetic fields, and also the uniformity of the magnetic field over the whole region between the poles. It was usually found that when a line appeared on the plate at a distance of more than 7 cm. from the slit, the measurement gave slightly too high values of the radius of curvature, on account of the β particle entering the outer and non-uniform regions of the magnetic field. All the final measurements were confined to lines appearing on the photographic plate within 6 cm. from the slit. The uniformity of the magnetic field in both vertical and horizontal directions was carefully tested by means of a small search coil, and the positions of the poles so adjusted as to give equality of field over a considerable area. The field itself was measured by standard coils and a ballistic galvanometer in the usual way. Measurements of the intensity of the magnetic field for a given current gave results consistent to 1 part in 300, provided the iron was brought into a cyclic state by a number of reversals of the exciting current. This precaution was more especially necessary in the case of the weaker fields.

Sources of β Rays employed.

- (1) Thin-walled emanation tube.
- (2) Wires coated with radium B and C.
- (3) Wires coated with radium C alone.

As already mentioned, the high velocity groups of rays were first photographed by using an α -ray tube. The thickness of the glass wall of the tube corresponded in stopping power for the α rays to 1.2 cm. of air. There was a small correction for the decrease of velocity of the β particle in traversing the glass. This was made by observing the shift of the lines when a thin mica plate of known thickness was placed immediately over the source. The corrections were

found to be in good agreement with those previously tabulated by Danysz*. The α -ray tube could be used for determination of β rays from radium B and C together of velocities not less than $\cdot 67$ of that of light. For the lower velocities, a fine wire was made intensely active by exposure in a capillary tube to about 150 millicuries of purified emanation. Since here no correction for absorption of the β rays is required, the measurements afforded a useful check on the corrections made in some of the lower velocity lines obtained with the α -ray tube.

From the experiments of Hahn, Baeyer, and Meitner, it was known that of nine strong groups of β rays, five were due to radium B, and the remaining four to radium C. Since it was of great importance to distinguish definitely between the lines to be ascribed to radium B and radium C, a large number of experiments were made using pure radium C as a source. This was obtained by von Lerch's method, by immersing a nickel wire about 1.2 cm. long and 0.3 mm. diameter in a solution of the active deposit of radium in hot hydrochloric acid. By the use of large quantities of emanation in narrow tubes, it was found possible to make the wire so active as to equal in γ ray effect 50 milligrams of radium in equilibrium. To avoid all possibility of admixture of radium B, the nickel wire was not introduced into the solution until 20 minutes after the withdrawal of the emanation. Not a single trace of even the strongest lines of radium B was detected in any of these photographs. On the other hand, the wire was sufficiently active to bring out all but the faintest of the radium C lines observed with the relatively much stronger source afforded by the α -ray tube. The advantage of using a wide slit was especially marked in the experiment with radium C. It was found that the lines of the spectrum of radium C extended even into the regions occupied by the lowest velocity lines of radium B, although in the photographs taken with the sources containing both β -ray products, they were to a large extent masked by the strong photographic effect of the radium B rays. As a result of our experiments, we have found that radium C emits a very large number of distinct groups of β rays: in all we have observed more than 50 on the radium C plates alone. In addition, there are a number of other lines which can be seen only with great difficulty with specially arranged illumination. Only those lines are included in our list which have been definitely located on several photographs with at least two different fields. There are very great variations in

* Danysz, *Compt. Rend.* cliv. p. 1502 (1912).

the intensities of the different groups. On account of the great penetrating power of the high velocity β particles, the photographic effect for equal numbers of particles is relatively much weaker than that for the slower rays. In consequence of this, three or four times the length of exposure was required to bring out clearly the groups of high velocity β rays. In the absence of definite knowledge of the relative photographic effects of β rays of different velocities, it is desirable to classify the intensity of a given group by the strength with which it stands out above the general photographic fog due to scattered radiation &c. The following symbols, in order of decreasing intensity, have been used:—

v.s., very strong; s., strong; m.s., moderately strong; m., mean intensity; m.f., medium faint; f., faint; v.f., very faint.

In addition, it is convenient for reference to mark the strong lines by a letter.

It is evident from the nature of the problem and the large number of lines examined that this classification must be somewhat arbitrary, but it suffices for a general indication of the variation of intensity among the groups.

In the following table column I. gives the distinctive number of the line, II. the intensity; column III. the value of $H\rho$ where H is the magnetic field in gauss and ρ the radius of curvature in cm. Column IV. gives the value of β , the

TABLE I.
Groups of rays from Radium B.

I.	II.	III.	IV.	V.
No.	Int ^y .	$H\rho$.	β .	Energy $\div 10^{15}e$.
1	f.	2450	·823	3·852
2	m.s.	2295	·805	3·480
3A	s.	2235	·797	3·332
4	v.f.	2140	·787	3·160
5	m.s.	1990	·762	2·758
6B	v.s.	1925	·751	2·610
7	m.	1815	·731	2·366
8	m.s.	1752	·719	2·228
9C	v.s.	1660	·700	2·039
10	m.s.	1470	·656	1·650
11 D	v.s.	1392	·635	1·519
		Groups.		
12	m.	950-914	—	—
13	m.	861-836	—	—
14	m.s.	798	·426	·539
15 E	s.	770	·414	·503
16 F	v.s.	663	·365	·376

TABLE II.
Groups of rays from Radium C.

I.	II.	III.	IV.	V.	VI.	VII.
No.	Int ^y .	H ρ .	β .	Observed Energy $\div 10^{13}e$.	Multiple of E ₁ .	Calculated Energy $\div 10^{13}e$.
1	f.	9965	·9858	25·25	59	25·30
2	f.	9605	·9850	24·19	57	24·45
3	f.	9375	·9840	23·51	55	23·59
4	f.	9115	·9830	22·73	53	22·73
5	f.	8835	·9822	21·91	51	21·88
6 A	m.f.	8530	·9808	21·02	49	20·99
7	f.	8260	·9797	20·22	47	20·13
8	f.	8050	·9786	19·61	46	19·70
9	f.	7820	·9773	18·93	44	18·83
10	f.	7650	·9764	18·43	43	18·40
11	f.	7490	·9754	17·96	42	17·97
12 B	m.f.	7335	·9744	17·51	41	17·56
13	f.	7200	·9734	17·11	40	17·14
14 C	m.	7060	·9724	16·71	39	16·71
15	f.	6910	·9712	16·28	38	16·28
16	f.	6760	·9700	15·83	37	15·85
17	f.	6616	·9687	15·42	36	15·42
18	f.	6483	·9676	15·03	35	14·99
19	f.	6310	·9658	14·52	34	14·56
20 D	m.	6160	·9643	14·09	33	14·13
21	f.	6000	·9624	13·63	32	13·71
22 E	m.s.	5880	·9610	13·28	31	13·28
23	f.	5720	·959	12·82	30	12·85
24	f.	5520	·956	12·24	29	12·42
25	v.f.	5386	·954	11·86	28	11·99
26 F	m.	5255	·952	11·49	27	11·57
27	f.	5110	·949	11·07	26	11·14
28	f.	4990	·947	10·73	25	10·71
29 G	m.s.	4840	·946	10·31	24	10·28
30	m.f.	4880	·933	8·91		
31	m.f.	4180	·927	8·45		
32	m.f.	3900	·917	7·68		
33	m.f.	3555	·903	6·74		
34	m.f.	3320	·891	6·11		
35 H	m.s.	3260	·887	5·94		
36	m.f.	3160	·881	5·67		
37	m.f.	3070	·876	5·44		
38 K	s.	2960	·868	5·16		
39	f.	2870	·861	4·91		
40	f.	2820	·857	4·79		
41	m.f.	2700	·847	4·48		
42	f.	2530	·831	4·05		
43	f.	2235	·797	3·33		
44 L	m.	2080	·776	2·96		
45 M	m.	1918	·750	2·59		
46 N	m.	1550	·675	1·81		
47	f.	1440	·648	1·59		
48	f.	1380	·632	1·49		

velocity of the particle in terms of the velocity of light: this is calculated from the value of $H\rho$ with the aid of the Lorentz-Einstein formula

$$m/m_0 = (1 - \beta^2)^{-\frac{1}{2}} ;$$

e/m_0 is taken as 1.772×10^7 c.m. units.

Column V. gives the total energy of the electron, calculated from the Lorentz-Einstein formula

$$E = \frac{m_0}{e} c^2 \left(\frac{1}{\sqrt{1 - \beta^2}} - 1 \right) e,$$

where c is the velocity of light.

The energy is expressed in terms of e in order to avoid any assumption with regard to the accuracy of any particular value of the electronic charge.

Radium B Groups.

A diagrammatic representation of the lines from radium B is shown in fig. 2 (Pl. XII.). Using an emanation tube as a source, no lines above $H\rho = 2450$ were observed which could be definitely ascribed to radium B. It would no doubt be difficult to detect very faint lines in higher fields on account of the masking action of the strong photographic effect of the rays from the radium C groups. Both H. W. Schmidt* and Fajans and Makower† have observed that radium B emits some fairly penetrating β radiation. If this radiation be due to some groups of comparatively high velocity, it is to be expected that their photographic intensity would be small, and consequently difficult to detect in experiments with a source containing radium B and C together. In addition to the lines recorded, a number of faint groups were observed between $H\rho = 1392$ and $H\rho = 950$. These apparently consisted of two or more lines close together, but it was difficult to measure their position with accuracy.

The measurements of most of the strong lines are in fair agreement with those given by Danysz (*loc. cit.*) in the photographs obtained with radium B + C together.

It may be remarked that in a few cases lines due to radium B and radium C are exactly, or very nearly, coincident. This occurs in the case of the complex groups $H\rho$ 836-861, 914-950, in the low velocity part of the spectrum.

* A. W. Schmidt, *Ann. d. Phys.* xxi. p. 609 (1906).

† Fajans and Makower, *Phil. Mag.* xxiii. p. 292 (1912).

These groups are strongly marked in the photographs obtained with wires coated with radium B+C, and fainter groups in very nearly the same positions were obtained on the radium C plates. To test this point further, photographs were taken with very short exposures of wires which had themselves only been exposed to the emanation for a short time, and thus had a much larger proportion of radium B to radium C than usual. The groups appeared of the same intensity, relative to the main radium B lines, as in the other radium B+C photographs, showing that they were undoubtedly due to radium B.

Radium C Groups.

A diagrammatic representation of some of the stronger lines from radium C is shown in fig. 2 (Pl. XII.). It is seen that radium C gives a spectrum in which the difference of intensity between the lines is relatively not so marked as in the case of radium B. The group of highest velocity observed in radium C, which showed up clearly on the photographs, gave the value of $H\rho=8530$. Five other faint lines of higher velocity are recorded, and a number of others of still higher velocity could be faintly seen. Although we made a number of experiments in strong magnetic fields, no evidence of any strong line of higher velocity was observed, although lines up to $H\rho=20,000$ would have been observed on the photographic plates.

In most of the experiments with β rays, an ordinary process plate was employed. We found it, however, advantageous for the higher fields to employ X-ray plates. These were photographically much more sensitive, and the fainter lines in the strong fields were more clearly seen. We have included a fairly complete list of the lines from $H\rho=9965$ to $H\rho=4840$. For still lower values of $H\rho$, the plates obtained with radium C as a source were crowded with fine lines, and only a few of the stronger are included in the table and in fig. 2 (Pl. XII.). For example, only five lines have been included between $H\rho=4840$ and $H\rho=3260$, although more than twenty were measured up. In a similar way, only a few of the more marked lines are recorded in the lower fields.

A complete analysis of the weaker lines would take a large amount of work, but it was not felt desirable at this stage to include them. It should be mentioned that the radium C lines extend right down to the low velocity regions, for which radium B shows several strong lines. It is of interest to note that radium C showed complex groups in about the same region as for radium B. We have already mentioned

that in some cases it was very difficult to decide whether these complex groups belonged to radium B or radium C. Danysz, in his last paper, gave values for eight lines between $H\rho=2947$ and $H\rho=6073$ which are due to radium C. For most of these lines there is a fair agreement with the values found by him.

It should be remarked that all of the groups of β rays from radium C appear to be very closely homogeneous. The lines on the photographs were in all cases sharply marked, and there was no evidence of widening of the band to indicate that the group contained electrons of velocities varying between small limits. The strong lines due to radium B are always diffuse on the inner side when obtained with an α -ray tube. This no doubt is partly due to an alteration of the velocities in escaping through the walls of the glass tube. At the same time there is some evidence from the experiments with active wires that the velocities in the strong groups are variable over comparatively narrow limits.

General Considerations.

On the theory of the origin of β and γ rays proposed by one of the authors (*loc. cit.*), it is to be expected that the differences between the energies of the β particles in different groups should be expressed by an integral number of one or more constants. These constants occurring represent the energy abstracted from the β particle in passing through certain regions of the atom, which are converted into energy of the γ -ray form. It is not proposed at this stage to enter into a discussion of the groups from radium B, as the experiments of Rutherford and Richardson (*loc. cit.*) have shown that the γ radiation from this substance is very complex, consisting of three distinct types widely differing from one another in penetrating power. Before the theory can be adequately applied in this case, the velocity of each group must be known with greater precision than it is at present. On the other hand, the same authors have observed that the γ radiation from radium C consists essentially of one penetrating type, and it is consequently to be expected that if any simple relation exists between the lines, it should be most obvious amongst the higher velocity electrons ejected from radium C. There seems to be fairly definite evidence of a relation of this character, at any rate between 29 lines given in the table for radium C. Taking the value of this difference as $E_1=0.4284 \cdot 10^{13}e$, it is seen that all the lines observed from Nos. 1 to 29 fall closely into position. For the higher velocity groups, the average difference is twice this value,

or $2E_1$, but all the lines between Nos. 9 and 29 are approximately expressed by the simple difference E_1 , and *no lines are missing*. As the value of the energies of the fainter lines could not be determined with the same precision as the stronger lines, the agreement is probably as close as one could expect considering the difficulty of the measurements. It should, however, be pointed out that a line of medium intensity was observed before nearly all of the strong lines on the high velocity side. As far as measurements could be made, this "outrider" appeared to be somewhat closer to the strong line than would be expressed by a difference of the energy E_1 . It is, however, difficult to decide this point definitely on account of the wide difference in intensity of the two lines.

It is also of interest to note that the energy of each of the lines is nearly an *integral* multiple of the common difference. This is clearly seen in Table III., where the value of the whole number is given in column VI. and the corresponding calculated value of the energy in column VII. If this relation should hold, it would indicate that the groups of β rays observed are not directly due to the original β particle which causes the disturbance, but rather to the emission of energy in the β -ray form consequent on the vibrations of certain definite systems of electrons within the atom.

Below line No. 29, where only a few of the stronger lines are given, it was found that this simple relation no longer held, for the differences between some of the lines were much smaller than E_1 . It is to be anticipated that the theoretical analysis of the slow velocity electrons for radium C would be very complex and present great difficulties. This follows from the fact that the electrons, as their velocities decrease, become more effective in exciting γ rays in the outer regions of the atoms.

The value of E_1 found by experiment is only about one-third of the value calculated from Widdington's results on certain assumptions*. It is intended to continue experiments, and to analyse in detail the groups of β rays from other radioactive substances. It is hoped that when more data are available it will be possible to test with considerable certainty the adequacy of any theory in explanation of the origin of β and γ rays.

We are indebted to Mr. J. M. Nuttall for his kind assistance in some of the measurements.

University of Manchester,
July 1913.

* See Rutherford, "Origin of β and γ rays," *Phil. Mag.* Oct. and Dec. 1912.

LX. *Low Potential Discharges in High Vacua.*

GENTLEMEN,—

IN a paper published by Strutt in the 'Proceedings' of the Royal Society (Hon. R. J. Strutt, Proc. Roy. Soc. vol. lxxxix. p. 68, 1913) an interesting series of experiments is described on the phenomena of low-potential discharges in high vacua. The experiments show definitely that one simple method of treating some of the observed effects, is to consider the case of a discharge between two coaxial cylinders when a magnetic force is acting in a direction parallel to the axis of the cylinders.

When the gas is at low pressure and the magnetic field is zero, a potential difference of the order of 200,000 volts is required to produce a discharge, but when the magnetic field is created the discharge passes when a potential difference of 300 or 400 volts is established between the cylinders. In the latter case the electrons travel spiral paths.

Strutt also gives a theory of these phenomena in which he adopts the view that in an ordinary vacuum-tube, without magnetic force, electrons starting from the cathode are not able to ionize the gas until they have travelled a certain distance represented by the Crookes dark space.

This hypothesis is not in accordance with the results of simple experiments on the currents obtained between parallel plates.

The normal fall of potential across the Crookes dark space in air is about 340 volts, and measurements of the effects obtained by collisions show that an electron ionizes a molecule when it collides with a velocity acquired under a potential fall of 25 volts. The electric force is very high near the cathode in a discharge-tube, so that if an electron started with zero velocity, it would acquire sufficient velocity to ionize a molecule before it had traversed one twentieth part of the dark space. There can thus be very little doubt that these electrons ionize many of the molecules in the dark space.

In order to explain the effect of the magnetic force the electron, after starting from the cathode, is supposed to acquire the property of ionizing a molecule after it has travelled some distance in its spiral path, although it would not have acquired this property after travelling a short straight path under the action of the same potential fall when the magnetic force is zero. A distinction is thus drawn between the properties of electrons that have traversed long

paths, and those that have traversed short paths with the same mean velocity.

There does not seem to be any adequate reason why these hypotheses should be adopted, and the experiments may be explained more simply by considering the processes which contribute to the formation of ions in the discharges that occur when a potential difference of the order of 400 volts is established between the electrodes.

In general, the formation of ions in discharges is due to different effects which vary in importance according to the pressure of the gas. For simplicity, the discharges in air between parallel plates one centimetre apart may be considered. At high pressures exceeding .5 millimetre the principal effects may be attributed to the action of the positive and negative ions on the molecules of the gas.

If α represents the number of ions generated by a negative ion, per centimetre of its path, under a given force, β the corresponding number for positive ions, at high pressures, α and β increase when the force is increased or the pressure diminished. Hence as the pressure diminishes the potential required to produce a discharge also diminishes.

At a certain pressure, depending on the force, α attains a maximum value. If the force is 340 volts per centimetre, α has a maximum value when the pressure is .95 millimetre, and the velocity with which the electron collides with molecules is sufficiently great to produce ionization in a large number of cases. A further reduction in the pressure increases the velocity of the electron and a larger proportion of the molecules with which it collides are ionized, but the total number of collisions is reduced, so that α diminishes. At pressures less than .1 millimetre the value of α is practically proportional to the pressure and independent of the force, provided the force exceeds 300 volts per centimetre. Thus α becomes very small at low pressures owing to the fact that the number of collisions the electron makes with molecules in traversing the distance between the electrodes is very small.

The effect of the positive ions does not diminish when the pressure is less than .95 millimetre. The value of β increases but not so rapidly as to supply the deficiency caused by the reduction in α , so that at .01 millimetre the potential required to produce the discharge becomes very large and ions are generated by other processes, in addition to the effects produced by collisions with molecules of the gas.

In Strutt's experiments in high vacua the electrons produce very little effect in traversing the distance $R-r$ between the

cylinders, when the magnetic force is zero, *since they meet with so few molecules.*

When the magnetic field is applied the electrons travel in spirals, the distance S which they traverse in passing through the gas is very much greater than $R-r$, and the number of molecules that an electron meets in travelling from one electrode to another is increased in the proportion of $S/(R-r)$. If $S/(R-r) = 20$, which is a possible value, the effect of the magnetic field is the same as if the pressure were increased from $\cdot 01$ millimetre to $\cdot 2$ millimetre, as far as the ions generated by the electrons are concerned.

The potential difference required to produce the discharge is thus reduced to the value corresponding to a higher pressure when the magnetic field is applied.

Yours truly,

JOHN S. TOWNSEND.

LXI. *On some new Multiple Relations of the Atomic Weights of Elementary Substances; and on the Classification and Transformations of Neon and Helium.* By HENRY WILDE, D.Sc., D.C.L., F.R.S.*

IN several of my papers which have been published by the Society during past years on the multiple proportions of the atomic weights, special attention was directed to the series $H7n$ on account of the magnitude and importance of its primary members in the economy of nature. Silicon (symbol Si), in combination with oxygen, constitutes more than half the weight of the earth's crust, and is the principal constituent of glass for all the purposes of civilized life. Nitrogen (N) forms nearly four-fifths of atmospheric air, and is an essential element in organic nature. Iron (Fe), from its magnetic and other physical qualities, is a necessity in modern civilization. Gold (Au) is of æsthetic importance from the brilliancy and permanence of its colour, while the comparative rarity of its occurrence in nature admirably adapts it as a standard of commercial value.

It is not a little remarkable that while the physical properties of most of the principal elements are well determined

* Communicated by the Author. From 'Memoirs and Proceedings of the Manchester Literary and Philosophical Society,' vol. lvii. Part iii. (1912-13).

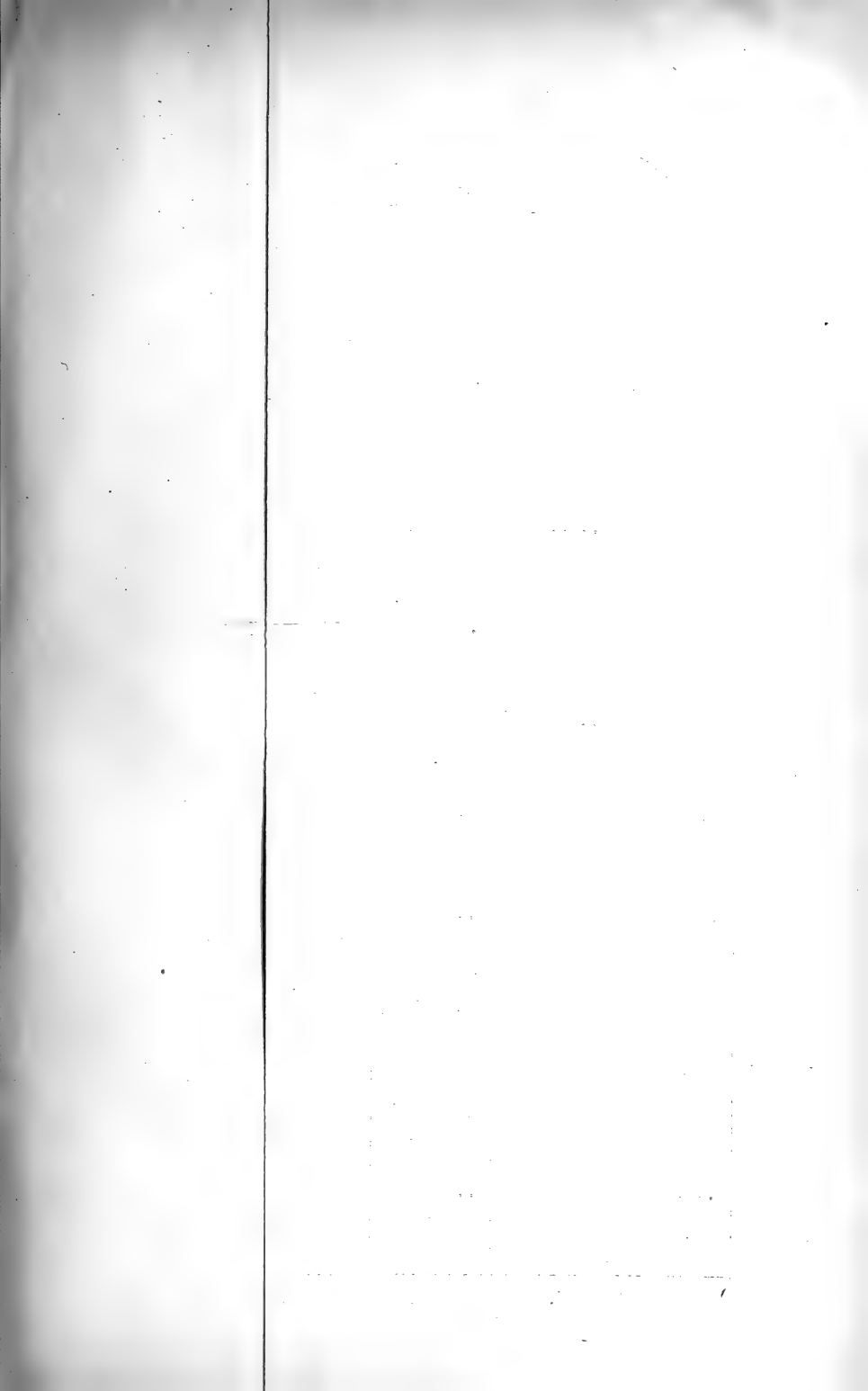

[To face p. 733.

—1903—1906—1913.

<hr/>	
H7 _n	
Ne = 7	
<hr/>	
N = 14	
Ar = 21	
Kr = 42	
Xe = 63	
Si = 35	
2·49	
Fe = 56	56—8·14
Mn = 56	55—8·00
Ni = 56	58—8·66
Co = 56	58—8·96
Pd = 105	105·6—12·0
Rh = 105	104·4—11·2
Ru = 105	104·4—11·4
Da = 105
Au = 196	196—19·34
Pt = 196	197—21·50
Ir = 196	198—22·42
Os = 196	198—22·48
<hr/>	

ctro-deposited.

. P. Cooke, F. W. Clarke,

within small fractional quantities, the atomic weight and correlated specific heat of silicon are still open to revision, notwithstanding the large amount of attention which has been given by chemists to determine these constants of nature.

In order that the connexion between the results of the present paper with my former researches may be seen without the trouble of references, I will recapitulate several of the points previously discussed, together with the explanatory tables of atomic weights.

Since the investigation of the properties of silicon by Berzelius, who regarded silicic acid as a trioxide, much discussion has arisen as to whether the atomic weight of silicon should be 21, 28, or 35, and the formula for its oxide Si_2O_3 , SiO_2 , or Si_2O_5 .

Through the classical researches of Regnault the specific heat of silicon was found to be 0.176*. The determination was made with specimens of the metalloid of considerable size and in a state of compactness and purity to receive a polish which formed a perfect mirror. The above number multiplied by 28, the highest atomic weight assigned to Si, gives the product 4.93, while the law of Dulong and Petit requires the value 6.25.

In discussing the cause of the anomalous atomic heat of silicon, Regnault pointed out that in order that it might enter into the law of the specific heat of other elements, it would be necessary to write the formula of silicic acid Si_2O_5 ; it would then resemble that of nitric, phosphoric, and arsenic acid. The atomic weight of silicon would then be 35, and the product of this number and the specific heat would be nearly 6.25, which agrees with the analogous products that other simple bodies give. By assigning to silicon a higher atomic weight and a polybasic character like that of phosphorus or nitrogen, Regnault remarked that it is easy to explain the existence of the great number of silicates which nature presents in well-defined and beautiful crystals, and to understand the existence of the natural hydro-silicates.

It will be seen from my general Table that the atomic weights of nitrogen, silicon, and iron, besides being whole numbers, are exact multiples of H 7; and in all the formulæ proposed for the constitution of silica the atomic weight of silicon is a multiple of 7. These formulæ are given below,

* *Annales de Chimie et de Physique*, liii. pp. 24-31 (1861)

TABLE I.

Elementary Substances, with their Atomic Weights in Multiple Proportions, 1878—1894—1902—1903—1906—1913.

	+H _n -		+H _{2n} -		H _{3n}	H _{4n}	H _{5n}	H _{6n}	H _{7n}	
1	H = 1		He = 2						Ne = 7	
2	Li = 7 ... 7* 0.59†		Be = 8 ... 9.2 1.64		C = 12 ... 12 1.71§	- = 16	B = 10 ... 11 2.63	- = 18	N = 14 Ar = 21 Kr = 42 Xe = 63	
3	Na = 23 ... 23 0.98	F = 19 ... 19	Mg = 24 ... 24 1.74	O = 16 ... 16	Al = 27 ... 27 2.56	- = 32	P = 30 ... 31 1.82	- = 36	Si = 35 2.49	
4	K = 39 ... 39 0.86	Cl = 35 ... 35.5 1.3	Ca = 40 ... 40 1.8	S = 32 ... 32 2.05	Sc = 42 ... 44 3.4	Ti = 48 ... 48 4.1‡	V = 50 ... 51.2 5.5	Cr = 54 ... 52.4 7.3	Fe = 56 Mn = 56 Ni = 56 Co = 56	56—8.14 55—8.00 58—8.66 58—8.96
5	Cu = 62 ... 63.3 8.9		Zn = 64 ... 65 7.2		Ce = 69 92 : 141 6.5	Ge = 72 ... 72.7 5.47	As = 75 ... 75 5.63			
6	Rb = 85 ... 85 1.52	Br = 81 ... 80 3.0	Sr = 88 ... 87.5 2.54	Se = 80 ... 79.4 4.8	Ga = 96 ... 70 5.95	Zr = 92 ... 90 4.15? 5.4‡	Nb = 95 ... 94 6.67	Mo = 96 ... 96 8.6		
7	Ag = 108 ... 108 10.6		Cd = 112 ... 112 8.69		Y = 123 61.7 : 89.5 8.1‡	Sn = 116 ... 116 7.29	Sb = 120 ... 120 6.72		Pd = 105 Rh = 105 Ru = 105 Da = 105	105.6—12.0 104.4—11.2 104.4—11.4
8	Cs = 131 ... 132 1.88	I = 127 ... 127 4.95	Ba = 136 ... 137 3.75	Te = 128 ... 128 6.3	In = 150 75.6 : 113.4 7.42	La = 140 ... 139 6.7	X = 140 8.15‡	X = 144 10.0‡		
9	X = 154 12.2‡		X = 160 10.13‡		Er = 177 ... 170.6 9.4‡	X = 164 9.11‡	X = 165 8.30‡			
10	X = 177 2.2‡		Ra = 184 4.8‡		Tl = 204 ... 204 11.85	D = 188 ... 95 8.0‡	Ta = 185 ... 182 10.78? 9.8‡	W = 186 ... 184 18.26		
11	Hg = 200 ... 200 13.6		Pb = 208 ... 207 11.44		Th = 231 ... 231.4 11.23	U = 240 ... 240 18.4	Bi = 210 ... 210 9.83		Au = 196 Pt = 196 Ir = 196 Os = 196	196—19.34 197—21.50 198—22.42 198—22.48

* Accepted Atomic Weights.

† Specific Gravities.

‡ Estimated.

§ Anthracite.

|| Electro-deposited.

** The accepted atomic weights are taken from the standard works and tables of Wurtz, Roscoe and Schorlemmer, J. P. Cooke, F. W. Clarke, and Watts's 'Dict. Chem.' Suppl. p. 247—Atomicity.

with the old and new atomic weights, the proportion of silicon to oxygen being in the ratio of 7 : 8 in all the formulæ.

1. Si O = Si 7 : O 8 :: 7 : 8
2. Si O₂ = Si 14 : O 16 :: 7 : 8
3. Si O₂ = Si 28 : O 32 :: 7 : 8
4. Si O₃ = Si 21 : O 24 :: 7 : 8
5. Si O₃ = Si 42 : O 48 :: 7 : 8
6. Si₂O₅ = Si 35 : O 40 :: 7 : 8
7. Si₂O₅ = Si 70 : O 80 :: 7 : 8

I have shown that the ordinal number of the typical molecule at the head of the several series in the general Table determines the quantivalence of each series of elements under it. When my first paper on atomic weights was published the only member of the series $H 7n$ known to be heptavalent was manganese, but I therein stated that the relation of this element to the iron group indicated a much higher quantivalence for the other members of this series than had hitherto been accorded to them. MM. Hautefeuille and Chappuis have since formed pernitric acid, which indicates a higher quantivalence for nitrogen than had previously been obtained for this element*; and more recently MM. Debray and Joly have shown that ruthenium (Ru) is heptavalent by the formation of the heptarutheneates of potassium and sodium, which have many points of resemblance to the heptamanganates †.

The remarkable resemblance which the members of the iron group have to each other while their atomic weights are nearly the same, has long been a subject of interest to philosophical chemists, and if the views which I have enounced respecting the formation of elementary species be correct, the cause of these resemblances admits of a possible explanation.

From the great abundance and wide distribution of iron in nature, it is probable that the vapour of this element would form an atmosphere of considerable depth; the upper and lower regions of which, by differences of pressure and temperature, might produce allotropic varieties before a definite change to the next higher members in the series occurred. When once varieties of an element were formed, these varieties would be propagated through successive condensations into the next higher members of the series, just

* *Comptes Rendus*, xciv. pp. 1111, 1306.

† *Comptes Rendus*, cvi. pp. 1494, 1888.

as they are found in the palladium and platinum groups of metals. Chemists have already observed that each of the metals of the palladium group appears to be more especially correlated with some particular member of the platinum group, and all are found associated together naturally in the metallic state. M. Sergius Kern, a Russian chemist, has discovered a new metal with an approximate specific gravity of 9.39 which he classifies with the platinum, and has given to it the name of Davyium*. The low specific gravity of this element indicates it as the fourth member of the palladium group of metals, as shown in my general Table.

The chief properties which distinguish the elements of the series $H7n$ are their high fusing-point and their passivity in the presence of ordinary reagents, to which iron, under peculiar conditions, forms no exception.

Although gold in some recent classifications of elements has been separated from the platinum metals, yet, in its primary qualities, it exhibits closer analogies with them than with the members of any other series, and there is no other place vacant in the groups which an element with the atomic weight and physical properties of gold would fit. The constant association in nature of quartz, hematite, and specular iron ores with gold and platinum is a fact fully recognized by chemical geologists †, and confirms the positions assigned for Si, Fe, and Au in the table as forms of $H7n$.

Although I have designated the highest members of the series $H7n$ as the platinum group, yet if the small differences in their atomic weights and physical properties admit of explanation by the assumption of their being allotropic varieties of each other, then gold, palladium, and iron may stand at the head of their respective groups and determine the species to which the varieties belong. It is no objection to the theory of the members of the respective groups being varieties of each other that they cannot by any known power of analysis be resolved into their primaries, as the same objection would apply to the natural varieties of organic species determined by naturalists.

The arbitrary policy of several writers in doubling the atomic weights of four of the gaseous members of the series $H7n$, viz.: neon, argon, krypton, and xenon (notwithstanding that the atomic weights of nitrogen, hydrogen, oxygen, and

* *Comptes Rendus*, lxxxv. pp. 72, 623, 667.

† Bischoff's 'Chemical and Physical Geology,' iii. p. 534. Cavendish Soc. Works. Murchison's 'Siluria,' chap. 17, pp. 433-439.

chlorine are the same as their specific gravities at ordinary temperatures) has induced me to review the multiple relations of the series of elements $H7n$ with the following results :—

1. Ne 7 + Ar 21 = $28 \div 2 = N$ 14
2. Ne 7 + Si 35 = $42 \div 2 = Ar$ 21
3. Ar21 + Xe 63 = $84 \div 2 = Kr$ 42
4. N 14 + Fe 56 = $70 \div 2 = Si$ 35
5. Ne 7 + Pd105 = $112 \div 2 = Fe$ 56
6. N 14 + Au196 = $210 \div 2 = Pd$ 105
7. Ne 7 \times 28 = Au196
8. Ne 7 \times 9 = Xe 63

An examination of the above Table shows (1) that no fewer than six triads are formed in the series, in which the sum of the atomic weights of the extreme members is double the atomic weight of the means, and all are multiples of Ne7. Triads of atomic weights have been fully recognized by Dumas, Faraday, and other philosophical chemists as indubitable evidence of community of origin, of transmutation, and important factors in the classification of elementary substances. (2) That the atomic weight of silicon (35) follows naturally in the series, and the lesser values Si 21, and Si 28, find no place in the table. (3) That if the atomic weights of Ne, Ar, Kr, Xe were doubled, it would be necessary to double those of N, Si, Fe, Pd, Au, and other members of the series, which is obviously absurd.

As the four new elementary gases have no chemical properties their specific gravities are necessarily substituted for atomic weights. The experimental determinations of their respective densities differ slightly from my table owing to the difficulty of separation from each other, probably from other causes which it is unnecessary on this occasion to indicate. In the interests of science, however, it is incumbent on me to say that no teacher of natural science, with the above table before him, is at liberty to double the atomic weights of the inert gases of the series $H7n$ without violence to his moral intelligence and lasting injury to the ingenuous student who looks up to him for guidance and instruction. These remarks are equally applicable to the doubling of the atomic weight of helium, which element has been separated from the series $H2n$, and grouped with Ne, Ar, Kr, Xe, solely on account of its chemical inertness, the five elements having no other rational classification.

It is a common error to assume that discoverers in various departments of science are, necessarily, authorities on the co-ordination of the subject of their discoveries with the general properties of bodies, and with the real nature of things. Thus (1) Peligot adopted 120 as the atomic weight of uranium, and Stromeyer 56 for cadmium, the modern determinations for these elements being 240 and 112 respectively. (2) Scheele's oxymuriatic acid was shown by Davy to be elementary chlorine. (3) Platinum was identified by its Brazilian discoverer with silver, and derived its name from that metal. Many similar instances may be adduced from other departments of the natural sciences. It will be sufficient to mention in this connexion the discovery and first appearance of Saturn's rings, the supposed cometary nature of the planet Uranus, and the landfall of Columbus.

Helium, as will be seen in several of my papers, is the typical element of the series $H\ 2n$, with an atomic weight of 2 ($He=2$) as shown in the following table (p. 738). This number has been adopted by French chemists in the table of atomic weights published in the *Annuaire du Bureau des Longitudes*.

Further inspection of the Table will show that, in consequence of the law of multiple proportions by which the atomic weights of the series are determined, there is a common difference of 23 between the atomic weights of the series Hn (commencing with K) to the final member Hg. In like manner there is a common difference of 24 in the strictly parallel series $H2n$. The regular parallel differences between the atomic weights of members at the head of both series are equally remarkable.

I have discussed in former papers the alternation of light and heavy metals in regular order observable in each of these series, and have put forward suggestions as to its possible cause in my first papers on the "Origin of Elementary Substances," published by the Society in 1878 and 1887.

Radium (as was indicated in my Table of Elements some years previous to its discovery) is one of the synthetic transformations of helium in the series $H\ 2n$, and is the next higher member to barium of the alkaline-earth metals. This place has since been assigned to radium by Mme. Curie, but with an erroneous atomic weight and specific gravity; as will be seen by comparison with the similar properties of the other members of the same series (*Philosophical Magazine*, February 1908).

H_n .	H_{2n} .
$H = 1$ Diff. - 6	$He = 2$ Diff. - 6
$0 \cdot 0 \cdot 7$ Li = 7 0.59† 7* -16	$0 \cdot 0 \cdot 8 = Be = 8$ 1.64 9.2 -16
$1 \times 23 \cdot 0 = Na = 23$ 0.98 23 -16	$1 \times 24 - 0 = Mg = 24$ 1.74 24 -16
$2 \times 23 - 7 = K = 39$ 0.86 39 -23	$2 \times 24 - 8 = Ca = 40$ 1.8 40 -24
$3 \times 23 - 7 = Cu = 62$ 8.9 63.3 -23	$3 \times 24 - 8 = Zn = 64$ 7.2 65 -24
$4 \times 23 - 7 = Rb = 85$ 1.52 85 -23	$4 \times 24 - 8 = Sr = 88$ 2.54 87.5 -24
$5 \times 23 - 7 = Ag = 108$ 10.6 108 -23	$5 \times 24 - 8 = Cd = 112$ 8.69 112 -24
$6 \times 23 - 7 = Cs = 131$ 1.88 132 -23	$6 \times 24 - 8 = Ba = 136$ 3.75 137 -24
$7 \times 23 - 7 = X = 154$ 12.2‡ -23	$7 \times 24 - 8 = X = 160$ 10.13‡ -24
$8 \times 23 - 7 = X = 177$ 2.2‡ -23	$8 \times 24 - 8 = Ra = 184$ 4.8‡ -24
$9 \times 23 - 7 = Hg = 200$ 13.6 200	$9 \times 24 - 8 = Pb = 208$ 11.44 207

* Accepted Atomic Weights. † Specific Gravities. ‡ Estimated.

Helium (H_2) is also shown in the paper of 1878* as the analytic transformation ultimate of radium and other members of the series H_{2n} .

* Proc. Manchester Literary and Philosophical Society, xvii. p. 194 (1878); Memoirs, xxx. (1887); Chem. News, xxxviii. (1878).

The positions of helium and neon in my general Table of Elements, as the transformation ultimates of the series $H2n$ and $H7n$ respectively, are further interesting in connexion with the recent announcements that these elements have been found in glass vessels in which they had no previous existence*. Now, assuming the reality of these observations, the phenomena not only admit of explication from my classification of the elements, but also account for the discordant results obtained by the experimenters engaged in the research.

Several significant facts were brought out by the investigators during their researches, viz.:—the use of old X-ray tubes, bare glass tubes, and glass wool, from all which neon and helium were obtained. One of the investigators could only find neon as a transformation product, while others, working independently, found helium alone, and in other cases a mixture of both gases.

These results were of sufficient interest to induce me to ascertain the composition of various glasses used in the arts, from which the following are selections †:—

1. Baryta flint glass Si, Ba, K.
2. Ordinary flint glass Si, Pb, K.
3. Plate and Window glass . . Si, Ca, Na.
4. X-ray glass Si, B, Na.

All the above glasses, as will be seen, have silicon (Si) as their principal constituent, the transformation ultimate of which is neon.

The next constituents of the first three glasses, barium (Ba), lead (Pb), and calcium (Ca), are members of the series $H2n$; the transformation ultimate of which is helium.

The alkali metals, sodium (Na) and potassium (K), as will be seen, are constituents of nearly all glasses, and their transformation ultimate, with other members of the series Hn , is hydrogen. Considering the wide diffusion of this element, the transformations of Hn when actually effected would be difficult to demonstrate. One of the two principal lines in the spectrum of thallium was masked completely by hydrogen C of atmospheric air for more than thirty years, when I discovered it in the arc spectrum while engaged in another research ‡.

As the transformation of radium into helium was first

* 'Nature,' February 13; Chem. News, February 14, 1913.

† Thorpe's Dict. of Applied Chemistry, Article—Glass.

‡ Proc. Roy. Soc. 1893.

effected, indirectly, through its hydrated halogen and oxygen combinations in aqueous solutions, so would the anhydrous oxides of other members of the series $H\ 2n$ (and of other series) be resolved into their ultimates through the medium of their silicates, acting as solutions, during the process of transmutation.

All the silicates of the series $H\ 2n$, and some of other series, are easily vitrified in small quantities in laboratory crucibles and appliances. Their spectra can then be examined during electrification in tubes (under suitable conditions of temperature and pressure) for the discovery of new elements and the identification of those already known.

It may be laid down as a canon of chemical science, that the members of any natural series of elements are never transformed into the members and ultimates of any other series. Thus neon is the permanent transformation ultimate of the series $H\ 7n$; just as helium is the fixed ultimate of the series $H\ 2n$. Hence, also, helium and neon will be evolved from the vitrified silicates of calcium and barium. By the substitution of sodium and potassium for calcium and barium in their vitrified silicates, the transformation products would be neon and hydrogen, but without helium*.

LXII. *Measurements on the Earth's Penetrating Radiation with a Wulf Electrometer.* By Prof. J. C. McLENNAN and Mr. A. R. McLEOD, *University of Toronto* †.

I. *Introduction.*

IN a paper by one of us in the *Phil. Mag.* of Sept. 1912, the results were given of a number of observations on the intensity of the earth's penetrating radiation taken, with a C. T. R. Wilson gold-leaf compensating electrometer, at a number of points on the sea and also at a number of places on land on both sides of the Atlantic. These results showed that while at a number of places in England and in Scotland and in the open at and near Toronto, the number of ions generated per c.c. per sec. in a zinc vessel containing air and hermetically sealed, was between eight and nine, the number

* During the course of an elaborate analysis of many fine crystals of uraninite which led to the discovery of terrestrial helium, Dr. Hillebrand has shown (*Bulletin U. S. Geological Survey*, 1889-90) that this mineral, from various localities, contains from 3 to 10 per cent. of lead (Pb), the transformation ultimate of which is helium, as shown in my Tables, and is not, consequently, the ultimate of uranium (U).

† Communicated by the Authors.

generated in the same vessel on a steamer on the Atlantic was only about 6.03 ions per c.c. per sec.

The readings on the Atlantic were taken with difficulty on account of the continued oscillation impressed upon the gold-leaf system by the swaying of the steamer. As a result these readings were not considered to have the same reliability as those taken on land at the different points of observation.

With a view to obtaining more reliable observations on the surface of the ocean a second set of readings was taken when crossing the Atlantic in September 1912, and again a third one when crossing in June of the present year. This time, however, a Wulf bifilar electrometer was used. The instrument behaved admirably, and with it readings were taken on board ship with the same ease as on land.

II. *Apparatus and theory of Instrument.*

The form of the instrument used is shown in fig. 1. It

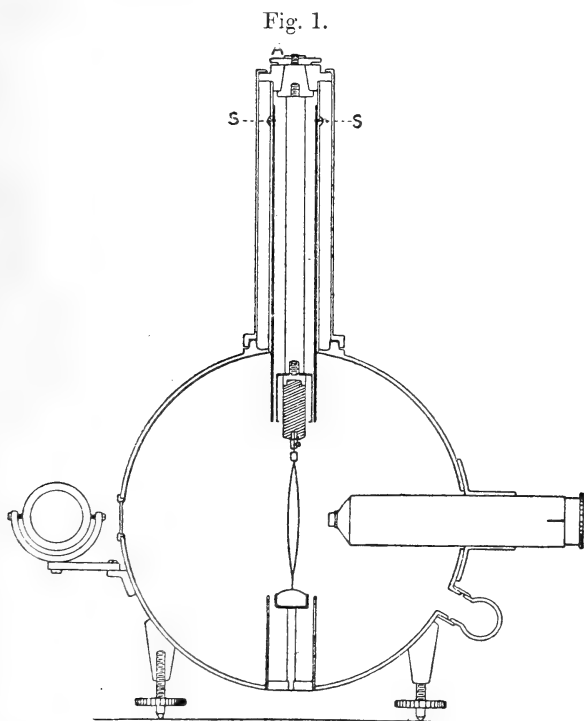

consists of a cylindrical receiver of zinc provided with plane sides which had a capacity of about two litres. The electrical

system consisted of two conducting fused-quartz fibres attached at their upper ends to an insulating support and at their lower ends to a cross fibre also of fused quartz under tension. This cross fibre was attached to an insulating support as shown in the figure. The instrument was provided with a metal tube *ss*, which could be slid down over the electrical system. The use of this sliding tube was to limit the volume from which ions could be drawn to the fibres to as low a value as possible. With the tube raised the effective volume as given by the makers was 2021.1 c.c., but with it lowered the effective volume was only 31.5 c.c.

The fibres were illuminated by light thrown into the instrument by a mirror through a window, and the readings were taken with a microscope provided with a scale. The air in the receiver was kept dry with a small quantity of sodium carried in a small receptacle attached to the body of the instrument. The electrical system in practice was charged by means of a Zamboni pile through the intermediary of an insulated metallic sound which passed through the case, and which could be turned when desired so as to come into contact with a metal piece which connected the fibres to their upper insulating support. All the openings into the receiver, with the exception of the covering tube A, were either closed by soldered contacts or by fluted joints provided with leather washers. The lower end of the covering tube A had a ground conical surface, and when in position was held hermetically connected to the body of the instrument with a shoulder piece provided with a thread. The instrument was provided with a covering tube for the microscope and a cover plate for the window. Both of these could be screwed tightly against leather washers.

When all the openings into the receiver were carefully closed the instrument was both water-tight and air-tight.

The electrical system was calibrated in the ordinary way, and by means of a calibration curve the readings were transcribed from changes in deflexions into potential falls.

The capacity of the electrical system was 1.04 cm.

The theory of the instrument is as follows:—

Let Q be the loss of charge observed in one second and A the part of Q due to the leak over the insulating supports.

Let V be the effective volume with the tube *ss* up, and V_1 its effective volume with the tube down.

Then $Q = A + BV$ where B is a constant,

and $Q_1 = A + BV_1$,

or

$$A = \frac{VQ_1 - V_1Q}{V - V_1},$$

$$= Q_1 - \frac{V_1}{V}Q$$

if $\frac{V_1}{V}$ is a small quantity.

The charge on the ions generated per cubic centimetre per sec. is then given by

$$B = \frac{Q - Q_1}{V - V_1}.$$

Let now Δv be the loss in voltage per hour with the tube *ss* up, and Δv_1 with it down.

Then if *C* is the capacity of the system

$$Q = \frac{C\Delta v}{300 \times 3600}, \text{ i. e. } = \frac{1.04\Delta v}{300 \times 3600}$$

in the present case, and

$$Q_1 = \frac{1.04\Delta v_1}{300 \times 3600}.$$

From this it follows that *B* is given by

$$B = \frac{1.04(\Delta v - \Delta v_1)}{300 \times 3600(V - V_1)}.$$

Finally, the number of ions generated per sec. per c.c. if saturation voltages are used is given by $N = \frac{B}{e}$, where *e* is the charge on an ion in electrostatic units, *i. e.*

$$N = \frac{1.04(\Delta v - \Delta v_1)}{300 \times 3600(V - V_1)e},$$

or, if *V* be taken as 2021.1 c.c., *V*₁ as 31.5 c.c., and *e* = 4.75 × 10⁻¹⁰,

$$N = \frac{1.04(\Delta v - \Delta v_1)}{300 \times 3600 \cdot (2021.1 - 31.5) \times 4.75 \times 10^{-10}},$$

or

$$N = 1.02(\Delta v - \Delta v_1),$$

i. e. the number of ions generated in the receiver per cubic centimetre per sec. is equal to 1.02 times the difference in the drops in voltage per hour observed with the tube *ss* up and down.

A set of readings taken with instrument at Cambridge, England, is given in Table I., and a curve representing them

TABLE I.

Time in minutes.	Potential of electrical system.
0	221 volts.
86	209
164	197.9
257	185.5
351	172.1
442	159.5
495	151.3

Fig. 2.

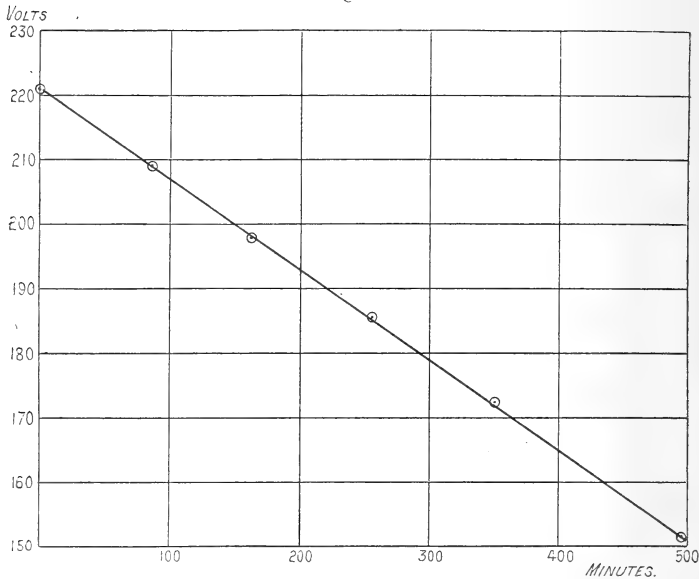

is shown in fig. 2. These serve to exhibit the constancy of the ionization produced by the penetrating rays at the point of observation for a period of time extending over eight hours.

III. *Measurements on the Atlantic Ocean.*

The readings taken on the two voyages referred to above are given in Table II.

TABLE II.

Measurements on the ionization in a closed vessel taken on a steamer on the Atlantic Ocean with a Wulf electrometer.

VOYAGE NO. I. ON SS. 'HESPERIAN.'		
Sept. 14, 1912.....	Firth of Clyde	4.4 ions per c.c. per sec.
15, ,,	On the Ocean	4.2
16, ,,	,, ,,	4.5
17, ,,	,, ,,	4.1
18, ,,	,, ,,	4.3
19, ,,	,, ,,	4.3
20, ,,	Off Belle Isle	4.1
21, ,,	Off Romouski.....	4.0
22, ,,	River St. Lawrence, near Quebec.....	4.5
		Mean = 4.3 ions per c.c. per sec.
VOYAGE NO. II. ON SS. 'MEGANTIC.'		
June 24, 1913.....	River St. Lawrence	5.57 ions per c.c. per sec.
25, ,,	River and Gulf of St. Lawrence.....	5.26
26, ,,	Gulf of St. Lawrence and Atlantic	5.07
27, ,,	Atlantic Ocean	4.64
28, ,,	,, ,,	4.80
29, ,,	,, ,,	4.41
30, ,,	,, ,,	4.20
July 1, ,,	Off North Coast of Ireland and Irish Sea	4.44
		Mean of last three readings = 4.35 ions per c.c. per sec.

The readings taken on the first voyage, it will be seen, are quite regular and uniformly low. Their average was 4.3 ions per c.c. per sec. The lowest reading, 4.0 ions per c.c. per sec., was that taken on Sept. 21, the day on which the steamer was passing from the Gulf into the River St. Lawrence.

The readings taken on the second voyage it will be seen started at 5.57 ions per c.c. per sec. and finally dropped to about 4.35, which is the mean of the readings taken on the last three days. The high initial readings were probably due to radio-active deposits which settled on the ship when in port at Montreal, but it is interesting in this connexion to note that no important drop was observed in the ionization when the steamer left port in the first voyage. If the prevailing winds at Glasgow were south-west ones it might afford an explanation, in part at least, of this result.

It is interesting also to note that the final readings on the ss. 'Megantic' were practically the same as those taken during the voyage of the 'Hesperian.' This would go to show that the contribution to the ionization by radiation from the materials and contents of the steamer was practically the same for both ships. Further, as Simpson and Wright* had previously obtained 4.1 ions per c.c. per sec. for the ionization in a closed zinc vessel on a small skiff on the Atlantic, this would go to show that the amount contributed to the ionization by radiation from the ship was inconsiderable.

The mean of the readings taken on the ocean with the Wulf electrometer, viz. 4.33 ions per c.c. per sec., it will be seen was 1.7 ions per c.c. per sec. less than the mean of the readings previously taken with the Wilson electrometer, and in view of the accuracy and ease with which the readings could be made with the Wulf instrument, the value 4.33 ions may be accepted as closely representing the true value of the ionization obtainable on a large ship on the sea.

IV. *Measurements on Land.*

At various times previous to and succeeding the two voyages, as well as at times in the intervals between them, readings were taken with the instrument at a number of points at or near Toronto and also at a number of places on the other side of the Atlantic. These are summarized in Table III., and along with them are given the readings taken at a number of places with the Wilson Compensating Gold-leaf Electrometer.

From the numbers given it will be seen that the readings with both instruments were practically the same at Midlothian, Scotland, at Cambridge, England, and at the Physical Laboratory, Toronto. This, combined with the

* Simpson and Wright, Proc. Roy. Soc. Ser. A. vol. lxxxv. p. 175 (1911).

TABLE III.

Measurements of penetrating radiation at Stations on Land.

OBSERVATION POINT.	Values of "q" = $\left\{ \begin{array}{l} \text{the number of ions pro-} \\ \text{duced per sec. in air} \\ \text{at atmospheric pres-} \\ \text{sure by the pene-} \\ \text{trating radiation.} \end{array} \right.$	
	Wulf Electrometer.	Wilson Electrometer.
Braunschweig, Germany	8.1	...
Midlothian, Scotland	9.0	8.32
Cambridge, England, I.	9.03
II.	8.26	...
The "Physical" Laboratory, Toronto	8.62	9.08
The Meteorological Observa- tory, Toronto	8.88
The University Lawn	8.1	...
In a residence in Toronto made of red brick	9.47	...
In a deep pit in the Lorraine Shale in a brick-yard at Toronto	12.0 to 14.8	...
Close to walls of glacial clay deposits	8.84	...
On layer of sand and clay, 2.5 metres thick, above pit of shale	8.67	...
On surface-layer of sandy loam about 33 metres from entrance to opening in clay deposits	6.83	...
On the surface of Lake Ontario	4.93	4.46
Eight metres under the sur- face of Lake Ontario at a point where it was twenty metres deep	4.77	...
Mean of measurements taken on the Ocean	4.33	6.03

high value obtained for the ionization on the ocean with the Wilson electrometer, goes to show, as one might have anticipated, that it is quite impossible to take readings on ship-board with an instrument provided with a gold-leaf system with any degree of accuracy.

In the course of the observation at Toronto values between 9 and 10 ions per c.c. per sec., with a mean of 9.47, were obtained when the readings were taken in a residential building the walls of which were constructed of red brick.

As values close to 8.62 for "q" were always obtained in

the Physical Laboratory, which was constructed of stone and white brick, and as these values were uniformly lower than those obtained in the residence referred to, it was thought that possibly the higher values might be due to a measurable excess of radio-active matter contained in the bricks of the residential structure.

As the bricks for both structures were made from different deposits in the same brick-yard a series of measurements was made in the neighbourhood of these different deposits, and it was found that the surmise was correct.

In this particular brick-yard the surface-layer is a sandy loam about one metre thick; below these there is a series of strata of glacial clays, each stratum ranging from 4 to 10 metres in thickness. Below the clay is a deposit of Lorraine shale some 250 metres in depth. This brick-yard, which has been worked for over fifty years, now consists of a great opening in the face of a hill and a huge cylindrical cavity in front of this opening and extending down into the shale. The depth of the cavity at present is about 25 metres and the length of its diameter is about the same. The sides of the opening in the face of the hill as it stands consist of a series of terraces, each of which consists of one particular deposit of clay. This system of terraces in the clays, it will be seen, provided an excellent means of investigating the radiation from each deposit in turn, and when readings were taken on each terrace it was found that these gave values for "q" extending from 8 to 9 ions per c.c. per sec. with a mean value of about 8.84.

In the shale pit, however, much higher readings were obtained. These were taken at different points on the base of the pit and on a number of ledges which were accessible. The values found for "q" in the shale-pit ranged from 12 to 14.8 ions per c.c. per sec., the lower values being obtained when the stations were taken at points near surfaces which were weathered, and the higher ones when the observation stations were close to places where the surface of the shale had been recently exposed.

As an illustration of how definitely the comparatively strong radiation from the shale producing the high ionization was localized, a particular measurement may be cited.

The stratum immediately above the shale consisted partly of sand and partly of clay. At one particular point this layer was about 2.5 metres thick, and it extended up to the face of the opening of the pit in the shale. The reading obtained on this layer at a point about 6 metres back from the edge was only 8.67 ions per c.c. per sec., which shows

that this layer of sand and clay acted as a screen and cut off entirely the excess radiation from the shale underneath.

Another illustration of a screening effect was obtained in the reading taken on the surface of the ground back about 30 metres from the opening into the clay bank. At this station no direct radiation could reach the instrument from the shale, and the radiation from the clay deposits could only reach it after passing through the surface-layer of sandy loam, which was about one metre thick. The reading at this station was only 6.82 ions per c.c. per sec. From this low value it was evident that the sandy loam contained considerably less active matter than the clays and also that it acted as a screen to absorb the radiation coming from the clay lying below it.

It may be added, in regard to these various deposits, that it was the shale which was used in making the red-coloured bricks and the clays in making the light-coloured ones.

V. On the Penetrating Radiation from the Atmosphere.

In several previous communications by one of us* and by C. S. Wright †, attention has been drawn to the fact that the ionization in a closed vessel is very much less over the water of Lake Ontario than it is at points on the neighbouring land. Further, in measurements made on the lake with a zinc receiver of about 27 litres capacity and a Wilson electrometer the value of "q" has been shown to be about 4.46 ions per c.c. per sec.

On repeating these measurements with a Wulf electrometer the mean of a number of sets of observations gave a value of 4.93 ions per c.c. per sec. for "q," which is slightly higher than the value previously obtained with the larger receiver. These observations were carried out on a small skiff about 2 kilometres from the shore, at a point where the water was about 20 metres deep.

In a second set of observations made at this point on the skiff the electrometer was placed for protection in a metal box of aluminium-bronze with walls a little over one centimetre thick. In these measurements the value of 4.81 ions per c.c. per sec. was obtained for "q".

In a third set the metal box containing the electrometer was lowered into the water to a depth of about eight metres, and in these experiments the average reading obtained was 4.77 ions per c.c. per sec. From this result it would appear

* *Phys. Rev.* vol. xxvi. No. 6, p. 526 (1908).

† *Phil. Mag.* ser. 6, No. 17, p. 295 (1909).

that the radiation coming from the air above the lake did not contribute any more to the ionization in the electrometer than about $\cdot 16$ ion per c.c. per sec.

In attempting to ascertain the contribution made to the ionization in a closed vessel by radiation coming from active matter in the air above the land, measurements are complicated by the effect of radiation from active matter in the soil and from active matter deposited on the surface of the ground from the atmosphere. It would seem, however, since the measurements described above were made at a point only about 2 kilometres from the shore, that the contribution made to the ionization in air in a zinc vessel by radiation from the active matter in the air over the land near Toronto cannot be very far from $0\cdot 2$ ion per c.c. per sec.

VI. *Residual Ionization.*

From the measurements which have been described above, it would appear that the lowest value obtainable for the ionization in a closed zinc receiver, at points near the surface of the earth where the intensity of the penetrating radiation may be considered to have a minimum value, approximates to 4 ions per c.c. per sec. This, it will be remembered, was the mean value obtained for q from the measurement made on the s.s. 'Hesperian' on Sept. 21st, 1912, and it was also practically the value found for " q " by Simpson and Wright* on a skiff on the Southern Atlantic.

To what, then, is this residual ionization due? As an attempt to answer this question the following experiments may be of interest. In these the electrometer was placed in the aluminium-bronze box used in the experiment under water on the lake, and this box was suspended in a moderate-sized tank which could be filled with water and which was situated in the attic of the Physical Laboratory at Toronto. Readings were taken of the ionization in the electrometer when the tank was empty and also when it was filled with water. With the tank empty the reading was $8\cdot 05$ ions per c.c. per sec., and with it filled the reading was $5\cdot 82$ ions per c.c. per sec. The dimensions of the box were $36 \times 22 \times 18$ c. cm., and those of the mass of water surrounding it were $121 \times 90\cdot 7 \times 83$ c. cm. This, it will be seen, gave roughly a mean of $36\cdot 5$ cm. as the thickness of the water-screen surrounding the box.

Assuming the water to contain no radioactive matter, we

* *Loc. cit.*

may suppose the ionization in the electrometer to be given by

$$(I - x) = (I_0 - x)e^{-\mu d},$$

where μ is the coefficient of absorption of the penetrating radiation, d the thickness of the water-screen, and x the ionization in the electrometer which is not due to the penetrating radiation. We have then

$$(5.82 - x) = (8.05 - x)e^{-36.5\mu}.$$

For soft gamma rays Rutherford * gives the value .0558 for μ and for harder rays the value .0472. The measurements of Hess † at Vienna on the absorption of gamma rays by air also lead to a value for μ for water of .0413.

Applying these values we find the value of x to be as follows :—

μ .	x (ions per c.c. per sec.).
.0558	5.48
.0472	5.33
.0413	5.19

In so far as these measurements go then, it would appear that 5.19 ions per c.c. per sec. is the lowest value one should have expected to get for the ionization in the zinc vessel when all the penetrating radiation was cut off.

In view, however, of the fact that 4 ions per c.c. per sec. was obtained experimentally, the above experiments can only be considered as giving a roughly approximate result.

They serve to show, however, that unless there is present at the surface of the earth a radiation of a much higher penetrating power than any yet observed, there must be a residual ionization in air confined in a zinc vessel (of about 4 ions per c.c. per sec.) when it is not traversed by any radiation from an external source.

It would seem, therefore, that this residual ionization must be due either to radiation from a minute quantity of radioactive matter still remaining in the zinc of which the receiver is made, or to a process going on in the gas which results in what may be called a spontaneous dissociation of the molecules.

If the residual effect were due to active matter in the walls of the receiver one should expect that the value obtained for "q" would increase if the volume of the receiver were diminished. Since the value of 4.1 ions per c.c. per sec. was

* Rutherford, 'Radioactive Substances and their Transformations,' p. 266.

† Hess, *Phys. Zeit.* vol. xii. p. 998 (1911).

obtained for "q" by Simpson and Wright with a zinc receiver of about 27 litres capacity, and a value of 4 ions per c.c. per sec. by the writers with an ionization-chamber of the same metal of only 2 litres capacity, one is led to the conclusion that the experimental results obtained so far lend no support to the view that the residual ionization obtained in air confined in zinc receivers is due to a radiation emitted by the walls. It would be interesting, however, to see what resulted if receivers of still smaller capacity than two litres were used. On the other hand, it has been shown by J. J. Thomson *, and again recently by Langevin and J. J. Rey †, that one cannot account for this residual ionization by supposing it due to collisions between the molecules, for, on this hypothesis, the increase in ionization with a rise in temperature should be enormously greater than any increase which has been observed.

The writers wish to acknowledge their indebtedness to Messrs. P. Blackman, G. S. Campbell, and E. C. Henderson for their kindness in making corroborative measurements at various times during the investigation.

The Physical Laboratory,
The University of Toronto,
July 1st, 1913.

LXIII. *On a New Method of Determining the Horizontal Intensity of the Earth's Magnetic Field.* By WALTER A. JENKINS, M.Sc. (1851 Exhibitioner) ‡.

THE ordinary method for the determination of the horizontal component of the earth's magnetic field is somewhat lengthy and involves several troublesome corrections. The following method, while as accurate as the old one, possesses the very great advantage of involving no corrections.

The principle of the method is the production of a known field opposite to that of the earth's and twice its magnitude. The equality of the two fields—that due to the earth and that due to the combination of the earth's and the produced one—is determined by the equality of the times of vibration of the same magnet, when the applied field is off and on, and the applied field is determined by measuring the current producing it.

* J. J. Thomson, 'Conduction of Electricity through Gases,' 2nd ed., p. 294.

† Langevin & J. J. Rey, *Le Radium*, April 1913, p. 139.

‡ Communicated by Prof. W. M. Hicks, F.R.S.

In the experiment as actually carried out the field is produced by an accurately wound helix. In such a case the field at the centre is given by $4\pi nC \cos \alpha$, where n is the number of turns per cm. of the helix, C is the current in amperes, and 2α is the angle subtended by the diameter of the end of the helix at the centre of the helix.

It will be at once seen that the following corrections, necessary in the Magnetometer method, can be eliminated :

- (a) Correction of the time of swing owing to the vibration not being in an infinitely small arc.
- (b) Correction for the torsion of the fibre.
- (c) Correction for temperature alteration.
- (d) Correction due to the temporary increase of the moment of the magnet owing to its lying in the earth's field.

The conditions in the two parts of the proposed method are exactly the same, hence (d) does not enter, while (a) is made of non-effect by taking the initial arc of swing the same in each part of the experiment.

By turning the head supporting the suspension fibre through 180° the torsion when the magnet is vibrating in its reversed position is exactly the same as when it is vibrating under the influence of the earth alone, and therefore no correction is needed on account of (b). As will be shown later, the torsion may influence the result in another manner. (c) becomes of no account if the experiment is performed in a room kept at a fairly uniform temperature, for the experiment is not long. If it were found necessary, the requisite correction could easily be determined.

Preliminary experiments having shown that the method was practicable, apparatus was devised for carrying out the experiment in an accurate manner. The construction and working of the different parts will be described, then the conditions of accuracy discussed, and lastly the method of making the experiment will be detailed.

The Helix.

As the field at the centre is $4\pi nC \cos \alpha$, n must be quite definite and, if great accuracy is to be obtained, $\cos \alpha$ must be almost 1 in order to ensure the field near the centre being uniform. A helix of length 100 cm. and diameter 4 cm. gives $\cos \alpha = .9992$, and is therefore of suitable dimensions as will be shown later. A preliminary experiment was carried out using a helix of silk-covered wire wound on a copper tube 118 cm. long and internal diameter 4 cm. The results

were satisfactory ; but such a helix is subject to the following faults :—

- (a) Leakage of current through the covering of the wire owing to imperfection of insulation ;
- (b) Irregularity in the winding causing uncertainty in the value of “*n*.”

Both these errors would be eliminated by the following scheme :—Coat the tube with an insulating material and turn down to a perfect cylinder. Silver the surface and deposit copper electrolytically on the silvered surface. Now turn a screw-thread on the surface so as to give a helix of copper wire. If a suitable tube could be obtained it would be better to use one made of insulating material instead of coating the copper one. Owing to its being fragile, the use of an ebonite tube is not to be recommended, and as a copper tube is (a) easily obtained and turned to a perfect cylinder, (b) strong, (c) practically non-magnetic, it was decided to use such a tube and try the above suggested method of coating. Sulphur was first tried as the insulating material, but preliminary experiments with a tube 30 cm. by 2 cm. showed that it was unsuitable as it was (a) extremely difficult to apply to the copper tube, (b) difficult to turn a good screw-thread on the tube thus coated. Zylonite, a white viscous fluid, almost solid, which dries to a hard white insulating substance, was next tried. Preliminary experiments with a small tube were entirely satisfactory, excepting for the fact that air-bubbles were continually appearing even when the zylonite appeared to be set. Otherwise the zylonite satisfied all the conditions, but this defect caused its abandonment. At the time of writing the zylonite is perfectly hard and dry and would probably prove suitable. Experiments with ivoride and hard paraffin-wax showed their unsuitability, and, consequent upon these failures, it was decided to send the tube away and have a layer of ebonite placed upon it. This was done and eventually proved satisfactory. Two layers of ebonite were placed upon the tube, which was then turned down and a screw-thread turned on it. An experiment was then performed to test the accuracy of the cutting of the thread. The tube was fixed up so that it could be moved any desired distance in a direction parallel to its length. Two microscopes rigidly fixed at a certain distance apart were then focussed on the screw-threads, which were brightly illuminated. The intersections of the cross-threads of the microscope were focussed on the bottoms of two of the “V” shaped screw-threads. The number of screw-threads between the cross-wires was counted and found to be 41.

The tube was then moved parallel to its length, and at every part it was found that when the intersection of the cross-threads of one microscope was focussed exactly on the bottom of a thread, then the intersection of the cross-wires of the other microscope was likewise focussed, and everywhere there were 41 threads between. Hence the screw-thread had been very accurately cut.

To determine the number of threads per cm. the following experiment was performed:—Two travelling microscopes, placed at about 25 cm. apart, were focussed on the divisions of a standard metre-scale. The microscopes were so arranged that their direction of motion was parallel to the length of the metre-bar. This bar was then taken away and the helix, on a support resting on levelling-screws, was inserted in its place. The levelling-screws were adjusted until the surface of the helix was in focus in the microscopes. The microscopes were now moved slightly until the intersections of the cross-wires were focussed exactly between two particular turns of wire. The number of turns, between the two particular points on which the cross-wires were focussed, was counted. The solenoid was now removed and the standard metre-bar again inserted. A very slight longitudinal motion could be given to the length of the bar by means of a screw, turning in a fixed support, and pressing against the end of the bar.

The bar was adjusted by means of this screw until the cross-wires of one microscope were in focus on a division of the metre-scale.

The intersection of the cross-wires of the other microscope was not now in focus on a division of the scale, but, after reading its position with the vernier eyepiece, it was moved slightly until the intersection of the cross-wires was focussed on a division of the scale. The reading given by the metre-scale, plus the distance through which the microscope has moved, gives the distance containing the number of threads counted.

The 25 cm. between which the number of threads was counted was in the central portion of the solenoid, because of its being much more important to know the exact number of turns per cm. near the centre than at either end. The result was 18.8739 turns per cm.

Bare copper wire was now wound in the screw-threads and the wire was warmed slightly as it was wound on in order to make it grip the tube more efficiently and thus ensure accurate winding. The tube was slowly rotated in a lathe, and the wire, directed into the screw-threads with the hand, was heated by sending an electric current through it just

before it turned round the tube. Its passing through two wire brushes connected with an electric circuit enabled this to be done.

As it was not desirable to leave the helix open to the atmosphere, the tube was coated over with a solution of shellac. Best shellac was dissolved in pure methylated spirits, the solution filtered twice and then applied to the tube. Six coatings were given, and each one was allowed to dry before the next was applied. The wires could easily be seen through the transparent shellac, and the preceding experiment of determining the number of turns per cm. was easily carried out.

When the experiment is performed the current sent through the wire is about $\cdot 014$ ampere and, as will be seen later, no appreciable rise in temperature due to the passage of the current takes place. There is a possibility of leakage from turn to turn through the shellac, but as the latter is a good insulator the error caused by this is insignificant.

SUSPENSION OF THE MAGNET.

The central portion of the tube cannot be pierced to allow of a silk fibre being passed through it owing to the winding being thereby made uneven.

It was thought that it might be possible to make use of a system supported by a needle resting with its point on a polished glass surface, but it was found that however fine the needle-point was and however much the surface was polished, the system came to rest after about 8 minutes and, as this prevents an accurate determination of its period of oscillation being made, silk fibre was adopted. The whole of the suspending apparatus must be inside the tube and this necessitates a short fibre being used. The internal diameter of the tube is only 4 cm., so that the length of the fibre is limited to from 2 to 2.5 cm., as it is advisable to have the magnet in the vicinity of the axis of the tube. Further, the apparatus must be provided with a means of turning the fibre round through 180° , in order that the alteration in torsion, caused by the reversing of the magnet, might be eliminated. It must also be so arranged that it is easy to take the suspending apparatus out of the tube, in order to make any necessary alterations, such as the replacing of a silk fibre. The suspended magnet must also carry a mirror, by means of which, with the aid of an optical system, the determination of the period of oscillation can be made. All these are allowed for in the apparatus finally used, diagrams and descriptions of which follow.

Fig. 1 shows a vertical section of the apparatus supporting the magnet.

Fig. 1.

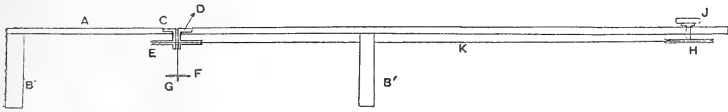

A is a thin brass rod to which the two split brass rings B and B' are brazed. These two split rings being elastic, serve the purpose of fitting the apparatus firmly to the inside of the solenoid tube. C is a small circular hole midway between the rings, and into this hole the actual suspending apparatus D fits. D is a piece of metal fitting into the circular hole, as shown, so as to permit of easy rotation. The pulley-wheel E is attached rigidly to D, and through both D and E a fine hole passes. The silk fibre passes through this hole and carries the magnet F and mirror G. To fasten the silk fibre a little melted wax was poured on the top of D, when the fibre had been threaded through the hole and adjusted to its proper length.

At the end of the brass rod remote from the split rings is a narrow slot through which the mechanism JH passes. H is a pulley-wheel which by the screwing down of J can be clamped tightly to the rod.

An endless cord K passes round the two pulley-wheels, and is kept taut by adjusting the position of the wheel H. The length of the apparatus is such that when the magnet is at the centre of the helix the pulley-wheel H, and the whole of the slot in which it can be moved, are outside the solenoid. When the cord K is taut, the silk fibre suspension-head can be rotated by turning the pulley-wheel H. A definite amount of torsion can therefore be taken away from or imparted to the fibre at any time.

The Magnet and its attachment to the Fibre.

The magnet itself consisted of several pieces of magnetized clock-spring about 2.8 cm. long and .25 cm. wide. These pieces of clock-spring fitted into a light aluminium holder to the upper surface of which the silk fibre was fastened by means of wax. A little manipulation was necessary in order to get the fibre attached directly above the centre of gravity of the holder.

The mirror was fastened to the aluminium holder directly under the point of suspension and perpendicular to the length of the magnet. Some little trouble was experienced in getting this latter condition accurately fulfilled, but its necessity is obvious. A silvered piece of microscope cover-glass served as a mirror.

Owing to the light weight which the fibre has to support an extremely fine one can be used. This is of great advantage, for it was found that unless the finest obtainable fibre was used the vibrations died out rather too quickly to allow of accurate observations of the time of swing being made. For this same reason the area of the surface of the mirror was made as small as possible.

In order to rid the fibre of torsion, the suspension mechanism was placed parallel to the earth's field, and a piece of brass, similar in weight to the magnet, inserted in the holder. It was now allowed to come to rest, and then the suspension-head was turned until its zero position was in a direction parallel to the earth's field. On placing the magnet in the holder no further twisting took place, and very little torsion was left in the fibre. When the suspension apparatus was in the solenoid, a strip of brass was screwed into the end of the tube in order to support the brass rod and prevent sagging.

Optical Arrangement for timing the Oscillations.

The period of vibration was found by means of the mirror attached to the magnet. Light from a Nernst lamp was reflected by a piece of plane glass, so that it passed down the solenoid tube and on to the mirror. A telescope was then focussed on the image of the filament of the Nernst lamp formed by the mirror. When the magnet oscillates, the image of the filament crosses the field of view of the telescope, and the exact moment of the image of the filament crossing the cross-wire of the telescope is easily noticed. The eye-and-ear method was used in the actual experiment. An ordinary lamp and clear glass scale were used in the preliminary observations, but it was difficult to pick out any particular scale-division when timing the oscillation, and the Nernst filament was found much more satisfactory. When the magnet is reversed, the image of the filament is still seen in the telescope, reflected from the back of the same mirror.

Placing of the Solenoid so that the Field given by the Helix is exactly parallel to the Earth's Field.

Fig. 2.

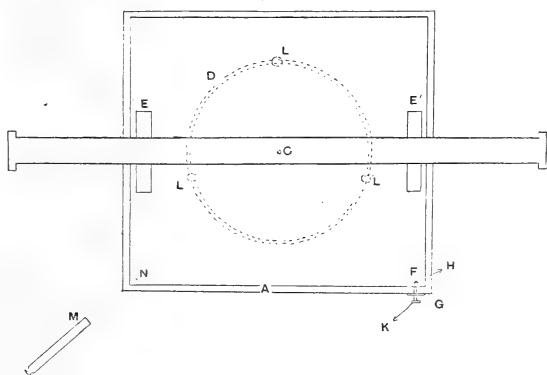

The solenoid tube rests symmetrically upon V's in the pieces of wood E, E' which are screwed into the drawing-board B in the positions shown.

At the centre of this drawing-board is a small circular hole C, through which passes a peg rigidly attached to the centre of the slightly larger drawing-board A. A large V-groove, circular in configuration, is cut into this lower drawing-board, and is represented in the diagram by the dotted circles D. Three steel balls, $\frac{7}{16}$ in. diameter, roll in this groove, and the drawing-board B rests on these steel balls. The apparatus rolls easily on the steel balls L L L, and as the peg at the centre of A fits exactly into the hole C, the motion is purely rotational. The slightest force applied to the drawing-board B is sufficient to rotate the apparatus. To keep the apparatus in a definite position, and to allow of very small rotations being made, the device shown at F was employed. G is a piece of metal firmly screwed into the side of the drawing-board A. Through this metal the large-headed screw K can be turned, and this screw is of such a length as to press against the side of the board B with its point and to allow of a rotation of several degrees. When the point of the screw is pressing against the drawing-board B, a slight turning of the screw will give a very small rotation. This, however, only allows the rotating of the solenoid in one direction, and to remedy this a small brass rod H was screwed into the board B and an elastic band passed round this and the piece of metal G.

Thus on withdrawing the screw K, the board is pulled back and kept tightly pressed against the point of the screw.

The final adjusting of the position of the solenoid so that it lies exactly parallel to the earth's field, is performed as follows. Adjust the optical system until the image of the filament of the Nernst lamp is coincident with the intersection of the cross-wires of the telescope. Send a current round the solenoid so as to produce a field, parallel to, and in the same direction as that of the earth. If now the solenoid be slightly out of its correct position the magnet will be deflected, and the image of the filament will no longer coincide with the intersection of the cross-wires of the telescope. If such be the case, rotate the solenoid until, on sending a current through the coil, no deflexion of the magnet occurs. By then sending a large current momentarily round the solenoid a very delicate adjustment of the position of the magnet can be made.

Electrical arrangement for sending and measuring the Current through the Solenoid.

Fig. 3.

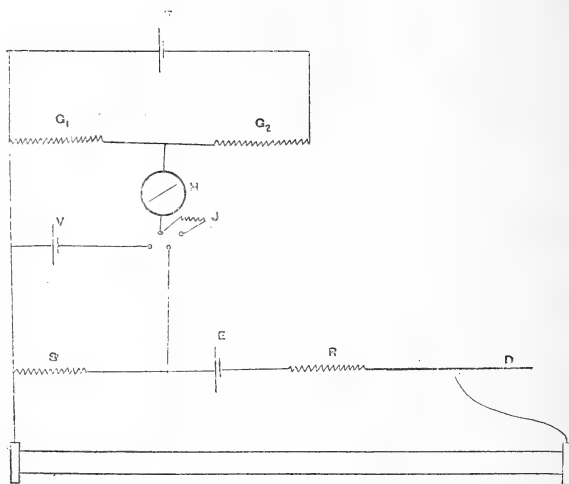

The lower half of fig. 3 depicts the apparatus used for sending and adjusting the current round the solenoid. A two-volt storage-cell E supplies the current which passes through a resistance-box R, a low resistance wire D, round the solenoid, and through the standard 10 ohms resistance S. The solenoid is connected to the low-resistance wire D by

means of a sliding contact, which allows of a minute alteration in the magnitude of the current being made.

The standard 10 ohms resistance is one by the Cambridge Scientific Instrument Co., and is provided with a calibration curve for alteration in resistance owing to change of temperature. The resistance itself is in oil contained in a small vessel which was kept in a bath of water at the temperature of the room. Thick copper leads dipping into mercury cups serve as a means of connecting the resistance with the other apparatus. The actual magnitude of the current is determined by measuring the drop in potential between the terminals of the standard resistance.

The upper portion of the diagram shows the method of measuring this drop in potential. The two post-office boxes $G_1 G_2$ form a potentiometer to the terminals of which a Leclanché cell F is connected. The cadmium cell V serves to standardize the Leclanché, the voltage of which is constant, for the total resistance in the post-office boxes never varies by more than 1 or 2 ohms from 10,000 ohms.

H is a sensitive mirror-galvanometer into the circuit of which a resistance J can be switched in, or out, at will by means of a three-way key.

The terminals of the standard 10 ohms resistance were connected to the post-office box potentiometer as shown.

The following is the method of making the measurement of the current round the solenoid.

The high resistance J and the cadmium cell are switched into the galvanometer circuit, and the resistance in G_1 is altered until no deflexion of the galvanometer mirror takes place. Whatever alteration in the resistance of G is made is compensated for by altering G'_2 so that resistance in G_1 plus resistance in G'_2 always equals 10,000. The high resistance J is now switched out of the galvanometer circuit and a more delicate observation made. It may not be possible to get an exact balance by keeping the sum $G + G' = 10,000$, and in this case $G + G'$ is altered very slightly, say to 10,002, so that accuracy may be ensured.

The cadmium cell is now switched out, and the drop in potential between the terminals of the standard 10 ohms resistance switched in. The previous process is now repeated until a balance is obtained. The calculation of the drop in potential between the terminals of the standard resistance is simple. The cadmium cell was immersed in water to keep its temperature constant, and as the makers provided a temperature calibration curve, its E.M.F. is known accurately. Immediately after the experiments it was sent to the National Physical Laboratory to be tested.

ACCURACY OF THE EXPERIMENT.

The different parts of the apparatus were designed with a view of attaining an accuracy in the value of H obtained, of 1 part in 10,000. Errors may be introduced by the following factors:—

- (1) The magnetic axis of the solenoid not being perfectly horizontal.
- (2) The magnetic axis of the tube not being perfectly parallel to the direction of H .
- (3) Irregularity in the winding causing the formula $H = 4\pi nC \cos \alpha$ to be at fault.
- (4) A longitudinal displacement of the magnet from the centre of the tube.
- (5) A residual torsion in the fibre.
- (6) Inaccurate determination of the period of oscillation.
- (7) Uncertainty in the determination of the current.
- (8) An error in the determination of the number of turns per cm.
- (9) Heating of the coil by the passage of the current.

How each of these factors will affect the current will now be discussed.

(1) *The magnetic axis of the solenoid not being horizontal.*

If the magnetic axis make an angle α with the horizontal, then the force acting on the magnet will be $\chi \cos \alpha$ instead of χ , and an error would be introduced in regarding it as χ . The ebonite-covered copper tube was turned down to a perfect cylinder in a reliable lathe, and as the cutting of the screw-thread was also done by a good machine, there is no danger of the helix not being a true cylindrical one. Such being the case, then the magnetic axis of the tube will be accurately parallel to the outside surface of the helix, and if the latter be horizontal, then the former will be also.

The setting of the solenoid in a horizontal plane is not difficult, and can easily be performed so as to make α negligible.

(2) *Error due to the magnetic axis not being parallel to the direction of H .*

The condition to be fulfilled in order that this factor shall be of non-effect is that $\cos \alpha = 1$ shall be correct to at least 1 part in 100,000, where α is the angle between the two directions. The following experiment was carried out in

order to ascertain the accuracy with which the adjustment of the position of the solenoid could be made.

The arrangement used is depicted in figure 2. Two vertical copper wires were fixed, one at N and the other at C, the point round which the apparatus rotates. A microscope M was arranged so that its length was in the same straight line as the wires, and the scale in the eyepiece was focussed on the copper wire N. The number of scale-divisions per millimetre was determined and the slightest motion of the wire N could therefore be accurately measured. The distance through which the wire N moves divided by the distance between the two wires at N and C gives the angle of rotation. By this means it was found that the screw arrangement at F, G, H, K was sensitive enough to rotate the apparatus through an angle as small as $\sin^{-1} \frac{1}{3000}$. The solenoid tube's position was now adjusted until, on sending a large current through the helix, so as to produce a field in the same direction as the earth's, no deflexion of the magnet took place.

The magnetic axis of the solenoid is now, as far as the delicacy of the experiment will allow, exactly parallel to the earth's field. The image of the Nernst lamp filament was now coincident with the intersection of the cross-wires of the telescope viewing the mirror on the magnet. The table was now rotated until on sending a current through the solenoid the image of the filament was displaced through about 1 mm. The angle through which the table had been rotated was measured by means of the copper wires and microscope, and found to be $\sin^{-1} \frac{1}{616}$.

As a movement of much less than 1 mm. could easily have been noticed it will be seen that the adjustment can be made with much greater accuracy than the other quantities can be determined, as $\sin^{-1} \frac{1}{616}$ gives $\cos \alpha = 1 - 2 \times 10^{-6}$ or an error of 2 in 10^6 .

(3) *Irregularity in the winding causing the formula*
 $H = 4\pi nC \cos \alpha$ *to be at fault.*

Any irregularity in the winding near the centre will have a much greater effect than any irregularity near the ends. In the examination of the screw-thread it was found that between two fixed microscopes the number of threads was perfectly constant. The distance between the microscopes was, however, about 3 cm., and it is quite possible that while the sum total of the threads in any 3 cm. is constant,

yet certain individual threads might be displaced. The number of threads per cm. is about 19, and as the cutting of the thread was done by a good machine it is certain that no thread will be displaced from its true position by more than .1 mm., that is $\frac{1}{5}$ of the distance between any two consecutive threads. Suppose such a deviation to occur in the thread at the centre, *i. e.* at the point where it will have the greatest effect.

The field due to a circular current at a point P on its axis is given by

$$H = 2\pi C r^2 / (r^2 + d^2)^{\frac{3}{2}},$$

where r is the radius of the circle and d is the distance of the point P from the centre of the circle.

Hence the field due to a single turn of the solenoid at the centre of the solenoid is given by

$$H = 2\pi C r^2 / r^3.$$

If the deviation is .01 cm. then we have

$$H = 2\pi C r^2 / \{r^2 + (.01)^2\}^{\frac{3}{2}},$$

and the error is given by

$$\begin{aligned} & \frac{2\pi C r^2}{r^3} \left\{ 1 - \frac{r^3}{\{r^2 + (.01)^2\}^{\frac{3}{2}}} \right\} \\ &= \frac{2\pi C r^2}{r^3} \left\{ 1 - \frac{1}{\left\{ 1 + \left(\frac{.01}{r}\right)^2 \right\}^{\frac{3}{2}}} \right\} \end{aligned}$$

$r = 3.13$ cm., the thick copper tube and ebonite coating making the external diameter much greater than the internal; and working this formula out we get

$$\partial H = \frac{2\pi C r^2}{r^3} \left\{ 17 \times 10^{-7} \right\}$$

or an error of 17 parts in 10^7 .

Thus we see that if each thread were displaced by .1 mm. the maximum possible error would be much less than 17 parts in 10^7 , as the effects of many of the displacements would cancel each other. The error caused by inaccurate winding is therefore a negligible quantity, as the wire was wound on when hot and therefore grips tightly in the screw-threads.

(4) *A longitudinal displacement of the magnet from the centre of the tube.*

The field at any point along the axis of a helix can be shown to be given by the formula

$$H = 2\pi nC \left[\left(1 + \frac{a^2}{l^2}\right)^{-\frac{1}{2}} + \left(1 + \frac{a^2}{l_1^2}\right)^{-\frac{1}{2}} \right]$$

where a is the radius of the helix, and l and l_1 are the distances of the point from the ends of the helix.

At the centre of the helix used this reduces to

$$\begin{aligned} H &= 4\pi nC \left[\left\{ 1 + \left(\frac{3 \cdot 13}{59}\right)^2 \right\}^{-\frac{1}{2}} \right] \\ &= 4\pi nC (0.998592) \\ &= 4\pi nC (1 - 0.001408). \end{aligned}$$

Suppose the magnet to be displaced 3 cm. from its central position. Then

$$\begin{aligned} H &= 2\pi nC \left[\left\{ 1 + \left(\frac{3 \cdot 13}{56}\right)^2 \right\}^{-\frac{1}{2}} + \left\{ 1 + \left(\frac{3 \cdot 13}{62}\right)^2 \right\}^{-\frac{1}{2}} \right] \\ &= 4\pi nC (0.998585). \end{aligned}$$

Thus a displacement of 3 cm. causes an alteration of 7 parts in 10^6 . As the magnet can easily be placed in its correct position at the centre of the helix to .5 cm., we see that any error likely to arise from a displacement of the magnet from its central position is altogether negligible, and a displacement out of the axis must give still less variation.

(5) *A residual torsion in the fibre.*

At first sight it might seem that a slight residual torsion in the fibre would be of no effect as the torsion is the same in both parts of the experiment. A little consideration shows, however, that this is not the case. If the torsion in the fibre be such that when the magnet is parallel to the earth's field there are θ degrees of twist in the fibre, then the magnet will come to rest making an angle α with the earth's field, where

$$2lH \sin \alpha = n(\theta - \alpha) \dots \dots \dots (A)$$

n being the force produced by one degree of torsion.

The helix is placed in such a position that on sending a current through it no alteration in the zero position of the

magnet takes place, *i. e.*, it is placed making an angle α with the earth's field.

Consider now what it is that we actually measure in the second part of the experiment. The magnet vibrates under a resultant field of $H \cos \alpha$ in both parts of the experiment. Let Z be the field actually produced by the helix.

α is the angle between the zero position of the magnet and the earth's field, but the coil is placed so that its field does not disturb the zero position of the magnet. The angle between the direction of H and the magnetic axis of the tube is therefore α .

Suppose the magnet reversed and the extra torsion taken out of the fibre. It comes to rest under the forces due to the earth's field, the field of the solenoid, and the torsion of the fibre. Let β be the angle between this zero position of the magnet and the magnetic axis of the solenoid.

The resultant field giving the same time of swing as in the first part of the experiment = $H \cos \alpha$.

Therefore we get

$$H \cos \alpha = Z \cos \beta - H \cos (\alpha + \beta). \quad \dots \quad (B)$$

Also the sum of the moments of the forces acting on the magnet at the centre of the magnet when it is in its zero position is zero. Hence we get

$$n(\theta - \alpha - \beta) + 2Hl \sin (\alpha + \beta) = 2Zl \sin \beta \quad \dots \quad (C)$$

where $2l$ is the length of the magnet.

Angles α and β are small and we may substitute the angles for the sines.

Eliminating n and β from equations A, B, and C we get the equation

$$Z \cos \frac{2\alpha(\theta - \alpha)}{\theta} = H \cos \alpha + H \cos \frac{3\alpha\theta - 2\alpha^2}{\theta},$$

which to a first approximation gives

$$\begin{aligned} Z &= \frac{H \cos \alpha + H \cos 3\alpha}{\cos 2\alpha} \\ &= 2H \cos \alpha. \end{aligned}$$

Hence, instead of measuring H we are measuring something very nearly $H \cos \alpha$.

Cosine α must therefore be 1 within the limits of accuracy of determination of the other quantities. As described previously, the torsion was eliminated as far as possible by allowing the system to come to rest before inserting the

magnet. It is difficult, however, to get rid of the last few degrees of torsion, and it was thought that these few degrees might have an appreciable influence. The magnitude of the influence was determined by experiment. 360° of torsion were put in the fibre and the consequent alteration of the equilibrium position of the magnet noted. Upon calculation it was found that 360° of torsion rotated the magnet through an angle α where $\sin \alpha = \cdot 00156$.

There would certainly be not more than 20° of torsion left in the fibre, and we get the maximum angle of deflexion owing to residual torsion to be $\sin^{-1} \frac{1}{10,000}$ approx. or

$$\begin{aligned} \text{cosine } \alpha &= \cdot 999999995 \\ &= 1 - 5 \times 10^{-9}. \end{aligned}$$

By neglecting α we may therefore introduce an error of 5 parts in 10^9 , which is altogether negligible. That the angle was inappreciable was shown by the fact that on reversing the magnet the zero position was indistinguishable from the zero position when under the earth's field alone. As will be seen from the above the angle between the two zero positions is β where

$$\beta = \frac{2H(\theta - \alpha)\alpha}{Z(\theta - \alpha) - H(\theta - 2\alpha)}.$$

Putting $Z = 2H$ and neglecting α^2 , we get $\beta = 2\alpha$.

As β could not be measured and the arrangement was such that an angle $\sin^{-1} \frac{1}{1000}$ could be determined, we see that α can be neglected.

(6) *Inaccurate timing of the period of oscillation.*

The timing of the oscillations is the chief limiting factor to the accuracy with which the determination can be made. Owing to the shortness of the silk fibre, the magnet system tends to come to rest comparatively quickly. Because of this the area of the mirror surface must be as small as possible in order to minimise the damping effect, and the magnet must be as strong and powerful as is consistent with the strength of the finest silk fibre.

Taking these precautions, the system can be made to oscillate for 15 minutes, which permits of an accuracy of 1 in 10,000 being made in the determination of the period of vibration.

A silk fibre is surprisingly strong, and several pieces of

magnetized clock-spring can be placed in the holder. This both lengthens the time during which it will oscillate and diminishes the angle " α " discussed in the last section.

The eye-and-ear method was of course adopted in the actual experiment.

In making another apparatus it would be better to use a wider tube and so permit the lengthening of the silk fibre.

The increased accuracy with which the oscillation period could be found would more than compensate for the increased importance of the factor $\cos \alpha$ in the formula

$$H = 4\pi nC \cos \alpha.$$

Lengthening the tube would be no disadvantage if the apparatus were to be fixed permanently in one place, and this would permit of an increased width without affecting the factor $\cos \alpha$.

(7) *Uncertainty in the determination of the current.*

The accuracy with which the current can be determined is limited by the accuracy with which the E.M.F. of the standard cadmium cell is known. The cell used was tested at the National Physical Laboratory after the experiment was first performed, and the result showed that its E.M.F. instead of being 1.01987 volt at 15° C., which was the value obtained from the certificate, was 1.01880 volt.

Cadmium cells show a gradual fall of E.M.F. with time and anomalous changes of E.M.F. with changes of temperature. It is unsafe to rely on their accuracy to more than 1 part in 10,000. This part of the experiment together with the timing of the oscillation limits the accuracy to 1 in 10,000.

If it were found necessary the current could be determined more accurately, but while the accuracy of determination of the oscillation period is so limited there is no point in insisting on a greater degree of accuracy in the knowledge of the magnitude of the current.

(8) *An error in the determination of the number of turns per cm.*

The method of determining the number of turns per cm. has been described already. The method consists of measuring the distance between two points enclosing a definite number of threads. No error at all can creep in through the determination of the number of threads, but the distance is only measured to within .005 mm. The total distance is 26 cm.,

and hence we have a possibility of error of 1 part in 50,000. This, being more accurate than the determination of the other quantities, can be neglected.

(9) *Heating of the coil.*

The heating of the coil may affect the results in two ways.

(a) An alteration in resistance of the coil wire, causing a corresponding variation in the current flowing through it, and therefore of the field produced by the current.

(b) An alteration in moment of the suspended magnet due to temperature variation.

(a) It is clear that if the experiment is to be accurate, the field produced by the current must be constant to within the limits of accuracy of the other determinations. The field, and consequently the current, must therefore be constant to at least 1 part in 10,000. The total resistance in the helix circuit is about 145 ohms, and the resistance of the helix is approximately 47 ohms. The variation must therefore be less than $\cdot 0145$ ohm; and as a change in temperature of 1 degree causes a variation of resistance of the helix of $\cdot 172$ ohm, we see that the maximum change of temperature allowable is approximately $\frac{1}{12}$ of a degree. The temperature change of the coil is therefore a serious item, and, unless the experiment is performed where there are no sudden temperature changes, likely to vitiate the results. Being embedded in shellac the helix is shielded from sudden temperature variations of the room, and the only factor likely to cause trouble is the heating of the helix due to the passage of the current. However, a thermometer graduated in tenths of a degree showed no change whatever during the experiment. As the thermometer could be read to $\frac{1}{20}$ of a degree, we see that the temperature change does not alter the current to an appreciable extent. The thermometer, however, follows the temperature of the shellac coating which may lag behind the wire a little, so that it is important to calculate roughly the temperature change likely to occur.

The current is approximately $\cdot 014$ ampere and the resistance 47 ohms, hence the heat developed per second is $\cdot 0092$ calory. This gives 31.12 calories per hour.

The mass of the wire of the helix is 538 grms., and as the specific heat of copper is $\cdot 092$, we see that 49.5 calories are needed to heat the helix 1 degree centigrade, assuming that no heat is lost by radiation. Thus in one hour, if no heat were lost by radiation, the temperature of the coil would rise $\cdot 63$ degree. The current is only passing for about

35 minutes, and during this time most of the heat generated, *i. e.* about 18 calories, will be dissipated. It is not likely, therefore, that the temperature would rise $\frac{1}{2}^{\circ}$ C. This heat generation by the passing of the current could be made of still less importance by increasing the external resistance and the E.M.F. of the battery sending the current. Thus by using a battery of 24 volts, and consequently an external resistance of about 1700 ohms, a resistance change of not greater than .17 ohm could be allowed. This admits of a rise in temperature of the coil of 1 degree, and as the maximum possible rise, excluding all radiation loss, is, during the 35 minutes during which the current passes, only $.37^{\circ}$ C., we see that the temperature rise would certainly be entirely negligible. That it did not introduce an error in the experiment as it was carried out was confirmed by the fact that a determination of the current after, as well as before, the timing of the oscillations showed no measurable variation in the current.

(b) The temperature coefficient of alteration of moment of a magnet is about 10^{-4} , and as the change of temperature was less than 1° C., its effect may be neglected.

From the foregoing discussions we see that the most important factor is the timing of the oscillations of the magnet, for all the other factors can, by suitable methods, be made negligible compared with this one.

Consequently, any improvement of apparatus which increases the period during which the magnet will vibrate, is of great value.

ACTUAL DETERMINATIONS OF "H."

For the actual experiment the apparatus was arranged as shown in figs. 2 and 3, the solenoid in fig. 2 being supported as shown in 2. The optical system for timing the vibrations is not shown in the figures, but was simple. The order of performing the experiment was as follows:—

The silk fibre was rid of torsion as previously described, and, after inserting the magnet in its holder, the apparatus supporting the magnet was placed inside the solenoid, so that the magnet was as near as possible to the centre. When the solenoid had been adjusted approximately parallel to the earth's field, the optical system was arranged so as to give an image of the Nernst lamp filament coincident with the intersection of the cross-wires of the telescope. The final adjustment of the position of the helix was then made as previously described. The period of vibration of the magnet under the influence of the earth's field was then determined

by the eye-and-ear method. A rough calculation showed that a current of approximately $\cdot 015$ ampere would be required to give a field of $2H$, assuming H to be $\cdot 18$.

A small piece of steel was held so as to attract the north pole of the magnet to the right, and the current was switched on, the direction of the current being such as to give a field directly opposite to that of the earth. The magnet was attracted to one side a little before switching on the current, in order to ensure a knowledge of which direction the magnet turned round. The magnet might have turned round either way had it been in its normal position, when the current was switched on, and it would have been impossible to tell which way to turn the suspension-head in order to correct for increased torsion. The pulley-wheel was then rotated through 180° in the direction in which the magnet had turned.

The period of oscillation of the magnet in its new field was now determined by noting the time for 100 swings. The period was shorter than that under the earth's field, but after one or two trials the current was adjusted to give approximately the same field as the earth's. The time of swing was now found by the eye-and-ear method. The period as found by this latter method being a little too long, the resistance in the circuit was very slightly diminished, and another determination of the time of oscillation made. Immediately after each determination of the period of vibration, the strength of the current in the solenoid was determined as previously described, and the thermometers were read. These latter showed no variation throughout the experiment.

The experiment was performed at Sheffield, and, owing to the trams passing in the neighbourhood of the laboratory where the observations were made, an accurate determination of the period of oscillation could not be made in the day-time. Each time a tram passed the building the magnet gave an easily perceptible jerk, and, as the passage of cars was frequent, any results obtained in the daytime were altogether vitiated.

Two experiments were carried out in the night-time, one from 12.45 A.M. to 2 A.M. on the morning of January 11th, 1913, and the other during the same hours on April 9th, 1913. The results of these experiments are given below. No temperature changes of the cadmium cell, standard resistance, or solenoid were observable during each experiment. All the adjustments were made beforehand, and only the actual timing of the oscillations and measurements of the currents needed to be performed during the night.

DATA FOR CALCULATION OF H.

Time 12.45 A.M.-2 A.M. January 11th, 1913.

Time of swing of magnet under influence of earth's field alone = *2.7577 seconds.*

Time of swing when magnet vibrates under influence of earth's field and field of solenoid = *2.7632 seconds.*

E.M.F. of Cadmium cell corrected for temperature = *1.01875 volts.*

Resistance of Standard similarly corrected = *9.9992 ohms.*

Current to produce the above field = *.014423 ampere.*

The time of swing is given by the formula

$$t = 2\pi\sqrt{\frac{1}{MH}},$$

or $t^2H = \text{constant.}$

Suppose C = current required to give field exactly equal to H.

Then $t^2C = K$, where K is constant. When vibrating under combined fields we have

$$t_1^2 (H_1 - H) = \text{constant,}$$

or $t_1^2 (C_1 - C) = K,$

$$\therefore t_1^2 (C_1 - C) = t^2 C;$$

and as we wish to find C we get

$$C = \frac{t_1^2}{t_1^2 + t^2} C_1.$$

Substituting in this equation the values found, viz. $t = 2.7577$, $t_1 = 2.7632$, and $C_1 = .014423$,

we get $2C = .014452,$

$$C = .007226.$$

The number of turns per cm. is *18.8739*

and cosine $\alpha = .99883.$

Substituting these values in the formula

$$H = .4\pi nC \cos \alpha,$$

we find that $H = .17186.$

Three observations of the period of swing under different

fields, two slightly larger than, and one slightly smaller than the earth's field, were made, one of which is detailed above. The results of the other two calculated exactly as above were as follows:—

$$\begin{aligned} \text{Time of swing } t_1 &= 2.7513 \text{ seconds} \\ \text{Current giving this} &= .014492 \text{ ampere} \\ H &= .17193. \end{aligned}$$

$$\begin{aligned} \text{Time of swing } t_1 &= 2.7597 \text{ seconds} \\ \text{Current to produce this} &= .014416 \text{ ampere} \\ H &= .17185. \end{aligned}$$

Taking the mean of these three values we get

$$H = \underline{\underline{.17188.}}$$

Time of second experiment was

1.15 A.M.—2.45 A.M. *April 9th, 1913.*

The magnet used in this experiment was stronger than the one used in the last, and the timing of the oscillations consequently more reliable.

$$\text{Time of swing in earth's field} = 2.5026 \text{ seconds.}$$

$$\begin{aligned} \text{Time of swing } t_1 &= 2.4912 \text{ seconds} \\ \text{Current required to produce this} &= .014541 \text{ ampere} \\ H &= .17214. \end{aligned}$$

$$\begin{aligned} \text{Time of swing } t_1 &= 2.5010 \text{ seconds} \\ \text{Current required to give this} &= .0144852 \text{ ampere} \\ H &= .17209. \end{aligned}$$

$$\begin{aligned} \text{Time of swing } t_1 &= 2.5055 \text{ seconds} \\ \text{Current required to give this} &= .014459 \text{ ampere} \\ H &= .17216. \end{aligned}$$

Giving on the average

$$H = \underline{\underline{.17213.}}$$

As a check on the values obtained "H" was determined by the Kew magnetometer in the same room and at about the same time of the night. An experienced observer, Mr. Southern, performed this latter experiment, and he obtained the value $H = .1726$. His work was carried out about the end of January, so that coincidence of results could not be expected. Apart from the possible actual alteration in H

during the periods elapsing between the carrying out of the three experiments, it is doubtful whether the magnetometer method can be relied on to the fourth figure.

The solenoid method seems to be reliable, accurate, and easily carried out. Although the preliminary parts of the above investigation were rather lengthy, little difficulty was experienced once the actual form of the different parts of the apparatus had been decided upon. In any future experiments with the same apparatus none of the preliminary experiments will have to be performed, and the whole of the observations could be made within one hour.

If the apparatus were fitted up in a permanent magnetic laboratory the helix might be made of considerable size, or even replaced by a prolate spheroid with windings at equal latitude distances. This would eliminate the difficulty of obtaining a very accurate value for the period of oscillation, as the suspension fibre could be made longer in a larger apparatus.

The instrument can be adapted to measure declination, and has been successfully used for that purpose, but the method was rather laborious.

In conclusion I wish to thank Mr. Southern for his check experiment with the Kew magnetometer, and to express my great indebtedness to Dr. Hicks—to whose suggestion the experiment was due—for his many valuable suggestions and kind interest in the work.

Cavendish Laboratory, Cambridge,
May 23, 1913.

LXIV. *Note on the Velocity of δ Rays.*
By NORMAN CAMPBELL, *Sc.D.**

IN a recent paper (Phil. Mag. June 1913, p. 804) an attempt was made to explain on the basis of J. J. Thomson's theory of ionization by charged particles the observed distribution of velocities among δ rays from metals. It was shown that that theory predicted that the distribution should be independent of the nature of the primary rays, but that it gave too small a value for the number of very slow δ rays (under 20 volts). This discrepancy is removed by the recent work of Bumstead (Phil. Mag. Aug. 1913,

* Communicated by the Author.

p. 233), which proves conclusively that most of these slow δ rays are liberated, not by the primary ionizing rays, but by the fast δ rays excited by those rays. The velocity of the δ rays should be independent of that of the exciting rays only so long as the latter is large compared with the energy required for ionization; this condition is not fulfilled when the δ rays are liberated by other δ rays; the proportion of δ rays with very small velocities should be greater than it would be if they were all produced by very fast ionizing rays.

Further, Bumstead shows that the number of fast δ rays (velocity greater than 40 volts) liberated with a velocity of W volts is approximately proportional to $1/W^{0.75}$. According to the theory given it should be proportional to $\frac{W_0}{W + W_0}$, where W_0 is the energy required for ionization. But it must be remembered that the number of such δ rays observed is less than that liberated, because some of the rays spend their energy in producing other slower δ rays, and disappear from the beam. So long as W is greater than 200 volts, the ionizing power of an electron of speed W is nearly proportional to $1/W$; hence we should expect the number of fast rays in the emergent beam to be approximately proportional to $\frac{W_0}{W + W_0} \left(1 - \frac{a}{W}\right)$, where a is a constant. If this expression is to be represented by a formula b/W^n , n must be somewhat less than 1 in accordance with Bumstead's measurements.

An accurate deduction of the distribution of the emergent velocities of the emergent δ rays, taking into account the emission of secondary β rays and the effect of that emission on the primary β rays, involves so many assumptions concerning which there is no experimental knowledge, that it does not appear to be worth while to enter on the necessary complexities. There appears to be nothing in our present knowledge of the δ rays which is inconsistent with the view that they represent the electrons ejected from atoms by the passage through them of charged particles in accordance with the simple theory of that action given by Thomson.

Leeds University,
August 1913.

LXV. *On the Motion of a Viscous Fluid.*

By Lord RAYLEIGH, O.M., F.R.S.*

IT has been proved by Helmholtz † and Korteweg ‡ that when the velocities at the boundary are given, the slow steady motion of an incompressible viscous liquid satisfies the condition of making F , the dissipation, an absolute minimum. If u_0, v_0, w_0 be the velocities in one motion M_0 , and u, v, w those of another motion M satisfying the same boundary conditions, the difference of the two u', v', w' , where

$$u' = u - u_0, \quad v' = v - v_0, \quad w' = w - w_0, \quad . \quad . \quad (1)$$

will constitute a motion M' such that the boundary velocities vanish. If F_0, F, F' denote the dissipation-functions for the three motions M_0, M, M' respectively, all being of necessity positive, it is shown that

$$F = F_0 + F' - 2\mu \int (u' \nabla^2 u_0 + v' \nabla^2 v_0 + w' \nabla^2 w_0) dx dy dz, \quad . \quad (2)$$

the integration being over the whole volume. Also

$$\begin{aligned} F' &= -\mu \int (u' \nabla^2 u' + v' \nabla^2 v' + w' \nabla^2 w') dx dy dz \\ &= \mu \int \left[\left(\frac{dw'}{dy} - \frac{dv'}{dz} \right)^2 + \left(\frac{du'}{dz} - \frac{dw'}{dx} \right)^2 \right. \\ &\quad \left. + \left(\frac{dv'}{dx} - \frac{du'}{dy} \right)^2 \right] dx dy dz. \quad . \quad . \quad . \quad (3) \end{aligned}$$

These equations are purely kinematical, if we include under that head the incompressibility of the fluid. In the application of them by Helmholtz and Korteweg the motion M_0 is supposed to be that which would be steady if small enough to allow the neglect of the terms involving the second powers of the velocities in the dynamical equations. We then have

$$\mu \nabla^2 (u_0, v_0, w_0) = \left(\frac{d}{dx}, \frac{d}{dy}, \frac{d}{dz} \right) (\nabla \rho + p_0), \quad . \quad (4)$$

where V is the potential of impressed forces. In virtue of (4)

$$\int (u' \nabla^2 u_0 + v' \nabla^2 v_0 + w' \nabla^2 w_0) dx dy dz = 0, \quad . \quad (5)$$

* Communicated by the Author.

† 'Collected Works,' vol. i. p. 223 (1869).

‡ Phil. Mag. vol. xvi. p. 112 (1883).

if the space occupied by the fluid is simply connected, or in any case if V be single-valued. Hence

$$F = F_0 + F', \dots \dots \dots (6)$$

or since F' is necessarily positive, the motion M_0 makes F an absolute minimum. It should be remarked that F' can vanish only for a motion such as can be assumed by a solid body (Stokes), and that such a motion could not make the boundary velocities vanish. The motion M_0 determined by (4) is thus unique.

The conclusion expressed in (6) that M_0 makes F an absolute minimum is not limited to the supposition of a slow motion. All that is required to ensure the fulfilment of (5), on which (6) depends, is that $\nabla^2 u_0, \nabla^2 v_0, \nabla^2 w_0$ should be the derivatives of some single-valued function. Obviously it would suffice that $\nabla^2 u_0, \nabla^2 v_0, \nabla^2 w_0$ vanish, as will happen if the motion have a velocity-potential. Stokes* remarked long ago that when there is a velocity-potential, not only are the ordinary equations of fluid motion satisfied, but the equations obtained when friction is taken into account are satisfied likewise. A motion with a velocity-potential can always be found which shall have prescribed *normal* velocities at the boundary, and the tangential velocities are thereby determined. If these agree with the prescribed tangential velocities of a viscous fluid, all the conditions are satisfied by the motion in question. And since this motion makes F an absolute minimum, it cannot differ from the motion determined by (4) with the same boundary conditions. We may arrive at the same conclusion by considering the general equation of motion—

$$\rho \left(\frac{du}{dt} + u \frac{du}{dx} + v \frac{du}{dy} + w \frac{du}{dz} \right) = \mu \nabla^2 u - \frac{d(\rho V + p)}{dx}. \quad (7)$$

If there be a velocity-potential ϕ , so that $u = d\phi/dx$, &c.,

$$u \frac{du}{dx} + v \frac{du}{dy} + w \frac{du}{dz} = \frac{1}{2} \frac{d}{dx} \left\{ \left(\frac{d\phi}{dx} \right)^2 + \left(\frac{d\phi}{dy} \right)^2 + \left(\frac{d\phi}{dz} \right)^2 \right\}; \quad (8)$$

and then (7) and its analogues reduce practically to the form (4) if the motion be steady.

Other cases where F is an absolute minimum are worthy

* Camb. Trans. vol. ix. (1850); 'Math. and Phys. Papers,' vol. iii. p. 73

of notice. It suffices that

$$\nabla^2 u_0 = \frac{dH}{dx}, \quad \nabla^2 v_0 = \frac{dH}{dy}, \quad \nabla^2 w_0 = \frac{dH}{dz}, \quad . \quad (9)$$

where H is a single-valued function, subject to $\nabla^2 H = 0$. If ξ_0, η_0, ζ_0 be the rotations,

$$2\nabla^2 \xi_0 = \nabla^2 \left(\frac{dw_0}{dy} - \frac{dv_0}{dz} \right) = \frac{d}{dy} \nabla^2 w_0 - \frac{d}{dz} \nabla^2 v_0 = 0;$$

and thus (9) requires that

$$\nabla^2 \xi_0 = 0, \quad \nabla^2 \eta_0 = 0, \quad \nabla^2 \zeta_0 = 0. \quad . \quad . \quad (10)$$

In two dimensions the dynamical equation reduces to $D\xi_0/Dt = 0^*$, so that ξ_0 is constant along a stream-line. Among the cases included are the motion between two planes

$$u_0 = A + By + Cy^2, \quad v_0 = 0, \quad w_0 = 0, \quad . \quad . \quad (11)$$

and the motion in circles between two coaxial cylinders ($\xi_0 = \text{constant}$). Also, without regard to the form of the boundary, the uniform rotation, as of a solid body, expressed by

$$u_0 = Cy, \quad v_0 = -Cx. \quad . \quad . \quad . \quad (12)$$

In all these cases F is an absolute minimum.

Conversely, if the conditions (9) be not satisfied, it will be possible to find a motion for which $F < F_0$. To see this choose a place as origin of coordinates where $d\nabla^2 u_0/dy$ is not equal to $d\nabla^2 v_0/dx$. Within a small sphere described round this point as centre let $u' = Cy, v' = -Cx, w' = 0$, and let $u' = 0, v' = 0, w' = 0$ outside the sphere, thus satisfying the prescribed boundary conditions. Then in (2)

$$\begin{aligned} & \int (u' \nabla^2 u_0 + v' \nabla^2 v_0 + w' \nabla^2 w_0) dx dy dz \\ & = C \int (y \nabla^2 u_0 - x \nabla^2 v_0) dx dy dz, \quad . \quad . \quad (13) \end{aligned}$$

the integration being over the sphere. Within this small region we may take

$$\begin{aligned} \nabla^2 u_0 &= (\nabla^2 u_0)_0 + \frac{d\nabla^2 u_0}{dx_0} x + \frac{d\nabla^2 u_0}{dy_0} y + \frac{d\nabla^2 u_0}{dz_0} z, \\ \nabla^2 v_0 &= (\nabla^2 v_0)_0 + \frac{d\nabla^2 v_0}{dx_0} x + \frac{d\nabla^2 v_0}{dy_0} y + \frac{d\nabla^2 v_0}{dz_0} z; \end{aligned}$$

* Where $D/Dt = d/dt + u d/dx + v d/dy + w d/dz$.

so that (13) reduces to

$$C \left(\frac{d\nabla^2 u_0}{dy_0} - \frac{d\nabla^2 v_0}{dx_0} \right) \int (y^2 \text{ or } x^2) dx dy dz.$$

Since the sign of C is at disposal, this may be made positive or negative at pleasure. Also F' in (2) may be neglected as of the second order when u', v', w' are small enough. It follows that F is not an absolute minimum for u_0, v_0, w_0 , unless the conditions (9) are satisfied.

Korteweg has also shown that the slow motion of a viscous fluid denoted by M_0 is *stable*. "When in a given region occupied by viscous incompressible fluid there exists at a certain moment a mode of motion M which does not satisfy equation (4), then, the velocities along the boundary being maintained constant, the change which must occur in the mode of motion will be such (neglecting squares and products of velocities) that the dissipation of energy by internal friction is constantly decreasing till it reaches the value F_0 and the mode of motion becomes identical with M_0 ."

This theorem admits of instantaneous proof. If the terms of the second order are omitted, the equations of motion, such as (7), are linear, and any two solutions may be superposed. Consider two solutions, both giving the same velocities at the boundary. Then the difference of these is also a solution representing a possible motion with zero velocities at the boundary. But such a motion necessarily comes to rest. Hence with flux of time the two original motions tend to become and to remain identical. If one of these is the steady motion, the other must tend to become coincident with it.

The stability of the *slow* steady motion of a viscous fluid, or (as we may also put it) the steady motion of a *very* viscous fluid, is thus ensured. When the circumstances are such that the terms of the second order must be retained, there is but little definite knowledge as to the character of the motion in respect of stability. Viscous fluid, contained in a vessel which rotates with uniform velocity, would be expected to acquire the same rotation and ultimately to revolve as a solid body, but the expectation is perhaps founded rather upon observation than upon theory. We might, however, argue that any other event would involve perpetual dissipation which could only be met by a driving force applied to the vessel, since the kinetic energy of the motion could not for ever diminish. And such a maintained driving couple would generate angular momentum without

limit—a conclusion which could not be admitted. But it may be worth while to examine this case more closely.

We suppose as before that u_0, v_0, w_0 are the velocities in the steady motion M_0 and u, v, w those of the motion M , both motions satisfying the dynamical equations, and giving the prescribed boundary velocities; and we consider the expression for the kinetic energy T' of the motion (1) which is the difference of these two, and so makes the velocities vanish at the boundary. The motion M' with velocities u', v', w' does not in general satisfy the dynamical equations. We have

$$\frac{1}{\rho} \frac{dT'}{dt} = \int \left\{ u' \frac{du'}{dt} + v' \frac{dv'}{dt} + w' \frac{dw'}{dt} \right\} dx dy dz. \quad (14)$$

In equations (7) which are satisfied by the motion M we substitute $u = u_0 + u'$, &c.; and since the solution M_0 is steady we have

$$\frac{du_0}{dt} = \frac{dv_0}{dt} = \frac{dw_0}{dt} = 0. \quad \dots \quad (15)$$

We further suppose that $\nabla^2 u_0, \nabla^2 v_0, \nabla^2 w_0$, are derivatives of a function H , as in (9). This includes the case of uniform rotation expressed by

$$u_0 = y, \quad v_0 = -x, \quad w_0 = 0, \quad \dots \quad (16)$$

as well as those where there is a velocity-potential. Thus (7) becomes

$$\begin{aligned} \frac{du'}{dt} = & \nu \nabla^2 u' - \frac{d\varpi}{dx} - (u_0 + u') \left(\frac{du_0}{dx} + \frac{du'}{dx} \right) \\ & - (v_0 + v') \left(\frac{du_0}{dy} + \frac{du'}{dy} \right) - (w_0 + w') \left(\frac{du_0}{dz} + \frac{du'}{dz} \right), \end{aligned} \quad (17)$$

with two analogous equations, where

$$\varpi = V + p/\rho - \nu H, \quad \nu = \mu/\rho. \quad \dots \quad (18)$$

These values of du'/dt , &c., are to be substituted in (14).

In virtue of the equation of continuity to which u', v', w' are subject, the terms in ϖ contribute nothing to dT'/dt , as appears at once on integration by parts. The remaining terms in dT'/dt are of the first, second, and third degree in u', v', w' . Those of the first degree contribute nothing, since u_0, v_0, w_0 satisfy equations such as

$$u_0 \frac{du_0}{dx} + v_0 \frac{du_0}{dy} + w_0 \frac{du_0}{dz} = - \frac{d\varpi_0}{dx} \quad \dots \quad (19)$$

The terms of the third degree are

$$\begin{aligned}
 & - \int \left[u' \left\{ u' \frac{du'}{dx} + v' \frac{du'}{dy} + w' \frac{du'}{dz} \right\} \right. \\
 & \quad + v' \left\{ u' \frac{dv'}{dx} + v' \frac{dv'}{dy} + w' \frac{dv'}{dz} \right\} \\
 & \quad \left. + w' \left\{ u' \frac{dw'}{dx} + v' \frac{dw'}{dy} + w' \frac{dw'}{dz} \right\} \right] dx dy dz,
 \end{aligned}$$

which may be written

$$\begin{aligned}
 & - \frac{1}{2} \int \left[u' \frac{d(u'^2 + v'^2 + w'^2)}{dx} + v' \frac{d(u'^2 + v'^2 + w'^2)}{dy} \right. \\
 & \quad \left. + w' \frac{d(u'^2 + v'^2 + w'^2)}{dz} \right] dx dy dz;
 \end{aligned}$$

and this vanishes for the same reason as the terms in ω .

We are left with the terms of the second degree in u', v', w' . Of these the part involving ν is

$$\nu \int [u' \nabla^2 u' + v' \nabla^2 v' + w' \nabla^2 w'] dx dy dz. \quad (20)$$

So far as this part is concerned, we see from (3) that

$$dT'/dt = -F', \quad (21)$$

F' being the dissipation-function calculated from u', v', w' .

Of the remaining 18 terms of the second degree, 9 vanish as before when integrated, in virtue of the equation of continuity satisfied by u_0, v_0, w_0 . Finally we have *

$$\begin{aligned}
 \frac{dT'}{dt} = & -F' - \rho \int \left[u' \left\{ u' \frac{du_0}{dx} + v' \frac{du_0}{dy} + w' \frac{du_0}{dz} \right\} \right. \\
 & + v' \left\{ u' \frac{dv_0}{dx} + v' \frac{dv_0}{dy} + w' \frac{dv_0}{dz} \right\} \\
 & \left. + w' \left\{ u' \frac{dw_0}{dx} + v' \frac{dw_0}{dy} + w' \frac{dw_0}{dz} \right\} \right] dx dy dz. \quad (22)
 \end{aligned}$$

If the motion u_0, v_0, w_0 be in two dimensions, so that

* Compare O. Reynolds, Phil. Trans. 1895, Part I. p. 146. In Lorentz's deduction of a similar equation (*Abhandlungen*, vol. i. p. 46) the additional motion is assumed to be small. This memoir, as well as that of Orr referred to below, should be consulted by those interested. See also Lamb's *Hydrodynamics*, § 346.

$w_0=0$, while u_0 and v_0 are independent of z , (22) reduces to

$$\frac{dT'}{dt} = -F' - \rho \int \left[u'^2 \frac{du_0}{dx} + v'^2 \frac{dv_0}{dy} + u'v' \left(\frac{du_0}{dy} + \frac{dv_0}{dx} \right) \right] dx dy dz. \quad (23)$$

Under this head comes the case of uniform rotation expressed in (16), for which

$$\frac{du_0}{dx} = 0, \quad \frac{dv_0}{dy} = 0, \quad \frac{du_0}{dy} + \frac{dv_0}{dx} = 0.$$

Here then $dT'/dt = -F'$ simply, that is T' continually diminishes until it becomes insensible. Any motion superposed upon that of uniform rotation gradually dies out.

When the motion u_0, v_0, w_0 has a velocity-potential ϕ , (22) may be written

$$\begin{aligned} \frac{dT'}{dt} = -F' - \rho \int & \left[u'^2 \frac{d^2\phi}{dx^2} + v'^2 \frac{d^2\phi}{dy^2} + w'^2 \frac{d^2\phi}{dz^2} \right. \\ & \left. + 2u'v' \frac{d^2\phi}{dx dy} + 2v'w' \frac{d^2\phi}{dy dz} + 2w'u' \frac{d^2\phi}{dz dx} \right] dx dy dz. \quad (24) \end{aligned}$$

So far as I am aware, no case of complete stability for all values of μ is known, other than the motion possible to a solid body above considered. It may be doubted whether such cases exist. Under the head of (24) a simple example occurs when $\phi = \tan^{-1}(y/x)$, the irrotational motion taking place in concentric circles. Here if $r^2 = x^2 + y^2$,

$$\frac{dT'}{dt} = -F' - 2\rho \int \left[\frac{xy}{r^4} (u'^2 - v'^2) + \frac{y^2 - x^2}{r^4} u'v' \right] dx dy dz. \quad (25)$$

If the superposed motion also be two-dimensional, it may be expressed by means of a stream-function ψ . We have in terms of polar coordinates

$$\begin{aligned} u' &= \frac{d\psi}{dy} = \frac{d\psi}{dr} \sin \theta + \frac{1}{r} \frac{d\psi}{d\theta} \cos \theta, \\ -v' &= \frac{d\psi}{dx} = \frac{d\psi}{dr} \cos \theta - \frac{1}{r} \frac{d\psi}{d\theta} \sin \theta, \end{aligned}$$

so that

$$u'^2 - v'^2 = (\cos^2\theta - \sin^2\theta) \left\{ \frac{1}{r^2} \left(\frac{d\psi}{d\theta} \right)^2 - \left(\frac{d\psi}{dr} \right)^2 \right\} + \frac{4 \sin \theta \cos \theta}{r} \frac{d\psi}{dr} \frac{d\psi}{d\theta},$$

$$-u'v' = \cos \theta \sin \theta \left\{ \left(\frac{d\psi}{dr} \right)^2 - \frac{1}{r^2} \left(\frac{d\psi}{d\theta} \right)^2 \right\} + \frac{\cos^2\theta - \sin^2\theta}{r} \frac{d\psi}{dr} \frac{d\psi}{d\theta}.$$

Thus

$$\cos \theta \sin \theta (u'^2 - v'^2) - (\cos^2\theta - \sin^2\theta)u'v' = \frac{1}{r} \frac{d\psi}{dr} \frac{d\psi}{d\theta}, \quad \dots \quad (26)$$

and (25) becomes

$$\frac{dT'}{dt} = -F' - 2\rho \iiint \frac{1}{r^2} \frac{d\psi}{dr} \frac{d\psi}{d\theta} dr d\theta dz, \quad \dots \quad (27)$$

T' , F' , as well as the last integral, being proportional to z .

We suppose the motion to take place in the space between two coaxial cylinders which revolve with appropriate velocities. If the additional motion be also symmetrical about the axis, the stream-lines are circles, and ψ is a function of r only. The integral in (27) then disappears and dT'/dt reduces to $-F'$, so that under this restriction * the original motion is stable. The experiments of Couette † and of Mallock ‡, made with revolving cylinders, appear to show that when u' , v' , w' are not specially restricted the motion is unstable. It may be of interest to follow a little further the indications of (27).

The general value of ψ is

$$\psi = C_0 + C_1 \cos \theta + S_1 \sin \theta + \dots + C_n \cos n\theta + S_n \sin n\theta, \quad \dots \quad (28)$$

C_n , S_n being functions of r , whence

$$\int \frac{d\psi}{dr} \frac{d\psi}{d\theta} d\theta = \pi \sum n \left(S_n \frac{dC_n}{dr} - C_n \frac{dS_n}{dr} \right), \quad \dots \quad (29)$$

n being 1, 2, 3, &c. If S_n , C_n differ only by a constant

* We may imagine a number of thin, coaxial, freely rotating cylinders to be interposed between the extreme ones whose motion is prescribed.

† *Ann. d. Chimie*, t. xxi. p. 433 (1890).

‡ *Proc. Roy. Soc.* vol. lix. p. 38 (1895).

multiplier, (29) vanishes. This corresponds to

$$\psi = R_0 + R_1 \cos(\theta + \epsilon_1) + \dots + R_n \cos n(\theta + \epsilon_n) + \dots, \quad (30)$$

where $R_0, R_1, \&c.$ are functions of r , while $\epsilon_1, \epsilon_2, \&c.$ are constants. If ψ can be thus limited, dT'/dt reduces to $-F'$, and the original motion is stable.

In general

$$\frac{dT'}{dt} = -F' - 2\pi\rho z \int \sum n \left(S_n \frac{dC_n}{dr} - C_n \frac{dS_n}{dr} \right) \frac{dr}{r^2} \dots \quad (31)$$

C_n, S_n must be such as to give at the boundaries

$$C_n = 0, \quad dC_n/dr = 0, \quad S_n = 0, \quad dS_n/dr = 0; \dots \quad (32)$$

otherwise they are arbitrary functions of r . It may be noticed that the sign of any term in (29) may be altered at pleasure by interchange of C_n and S_n .

When μ is great, so that the influence of F preponderates, the motion is stable. On the other hand when μ is small, the motion is probably unstable, unless special restrictions can be imposed.

A similar treatment applies to the problem of the uniform shearing motion of a fluid between two parallel plane walls, defined by

$$u_0 = A + By, \quad v_0 = 0, \quad w_0 = 0. \quad \dots \quad (33)$$

From (23)

$$\frac{dT'}{dt} = -F' - \rho B \iint u' v' dx dy. \quad \dots \quad (34)$$

If in the superposed motion $v' = 0$, the double integral vanishes and the original motion is stable. More generally, if the stream-function of the superposed motion be

$$\psi = C \cos kx + S \sin kx, \quad \dots \quad (35)$$

where C, S are functions of y , we find

$$\begin{aligned} \frac{dT'}{dt} &= -F' + \rho B \iint \frac{d\psi}{dy} \frac{d\psi}{dx} dx dy \\ &= -F' + \frac{\rho B \cdot kx}{2} \int \left(S \frac{dC}{dy} - C \frac{dS}{dy} \right) dy. \quad \dots \quad (36) \end{aligned}$$

Here again if the motion can be such that C and S differ only by a constant multiplier, the integral would vanish.

When μ is small and there is no special limitation upon the disturbance, instability probably prevails. The question whether μ is to be considered great or small depends of course upon the other data of the problem. If D be the distance between the planes, we have to deal with BD^2/ν (Reynolds).

In an important paper * Orr, starting from equation (34), has shown that if BD^2/ν is less than 177 "every disturbance must automatically decrease, and that (for a higher value than 177) it is possible to prescribe a disturbance which will increase for a time." We must not infer that when $BD^2/\nu > 177$ the regular motion is necessarily unstable. As the fluid moves under the laws of dynamics, the initial increase of certain disturbances may after a time be exchanged for a decrease, and this decrease may be without limit.

At the other extreme when ν is very small, observation shows that the tangential traction on the walls, moving (say) with velocities $\pm U$, tends to a statistical uniformity and to become proportional, no longer to U , but to U^2 . If we assume this law to be absolute in the region of high velocity, the principle of dynamical similarity leads to rather remarkable conclusions. For the tangential traction, having the dimensions of a pressure, must in general be of the form

$$\rho U^2 \cdot f\left(\frac{\nu}{UD}\right), \quad \dots \dots (37)$$

D being the distance between the walls, and f an arbitrary function. In the regular motion (z large) $f(z) = 2z$, and (37) is proportional to U . If (37) is proportional to U^2 , f must be a constant and the traction becomes independent not only of μ , but also of D .

If the velocity be not quite so great as to reduce f to constancy, we may take

$$f(z) = a + bz,$$

where a and b are numerical constants, so that (37) becomes

$$a\rho U^2 + b\mu U/D. \quad \dots \dots (38)$$

It could not be assumed without further proof that b has the value (2) appropriate to a large z ; nevertheless,

* Proc. Roy. Irish Acad. 1907.

Korteweg's equation (6) suggests that such may be the case.

From data given by Couette I calculate that in C.G.S. measure

$$a = \cdot 000027.$$

The tangential traction is thus about a twenty thousandth part of the pressure ($\frac{1}{2}\rho U^2$) due to the normal impact of the fluid moving with velocity U .

Even in cases where the steady motion of a viscous fluid satisfying the dynamical equations is certainly unstable, there is a distinction to be attended to which is not without importance. It may be a question of the *time* during which the fluid remains in an unstable condition. When fluid moves between two coaxial cylinders, the instability has an indefinite time in which to develop itself. But it is otherwise in many important problems. Suppose that fluid has to move through a narrow place, being guided for example by hyperbolic surfaces, either in two dimensions, or in three with symmetry about an axis. If the walls have suitable tangential velocities, the motion may be irrotational. This irrotational motion is that which would be initiated from rest by propellent impulses acting at a distance. If the viscosity were great, the motion would be steady and stable; if the viscosity is less, it still satisfies the dynamical equations, but is (presumably) unstable. But the instability, as it affects any given portion of the fluid, has a very short duration. Only as it approaches the narrows has the fluid any considerable velocity, and as soon as the narrows are passed the velocity falls off again. Under these circumstances it would seem probable that the instability in the narrows would be of little consequence, and that the irrotational motion would practically hold its own. If this be so, the tangential movement of the walls exercises a profound influence, causing the fluid to follow the walls on the down-stream side, instead of shooting onwards as a jet—the behaviour usually observed when fluid is invited to follow fixed divergent walls, unless indeed the expansion is very gradual.

July 1913.

LXVI. *Note on Radiation and Specific Heat.*

By H. L. CALLENDAR*.

THE following note is communicated in explanation of some points raised in my address to Section A of the British Association last year.

When a given quantity of full radiation is compressed in a reflecting enclosure the wave-length of each component is altered by the Doppler effect in proportion to the cube root of the volume, and the intrinsic energy of each varies directly as the frequency. The measure of the temperature is the common ratio in which the energy and frequency of all the components is changed; and the measure of the quantity of each component which remains constant is the energy divided by the frequency, or in the case of full radiation by the temperature.

A quantity of radiation such that the product of its pressure and volume pv is equal to RT (the same as that of a gramme molecule of a gas at the same temperature) may conveniently be called a gramme-molecule, and regarded as consisting of N separate molecules (molecules of caloric) for descriptive purposes. If the frequencies of the components are included between the limits ν and $\nu + d\nu$ at the temperature T , the intrinsic energy E per gm. mol. may be represented by $Rb\nu$, where b is a constant, and will be included in an equal interval $d\nu/\nu$ of frequency when ν is varied by adiabatic compression in the same ratio as T , the quantity remaining constant. The ratio E/pv of the energy-density E/v to the pressure p , will be of the form $b\nu/T$, and the latent heat, $L = E/v + p$, absorbed in the production of unit volume will be represented by $p(1 + b\nu/T)$.

It is assumed on the molecular theory that the condition of equilibrium between different frequencies at the same temperature is the same as that between molecules, namely, that the product pv for N molecules of any frequency is equal to RT , in which case the expression $b\nu/T$ for the ratio E/pv applies generally when ν and T vary independently. The variation of the saturation pressure p of a particular frequency ν follows immediately by Carnot's principle, since the latent heat per unit volume $E/v + p$ must be equal to $T(dp/dT)$. The integration of this equation at constant ν gives an expression of the form,

$$p = C\nu^3 T e^{-b\nu/T}, \quad \dots \dots \dots (1)$$

in which the constant of integration $C\nu^3$, as a function of ν ,

* Communicated by the Author.

is determined by the condition that p must vary as ν^4 or T^4 when ν/T is constant, since full radiation remains saturated in adiabatic compression.

The corresponding expression for the intrinsic energy-density E/ν is

$$E/\nu = Cb\nu^4 e^{-b\nu/T}. \quad . \quad . \quad . \quad . \quad . \quad (2)$$

Expressions (1) and (2) apply to the variation of the pressure and energy-density of components or molecules included in a frequency interval $d\nu/\nu$, which remains constant when ν is varied. The quantity observed in experimental measurements is proportional to the latent heat per unit volume, which is the sum of (1) and (2). The isochromatics, or the curves representing the variation with temperature of the latent energy-density of a particular wave-length or frequency, are of the form,

$$E/\nu + p = C\nu^3(T + b\nu)e^{-b\nu/T}, \quad . \quad . \quad . \quad (3)$$

which agrees somewhat better than Planck's well-known formula with the observations of Rubens on the *Reststrahlen* of quartz, fluoride, and rocksalt.

The curve of variation of latent heat with frequency at constant temperature, or the distribution of energy in the spectrum, is most familiarly expressed in terms of the wave-length $\lambda = c/\nu$, where c is the velocity of light. The latent energy-density L per unit range of λ is given by the equation

$$Ld\lambda = Cc^3\lambda^{-5}(\lambda T + bc)e^{-bc/\lambda T}d\lambda. \quad . \quad . \quad (4)$$

This curve has a maximum when $\lambda T = \cdot 2071 bc$, whence the value of the constant bc is 1.400, if λ is measured in cms. and the position of the maximum is taken at $\lambda T = \cdot 2900$ from experimental data. Formula (4) reduces, like Planck's equation, to Rayleigh's formula for large values of λT , and to Wien's formula for small values. The relative values given by equation (4) for the distribution throughout the observational range on either side of the maximum, agree so closely with those given by Planck's formula that a special null method was devised with the object of testing the formulæ by experiment. Unfortunately, the somewhat elaborate apparatus required for this purpose, though commenced in 1908, has not yet been completed owing to pressure of other work. In the meantime the approximate agreement with Planck's formula may be taken as an indication of the possible correctness of (4), which appears to harmonize better than Planck's formula with the "classical thermodynamics."

If the values given in (1) and (2) for the partial pressure and energy-density in equal intervals $d\nu/\nu$ (or $d\lambda/\lambda$) are integrated from 0 to infinity at constant temperature, we obtain for the total pressure and energy-density of full radiation the expressions

$$P = 2CT^4/b^3, \text{ and } E/V = 6CT^4/b^3, \dots (5)$$

or the pressure of full radiation is one-third of the intrinsic energy-density, which is the relation generally assumed in deducing the fourth-power law, but this cannot be true for each component separately.

According to the theory of exchanges, the total stream $Q = \sigma T^4$, which issues per sq. cm. per sec. from a black surface at a temperature T , is $3c/4$ of the pressure, or $c/4$ of the energy-density, in the case of full radiation. Whence the value of the constant C is $2b^3\sigma/3c$, in terms of the radiation constant σ , the probable value of which is 5.60×10^{-5} C.G.S.

It will be observed that, in the case of long waves and high temperatures, according to formula (4), neglecting the square of the small quantity $bc/\lambda T$, the total energy reduces to the pressure term, namely, $Cc^3\lambda^{-4}T$. If the external energy pv is equally divided among the molecules as already assumed, the value of the constant Cc^3 should be $8\pi R/N$, according to the reasoning of Lord Rayleigh ('Nature,' vol. lxxii. p. 54) based on the equipartition of energy. The value of N deduced from that of C on this assumption is 6.12×10^{23} , which agrees closely with Planck's * value, and with the latest estimates based on the phenomena of radio-activity. But according to my view, equipartition applies only to the pressure-energy. The intrinsic energy, depending on the frequency, should not be equally divided, because the frequencies are mutually independent, and incapable of directly affecting each other in free æther. There is, however, an analogous relation for the partition of energy of a given frequency between the æther and a material molecule of the same frequency.

According to Planck's well-known relation, the intrinsic energy U_λ of a resonator of frequency c/λ in equilibrium

* It may be remarked that Planck's *quantum* h is the same as the molecular unit of caloric Rb/N , namely the intrinsic energy $Rb\nu$ per gm. mol. divided by the number of molecules N and by the frequency ν . The difference between the present theory and Planck's appears to originate mainly from his assumption for the entropy relation, $TdS = dE$, in place of the usual $dE + pdv$.

with full radiation of intrinsic energy-density u_λ per unit range of λ at λ , is given by the equation

$$U_\lambda = 3\lambda^4 u_\lambda / 8\pi; \quad (6)$$

this appears to be deducible from the usual differential equation of forced oscillations on the assumption that the only damping is that due to radiation, and may be applied with a fair degree of probability to the equilibrium between the intrinsic energy of vibration of molecules and that of the corresponding frequencies of thermal radiation.

Taking the value of u_λ as that given by the intrinsic energy term in equation (4), with $8\pi R/N$ for Ce^3 , the intrinsic energy of N molecules in equilibrium with full radiation at a temperature T becomes

$$E = NU_\lambda = 3R e^{-bc/\lambda T} bc/\lambda, \quad (7)$$

the limit of which, when T is infinite, is $3Rb\nu$, or three times the intrinsic energy of a gramme molecule of radiation of the same frequency. This quantity may be regarded simply as the intrinsic energy of the radiation condensed in the molecules, which is independent of the temperature except for the exponential term.

The corresponding value of the PV of the condensed radiation is,

$$PV = 3RT e^{-bc/\lambda T}. \quad (8)$$

The only specific heat which can be measured experimentally in the majority of cases is the rate of variation of the total heat $E + PV$ when the substance is in equilibrium with full radiation. The term PV here represents the internal pressure-energy of the condensed radiation. The external pressure may generally be neglected in the case of solids or liquids in comparison with the internal pressure of the radiation.

Differentiating the sum of (7) and (8) with regard to T , and writing z as an abbreviation for $bc/\lambda T$ or $b\nu/T$, we obtain as the expression for the variation of the specific heat in the simple case of a gramme-atom of a substance possessing only a single frequency,

$$d(E + PV)/dT = 3R(1 + z + z^2)e^{-z}. \quad . . . (9)$$

This expression gives a limit $3R$, as it should, when $z=0$, but has a maximum $9R/e$, when $z=1$. This might appear at first sight to be a fatal objection, but it is a well ascertained fact, which has not been previously explained in a satisfactory manner, that some simple substances, such as

water and mercury, show a diminution of specific heat with rise of temperature.

If the mean frequencies given by the Reststrahlen for rock-salt and sylvine are inserted in this formula, the values obtained for the specific heats are in good agreement with those found experimentally at the temperature of liquid air, but are somewhat lower than those found in liquid hydrogen, and slightly higher than those found at ordinary temperatures. This may be explained by supposing that the resonance is not sharply confined to a single frequency, but extends over an appreciable range. The effect of this would be to flatten out the curve, improving the agreement at high and low temperatures, without materially affecting the agreement at the mean point where $z=3$, which corresponds approximately in the case of rock-salt and sylvine to the temperature of liquid air. The same type of curve represents many other isotropic substances qualitatively, but the appropriate frequencies cannot, as a rule, be determined by independent experiments. For anisotropic substances, such as ice and quartz, possessing different frequencies in different directions, a different type of formula would no doubt be required, although such cases might be represented empirically by an arbitrary selection of frequencies.

It is well known that the formula deduced by Einstein from Planck's equation by somewhat similar reasoning, does not give correct values of the specific heats when the Reststrahlen frequencies are assumed, although Planck's formula would be very difficult to distinguish from that here proposed by radiation methods. The reason may possibly be that the Planck-Einstein formulæ do not take any account explicitly of the pv term in the total energy, which, for the matter of that, is seldom or never mentioned in the theory of radiation, except in the deduction of the fourth-power law, where it is universally admitted.

The theory above sketched differs in so many fundamental points from that commonly accepted, that it may naturally be regarded with hesitation. It may be urged in apology that all such theories are necessarily based in the first instance on somewhat speculative analogies. The analogy assumed in the present case is very simple, and the results to which it leads are in good agreement with experiment. The same relations may be deduced and presented in many other ways, and the theory admits of many obvious extensions. But it seems best to reserve further details until the possibility of the fundamental assumption has been discussed by capable judges.

LXVII. *On the Structure of the Atom.*
 By Sir J. J. THOMSON, O.M., F.R.S.*

A LARGE and important class of atomic properties involves the relation $w=hn$ between the energy w communicated to some of the corpuscles in the atom and the frequency n of the light from which this energy is derived; h is Planck's constant, which is the same for every kind of atom and on the C.G.S. system of units $=6.5 \times 10^{-27}$, its dimensions are those of a moment of momentum.

Examples of this type of properties are: (1) photo-electric effects, where the corpuscles ejected under the influence of this light start with an amount of energy equal to hn ; (2) the relation between the "hardness" of Röntgen rays and the kinetic energy of the cathode rays which produce them; (3) the nature of the "characteristic" Röntgen radiation emitted by the atom and probably also that of its visible spectrum. In fact, all the effects produced by radiation, whether this be ordinary light or Röntgen rays, seem to be manifestations of this principle.

It is usual to regard Planck's equation as an indication that radiant energy is molecular in structure. I have suggested, in papers in the 'Proceedings of the Cambridge Philosophical Society' (vol. xvi. p. 643) and the 'Philosophical Magazine' (May, 1912), that the same result would follow without any such assumption as to the character of radiant energy, if the mechanism in the atom by which the radiant energy is transformed to kinetic energy is such as to require the transference to the mechanism of a definite amount of energy, sufficient, for example to rupture some system, before the transference can take place; that, in fact, Planck's relation depends on the properties of the atom, the agent by which the energy is transformed, rather than upon the existence of a structure in the energy itself.

In the following paper I have attempted to describe an atom of such a kind that the transformation of radiant into kinetic energy would take place in accordance with Planck's law.

Phenomena which involve this law seem especially suitable for consideration in connexion with theories of the structure of the atom, for their general character is the same for all atoms, and thus the mechanism to which they are due must exist in every kind of atom, and must, therefore, be of fundamental importance in any theory of atomic structure.

* Communicated by the Author. Read at the British Association, Sept. 11, 1913.

In considering the forces which may exist in the atom, we must remember that we cannot assume that the forces due to the charges of electricity inside the atom are of exactly the same character as those given by the ordinary laws of Electrostatics; these laws may merely represent the average effect of a large number of such charges, and in the process of averaging some of the peculiarities possessed by the individuals may disappear.

Thus it is possible that the force exerted by a single atomic charge may not spread out uniformly in all directions, but be concentrated along certain lines or cones. The lines of electric force springing from such a charge may not fill all the space around the charged particle; each particle may be the origin of a force which, instead of filling the space round it, may be confined to a narrow tube of force, outside which the particle produces no effect. In fine, we may attribute to the forces inside the atom a different distribution and character from that which might be expected if the forces due to the atomic charges obeyed in all respects the ordinary laws of Electrostatics. The only criterion we need apply to the forces inside the atom is that the properties which the atom would possess in virtue of these forces should correspond to the actual properties of the atom.

We shall now endeavour to show that properties of the kind we are considering would be possessed by the atom, if the character of the forces acting on a corpuscle in the atom was as follows:—

(1) A radial repulsive force, varying inversely as the cube of the distance from the centre, diffused throughout the whole of the atom, combined with

(2) A radial attractive force, varying inversely as the square of the distance from the centre, *confined to a limited number of radial tubes in the atom.*

With regard to these forces, one varying inversely as the cube, the other as the square of the distance, we may point out that they are the forces which occur most frequently in ordinary Mechanics. It is not necessary to elaborate this point with regard to the inverse square law. The force varying inversely as the cube of the distance is of the same type as ordinary "centrifugal force." It is the most usual type of force due to the kinetic energy of the system, when we regard forces as due to the inertia of systems connected with the primary one. In fact, much the same effects as are produced by the force varying inversely as the cube of the distance would be obtained, if there were something in the structure of the atom which compelled the moment of

momentum of a corpuscle about an axis in the atom to be an absolute constant whose value did not depend at all upon the nature of the atom. We shall not, however, at this stage enter into any consideration as to the origin of this force; we shall simply postulate its existence.

If a corpuscle at P were inside one of the tubes of attractive force inside the atom, it could be removed to an infinite distance (1) by moving it radially outwards and keeping it inside the tube of attractive force the whole way. If the attractive force on unit charge at a distance r from the centre is A/r^2 , the work required to move the corpuscle in this way from r to an infinite distance is Ae/r ; the corpuscle could, however, be moved to an infinite distance in another way (2) by moving it sideways out of the tube at P and then moving it outside the tube to an infinite distance—the latter process will absorb no work, as the attractive force vanishes outside the tube. By the Conservation of Energy the work must be the same whether we adopt process (1) or (2), hence the work required to move the corpuscle sideways out of the tube at P must be equal to Ae/r .

A corpuscle can be in stable equilibrium when in a region where it is acted on by both the repulsive and the attractive forces. Let the repulsive force on unit charge at a distance $r = C/r^3$, the attractive A/r^2 , then there will be equilibrium at a distance a if

$$\frac{C}{a^3} = \frac{A}{a^2}.$$

To show that the equilibrium is stable, suppose the particle is displaced radially through a distance x , so that $r = a + x$; then, if m is the mass of a corpuscle, e its charge, the equation of motion is

$$\begin{aligned} m \frac{d^2x}{dt^2} &= \frac{Ce}{(a+x)^3} - \frac{Ae}{(a+x)^2} \\ &= \frac{Ce}{a^3} \left(1 - \frac{3x}{a}\right) - \frac{Ae}{a^2} \left(1 - \frac{2x}{a}\right), \\ &= -\frac{Cex}{a^4}. \end{aligned}$$

Thus the motion is stable, and if T is the time of vibration

$$\frac{2\pi}{T} = \sqrt{\frac{Ce}{ma^4}}.$$

The work done by the repulsive force on a corpuscle when it moves from $r = a$ to $r = \text{infinity}$ is $\frac{Ce}{2a^2}$; hence we see that

this work, which we shall denote by w , is proportional to $1/T$, the frequency of the vibration; if $1/T = n$, we have

$$w = \pi \sqrt{Cem} \cdot n.$$

We shall choose C so that

$$\pi \sqrt{Cem} = h,$$

where h is Planck's constant 6.5×10^{-27} ; putting $e = 4.7 \times 10^{-10}$, $m = 5.3 \times 10^{17}$, we find $C = 10^{-17}$. Let us now consider some of the properties which an atom in which there are forces of this kind would possess. Take, first, the photo-electric effect. Suppose light of frequency n falls upon the atom, it will find some corpuscle with which it is in resonance and communicate energy to it. The corpuscle will not be able to get out of the tube of attractive force in which it is situated unless it receives sufficient energy to get sideways out of the tube. This amount of energy is, as we have seen, $\Delta e/a = Ce/a^2 = 2w$. When the energy reaches this value the corpuscle gets out of the tube, its kinetic energy being exhausted in the process. It now comes under the uncontrolled action of the repulsive force and acquires kinetic energy, the kinetic energy when the corpuscle leaves the atom being equal to the work done by the repulsive forces on the corpuscle as it moves from $r = a$ to $r = \text{infinity}$; this work is equal to $Ce/2a^2 = w$, and this, as we have seen, is equal to hn , where n is the frequency of the vibration and h Planck's constant. Thus we see that the kinetic energy with which the corpuscle is expelled is proportional to the frequency of the light and is equal to the frequency multiplied by Planck's constant. This is the well-known law of Photo-Electricity.

Though the energy communicated to the corpuscle by the light would, in the first instance, appear as an increased radial velocity, we can easily conceive ways by which the radial velocity might, without loss of energy, be turned into a sideways velocity. For example, if when the corpuscle was passing through the position of equilibrium it came under the influence of some casual magnetic force at right angles to the direction in which it was moving, the corpuscle would be deflected and the radial velocity would be diminished, while the sideways velocity would increase without there being any change in the kinetic energy. Thus we see that it is quite possible for a corpuscle when acted upon by light to continually acquire kinetic energy without any commensurate increase in the amplitude of the radial displacement.

An atom of this kind will only absorb radiant energy of frequency n by multiples of hn . For unless the corpuscle is displaced from the tube in which it is situated there can be no real absorption of energy; if a wave of light passed over it without displacing it from the tube it would leave the corpuscle vibrating with the same frequency as the light. The energy of this vibratory motion would be dissipated as electrical waves, *i. e.* as light, so that the only result would be a scattering of the light without absorption. When, however, the energy given to the corpuscle is sufficient to liberate it from the tube there is a real absorption of energy as the particle ceases to vibrate, and its energy is now given out in the kinetic form. Thus the energy is absorbed by units, the unit being the amount of energy required to liberate a corpuscle from its tube—this, as we have seen, is equal to $2hn$.

Next consider the conversion of potential into radiant energy by an atom of this kind. We regard the light as produced by a corpuscle falling from outside the atom into its position of equilibrium. It will arrive at this position with a certain amount of energy, which will be dissipated as light as the corpuscle vibrates about its position of equilibrium with the frequency n .

The kinetic energy possessed by the corpuscle when it falls to its position of equilibrium is

$$\frac{Ae}{a} - \frac{1}{2} \frac{Ce}{a^2} = \frac{1}{2} \frac{Ce}{a^2},$$

since

$$\frac{A}{a} = \frac{C}{a^2}.$$

If we call this energy w and n the frequency of the vibration we have (see p. 795)

$$w = hn.$$

Hence the potential energy of the corpuscle outside the atom is converted into that of light of frequency n by multiples of the unit hn . Hence we see that an atom of the kind we are considering will possess the properties of the real atom with respect to the phenomena which involve transferences to and fro between radiant and kinetic or potential energy.

The case for the existence of a repulsive force varying inversely as the cube of the distance is strengthened, I think, by the consideration of the theory of the production of Röntgen rays by cathode rays.

A cathode ray striking against an atom will penetrate into it until stopped by the repulsive force, then from the action of this force it will be repelled and ejected from the atom. As long as the corpuscle is inside the atom it will be accelerated and will therefore emit radiation, this radiation constitutes the Röntgen rays.

If the cathode particle approaches the atom radially, its equation of motion is

$$m \frac{d^2x}{dt^2} = \frac{Ce}{x^2},$$

where x is the distance from the centre at the time t . Integrating this equation we get

$$m \left(\frac{dx}{dt} \right)^2 = -\frac{Ce}{x^2} + mV^2,$$

where V is the velocity of the corpuscle before it strikes the atom.

Integrating this equation, and taking $t=0$ when the corpuscle is at its least distance from the centre of the atom, we have

$$x^2 = V^2 t^2 + \frac{Ce}{mV^2} = V^2 \left(t^2 + \frac{Ce}{mV^4} \right).$$

We see from this that the time during which the cathode particle is in the neighbourhood of the place where it is nearest to the centre of the atom (*i. e.* the time when its acceleration is greatest, and its radiation therefore the most vigorous) is measured by

$$\sqrt{\frac{Ce}{mV^4}} = \frac{1}{mV^2} \sqrt{Cem} = \frac{h}{\pi mV^2}.$$

If we take 2π times this time as corresponding to the time of vibration of the Röntgen rays, n the "frequency" of the rays will be given by the equation

$$n = \frac{mV^2}{2h} \quad \text{or} \quad \frac{mV^2}{2} = hn.$$

Thus Planck's relation holds between the "frequency" of the Röntgen rays and the kinetic energy of the cathode particles which produce them.

The total amount of energy in the Röntgen radiation is proportional to

$$\int_0^{\infty} \left(\frac{d^2x}{dt^2} \right)^2 dt;$$

or since

$$\frac{d^2x}{dt^2} = \frac{Ce}{x^3}$$

and

$$x^3 = V^2 t^2 + \frac{Ce}{mV^2},$$

the energy is proportional to

$$\begin{aligned} & \frac{1}{m^2} \int_0^{\infty} \frac{C^2 e^2 dt}{\left(V^2 t^2 + \frac{Ce}{mV^2} \right)^3} \\ &= \frac{3\pi}{16} \frac{mV^4}{\sqrt{Cem}}. \end{aligned}$$

Thus the energy in the Röntgen radiation is proportional to the fourth power of the velocity of the cathode rays which excites it; this result, which I gave in a paper in the 'Philosophical Magazine' (August 1907), has been confirmed by Mr. Whiddington's experiments.

We can get some idea of the magnitude of the attractive forces varying inversely as the square of the distance by considering the energy required to excite radiation in the atom. We assume that the mechanism of radiation is somewhat as follows. A corpuscle is driven out from a position of equilibrium in the atom, leaving such a position vacant; then either this corpuscle or some other falls into the vacant place, vibrates about the position of equilibrium, and dissipates the kinetic energy it has acquired by falling into it as radiant energy. Thus, to excite the vibration, we have to drive a corpuscle out of its position of equilibrium; if this is at a distance a from the centre of the atom, the work required is Ae/a , and since $a = C/A$ this is equal to A^2e/C .

Mr. Whiddington's experiments (Proc. Roy. Soc. A. vol. lxxxv. p. 323) show that, to excite the hardest characteristic Röntgen radiation, the K radiation, in an atom whose atomic weight is ϖ , the cathode particle must have a velocity not less than $10^8 \varpi$ cm./sec. The kinetic energy of one of these particles is thus not less than $\frac{1}{2} 10^{16} \varpi^2 m$; equating this to A^2e/C , we get

$$\frac{1}{2} 10^{16} \varpi^2 m = \frac{A^2 e}{C}.$$

Since $e/m = 5.3 \times 10^{17}$, $C = 10^{-17}$, we find

$$A = \varpi \times 3.1 \times 10^{-10}.$$

The charge on a corpuscle is 4.7×10^{-10} ; the force at a distance r , calculated by the ordinary laws of Electrostatics due to a charge ϖe , is $\omega \cdot 4.7 \times 10^{-10}/r^2$. We see, then, that the force along one of the tubes which contain the corpuscles which give the hardest characteristic Röntgen radiation, the K radiation, when they vibrate, is about the same in magnitude as would, according to the ordinary laws of Electrostatics, be produced by a charge of positive electricity between $\frac{1}{2}\varpi e$ and ϖe . If Whiddington's value for the velocity of the cathode particles is too great by about 20 per cent. the charge would be $\frac{1}{2}\varpi e$, if it were too small by about 50 per cent. the charge would be ϖe . The distance from the centre of the atom at which the corpuscles which produce these hard rays are situated, is C/A or

$$\frac{1}{\varpi} 3.2 \times 10^{-8} \text{ cm.}$$

Let us apply this result to the case of hydrogen; we shall suppose that in this case $\varpi e = A$ or, since $\varpi = 1$, $A = e$. The frequency of the characteristic radiation is (see p. 794) given by the equation

$$4\pi^2 n^2 = \frac{Ce}{ma^4} = \frac{e}{m} \frac{A^4}{C^3},$$

since $a = C/A$.

Putting $A = e$, and substituting the values for C and e , we find

$$n = 8.2 \times 10^{14}.$$

This frequency corresponds to light just in the ultra-violet. The most interesting thing about this result is, however, that, within the errors of experiment, the frequency we have found coincides with that of the head of the series of hydrogen lines given by Balmer's law, so that this spectrum represents the K radiation for hydrogen. As hydrogen possesses in the Schumann region a spectrum of still greater frequency, it seems probable that the K radiation may not be the hardest type of characteristic Röntgen radiation.

If for helium we assume $A = \frac{1}{2}\varpi e$, the corresponding value of n would be 3.288×10^{15} ; this corresponds to radiation in the Schumann region. For heavier elements the frequency would be of an order corresponding to Röntgen rays.

LXVIII. *Intelligence and Miscellaneous Articles.*ON THE ELECTRIFICATION OF THE ATMOSPHERE AND
SURFACE OF THE EARTH.*To the Editors of the Philosophical Magazine.*

GENTLEMEN,—

I THINK Dr. Karl Bergwitz's interpretation of my experiment is not correct, because it made no difference in the final result, whether the plate was connected to the electroscope before or after raising from the earth. What might be said in criticism is that the plate when elevated simply gave the charge present in the air, but I believe this not to be the case, because it was so much greater.

I think the surface condition of the earth in hot dry places may be very different from that observed in European countries. At the place where my observations were taken you could not discharge an electroscope quickly by merely putting a wire in connexion with the surface; in fact locally the surface layer was an insulator. As I pointed out in my communication, very different results would probably follow in wet weather.

Yours faithfully,

W. A. DOUGLAS RUDGE.

THE MAGNETON AND PLANCK'S UNIVERSAL CONSTANT.

To the Editors of the Philosophical Magazine.

GENTLEMEN,—

In the discussion on the Theory of Radiation at the British Association Meeting just concluded, Dr. Bohr's postulate of a natural unit of angular momentum was very prominent. The unit actually exists and is to be found in the magneton (See "A Theory of Gravity" in this number of your Magazine). A magneton of any cross-section or aperture has, I find, the angular momentum about its axis

$$(8\pi^2 V)^{-1} N_e N_\mu.$$

V is the velocity of light. N_e is the number of tubes of electric induction terminating on the surface, N_μ the number of tubes of magnetic induction passing through the aperture. I hope with your permission to discuss in another number the meaning of this result for a theory of radiation and matter. By making Planck's h an angular momentum, Dr. Bohr has introduced an idea of the first importance.

I am, Gentlemen,

Yours faithfully,

University College, Reading.

S. B. McLAREN.

FIG. 7.

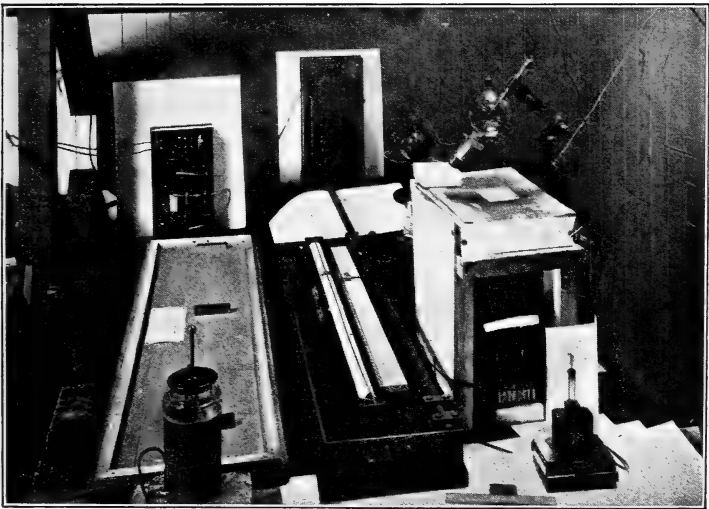

General view of Final Arrangements.

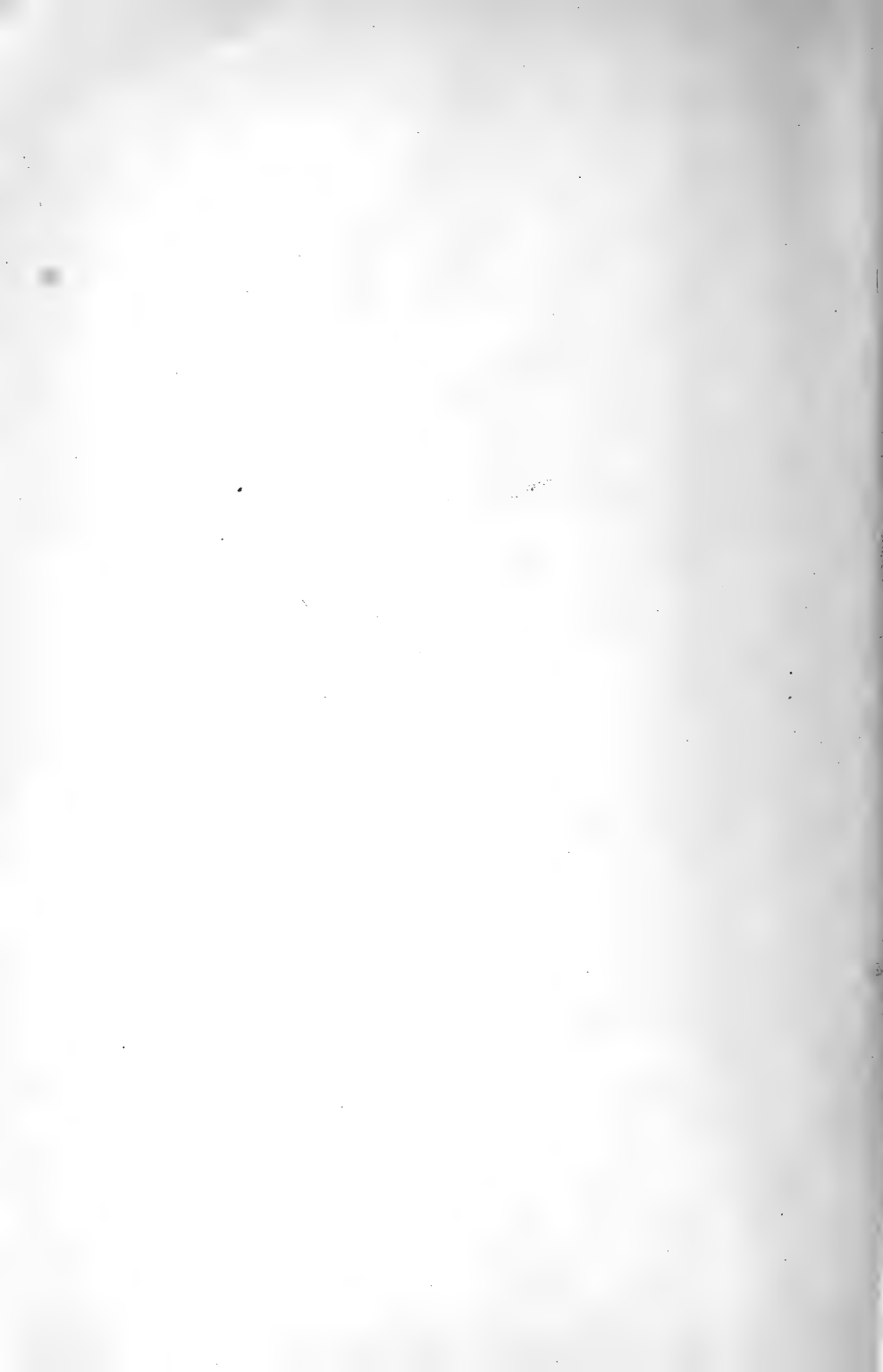

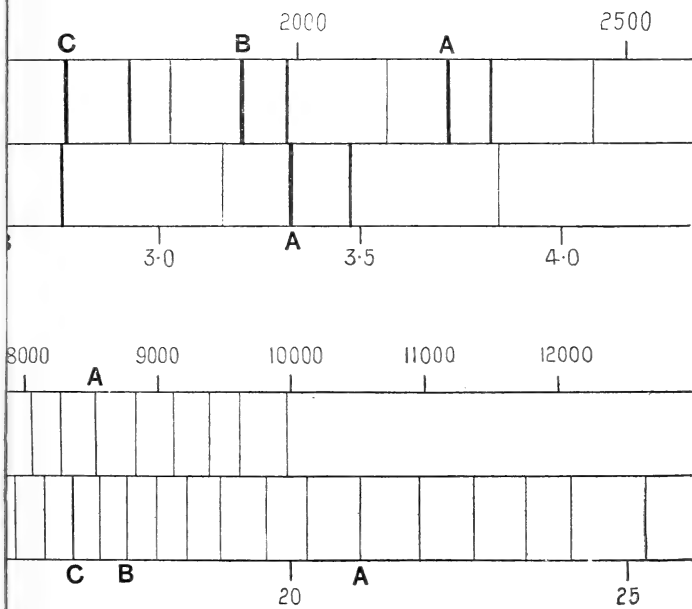
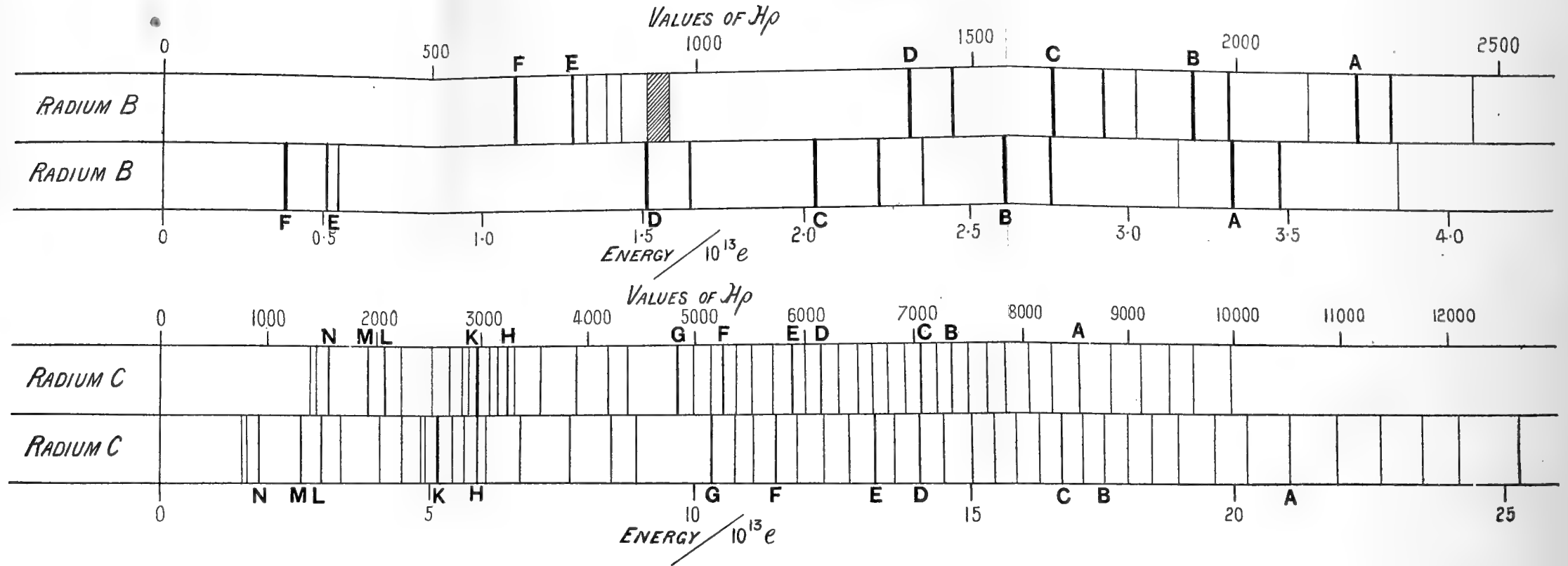



FIG. 2.



THE
LONDON, EDINBURGH AND DUBLIN
PHILOSOPHICAL MAGAZINE
AND
JOURNAL OF SCIENCE.

[SIXTH SERIES.]

NOVEMBER 1913.

LXIX. *The Distribution of Energy in the Spectra of Gases.*
By H. L. P. JOLLY, M.A., late Senior Scholar, Trinity
College, Cambridge*.

[Plates XIII. & XIV.]

CONTENTS.

	Page
1. Introduction	801
2. Summary of Previous Work on the Subject	803
3. Description of Preliminary Experiments	805
4. Experiments with a Paschen Galvanometer	808
A. The radiation from the non-disruptive discharge in hydrogen	809
B. Displacement of energy in the spectrum	816
C. The continuous distribution of energy in the spectrum	823

1. INTRODUCTION.

THE object of the investigations described in this paper was, in the first instance, to determine quantitatively the manner in which the energy distribution among the lines of a bright line spectrum varied when the intensity of excitation was changed. Prof. Sir J. J. Thomson had suggested that Planck's theory of indivisible "quanta" of radiant energy might manifest its truth in a discontinuous or step-like change in the intensity of a spectrum line; in other words, that the relative energy of two lines belonging to a series might change in a manner represented by small

* Communicated by Sir J. J. Thomson, O.M., F.R.S.

integral numbers. Such a manifestation would demand two essential conditions, namely, that the number of "elementar-quanta" emitted by each of the centres of radiation during an active period be small, and, further, that an increased excitation represents an increased intrinsic energy of the individual oscillators, and is in no way connected with an increase in their number.

Unfortunately, it appears certain that the latter condition is radically impossible in the discharge of electricity through gases. Indeed, there is reason to believe, as will be shown later, that the number of centres of emission is actually proportional to the amount of current passing. Further, it should be realized that, even if a simple numerical relation between the changes in energy of spectrum lines existed, the accuracy with which these measurements can be carried out is quite inadequate to establish any but the simplest of such relations. To express this more clearly: suppose that the energy of two lines α and β were represented by mh_α and nh_β , where "m" and "n" are whole numbers, and that changes in these values could only give rise to terms $(m+1)h_\alpha$, $(m+2)h_\alpha$... &c. due to the one line, and $(n+1)h_\beta$, $(n+2)h_\beta$... &c. due to the other line, then the statement in the previous sentence means that this discontinuous changing of the energy of the lines could only be established in the cases in which m and n were small integers.

The extreme difficulty of the measurements arises in several ways. In the first place, the total amount of energy emitted as radiation from gases in discharge-tubes is extraordinarily small, and, as will appear in the sequel, a large amount of time and experimenting has been bestowed upon this point alone. When we consider the low pressure of the gas under observation, the small amount of energy is not surprising. A column of air at 1 mm. pressure enclosed in a capillary tube of 1 mm. diameter (such as has been used in the present experiments) would, if compressed to the same density as solid platinum, have a diameter of 3 μ . A platinum wire of these dimensions would, if not self-luminous, be almost invisible to the naked eye.

Apart from this purely quantitative difficulty there is another—the apparent capriciousness of all discharge-tubes.

Those who have studied the spectra of gases qualitatively have complained one and all of the difficulty of reproducing exactly from one day to another the behaviour of a gas in a discharge-tube. Changes occur for which none but tentative explanations can be given, and the maintenance of a constant gaseous source for spectroscopic investigations, let us say,

over the space of one day, is a practical impossibility. The electrodes emit and re-absorb various gases, and are on this account a continual source of trouble.

We may say a few words here as to the comparative merits of thermal and photometric methods of measurement. The great advantage of the latter method is that very much smaller amounts of radiant energy can be compared. On the other hand, the thermal method, especially the thermopile, gives an *immediate* effect proportional to the energy received. There are no sources of error such as comparison standards, personal equation, &c. Further, the setting of a photometric apparatus is an operation requiring far more time than a thermopile reading. It is true that the best thermal measuring-instruments are as yet unable to give measurable readings for any but the very strong lines in the spectra of gases, but improvements in this direction are possible.

2. SUMMARY OF PREVIOUS WORK ON THE SUBJECT.

Investigations on the radiations from gases in discharge-tubes have been made by the following, among others:—

GREENWICH OBSERVATIONS. 1887.

ÅNGSTRÖM. *Ann. der Phys.* vol. xlvi. pp. 493-531 (1893).

J. J. THOMSON. *Proc. Roy. Soc.* vol. lviii. p. 244 (1895).

KALÄHNE. *Ann. der Phys.* vol. lxxv. pp. 815-848 (1898).

FERRY. *Ann. der Phys.* 1899, vol. lxxix. pp. 398-425; *Phys. Review*, 1898, vol. vii. pp. 1-9 (1898).

LEWIS. *Ann. der Phys.* vol. lxxix. pp. 398-425 (1899).

LANGENBACH. *Ann. der Phys.* vol. x. pp. 789-815 (1903).

BERNDT. *Ann. der Phys.* vol. xii. pp. 1101-1114 (1903).

WAETZMANN. *Ann. der Phys.* vol. xiv. pp. 772-790 (1904).

GEIGER. *Ann. der Phys.* vol. xxii. pp. 973-1007 (1907).

PFLÜGER. *Ann. der Phys.* vol. xxiv. pp. 515-526 (1907).

PASCHEN. *Ann. der Phys.* vol. xxvii. pp. 537-570 (1908).

LADENBURG. *Verh. d. D. Ges.* vol. x. pp. 550-561 (1908); *Ann. der Phys.* vol. xxxviii. pp. 249-318 (1912).

NUTTING & TUGMAN. 'Nature,' vol. lxxxi. p. 189 (1909); *Astroph. Journal*, vol. xxxi. pp. 62-75 (1910).

The results obtained by the experimenters mentioned above do not at first sight appear to form a consistent whole. But it must be remembered that the experiments described refer to almost every conceivable method of producing a discharge, and that the other conditions varied much in the work of the different observers. There seems no doubt that the energy of the total radiation, and therefore the energy of any line, in the spectra of the permanent

gases is related to the current-density in a manner represented at least roughly by a linear law. Probably it is an essential condition for the observance of this that the tube be not too narrow and the pressure not too high. In other words, the current-density must not be too great. A large increase of pressure makes it necessary to employ a large capacity in conjunction with a spark-gap in order to obtain a luminous discharge. These are exactly the conditions for obtaining a large current-density for very short intervals of time, and a proportionality between current-strength and radiation would not be expected. In any case these large momentary values of the current are extremely difficult to measure. It seems probable that for current-densities below a certain value the proportionality law holds. (Nutting & Tugman assert this as an experimental fact.) Thus it is noticeable that all the observers who put forward the law worked either with low currents (Ångström, Ferry, Berndt, Waetzmann) or with wide tubes (Geiger).

Such a law is attractive because of its simplicity, but there can be no doubt that at higher pressures and larger current-densities no such simple conditions occur. The nature of the causes producing radiation, then, presents a problem as yet quite unsolved. As to the exact form of the relation between current-density and radiation when no direct proportionality exists, some such relation as that suggested by Nutting & Tugman may represent the facts, though photometric measurements are susceptible of no great accuracy.

It may be that no definite relation exists unless other variables, such as pressure, width of tube, cathode fall of potential, potential gradient, &c., be included in the formula. The important point on which to obtain information is the relative change in energy of different parts of the spectrum.

Pflüger (also Ladenburg) showed conclusively that absorption in hydrogen depends on the gas being ionized, or at least on its being in a state associated with the passage of an electric current through it. The appearance of a continuous spectrum at higher pressures and larger current-densities is suggestive of a temperature radiation. That it is not a purely temperature effect was shown by Pflüger, in the case of mercury vapour.

Nearly all of the work mentioned in the previous summary deals with measurements made on the spectrum as a whole.

Mention should also be made of some interesting work on slightly different lines by Lunkenheimer (*Ann. der Phys.* vol. xxxvi. p. 134, 1911) and a very comprehensive series of

experiments by Vegard (*Ann. der Phys.* vol. xxxix. pp. 111-169, 1912). In agreement with Paschen and Lunkenheimer, Vegard finds that the distribution of energy in the spectrum of the light from *Kanalstrahlen* is independent of the velocity of the latter, but that the distribution in the spectrum of the light excited in the stationary atoms by the *Kanalstrahlen*, though independent also of the voltage, differs markedly from the distribution in the moving atoms. This explains the apparent shift of energy with changing voltage, observed in the transverse light, for the difference between the distribution in the "stationary" and "moving" intensity changes with the voltage, and also becomes less marked as the pressure is lowered.

An observation of Sir J. J. Thomson's (*loc. cit.*) to the effect that the ratio in intensity $\frac{H_\alpha}{H_\beta}$ is greater in the positive column than in the negative glow is also confirmed.

These results throw much light on the subject of the radiation from Geissler tubes, but owing to the widely differing ranges of pressure in the two papers mentioned and the present paper, a direct comparison of results is impossible. In the present case such high pressures were necessary in order to obtain sufficient energy that it is doubtful whether the pressure-effects found by other observers at pressures below 1 mm. of mercury have much significance.

3. DESCRIPTION OF PRELIMINARY EXPERIMENTS.

The experiments were commenced in the summer of 1909. At first an attempt was made to obtain measurable amounts of energy by using Plücker tubes in conjunction with a Rubens thermopile and a d'Arsonval galvanometer. Several forms of discharge-tube were tried, but all failed. A Broca galvanometer was next tried. The sensitiveness of this instrument was 3×10^{-9} amp. for 1 mm. deflexion when the period of oscillation was 17 sec. This again proved insufficient when working under its ordinary conditions, as the deflexions for the total energy in the visible spectrum were never more than 2 or 3 mm. on the scale.

The Broca is, incidentally, scarcely suited for this kind of measurement for another reason:—The suspended system is a heavy one, and the time of oscillation large, so that measurements of first swings cannot be made with that rapidity which is so desirable when the source is liable to fluctuations, and when, owing to the smallness of the effect

measured, the disturbances from outside are to be contended with. Under the circumstances, three paths seemed open to bring the measurements within the region of possibility. The galvanometer could be made aperiodic, by decreasing the controlling force on the magnet-system. The length of the optical path used to read the deflexions could be increased, if care were taken with the optical arrangements.

Finally, it seemed worth while to try to improve on the means of obtaining a concentrated supply of radiation from a gas in a discharge-tube. All of these improvements were tried, and as a result of pushing the sensitiveness of the galvanometer further, some comparatively large deflexions were obtained. But every physicist knows the futility of working with an instrument which has been coaxed into ultra-sensitiveness.

A description of some of the observations with the Broca galvanometer will be given as part of the sequence of the work, but no real scientific value is claimed for them.

As source of current a Ruhmkorff coil was at first used, and later a transformer which took the 100-volt supply directly.

Fig. 1 represents the forces acting on the magnet-system.

Fig. 1.

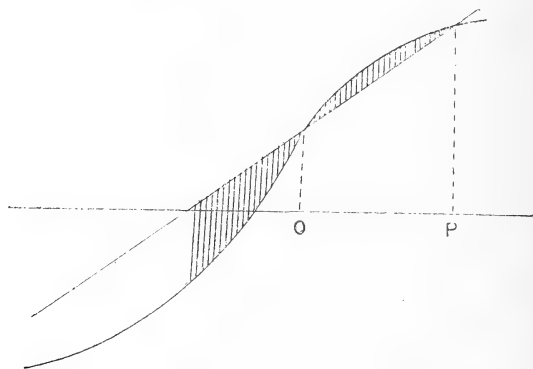

The couple due to the earth's field is represented by the sine curve, and the torsional couple of the suspending fibre by the straight line. The resultant couple is given by the vertical height of the shaded area, and it will easily be seen how unstable the system may become when the loop is made narrower so as to increase the sensitiveness. The equilibrium position is O, but if the system should be driven beyond the

point P, it would not return. This happened to a wearisome extent in practice. If the straight line were made to cut the curve in the opposite sense, no unstable regions would occur, but the region near the equilibrium-point would then degenerate much sooner into a state of neutral equilibrium as the slope of the curve approximated to that of the straight line.

The smallest changes in the earth's magnetic field are sufficient to cause a wandering of the spot of light.

As regards the means of reading the mirror, some trouble was bestowed on this point. A collection of astigmatic lenses was obtained, and, after trying several of these, one was found which would give a fairly satisfactory image of a silk fibre at a distance of 8 metres. Nearly all mirrors are warped in some plane, which is in general neither horizontal nor vertical, making it impossible to obtain an image of a vertical thread. The accurate orientation of the lens was in the present case of extreme importance, and the scale could be read at best to $\frac{1}{2}$ mm.

The measurement of the current, which throughout has been somewhat difficult, was made by means of a rough electro-dynamometer. On passing the discharge through this instrument the spot of light which measured the current was never steady, and an estimate of the mean current had to be obtained by observing rapidly the extremes of the swings over 4 or 5 of the latter.

The same scale was used for both galvanometer and dynamometer, with a Nernst lamp as source of light.

An observation involved the following operations:—

The pressure was read first of all (p_1 in schedule).

The current in the discharge-tube was turned on and allowed to run for a short time. A watch being held in one hand, the shutter was opened by means of a long string when the second-hand pointed to "60," allowing the rays to fall on the thermopile.

At the same instant the zero reading of the galvanometer was taken (r_0 in schedule). Readings r_0 , r_1 , &c. were taken every 5 seconds, beginning with the zero reading.

At the $\frac{1}{2}$ -minute these readings were discontinued, and a few readings of the dynamometer were jotted down during the next $\frac{1}{2}$ -minute (a_1a_2 , b_1b_2 , &c.). At the end of 1 minute the galvanometer was again read (r) and the current was stopped.

Another minute was allowed to elapse and the zero reading again taken (r_0'). A final reading of the pressure completed the observation (p_2).

The deflexion was taken as $\frac{r_0 + r_0'}{2} - r$.

Readings for press.	Means.	Number α press.	Current.				Thermopile.			
			a_1	a_2	a	} Mean	r_0	r	r_0'	R.
p_1	p	P	a_1	a_2	a		} Mean	r_0	r	
p_2			b_1	b_2	b					
			c_1	c_2	c					
			d_1	d_2	d					

The results of one series of such readings are plotted in Curve 1 (Pl. XIV.), but all that can be determined from it (and from others of a similar nature) is a general increase of radiation with current, the relation being not far from linear.

In the course of the work various forms of discharge-tube were tried, some of which are depicted in fig. 3 (Pl. XIII.).

A plan of the apparatus used in the foregoing experiments is given in fig. 2 (Pl. XIII.).

4. EXPERIMENTS WITH A PASCHEN GALVANOMETER.

In the summer of 1911 a visit was paid by the writer to the laboratory of Prof. Paschen in Tübingen, for the purpose of procuring a sensitive galvanometer.

The galvanometer is essentially of the Thomson astatic type, and every conceivable modification tending towards increased sensitiveness has been made. One of the great objects in view is the decreasing of the weight and moment of inertia of the suspended system, so that a given sensitiveness may be accompanied by as small a period of oscillation as possible. Fig. 4 represents the two back coils with the suspended system when the front pair of coils has been removed. A section through these coils by a plane at right-angles to the paper is drawn at the side. It will be noticed that the central portion of the coils is elliptical, and fits exactly the outlines of the magnet systems. The other concentric lines mark off regions in which different thicknesses of wire are used, the principle being that for every increment of resistance a proportional increase is made in the galvanometer constant.

Fig. 4.

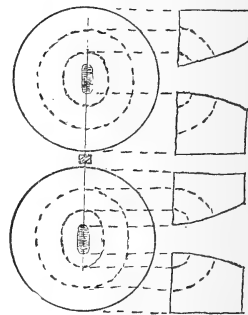

This principle was explained by Clerk-Maxwell in his 'Treatise.'

For purposes of comparison the sensitiveness of galvanometers is expressed in terms of certain standards. We speak of the *Normal Sensitiveness*, which is defined as follows:—

Let i = current in amperes,
 T = period of swing,
 R = resistance of galvanometer,
 d = distance of scale from mirror, in metres,
 s = scale deflexion in mm.,

then the normal sensitiveness is

$$S = s/d \cdot 10^2/T^2 \cdot 10^{-6}/i \cdot 1/\sqrt{R}.$$

Thus it is the deflexion produced at a distance of 1 metre when a current of 10^{-6} ampere is passed through the galvanometer, the time of swing being brought up to 10 secs. and the resistance being 1 ohm.

The normal sensitiveness of the Paschen galvanometer is 4000, and the whole suspended system weighs less than 5 mg.

A further description of the instrument is to be found in Prof. Paschen's own writings.

The experiments to be described comprise:—

- A. An examination of the radiation from the non-disruptive discharge in hydrogen. Owing to the small energy-content of the radiation, these were confined to measurements of the total visible radiation, as transmitted by glass lenses.
- B. Investigations as to the existence of a displacement of energy in the spectrum with increased current-density. For these, a large condenser had perforce to be introduced into the circuit, to supply the necessary energy. In some of the experiments a spark-gap was also introduced in series with the discharge-tube, thus giving a still further increase in energy.
- C. An examination of the continuous distribution of energy in the same disruptive discharge in hydrogen at pressures ranging from 1 to 10 cm. of mercury.

A. *The Radiation from the non-Disruptive Discharge in Hydrogen.*

For the measurement of the current in the discharge-tube various methods were tried. The electro-dynamometer proved unsuitable for the reasons mentioned. An attempt was also made to set up a thermo-couple with a platinum

wire stretched across it, the platinum wire carrying the discharge-tube current. But when used in connexion with a Thomson astatic galvanometer this arrangement did not prove sufficiently sensitive.

A method which gave better results was to measure the mean potential difference between the ends of a known (non-inductive) resistance in series with the discharge-tube.

This potential difference was measured at first by a gold-leaf electrometer, and some consistent readings were obtained. But the necessity of calibrating the gold-leaf after each set of observations rendered the method very tedious.

A curve obtained in this way, showing the variation of current when the source of E.M.F. was kept constant and the pressure allowed to vary over wide limits, is appended (curve 3, Pl. XIV.).

The less steep curve represents the same observations plotted with the abscissæ on a scale 10 times as large, so as to show the behaviour of the curve at lower pressures.

Obviously, from the regularity of the curve, this method of measuring small alternating currents is a practicable one.

The mean potential difference between the ends of a known resistance was later measured by an alternating voltmeter specially made for a frequency of 90 per second.

Finally, in connexion with the measurement of the currents, experiments were made in which a discharge-tube of the form shown in fig. 5 (Pl. XIII.) was placed in series with the tube used as source of radiation. Each electrode consists of a long brass rod about 3 mm. in diameter, and the two are placed as nearly as possible co-axially. According to H. A. Wilson's experiments, the length of the glow on the cathode is nearly proportional to the current and inversely proportional to the pressure.

We have, therefore, a method of determining not only the maximum current but also the variation of its value over the natural cycle of $1/90$ sec., for by examining the tube in a rotating mirror we may draw out its image into a shape like that shown above, clearly indicating the sinusoidal waveform of a purely alternating current.

When a condenser discharge is sent through such a tube, interesting variations of the above curve are obtained. The glow on the cathode does not always extend to a uniform length on all sides of the rod, and may make a measurement of its mean length difficult. Further, it is doubtful whether the length is proportional to the current in the case of the condenser discharges, where we have a very large current passing for a very short time a certain number of times per

second. This latter number is, unfortunately, not fixed and definite.

The appearance of the image in the rotating mirror is shown in fig. 6 (Pl. XIII.) for three cases.

In the first there was no condenser in parallel with the discharge-tube, and we have the sine-curve characteristic of the alternator. The second case is that of a condensed discharge at higher pressure, but without a spark-gap in series with the tube. It is to be noticed that the current, during the early part of each cycle, is running into the condenser and not through the discharge-tube.

When a certain potential is reached the condenser empties itself through the discharge-tube and gives rise to a very high peak in the curve. The finite width of this part of the curve results only from the finite width of the glow on the electrodes in the measuring-tube, and does not mean that the condenser current lasts for a time comparable with the alternating current. The condenser discharges itself but once in each cycle, and the rest of the curve is therefore similar to the curve obtained in the absence of a condenser. Another point to be noticed is that only during the instant when the condenser is discharging itself is the space between the electrodes of the measuring tube luminous.

The third figure shows the appearance in the rotating mirror when a spark-gap is introduced in series with the two tubes.

Fig. 7 (Pl. XIII.) is a diagram of the arrangement in this case.

The current is now only able to pass when the potential difference between the spark-balls S exceeds a certain value.

The course of a cycle is probably something as follows:—

The potential difference between the ends of the transformer, and therefore between the plates of the condenser, rises uniformly at the beginning of the cycle, and when a certain potential difference exists the spark-gap S is broken down and a large current flows through the tubes, being indicated in the mirror by a peak in the image.

Now, the potential difference between the plates of the condenser is given by

$$E - R \cdot i,$$

where E = voltage of transformer (i.e. $\frac{\partial N}{\partial t}$) at the particular instant, R = resistance of transformer (secondary coil), and i = current passing.

Hence, as soon as “ i ” increases to a large value, the

potential difference available for breaking down the spark-gap falls below the necessary value, and the discharge ceases.

This process may be repeated many times in a given cycle, but when the spark-length is approaching the maximum permissible, the number of such peaks occurring in each half-cycle may be as small as 3, 2, or even 1. Thus we cannot be certain of reproducing the conditions at two different times when it might be desired to compare the energy of one line in the spectrum with that of another. The fact that each of the peaks represents a current passing for a very small fraction of a second (*i. e.*, a fraction of quite a different order from the $1/90$ sec. characteristic of the current supply), was established by observing them in an apparatus with 7 small mirrors fitted to a drum which was caused to rotate at about 50 revolutions per sec. This arrangement would have been able to detect a duration of the current over an interval of time as small as 10^{-4} sec. No such duration was apparent, and the image was as depicted in fig. 8 (Pl. XIII.).

A single cycle is spread out by such an image into a band, only a very small portion of which can be seen in any one mirror. This portion may or may not contain one of the few peaks belonging to each cycle. The next mirror as well as several succeeding ones will still show a portion of the same cycle, but only certain isolated ones will show a peak.

We thus have a peak shown by, say, the N th mirror, the $N + P$ th, the $N + P + Q$ th, and so on. The positions of these peaks will depend on the constant frequency with which one mirror takes the position of the previous one, and the irregular frequency of recurrence of a condenser discharge. They therefore appear quite at random in the field of view, both above and below the line (fig. 8).

The discharge-tube which was used as source of radiation was, in these later experiments, of quartz. Fig. 9 is a diagram of two of the tubes. Each electrode in the larger tube consisted of a thin-walled brass tube with a lump of zinc soldered on to the end.

They were also water-cooled so as to prevent the fusing of the sealing-wax joints. The bulbs were about 4 cm. in diameter, and the capillary portion about 1.8 cm. long and 0.7 mm. internal diameter.

The smaller tube had given good results, but owing to the thinness of the capillary portion and consequent puncturing on the passage of a heavy discharge, it had to be abandoned in favour of the larger tube. Unhappily, after only two

curves of the energy in the spectrum had been obtained, this tube was broken in the process of cleaning. The capillary

Fig. 9.

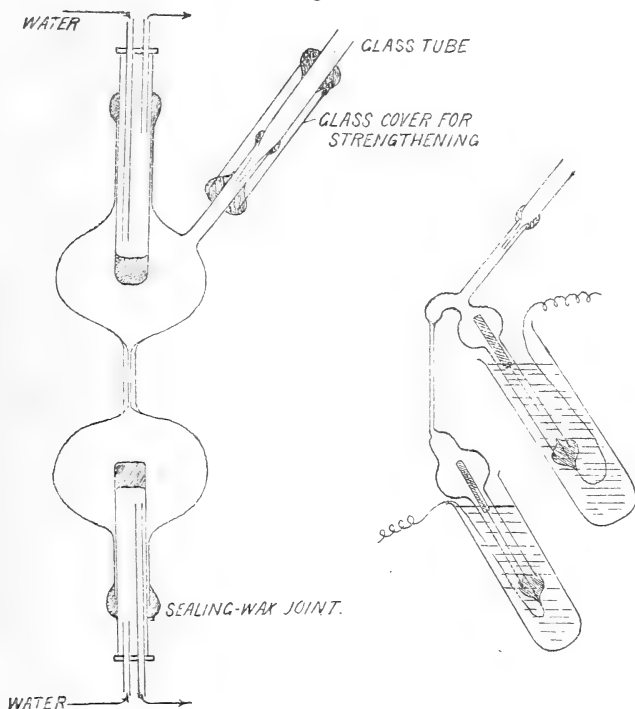

portion not being much damaged, it was found possible to mend the tube with one of the bulbs from the smaller apparatus, and the arrangement depicted in fig. 10 (p. 814) was resorted to. Immersing the whole in water seems to give more consistent results than are otherwise obtained, and it is not necessary to wait so long between observations for the necessary cooling.

Before giving a curve showing how the total radiation varies with the current when the latter is not disruptive, we reproduce a curve (2 A, Pl. XIV.) showing electrometer deflexions against potentials, so as to show that the region over which the leaf moved was one capable of giving reliable readings.

The potentiometer method of varying the potentials was adopted, and it was assumed that the current through the discharge-tube and the potentiometer resistance in series remained constant. This can easily be tested subsequently

by obtaining any two points on the curve with direct application of potential from cells, and finding out whether the resistances corresponding on the first curve to the two given deflexions are in the same ratio as the two potentials applied.

Fig. 10.

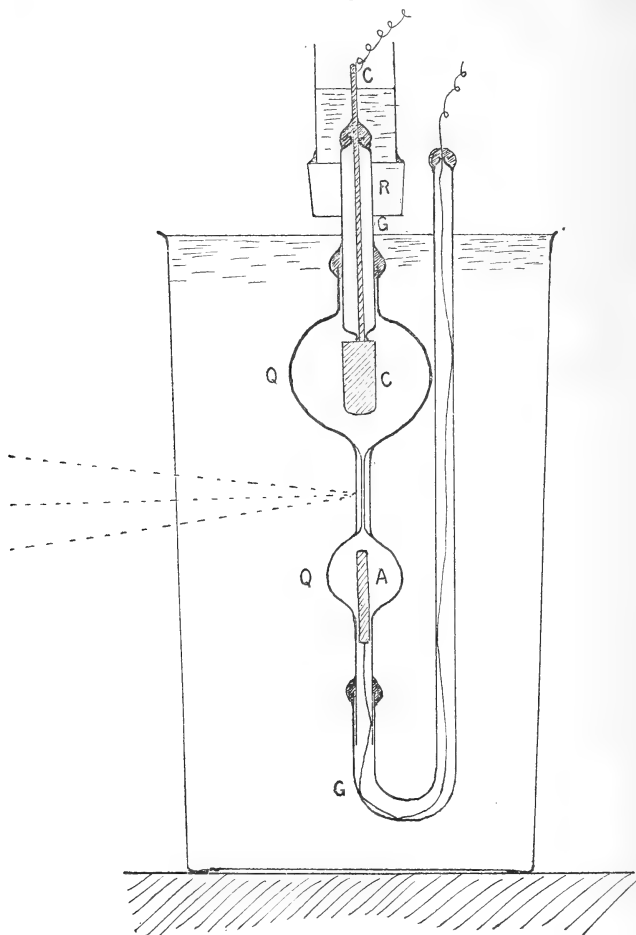

Q=Quartz.
G=Glass.
A=Aluminium.

C=Copper.
R=Indiarubber.
Sealing-wax joints dark shaded.

The general regularity of the potentiometer curve is also an indication that the current has not varied in any irregular

manner. It is somewhat remarkable that the Curve 2 A should be linear over so great a portion of its length, for this does not generally happen, as is shown by Curve 2 B, which is another of the same sort. The calibration of the electroscope is given in Table I. On the curve obtained from the discharge current we find that a deflexion of 39.9 divisions corresponds with a potentiometer resistance of 7780 ohms. Therefore 128 volts correspond with

$$128/172 \times 7780 \text{ ohms} = 5790 \text{ ohms,}$$

against which we find on the curve a deflexion 25.3 divisions, agreeing to within 2 per cent. with the 25.7 obtained.

Corresponding to 86 volts is $86/172 \times 7780 = 3890$ ohms, and the deflexion should be 7.4. The observed value is 7.3. If the deflexion is greater than 15 divisions, the curve shows that we may compute the current from the formula

$$i = 1/r(3100d + 48000),$$

where d = electroscope deflexion, r = potentiometer resistance.

Thus a certain current gave $d = 18.3$, when r was 8000, while on decreasing r to 5000, d was only 2.1. From the accurate part of the curve we obtain

$$i = 1/8000(3100 \times 18.3 + 48000) = 13.1 \text{ milli-amperes.}$$

Making use of the small deflexion 2.1 division, the curve shows that this would have been given in the previous case by 3120 ohms. This corresponds with $(172/7780) \times 3120$ volt, *i.e.* with $(172/7780) (3120/5000) \times 1000 = 13.8$ milli-amperes, which agrees well enough with the value 13.1 obtained from the accurate part of the curve.

TABLE I.

Voltage.	Deflexion.
128	19.3 } 25.7 45.0 }
172	19.1 } 39.9 59.0 }
86	19.1 } 7.3 26.4 }

The results indicated by Curve 3 (Pl. XIV.) are not vital to the present investigation, but were obtained as a test of the electroscopes method of measuring small alternating currents. But it is useful to know at what pressures one must guard most carefully against a change of pressure in measuring the radiation from the discharge.

Curves 4 and 5 are important. They show the relation between the total radiation in the visible spectrum and the current-density. The first of them was obtained by taking only one reading for each point, and the values representing intensity of the radiation are liable to errors whose magnitude can be gauged from the curve. Curve 5 is a similar one in which four readings went to each point. The greater regularity of this curve is to be attributed not only to the more numerous observations, but also to the lower pressure in the discharge-tube. There seems little room for doubt that up to the current-density observed (about 100 m.a. per sq. mm.), the energy of total visible radiation, and therefore of any given line, varies directly as the current-density. Under these circumstances there would be little gain in examining single lines with a view to proving the same proportionality in their case, and we proceed with the investigation of condensed discharges.

B. *Displacement of Energy in the Spectrum.*

Obviously, from the smallness of the deflexions obtained in the above curve, we must have a stronger source of energy if any spectroscopic separation is to take place. The only possible way is to examine the spectrum of the condensed discharge.

So far our observations have been concerned with the steady discharges produced by the alternator alone, and although the discharge-tube was placed close up to the slit of the spectrometer, there were no disturbances of the galvanometer due to the turning on of the current. (It should be explained that the only possible method of observing was to watch the galvanometer when the current was suddenly put on, as the heating would be too great if the current were allowed to run continuously and a shutter opened when desired.) Unfortunately the disruptive discharge caused a marked disturbance in the suspended system of the galvanometer, and it became necessary to investigate carefully the magnitude and constancy of these spurious deflexions. The sum-total of the disturbing effects may be stated as follows :—

- (1) Outside effects, whose magnitude and direction might vary. These would vitiate the smaller readings to a greater extent than the larger. A time must be chosen when the system appears as quiescent as possible, and in the present case this has precluded the possibility of relying on any readings obtained either after 8 o'clock in the morning or before 6 o'clock in the evening. At the best of times the system would "wobble" over not more than about 0.3 mm., although there might be a slow creep of the zero which would not affect the readings to any degree.
- (2) An effect due to the magnetic field of the transformer was noticed, but it was not very great. In order to obviate it the transformer was moved into the next room so as to be at least 25 feet away from the galvanometer.
- (3) An effect due to the proximity of the discharge-tube to the slit of the spectrometer. This was partly of the nature of an electrostatic induction, for it was lessened on earthing the spectroscope. Both this and the previous cause of disturbance affect the smaller readings to a greater extent than the larger.
- (4) The rapid electric oscillations seem to have an effect on the control-magnet of the galvanometer, for even when there was a space of some 20 feet between the oscillatory circuit and the galvanometer there was a small residual disturbance. For some unexplained reason it was very much greater when the spark-gap was immersed in oil.
- (5) The most influential source of inaccuracy, especially when large currents were used, was the variation of the strength and conditions of the discharge itself. From the electrometer curve (no. 1 A) and from the radiation curve (no. 5), it is clear that with uncondensed discharges the current does remain fairly constant, but the great heating in the case of the disruptive currents makes this sort of error by far the most formidable. There is this advantage, that the errors so occasioned will affect all readings in the same proportion.

The conditions which make for constancy in the readings have been carefully investigated.

When the galvanometer-circuit is closed the deflexions are larger than when it is open, and appear to have a tendency to be negative in sign. When the radiation is being

measured in the ordinary way, a mean deflexion may be obtained by subtracting the mean disturbance from the mean reading with the shutter open.

It should be understood that it is only when the condenser discharges are used that such observations are necessary, for the steady currents produce very little disturbing effect on the galvanometer. In the following experiments, the condenser was used, and, with the discharge-tube close up to the slit of the spectrometer, mean disturbances, *i. e.* readings with the shutter closed, were always observed in the intervals between the readings with the shutter open. Later, when the arrangement of the apparatus was altered, these were no longer necessary, and attention was concentrated more on the best means of obtaining a consistent set of readings in which the currents had not varied.

As regards the measurement of the current in the case of these disruptive discharges, it will easily be understood that no practicable method could be found.

When the current rises to such high values for very short intervals of time, the electrometer method is useless, as it gives no indication of the maximum potential difference between the ends of the potentiometer resistance. A ballistic method is also impossible owing to the alternating character of the exciting (primary) current. Since we are only looking for a displacement of energy, it is enough to establish an increase or decrease of the current when certain alterations are made, and to see whether any relative changes of energy in the spectrum have taken place when the current has varied. The method of the rotating mirror described above is unsuitable, owing to the difficulty of observing the length of the somewhat "ghostly" peak which makes its appearance when the disruptive discharge is resorted to.

The mirror was therefore used first of all to establish the fact that when the terminals of the primary current in the transformer were changed, a substantial increase in the discharge took place. The subsidiary discharge-tube was then removed from the circuit and the currents obtained as a result of the various arrangements of the transformer-terminals were merely designated by A, B, and C in ascending order of magnitude.

First are described a series of observations intended to test whether there is any displacement of the energy in the spectrum when the strength of excitation is altered.

Table II. is a specimen of the observations at one pressure. The upper half refers to the total radiation as transmitted by the spectroscop, while the lower represents the radiation

TABLE II.—Energy Displacement.

June 12th, 1912.

	CURRENT A.			CURRENT B.			CURRENT C.					
	Shutter closed.	Shutter open.	Mean defln.	Shutter closed.	Shutter open.	Mean defln.	Shutter closed.	Shutter open.	Mean defln.			
TOTAL VISIBLE RADIATION.	28.1 } 28.1 } 28.1 }	28.22 } 26.55 } 28.12 }	1.72	3.30 } 3.05 } 3.10 }	29.65 } 27.00 } 29.65 }	2.65	31.00 } 30.70 } 30.85 }	30.65 } 27.50 } 30.55 }	3.10			
	28.25 } 28.18 } 28.25 }	28.60 } 27.12 } 28.60 }		1.72	29.61 } 29.50 } 29.65 }		29.75 } 29.40 } 29.69 }	2.32		30.50 } 30.35 } 30.46 }	30.30 } 27.00 } 30.15 }	3.22
	28.90 } 28.88 } 28.95 }	29.15 } 27.67 } 29.15 }			1.82		29.75 } 29.60 } 29.80 }			29.75 } 29.30 } 29.75 }	2.45	
										30.95 } 27.45 } 30.75 }		
	RED LINE λ 6563.				32.80 } 32.55 } 32.55 }	31.82 } 31.45 } 31.92 }	0.42	31.00 } 30.70 } 30.85 }	31.45 } 30.72 } 31.45 }	0.73		
					31.90 } 31.85 } 31.95 }	31.90 } 31.45 } 31.95 }		0.47	31.65 } 31.50 } 31.65 }		31.50 } 30.75 } 31.35 }	0.67
					27.45 } 27.32 } 27.45 }	27.40 } 26.80 } 27.33 }			0.44		32.80 } 32.65 } 32.70 }	
					27.40 } 27.25 } 27.33 }	27.45 } 26.90 } 27.38 }	0.49			32.20 } 32.12 } 32.20 }	32.85 } 32.18 } 32.93 }	
					27.46 } 27.38 } 27.44 }	27.80 } 27.35 } 27.80 }		0.45		33.15 } 32.98 } 33.15 }	33.20 } 32.45 } 33.00 }	0.65

pressure = $\frac{30.8}{8.55} = 3.60$ cm.

Current B $\frac{\text{total radiation}}{H_a} = \frac{2.32}{0.36} = 6.45.$

Current C $\frac{\text{total radiation}}{H_a} = \frac{3.02}{0.52} = 5.21.$

contained in the red line (λ 6563) as recorded when the receiving slit of the thermopile coincided in breadth with the sharp outline of the said line. Each group of three numbers consists of a zero observation at the beginning and end, with the deflexion observation between.

In Table III. are summarized the results of three such sets of observations at different pressures.

TABLE III.

Pressure.	CURRENT B.			CURRENT C.			$\frac{N_C}{N_B}$
	Total radiation.	H_a	$N_B = \frac{\text{Total}}{H_a}$	Total radiation.	H_a	$N_C = \frac{\text{Total}}{H_a}$	
1.86 cm.	3.37	0.53	6.36	4.56	0.75	6.08	0.93
3.60 „	2.32	0.36	6.45	3.02	0.52	5.81	0.90
5.03 „	3.73	0.55	6.80	5.67	0.97	5.85	0.86

In considering this table the only *vertical* columns which should be compared are that containing pressure and that containing the quantity $\frac{N_C}{N_B}$, for the other vertical columns are not “comparable.” [For a rigorous definition of “comparable” spectra see Vegard, *Ann. der Phys.* vol. xxxix. p. 114 (1912).]

The fact that the quantity $\frac{N_C}{N_B}$ is in all cases less than unity indicates a shift of energy of such a kind as to make H_a relatively stronger at higher current-density, and the greater and greater divergence of $\frac{N_C}{N_B}$ from unity as the pressure rises confirms the conclusion.

The quantities N_C and N_B given in the 4th and 7th columns have no value when considered alone. That is to say, the 2nd and 3rd columns are not comparable. This results naturally from the interposition of a prism in order to obtain the radiation from H_a , which operation introduces an unknown factor of loss. It is only when we form the quotient $\frac{N_C}{N_B}$ that the number obtained has significance, and, far from being about $\frac{1}{6}$ of the total visible radiation,

H_α appears from the curves given later to have more nearly $\frac{1}{2}$ the total energy.

So far, no spark-gap had been used in the production of the discharge, and the currents did not vary to any great extent. Also, as was mentioned before, the discharge-tube was close up to the slit, and gave considerable disturbing effects.

It is obvious that if a projecting lens were used to throw an image of the capillary portion of the tube on to the slit, there would be a great gain in accuracy, although some of the energy would be wasted. The conditions which such a projecting lens must fulfil are as follows:—If the object, or that portion of it which it is desired to observe, is of the same size as the slit, the distance of object from lens must be equal to the distance of lens from slit, *i. e.* the ratio of aperture to focal length must be twice as great in the case of the projecting lens as in the case of the collimator lens. It is also highly essential that the lens be a good achromatic one, in order that no part of the spectrum shall be favoured in the energy measurements. If the ratio of aperture to focal length be not twice as great for the projecting lens as for the collimating lens, some of the surface of the latter will not be traversed by light, and a larger lens of the same focal length is what is desired.

Now it is difficult to find good achromatic lenses of the aperture ratio desired (about $\frac{1}{4}$), especially as a large linear aperture is desirable on account of the necessity for removing the oscillatory circuit as far as possible from the galvanometer.

At the beginning of August 1912, an achromatic lens of $3\frac{3}{4}$ inches linear aperture and about $\frac{1}{7}$ -aperture ratio was, through the kindness of Mr. Hincks, borrowed from the Observatory at Cambridge, and the curves of distribution of energy given later owe their existence entirely to this valuable addition to the apparatus. A plan of the new arrangement of the whole apparatus is given in fig. 11, which is drawn roughly to scale. The table to the left has the gas-generator, vacuum-pump, &c., while the transformer is at least twice as far to the left of the galvanometer as the discharge-tube D.

Under the new conditions, even when a large spark-gap was placed in the circuit, there were no disturbing deflexions greater than 0.05 cm. In order to find out what sort of constancy was to be expected in the readings, a long series of readings at various intervals of time was taken.

The result of these was that the deflexions obtained immediately after an interval of quiescence were always greater

than those obtained in rapid succession or the final deflexion obtained by holding on the discharge for a period, say, of ten seconds.

There are two courses open : either the readings must be obtained in rapid succession or an interval of at least 2 minutes must be allowed between consecutive observations.

Owing to the great heating of the tube if readings were taken rapidly, and the necessity for waiting at times between readings, to set the spectroscope, the latter of the two alternatives was chosen.

We next give some observations on the shift of energy in the spectrum of hydrogen, making use this time of the two lines H_α and H_β instead of H_α and the whole energy.

Curve 6 (Pl. XIV.) shows the results at a pressure of 2.9 cm. of mercury, and Curve 7 those at 6.8 cm. pressure.

We may summarize them as follows :—

Curve 6 :—

$$\text{Pressure} = 2.9 \text{ cm.} \left\{ \begin{array}{l} (a) \text{ Weak Current, } \frac{H_\beta}{H_\alpha} = \frac{0.61}{3.37} = 0.181 \\ (b) \text{ Strong Current, } \frac{H_\beta}{H_\alpha} = \frac{1.14}{7.0} = 0.163 \end{array} \right.$$

$$\frac{(a)}{(b)} = 1.11$$

Curve 7 :—

$$\text{Pressure} = 6.8 \text{ cm.} \left\{ \begin{array}{l} (a) \text{ Weak Current, } \frac{H_\beta}{H_\alpha} = \frac{0.7}{2.65} = 0.264 \\ (b) \text{ Strong Current, } \frac{H_\beta}{H_\alpha} = \frac{1.38}{6.68} = 0.206 \end{array} \right.$$

$$\frac{(a)}{(b)} = 1.28$$

On plotting the results, together with those of Table III., and using respectively

$$\frac{\frac{H_\beta}{H_\alpha} \text{ (weak current)}}{\frac{H_\beta}{H_\alpha} \text{ (strong current)}} \quad \text{and} \quad \frac{\frac{H \text{ whole}}{H_\alpha} \text{ (weak current)}}{\frac{H \text{ whole}}{H_\alpha} \text{ (strong current)}}$$

as variables against pressure, we get the interesting results shown in Curve 8. At all pressures there is evidence of a shift of energy, since the variable differs from unity. The fact that the quantities appear to form a straight line in the case of $\frac{H \text{ whole}}{H_\alpha}$ can scarcely be of much value, but the

increase of the variable with increasing pressure points to some regularity and leaves little doubt as to the existence of the phenomenon.

It is not to be expected that the ratio of H_α to the whole energy would vary in exactly the same way as the ratio of H_α to H_β , but H_α being by far the most prominent feature of the spectrum we should expect to find the variation in the same sense in both cases.

The same phenomenon—*i. e.* shift of energy towards *longer* wave-lengths with increased excitation—has been observed by Vaillant (*Comptes Rendus*, 1906, p. 81) in the case of the mercury arc. In some respects the discharge from a large condenser at comparatively high pressures resembles the mercury arc.

C. *The Continuous Distribution of Energy in the Spectrum.*

This was investigated by taking a long series of readings at appropriate intervals of time. Curves 9, 10, 11, 12 (A and B) (Pl. XIV.) contain observations on the spectrum of hydrogen at three different pressures, and on that of air.

Table IV., representing Curve 10, is given as an example. Curve 9 was really only obtained as a test, and as only one reading was taken for each point the values are but very approximate. The general form of the curve is apparent, but even an inspection of the spectrum with an eyepiece shows that the peak representing H_β is too sharp. A perfectly monochromatic line gives two intersecting straight lines, such as can be seen to a fair degree of perfection in the case of H_α , even at higher pressures.

In order to obtain enough energy a rather wide slit has to be employed, giving a considerable breadth to the trace of a monochromatic line on the curve. The readings for Curves 10 and 11 were made more systematically than those for Curve 9. They were always taken in pairs belonging to the same spectroscope setting, thus affording some sort of check. Further, a single progression from one end of the spectrum to the other was not allowed to suffice, and a return was made to some of the more important points, thus avoiding any errors due to the possible slow change in the conditions of the discharge. The reading marked "(a)" in Table IV. is a test for disturbing effects with shutter closed. Both of these curves show a continuous spectrum of some intensity, and it appears that a smooth curve could be drawn along the groundwork of the spectrum, thus suggesting strongly the continuous spectrum given by an ordinary heated body.

TABLE IV.—Hydrogen Spectrum.

Aug. 15th, 1912, 7 P.M.

Spectroscope Reading.	Deflexions in pairs.	Means of pairs.	Spectroscope Reading.	Deflexions in pairs.	Means of pairs.
(a)	-0.05 -0.03	-0.04	$\overset{\circ}{59} \overset{\prime}{5} \overset{\prime\prime}{0}$	2.74 2.89	2.81
$\overset{\circ}{60} \overset{\prime}{8} \overset{\prime\prime}{0}$	0.22	0.21	58 25 0	0.91 0.95	0.93
60 0 0	0.21 0.60	0.51	59 2 0	1.10 1.05	1.07
59 52 0	0.43 0.65	0.69	58 21 0	0.90 0.96	0.93
59 44 0	0.74 0.80	0.85	58 58 0	0.34 0.44	0.39
59 36 0	0.90 0.88	0.89	58 23 0	0.90 0.97	0.93
59 28 0	0.90 0.87	0.89	58 48 0	0.46 0.29	0.37
59 22 0	0.88 0.78	0.87	58 38 0	0.52 0.32	0.42
59 18 0	0.76 0.80	0.77	58 28 0	0.71 0.80	0.75
59 14 0	0.97 2.85	0.88	58 18 0	0.65 0.56	0.60
59 10 0	2.57 4.72	2.71	58 8 0	0.45 0.26	0.36
59 12 0	5.07 3.98	4.89	58 0 0	0.36 0.44	
59 10 0	4.05 4.95	4.01	57 56 0	0.33 0.39	0.38
59 12 0	5.00 4.30	4.97	57 53 0	0.48 0.50	0.43
59 10 0	3.96 4.71	4.13	57 47 0	0.45 0.24	0.47
59 11 0	4.80 4.87	4.75	57 35 0	0.27 0.40	0.25
59 8 0	4.77 4.46	4.82	57 25 0	0.30 0.17	0.25
59 11 0	4.70 4.65	4.58	57 15 0	0.15 0.15	0.16
58 23 0	4.82 0.98	4.73	15 11 0	0.12 4.66	0.13
	0.92	0.95		4.43	4.54

The following more important readings have more than one pair:—

$\overset{\circ}{59} \overset{\prime}{10} \overset{\prime\prime}{0}$	4.89	} 4.87	$\overset{\circ}{58} \overset{\prime}{23} \overset{\prime\prime}{0}$	0.95	} 0.94
	4.97			0.93	
	4.75				
59 11 0	4.82	} 4.70			
	4.73				
	4.54				

pressure = 2.92 cm.

During the observations represented by Curve 10 some water was noticed in the discharge-tube. It appears that the influence of the discharge on the brass walls of the hollow electrodes is to make them become porous in time. The effect of the water seems only to have been to increase somewhat the intensity of the continuous spectrum underlying the peaked curve. Comparing this curve (10) with (11) the interesting fact comes out that there is a very marked shift of the energy towards the longer wave-lengths. Not only is the ratio of H_{β} to H_{α} much smaller at the higher pressure, but the still shorter wave-lengths have practically disappeared. Curve 10 seems to suggest that the peaks could be joined by a smooth curve, probably an exponential one. But the values are scarcely accurate enough to fall in with such a stringent test. It is true that the two chief peaks in the curve represent the means of many readings, but even then they are liable to errors of a few per cent.

The curves for air (12 A and B) show clearly that the gas was contaminated with hydrogen, doubtless occluded and re-emitted by the electrodes. The rest of the spectrum is made up of lines too close to be resolved by the instrument, and exhibits a very great increase in intensity in the red region when the pressure is raised. This increase may not be so abnormal as at first sight appears, for at the higher pressure the proportional amount of hydrogen present must have been much smaller, and if the blue region of the spectrum be considered, the proportional rise in the red is not much greater than in the other part. There is, of course, the bare possibility that some of the energy in the red end of the spectrum may be due to the heating of the capillary portion of the tube to redness, but several distinct pieces of evidence can be found to negative this supposition. In the first place, there is no reason why the same large maximum should not have been observed in the spectra of hydrogen. Secondly, accompanying such a large increase in magnitude of the maximum there must be in the case of a pure temperature radiation a very marked shift in the position of this maximum.

Against this we may set the fact that the opacity of the glass apparatus may have been responsible for the downward-sloping portions on the right of both curves, so that the maxima of both would have been hidden.

Theoretical.

The subject of the radiation from gases in discharge-tubes is a difficult one to approach theoretically, because, in the

absence of *any particulars*, it is impossible to institute a *general* investigation. Many are the theories, no doubt, which different physicists conceive when they think of the luminosity of gases in discharge-tubes. One view is that it is simply the energy of a collision between a corpuscle and a molecule which gives rise to radiation. Berndt (*Ann. der Phys.* vol. xii. p. 1101, 1903) has developed a particular theory a little more in detail. He supposes that the fraction of the energy of a moving corpuscle converted into radiant energy is proportional to \sqrt{v} , v being its velocity. The result of his calculation is that we should have

$$\frac{\text{Intensity}}{\text{current}} \times \left(\frac{\text{potential gradient}}{\text{pressure}} \right)^{\frac{3}{2}} \propto \text{pressure.}$$

Curves obtained by plotting this magnitude against p were linear at low pressure in the cases of H_{α} and the nitrogen bands λ_{5214} and λ_{6069} , the curves passing through the origin of coordinates, but bending away later.

Another view is that the process of ionization is always accompanied by radiation, and that a certain amount of energy is liberated each time an ion is formed, or a recombination takes place. There seems much evidence confirmatory of this theory. In the first place, as Pflüger and Ladenburg have shown, absorption of the light emitted by gases depends on the absorbing gas being in the same electrical state, *i.e.* it is only when a current is passing through the gas that its atoms are possessed of the natural frequency which gives rise to its absorbing power. This is very nearly equivalent to saying that a necessary concomitant of radiation is ionization. Recently (*Phil. Mag.* 1912) Andrade has shown that the radiation from a Bunsen flame rendered luminous by metallic vapour is proportional to its conductivity when the saturation-current is employed, which fact is in direct agreement with the theory in question. Radiation from such a flame is subject to the same laws as to absorption as gases in discharge-tubes, and there is no reason to suppose that the centres of emission are radically different in the two cases.

Ladenburg, in a recent paper (*Ann. der Phys.* May 1912), has shown the existence of "anomalous" dispersion and magnetic rotation in hydrogen when carrying a discharge, and he has come to the conclusion that *all* the phenomena in luminous hydrogen can be explained by supposing a certain number N of singular particles to exist in every c.c. of the medium, just as in the Drude theory of dispersion. In

order to account for the proportionality between radiation and current-density we have only to suppose that the number of ions formed per c.c. per sec. is proportional to the current, a supposition which meets with no difficulty in the theory of the passage of electricity through gases. The fact that absorption can be observed in a straight tube with no apparent differences in intensity can be explained by supposing that there are places where most of the ions have come from elsewhere, moving with high velocities, and thus maintaining the necessary current-density with only a few ions per c.c. Or if the continuous spectrum mentioned in this paper above came from different centres of emission from the bright lines this would account for the absorption observed.

SUMMARY AND CONCLUSION.

The results of the present investigations may be summarized as follows :—

(1) If the current in a discharge-tube be small, the radiation from it is proportional to the current-density, both for the whole spectrum and for any portion of it.

(2) In heavy discharges such as that produced by a large condenser in parallel with the discharge-tube, there is strong evidence that the energy shifts towards the longer wave-lengths when the current-density increases. Whether the energy of any portion of the spectrum increases at a rate greater or smaller than the current has not been determined, owing to the difficulties in the way of measuring these currents.

(3) When the pressure at which a condensed discharge is sent through the tube is increased, the energy shifts towards the longer wave-lengths. A continuous spectrum makes its appearance in these discharges, and becomes more marked, the higher the pressure.

The above investigations make no claim to completeness, and confirmation of them is eminently desirable. The writer hopes to continue the research and to extend it to other gases. To Prof. Sir Joseph Thomson, for suggesting the research, and for much interest and advice, he owes his best thanks. Prof. Paschen of Tübingen has helped the work on much by his kindness in demonstrating the principles of his galvanometer and in providing one of these out of his own laboratory.

LXX. *Resonance Spectra of Iodine under High Dispersion.*
 By R. W. WOOD, *Professor of Experimental Physics,*
Johns Hopkins University, and Adams Research Fellow of
Columbia University *.

[Plates XV. & XVI.]

IN my last communication on the resonance spectra of iodine (Phil. Mag. Oct. 1912, p. 673) I showed that the green line of the mercury-vapour lamp had a width sufficient to enable it to cover from two to seven of the fine absorption lines of iodine. In the case of the Cooper-Hewitt glass lamp the green Hg line was so narrow that only two absorption lines were excited, while in the case of the quartz lamp, running at a high temperature, the line was so broadened that seven absorption lines were covered. In the latter case the resonance spectrum consisted of groups of lines occurring at regular intervals along the spectrum, and to this type of stimulation I gave the name "multiplex excitation." I predicted at this time that the appearances of the groups of lines could be profoundly modified by running the quartz lamp under different conditions as to temperature and voltage drop across the terminals, as in this way the width of the exciting line could be varied, and the number of absorption lines excited easily controlled. The adoption of this plan has thrown much new light upon the genesis of resonance spectra, and further improvements in the methods of utilizing the exciting light have made it possible to photograph the resonance spectra in the fourth order spectrum of the large plane grating which I use in the 42-foot spectrograph, though with a lens of shorter focus (2 metres) and with an exposure of only 24 hours. When it is remembered that in the first study of the iodine fluorescence an exposure of 24 hours was necessary to secure a satisfactory photograph with a Hilger one-prism spectrograph, the immense gain in efficiency is apparent. I can now secure good photographs of the resonance spectrum in the first order spectrum of the grating in 30 minutes.

The work of the past year has furnished some very definite problems in molecular mechanics for the theoretical physicists to solve, and I feel that, for the first time, I am now able to furnish some very exact knowledge of the nature of these remarkable spectra, which it is most important to account for by theory.

The methods which I have adopted in the present work may be outlined briefly as follows :—

* Communicated by the Author.

1. *Control of the excitation.*—The iodine vapour was excited by the light of a quartz mercury-vapour lamp operating with various resistances so as to show a potential drop across the terminals varying from 25 volts to 165 volts. The tendency of the lamp to go out when running with a large resistance in circuit with it was overcome by including in the circuit a large amount of self-induction, consisting of two coils of very heavily insulated wire with laminated cores, for which I am indebted to Mr. Cooper-Hewitt. A voltmeter and ammeter was used in each case to determine the watt consumption of the lamp, and the appearance of the green exciting line in coincidence with the absorption spectrum of iodine was observed during each exposure, in the fourth order spectrum of a 6-inch grating with a lens of 3 metres focus. In addition to this, a valuable series of photographs of the green line in coincidence with the absorption spectrum was made for me by Dr. J. A. Anderson, with the large spectrograph of the Mt. Wilson Solar Observatory. This instrument has a focal length of 75 feet and is furnished with a Michelson grating. It appears to have about the same resolving power as my East Hampton spectrograph, though its greater focal length enables it to yield photographs of much more satisfactory appearance, the definition in the case of my instrument being marred somewhat by the grain of the plate.

The method of controlling the excitation which I adopted necessitates the use of two powerful spectrographs, one for photographing the resonance spectrum, the other for studying the appearance of the green exciting line during the exposure and determining which of the iodine absorption lines are excited by it.

I have also used a very large and powerful Cooper-Hewitt glass lamp, the tube having an internal diameter of 5 cm., and carrying a current which can be varied from three to

Fig. 1.

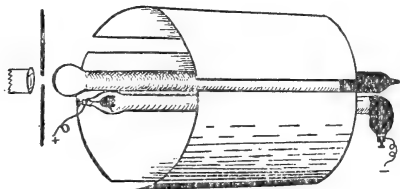

fifteen amperes. A novel method of illumination was used in the case of this lamp, which appears to be the most efficient found up to the present time. It is illustrated by fig. 1. Three enormous cylindrical reflectors were made

from the curved glass plates used for the corners of shop windows. These were furnished silvered by a mirror-glass company at a very small cost, and when mounted as shown formed a nearly complete cylindrical reflecting shell over half a metre in diameter and in length. The exhausted tube containing the iodine and the large Cooper-Hewitt lamp were mounted side by side along the axis of the reflecting cylinder, the whole arrangement furnishing a sort of "light furnace," in which the iodine vapour glowed with great brilliancy. The supports of the large mirrors and the parallel tubes are omitted in the diagram to avoid confusion.

Further control of the method of excitation was obtained by passing the light of the mercury arc through a large glass bulb 40 cm. in diameter, exhausted save for enough bromine vapour to give the transmitted light a good yellow colour. The bromine vapour has certain lines in coincidence with iodine absorption lines, and by its use as a ray-filter we may remove certain frequencies from the green mercury line and in consequence throw certain iodine lines out of action.

2. Study of the relation between resonance lines (*i. e.* bright lines emitted by the iodine as a result of stimulation by more or less monochromatic light) and the complicated absorption spectrum, which as I showed in my last paper contains about 35,000 lines between the blue and the red, over 100 falling within a region no wider than the distance between the yellow sodium lines. In all of my earlier work I have been of the opinion that each bright resonance line was in coincidence with some one of the numerous dark absorption lines, but I now find that this is not the case. The direct method of solving this question would be to photograph the two spectra in coincidence with a resolving power sufficient to completely resolve the absorption spectrum. This can be accomplished only by a spectrograph comparable to the one on Mt. Wilson, or my own at East Hampton, and to photograph the resonance spectrum under these conditions is almost out of the question. There is, however, another way in which we may obtain an answer to the question; we may photograph the resonance spectrum after the light has been passed through a second tube or bulb containing iodine vapour, and see whether the numerous lines forming the resonance groups are all weakened to the same degree, as would be the case if they were all in coincidence with absorption lines of the same intensity.

This is an important point, not only from a theoretical but from an experimental standpoint, for in the case of the

excitation of the fluorescence in the long tube by the Cooper-Hewitt lamp, the light from the more remote portions of the tube is obliged to traverse a considerable thickness of iodine vapour, and the intensity distribution amongst the lines of the various groups may be modified by absorption. It was found, as a matter of fact, that this was the case, which at once explained why the resonance spectrum excited by the Cooper-Hewitt lamp appeared to be quite different from that excited by a quartz lamp running with a large resistance in circuit with it.

In the case of excitation by the quartz lamp, the image of which was focussed along the axis of the iodine tube by means of a large condenser, the emitted light had but a short path to traverse in iodine vapour; consequently absorption played a lesser rôle, but to still further remove its influence a portion of the tube was cooled with ice and salt, which reduced the density of the iodine vapour about tenfold. A new phenomenon was at once discovered, namely, that under these conditions the band spectrum, which, as I have shown, is strongly developed if the iodine is in helium at a pressure of a few millimetres, is quite strongly developed even when the iodine is in a high vacuum. This matter will be more fully discussed later on.

3. *Photography of the Spectra.*—The spectra excited by the green and the two yellow lines of mercury have been photographed both together and separately in the first order spectrum of the large grating, by the use of ray filters of neodmium or cosine interposed between the mercury lamp and the iodine tube, and the more interesting groups of resonance lines have been taken in the fourth order spectrum of the same grating, which showed that they were more complicated than was at first supposed, and explained the peculiar behaviour of some of the lines when the exciting lamp was operated under different conditions.

It is quite impossible to give reproductions of the photographs which bring out all of the interesting points owing to the enormous difference in the intensities of the lines forming the groups. I have given, however, on Plate XV. fig. 1 a reproduction of the complete resonance spectrum excited by the large Cooper-Hewitt lamp, with the wave-length of each line recorded on a strip below. It appears to me that this is preferable to a table of wave-lengths, for the reason that there is no question in this case about establishing the identity of any given line. This spectrum is emitted by the iodine vapour when it is illuminated by the total radiation of the mercury lamp, the green and the two yellow lines

being, however, the only ones involved in the excitation. Immediately below (Pl. XV. fig. 2) is the spectrum excited by the light of the quartz lamp operating with a potential drop of 140 volts across the terminals, in which case we have the mercury lines so broadened that they cover a number of iodine absorption lines. The superposed spectrum of short lines is that of neon. For the purpose of comparison I have mounted the spectrum obtained with the Cooper-Hewitt excitation immediately below, and in coincidence with it. Both of these photographs were made with a large plane grating in the first order spectrum and are therefore very nearly normal.

The most interesting part of the spectrum, and the one to which the most study has been given, is the region between the green and the yellow mercury lines. In this region ordinary isochromatic plates (Cramer) are extremely sensitive, fully eight times as sensitive as spectrum plates, consequently the time of exposure is proportionally reduced. Some of the plates were given an exposure of only ten or fifteen minutes, consequently many different observations could be made in a single day. On the other hand, when using spectrum plates and the bromine filter the exposures were often of five days, duration, the quartz lamp running day and night without attention.

We will begin with a discussion of the spectra excited by the green line with the lamp running under varying conditions. It will be necessary first to give a general statement of the phenomena and adopt a nomenclature, as the subject is a little involved. In the first place it is of the utmost importance to ascertain what occurs in the immediate vicinity of the exciting line. As I have shown in previous papers, the vapour always emits a line the wave-length of which is identical with that of the exciting light. This line we will term for brevity the R.R. line (resonance radiation). If we carefully screen from the slit of the spectroscope all light except that which comes from the iodine vapour, which we can do by means of a small diaphragm placed between the slit and the rounded end of the iodine tube, we find that the R.R. line is accompanied by companion lines which form a group very similar in appearance to the other groups which appear at intervals along the spectrum. Now the actual width of the group of seven absorption lines which are covered by the green line of mercury is only about $1/30$ of the width of the group of lines accompanying the R.R. line.

On Plate XVI. fig. 1 we have a photograph of the iodine

absorption spectrum* with a diagram of a portion of the group around the R.R. line immediately above it. The seven absorption lines covered by the green Hg line are indicated by the arrows. The upper diagram has been shifted to the right in order to show as much of the group as possible. To bring the two into coincidence the line marked Hg should be brought over the seven absorption lines.

The circumstance that the group of lines at the R.R. line is many times wider than the group of seven absorption lines is a very important point, in fact the most important of all, for it shows us that each one of the absorption lines must be responsible for more than a single line in each group.

The R.R. lines of the seven absorption lines would all appear superposed with the resolving power employed in observations of the resonance spectrum, and the appearance of a group of lines at this point shows that each absorption line gives us a R.R. line with one or more close companions. The R.R. lines are of course superposed in the photographs, but the companions are far enough removed to be resolved, and taken collectively form the group. As the potential drop of the lamp is increased the companion lines increase in number, as more and more absorption lines are covered by the green line.

This will be more readily understood perhaps by reference to fig. 2, which is a chart of the groups of the iodine resonance spectra excited by the quartz arc under different conditions. With 140 volts potential difference we find three very similar groups of lines at wave-lengths 5461, 5525, and 5657.1. A characteristic faint triplet to the left, a strong triplet in the middle, with two or three faint lines to the right. Now the general law of resonance spectra has been found to be that the excitation of a single absorption line causes the emission of a spectrum of single (usually) lines, placed at sensibly equal intervals along a normal spectrum, certain lines of the series being often absent. Now if the groups of lines, which appear when a very close group of absorption lines are excited (multiplex excitation), were formed by the superposition of a number of series of equidistant lines, all originating at the same point (so far as the resolving power employed is concerned), they would be identical in appearance, but their widths would increase

* This photograph was made by Mr. Ellerman of the Mt. Wilson Observatory. It was taken on a process plate of a very fine grain and bears enlargement much better than my own photographs.

in the proportion 0, 1, 2, 3, &c. The width of the first group, made up of the superposed R.R. lines, would be equal to the width of the group of absorption lines, and would be

Fig. 2.

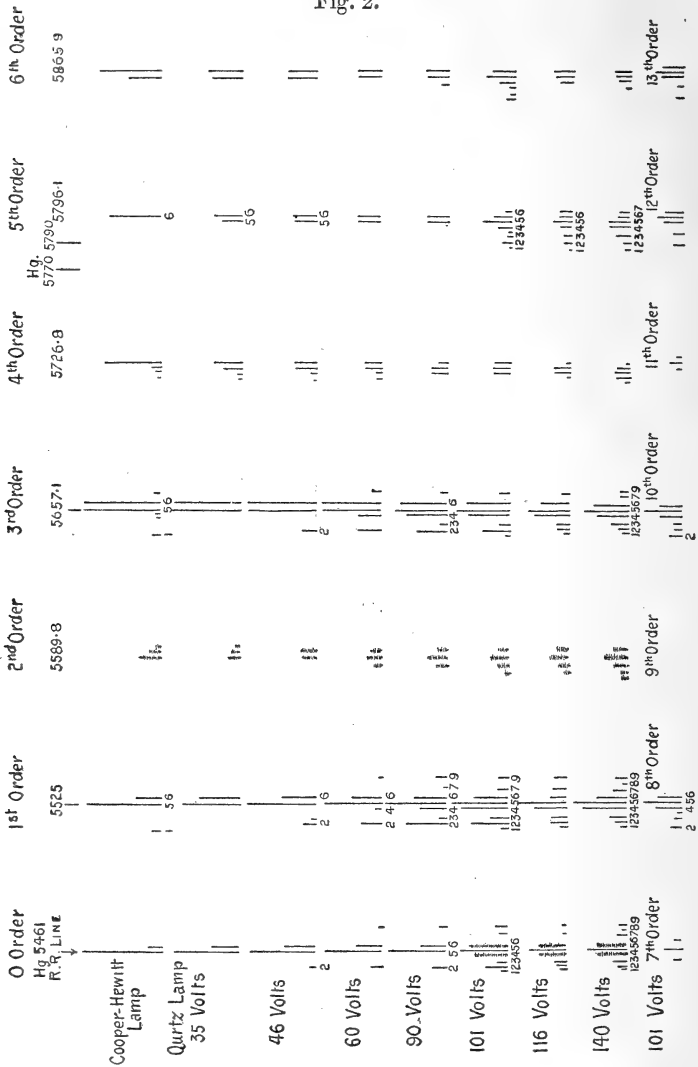

sensibly zero with the dispersive power employed. The circumstance that the characteristic group appears around the exciting g, and that the widths of the groups are

sensibly the same, instead of increasing in the proportion 1, 2, 3, &c., makes it appear probable that they originate in the following way. Each absorption line gives rise to a series of equidistant lines which are superposed, and which form what we might term the cores of the groups. These lines are accompanied by companion lines which fall sometimes to the right and sometimes to the left of the principal lines. The position of a companion line depends upon which one of the seven absorption lines is excited, but for any given absorption line the position of the companion line and its distance from the main line (core of the group) is the same, both for the R.R. line and the lines of the equidistant series. A very careful study of some thirty photographs, taken under different conditions, has convinced me that the groups arise in the manner outlined. This, of course, holds only for groups of identical appearance.

As it will be necessary to discuss some of the other groups of lines and compare them with the three enumerated above, it will be well to adopt an easy method of identification. As they appear to the right and left of the exciting line at regular intervals along the spectrum, we may for convenience adopt the nomenclature used in the case of grating spectra, and speak of them as groups of the first, second, third (&c.) order. The R.R. line would be of order 0, the groups on the short wave-length side -1 , -2 , &c., and on the long wave-length side 1, 2, 3, 4, &c. The characteristic groups which have been under discussion, and which are precisely similar, are of orders 0, 1, and 3. They are found nowhere else, though the fifth order group, which covers the yellow mercury line of longer wave-length, differs from these groups only in that the centre is formed of a doublet instead of a triplet. This group can be seen only on photographs of the resonance spectrum excited by the green line alone, *i. e.*, with the yellow light removed from the exciting rays by means of a neodmium ray filter. It is well shown on fig. 4, Pl. XV., the position of the yellow Hg lines being indicated by arrows.

The formation of groups of lines in the manner described appears to be quite characteristic, for the same thing occurs in the case of the excitation by the two yellow mercury lines, as is shown by fig. 5, Pl. XV. In this case the green line has been removed from the exciting beam by means of an eosine filter. In this case we have the group of order 1, and groups of order -1 and -2 , to the right and left of the groups which fall in coincidence with the exciting lines (0 order).

On looking over my work on the resonance spectra of

sodium I find numerous cases analogous to the ones enumerated, although the groups are not as complicated as in the case of iodine vapour. The excitation of sodium vapour by the 5086 line of the cadmium silica lamp gives rise to a series of doublets, the components being about 6 Ångström units apart. One of these is found at the point of excitation (5086); in other words, we have the R.R. line (5086) with a strong companion 6 Å. U. to the right of it, and the doublet thus formed is repeated at regular intervals along the spectrum.

We will now take up the study of the groups excited by the green mercury line. The problem is to ascertain the corresponding lines of the various groups and to determine which of the iodine absorption lines are associated with them. This was accomplished by operating the quartz arc under different conditions, as I have said before. On Pl. XVI. figs. 5, 6, 7, and 8, we have photographs of the iodine absorption spectrum in coincidence with the green mercury line, with voltage drops across the terminals of the exciting lamp of 45, 60, 110, and 90 volts. These were made for me by Dr. Anderson at the Mt. Wilson Observatory. I have numbered the iodine absorption lines on fig. 5 as in my previous paper. Another method of studying the relation between the exciting line and the absorption lines is to photograph the emission line of the quartz arc alone and after the light has traversed a bulb of iodine vapour. Fig. 4 shows (upper spectrum) the green line with a voltage drop of 45, and (lower spectrum) the same line after suffering absorption by iodine vapour. This is of interest as showing how an exciting line may have its character altered by a ray-filter such as bromine. In fig. 6 the green line below the absorption spectrum has been passed through iodine vapour.

In the first place we observe (fig. 5) that there is a trace of reversal even at this low voltage, and that the centre of the line falls between absorption lines 3 and 4, lying rather nearer the former. During the present summer I have photographed the green line of the Cooper-Hewitt glass lamp in coincidence with the iodine absorption with my 42-foot East Hampton spectrograph which has been put underground and will be described elsewhere (*Astrophysical Journal*). The line in this case shows no trace of reversal and is almost in coincidence with absorption line 3. I doubt if, in this case, line 4 receives any excitation. The photographs reproduced are but a small part of the total number taken.

The groups excited by the 5461 line are recorded in fig. 2 (p. 834) diagrammatically, the distances between the groups being reduced somewhat to save space. The spectrum, excited by the lamp operating at 140 volts, is identical with the photograph reproduced on Pl. XV. fig. 4. The exact wave-lengths of the lines will be given in a table presently.

I have numbered the lines in the characteristic groups for the purpose of identification, and the chart shows the groups as they appear in the photographs made in the first order spectrum of the large grating. The "intensities" are represented by the lengths of the lines. Their appearance under the higher resolving power of the fourth order will be discussed later on.

We will begin by comparing the resonance spectrum excited by the Cooper-Hewitt lamp, and the quartz lamp operating at 35 volts, which we should expect to be identical, for the vapour density in the lamps is about the same. This is far from being the case, however. The first order group in the case of the C.-H. lamp is made up of the "core" line 5525 with a fainter companion to the right, and a still fainter one far off to the left, which I have identified with line 1 of the complete group as it appears in the spectrum excited by the lamp at 140 volts. In the case of the quartz lamp at 35 volts the group consists of two lines of nearly equal intensity, with no trace of line 1. This puzzled me for a long time, but I believe that I have found the explanation. In the case of excitation by the C.-H. lamp, the light is emitted by a long column of iodine vapour, and is, in consequence, subjected to the absorbing power of the vapour. Now control experiments showed that the right-hand member of this doublet was much more strongly absorbed by iodine vapour than the left-hand member. The experiment was made in the following way. An iodine tube, half a metre long, was mounted in front of the slit of the spectroscope with its axis parallel to the axis of the collimator in the usual manner. The image of the quartz mercury arc was focussed first at the end of the tube nearest the slit, and then at the remote end. In the latter case the light from the luminous vapour was obliged to traverse a considerable thickness of iodine vapour of the same density as the radiating vapour. The two photographs are reproduced on Pl. XV. fig. 6, the lower spectrum being made with iodine absorption, the upper without. All other conditions were the same, yet we find that only the left-hand member of the strong middle group of lines in the first order group remains, while the

fainter companion lines are scarcely reduced in intensity at all. This shows us that the resonance lines do not all coincide with absorption lines, or at least that their intensities are not proportional. It also explains the comparative weakness of line 6 of the first order group in the case of stimulation by the Cooper-Hewitt lamp, for in this case we have the factor of absorption in operation on account of the long tube used in the experiment. The difference in the appearance of the 4th and 5th order groups in the two cases cannot be explained in this way, however, for there appears to be no selective absorption of the lines of these groups, as is shown by the photographs. We are therefore forced to the conclusion that the stimulation is not the same in the two cases, and I am of the opinion that in the case of the quartz lamp at 35 volts absorption line 4 is excited to some extent, while in the case of the Cooper-Hewitt lamp the excitation is confined to line 3. This is confirmed by the photographs which I have made of the green line of the two lamps during the past summer. It should be observed also that in the case of the Cooper-Hewitt excitation companion line No. 1 appears in the first and third order groups. In the case of the quartz lamp, this line does not appear until the potential at which the lamp is operated is increased to 100 volts or over. From observations of many photographs I am inclined to refer this line to the stimulation of an absorption line marked 0 on the photograph (Pl. XVI, fig. 5) which is in coincidence with the component of the mercury line which has the shortest wave-length, and which is well shown in fig. 6. This component is more conspicuous in the light of the C.-H. lamp than in the case of the quartz one.

If the potential of the quartz arc is raised to 46 volts the green line broadens and completely covers absorption line 3, and nearly covers line 4, stimulating it on its edge of shorter wave-length so to speak. It has not yet been ascertained whether the resonance spectrum varies according to whether the exciting line has exactly the same frequency as that of the absorption line, or one slightly different, that is strikes the absorption line on one edge only. This is an extremely important point, and I hope eventually to find some way of controlling matters so that the question can be answered. For the present, however, I am obliged to assume that it makes no difference.

The strong stimulation of absorption line 4 appears to give rise to the companion line No. 2 of the groups. With 60 volts potential difference, line 4 makes its appearance in the

groups, and since fig. 6 of Pl. XVI. shows us that now absorption line No. 2 is excited by the further broadening of the green line, we may regard companion line 4 as due to this absorption line. At 90 volts potential we have absorption line No. 5 picked up by the exciting radiation, and companion line No. 9 appears. It is extremely difficult to make out which lines are associated in this way, and I have spent many hours in examining and comparing the photographs. Certain points which I could not explain made it seem imperative to obtain photographs of the groups of resonance lines under the highest dispersion possible, and I accordingly shifted to the fourth order spectrum of the large grating, and secured a series of excellent photographs of the 1st and 3rd order groups, with the quartz arc running with various potential drops, and with the Cooper-Hewitt lamp. Enlargements of the 1st order group are reproduced on Pl. XV. fig. 7. The most interesting point brought out was that line No. 4 of the group was a close doublet, and that the component of longer wave-length disappeared if the exciting light was filtered through bromine vapour. The bromine filtration of the exciting light also causes the disappearance of line No. 3 from the resonance group, as I showed in the earlier paper. Owing to the improved definition shown by the 40-foot spectrograph since its burial, I was enabled to get a more satisfactory photograph of the bromine and iodine absorption spectra in coincidence than the one obtained last summer. It is reproduced on Pl. XVI. fig. 3, the group of seven iodine lines with which we are concerned being indicated by the arrows. The bromine vapour removes from the green mercury line those frequencies which are capable of stimulating the iodine lines 3, 6, and 7, the removal being most complete in the case of line 3, for which the coincidence is absolute. The photographs taken with high dispersion show that line 5 of the resonance group, which I have called the core line, becomes double and finally triple as the potential of the exciting arc is increased. On the theory of the formation of the groups which I have suggested, this would mean that the core lines corresponding to the different absorption lines are not in exact coincidence, as was at first supposed. I have given in fig. 3 a diagram of the 1st order group as obtained with high dispersion and with the exciting lamp operating at different potentials, and also a diagram which represents, as nearly as I am able to say at the present time, the decomposition of the group into its constituents. The number of the iodine absorption line which

forms the element of the group is given on the right, thus absorption line No. 3 gives us the core line No. 5 and the companion line No. 6.

Fig. 3.

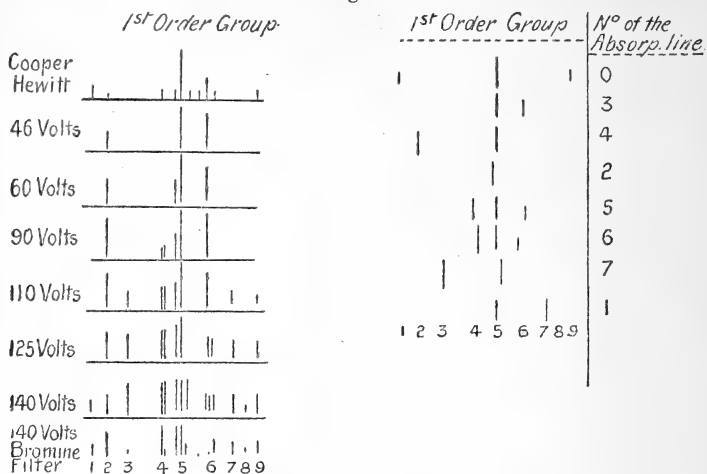

In the case of the Cooper-Hewitt excitation there are a number of faint companion lines which do not appear in any of the other cases, at least with the times of exposure given. This may result from the circumstance that the stronger lines are more weakened by absorption, which plays a prominent part in this type of excitation. With the quartz arc at 46 volts we have the core line 5, and the companions 2 and 6. At 60 volts a companion appears to the left of the core line. I think that this results from the stimulation of absorption line No. 2, but am not quite sure. At 90 volts line 4, a close doublet, first appears. It is quite certain that this doublet results from the stimulation of *two* iodine absorption lines, since if the exciting light is filtered through bromine, the right-hand component of the doublet di-appears, consequently the left-hand component must be excited by an iodine absorption line which is not in coincidence with a bromine line, and which is first covered by the mercury line when the lamp is at 90 volts. This seems to be absorption line No. 5, while the other component, which is removed by filtration of the exciting light through bromine, is probably due to absorption line 6. In the third order group this doublet appears in the same place, but with its right-hand component of about three times the intensity of the left: bromine filtration of the exciting light makes the intensities of the

two components of the doublet about the same, which is what we should expect.

Line No. 3 first appears when the voltage of the lamp is 110, when it is much fainter than line 2. At 125 volts lines 2 and 3 have the same intensity, while at 140 volts 3 is much stronger than 2. Line 3 is removed by bromine filtration of the exciting light, and I believe that it is a companion line due to the stimulation of absorption line 7, the core line associated with it lying a little to the right of the core line excited by absorption lines 3 and 4.

The difficulty in interpreting the results obtained is due to the fact that the mercury line widens both to the right and left as the voltage increases, so that two absorption lines may be attacked simultaneously. If this happens, we can differentiate between them only if one of them is in coincidence with a bromine line and the other not. What is most needed just now is one or more other filters similar to bromine vapour, but I have not been able to find anything with sufficiently narrow lines, though I have tried a number of vapours which looked promising. What would be still better would be to alter the wave-length of a narrow exciting line so as to cause it to pass by degrees from one absorption line to the next. It may be possible to accomplish this by admitting hydrogen to the Cooper-Hewitt lamp, though I fear that this will broaden the line as well as shift it. I shall try putting the mercury lamp in a magnetic field, as soon as a Weiss magnet is available.

If we examine the resonance spectrum as a whole, we find that it is made up of groups more or less similar to the groups which we have considered somewhat minutely, and fainter groups of less sharply defined lines (hazy triplets such as the 2nd and 4th order groups of the 90 volt excitation shown in fig. 2). Their arrangement in the spectrum is worthy of remark, for we find the arrangement repeating itself. If we call the hazy triplets H, and the groups of sharp lines S, the complete spectrum is represented thus :

Order	-1	0	1	2	3	4	5	6	7	8	9	10	11	12	13	14	15	16	17	18	19	20
	H	S	S	H	S	H	S	S	H	S	S	S	H	S	S	H	S	H	S	S	H	S

I have underscored the arrangement which repeats itself three times certainly, and probably four times, though there is doubt about groups 19 and 20. The sequence is interrupted at the 9th group, which is missing.

We will now consider the sharp groups which appear in the red and orange part of the spectrum. As we have seen,

the groups of order 0, 1, 3, and 5 are almost identical in appearance. At the bottom of fig. 2 (p. 834) I have given a diagram of the groups of higher order than the 6th, for the 101 volt excitation. We see that the groups of sharp lines (8, 10, 12 and 13) have the companion lines arranged differently. In group 8, for example, the spacing of the triplet to the left of the strong central triplet is very different from that which obtains in the groups of lower order, and I feel very certain that the line of shortest wave-length in this group corresponds to line No. 2 of the lower order groups. This distortion of the groups as we ascend the spectrum is, of course, due to the fact that the companion lines are differently placed with respect to the core line.

Wave-lengths excited by Hg Line 5460.7.

-2 Order.	2 Order.	6 Order.	11 Order.
5334.45 1	5583.0 1	1 5858.3 1	6228.56 1
5336.85 1	5585.1 1	5860.7 1	6231.06 1
	5587.4 2	5864.4 4	6234.0 1
-1 Order.	5589.4 3	5865.7 6	6235.96 3
5395.83 2	5591.8 2	5867.5 3	6237.36 6
5398.22 3			6239.16 4
5400.11 2	3 Order.	7 Order.	12 Order.
0 Order.	1 5649.30 2	5927.06 1	
	2 5650.87 3	5933.96 2	6310 1
1 5455.16 3	3 5652.88 4	5940.86 1	6314.36 1
2 5456.00 4	4 { 5655.75 1		6315.96 2
3 5457.34 4	5 { 5655.97 4	8 Order.	6317.26 1
4 5459.58 8	5 { 5657.06 2		
5 5460.74 10 Hg	6 { 5657.38 5	2 6000.86 3	13 Order.
6 5462.32 8	7 5658.76 3	6004.15 3	
7 5464.35 2	7 5660.50 2	6006.36 3	6388.11 2
9 5466.60 4	9 5661.40 2	6008.86 6	6394.28 2
		5 6010.26 8	6395.86 4
		6 6012.11 6	6397.76 3
1 Order.	4 Order.		
	5715.25 1	9 Order.	14 Order.
1 5518.76 2	5718.14 2	Missing.	Missing.
2 5519.69 3	{ 5720.10 3		
3 5521.32 4	{ 5720.45 3		
4 { 5523.56 4	5723.25 4	10 Order.	15 Order.
5523.78 4	5724.85 4		
5524.67 5	5726.45 3	2 6149.66 3	6559.61 2
5 5524.94 5		6153.41 2	6560.86 3
5525.12 4	5 Order.	6155.39 2	6562.66 2
5525.20 2		6159.01 5	
6 5526.52 3	1 5785.1 2	6160.46 8	
5527.15 2	2 5786.7 3	6162.26 5	
7 5528.52 3	3 5789.6 4		
9 5530.38 3	4 5793.3 8		
	5 5794.2 8		
	6 5796.3 5		
	7 5797.4 5		

In the above table are given the wave-lengths of the lines of the complete resonance spectrum excited by the green Hg line with the quartz arc operating with a potential drop of 150 volts. The numbers at the left of the wave-lengths correspond to the numbers given on fig. 2 (p. 834), and serve to identify the lines of the group with those on the diagram. The numbers to the right of the wave-lengths are roughly proportional to the intensity of the lines, 1 signifying very faint, and 10 very strong. In the case of the groups of the orders 0, 1, and 3 the wave-lengths were determined from photographs made in the fourth order spectrum of the large grating, and they can be considered correct to within 0.02 Ång. Un.

These wave-lengths were determined with reference to the new standards of iron, molybdenum, and neon. On Plate XV. fig. 3 a portion of the spectrum with the iron spectrum in coincidence is reproduced.

Excitation by the Yellow Lines.

The excitation by the yellow mercury lines is best studied by removing the green light of the lamp with a solution of eosine placed in a large glass cell between the condensing lens and the iodine tube.

I have not yet obtained records for the Cooper-Hewitt excitation, with the green light removed, but we can trace the series excited by the line of shorter wave-length on Plate XV. fig. 1, since the groups excited by this line lie well to the left of the groups excited by the green line. The groups excited by the other yellow line are covered by the much stronger groups due to the green line excitation, and can be uncovered only by the use of the eosine screen. The resonance spectrum excited by the yellow lines of the Cooper-Hewitt lamp is very faint, and long exposures will be required with the iodine tube painted with gelatine stained with eosine. With the quartz lamp at 140 volts the spectrum is strongly developed and there is no difficulty in photographing the paired groups due to the two yellow lines. These form one of the prettiest resonance spectra thus far obtained. A portion of the spectrum (six pairs of groups) is reproduced on Pl. XVI. fig. 2, the yellow Hg lines (or R.R. lines) being the second pair from the left. On Pl. XV. fig. 5 we have a smaller portion of the same spectrum made with a finer slit and showing better definition. The companion lines which accompany the R.R. lines (0 Order) come out beautifully in this photograph, and show that we are dealing

with a group formation similar to that which we had in the case of the green line. The wave-lengths of the lines are given in the following table :—

Excited by Hg 577.		Excited by Hg 579.	
6465·6	5916· 1	6498·8	5938· 2
6462·	5910·6 4	6494·	5935·4 5
6457·6	5906·6 2	6490·	5932· 3
Faint broad band,	5847·3	6409·5	5868·3 1
	5845·4	6405·8	5866·5 2
	5841·8 6	6402·8	5863·3 6
6302·5	5837·7 3		5860·7 3
6298·2		6327·5	
6293·7	5775·5 2	6324·5	5795·3 2
	5773·4 3	6321·3	5792·8 3
6217·	5769·6 10 R. R. line.		5791· 10 R. R. line.
6214· edges of band.	5765·8 4	6248·6	5789·3 3
	5763·6	6245·7	5786· 2
6142·5		6242·3	
6139· edges of band.	5705·8 1		5726·3 2
	5703·4 2	6166·4	5723·4 3
6067·5	5699·8 6	6164·	5720·3 8
6063·3	5696·6 2	6161·3	5717·8 3
6059·	5695·6 2		
5993·6 1	5634·8 1	6090·3	5654·8 2
5988· 2	5632· 3	6086·5	5651·8 4
5983·5 2	5628·6 1	6083·8	5648·8 2
	5570 Very faint.	6015·	5590· Very faint.
		6012· } edge of	
		6008· } band.	

The wave-length differences between the middle lines of these two sets of groups increase gradually as we pass up the spectrum, but as the increment varies in a slightly irregular manner there seems to be little use in expressing it numerically. By applying a pair of compasses to fig. 2 Plate XVI. we can form a good idea of the regularity of the spacing, for the spectrum is very nearly normal.

The Band Spectrum and the Line Spectrum: Effect of Reducing the Density of the Iodine Vapour.

In the course of the experiments made to determine the effect of the absorption upon the resonance spectrum some interesting observations were made. As I have shown in previous papers, the band spectrum is developed by the admixture of helium or gases of its group, at a pressure of a few millimetres, with the iodine vapour. The intensity of the resonance groups diminishes gradually and that of the band spectrum increases proportionally as the pressure of the helium increases. The same thing is true, though to a

less extent, with other gases such as nitrogen, the total intensity of the light being much less, however, for reasons given in the papers published by Wood and Franck. To reduce the absorption element as much as possible, the rear end of the iodine tube was packed in ice, or in a mixture of ice and salt, which reduced the density of the iodine vapour to a small fraction of its value at room temperature. It was found that in this case the band spectrum was quite pronounced. With the iodine vapour in a high vacuum, one always obtains a faint trace of the band spectrum if a very long exposure is given, but it was much stronger in the case of the cooled tube. The hypothesis was made that this resulted from the circumstance that the band spectrum was more strongly absorbed by the iodine vapour than the lines of the resonance groups, some of which as we have seen are absorbed scarcely at all. This was tested by passing the light from the frozen tube through a bulb containing iodine vapour at room temperature, before its entrance into the spectroscope. The band spectrum at once disappeared, showing that the hypothesis was in all probability correct. The resonance groups were uninfluenced by the cooling of the tube, except that they became fainter.

Examination of the Vapour for Phosphorescence.

An attempt to detect a possible finite duration of the light emitted by the vapour after shutting off the exciting beam, was made by focussing an image of the sun at the centre of a swiftly moving stream of iodine vapour. Two glass bulbs were joined by a tube which projected several centimetres into one of the bulbs. The iodine crystals were introduced into the other bulb and the whole system highly exhausted and sealed from the pump. On cooling the first bulb by the application of a pad of cotton-wool wet with liquid air, the iodine vapour in this bulb immediately condensed, forming a very high vacuum into which rushed the vapour, continuously formed from the crystals in the other bulb. The solar image was formed just at the mouth of the tube, but no prolongation of the fluorescent spot could be detected, as would be the case if the moving jet of vapour remained luminous after passing through the focus. A paper by Mr. F. S. Phillips has appeared in the Proc. Roy. Soc. (ser. A, vol. lxxxix.) since the completion of my work describing similar experiments with mercury vapour, which showed very persistent luminosity. It is probable that the fluorescence of mercury vapour results, in part at least, from

the return to the atoms of electrons expelled by the action of the light-waves, for there is no trace of polarization of the light. The fluorescence of iodine, sodium, and potassium vapours is strongly polarized, however, as I have shown in previous papers, and the polarization is for the light of the complete resonance spectrum (*i. e.* not confined to the R.R. line). This makes it seem probable that the fluorescence results directly from disturbances set up in the atom, and not from the falling back of electrons. On this hypothesis we should expect phosphorescence to be shown only by mercury vapour, for it is inconceivable that vibrations set up in the electron system of an atom could persist long enough to be detected. If we have, however, something analogous to dissociation and recombination, it is clear that phosphorescence may be apparent if only the latter process is sufficiently delayed.

LXXI. *The Polarization of the Light of Resonance Spectra.*

By R. W. WOOD, *Professor of Experimental Physics, Johns Hopkins University* *.

[Plate XVII.]

ONE of the most remarkable and important phenomena observed in connexion with resonance spectra is the strong polarization of the light even when the exciting light is unpolarized. In an earlier paper (*Phil. Mag.* Oct. 1911) I drew attention to this fact, and published a rough drawing of the Savart fringes as they appeared cutting across the spectrum-lines at right angles. During the past year I have repeated the observations with improved apparatus, and am now able to publish photographs which record the phenomenon. In the more recent work I have made use of a Fresnel quartz double prism of right- and left-handed rotatory power (such as is used in the study of the magnetic rotation of absorbing vapours). This was found to give fringes somewhat more distinct than the Savart plate which was at my disposal.

The light from a large quartz mercury arc running on a 220 volt circuit, with the minimum resistance allowable, was focussed along the axis of one of the iodine vacuum tubes described in the previous paper. The light was first filtered through a strong solution of neodymium which removed every trace of the yellow Hg lines, so that the

* Communicated by the Author.

excitation was by the green line alone. This was to avoid the complication resulting from simultaneous excitation at three points of the spectrum, as I wished particularly to ascertain whether the polarization was as strong for the lines far removed from the exciting line, as for those which were close to it.

Every precaution was taken to avoid scattered light and to have the luminous iodine vapour seen against an absolutely black background.

In front of the tube a screen was mounted perforated with a vertical slit about 1 mm. in width. Close against this slit the Fresnel double prism was placed so oriented that the fringes, seen by means of a Nicol prism, ran in a horizontal direction. These fringes are due to the circumstance that the plane of polarization at each point of the slit is rotated by an amount depending upon the difference between the thicknesses of the right- and left-handed quartz elements at the point in question. If no polarization is present, no bands are seen, and by compensating the polarization with one or more glass plates turned through a known angle, the percentage of polarization can be determined by the usual formula (*Physical Optics*, 2nd ed. p. 299). A long-focus lens and a direct-vision prism spread out the image of the slit into a spectrum, and the polarization fringes were found to cut across all of the lines of the resonance spectrum thus formed. By means of the compensating plates it was found that the percentage of polarization had practically the same value in all of the lines including the exciting or R.R. line (see previous paper).

If the exciting light is polarized with its electric vector vertical, before it enters the iodine vapour, the fringes become more distinct; if polarized with its electric vector horizontal, the fringes disappear, as would be expected on any theory. Two photographs of the phenomenon are reproduced in Pl. XVII. They have not been retouched or intensified in any way, and may be taken as furnishing an exact record of the distinctness of the polarization fringes. The percentage of polarization is not nearly as high as is the case with the vapours of sodium and potassium, for which I have observed 30 per cent. of polarization with the exciting light polarized. L. Dunoyer has observed 48 per cent. under similar conditions, working however with the vapour in glass bulbs. In my experiments I used a steel tube provided with a lateral branch for observation.

In the case of iodine excited by the green mercury line,

the polarization was measured by compensating plates of glass. The following values were obtained:—

Polarization of Resonance Spectrum of Iodine <i>in vacuo</i> .	Polarization of Resonance Spectrum of Iodine in Helium at 3.8 mm. pressure.
With exciting light polarized : 11 per cent. With exciting light unpolarized : 6.4 per cent.	With exciting light unpolarized : 4 per cent.

The important point to notice is that the polarization is the same for all of the lines. This seems to prove that the numerous vibrations giving rise to lines of the resonance spectrum are set up within the atom or molecule by the vibration of the electron which responds to the monochromatic exciting light, in other words, it does not result from anything like dissociation and recombination.

J. Stark has attempted to adapt his dissociation theory of fluorescence to cases where the vapour shows polarization by assuming that the electron, expelled by the action of the absorbed light, falls back into the atom in practically the same direction,—in other words, that it never gets away from the field of force of the atom. This is an interesting suggestion, but it appears to me to be a compromise, for we can regard the expulsion of the electron under such conditions as a vibration of large amplitude. It may be possible to obtain some experimental evidence of the phenomenon (as, for example, the reduction of the percentage of polarization by collisions with helium molecules), but until such evidence is obtained it appears to me to be simpler to regard the resonance spectra as produced by vibrations originated in a more or less direct manner by the exciting light.

LXXII. *New Experiments on the Virtual Anode in the Tubes for Magnetic Rays.* By AUGUSTO RIGHI, of the University, Bologna*.

SINCE I published my Note: "On Magnetic Rays in Different Gases" †, in reply to that bearing the same title by Messrs. L. T. More and E. Rieman ‡, I had proposed to examine again the experiments on magnetic rays which

* Communicated by the Author.

† Phil. Mag., November 1912, p. 804.

‡ Phil. Mag., August 1912, p. 307.

the latter physicists had repeated, and which had given them results different from mine, when they employed gases different from air. Only recently I have had leisure to satisfy such desire by a series of numerous experiments which I shall fully describe and discuss before long in a special publication. In the present Note I intend, in the meantime, to make known the results which I have obtained, after which I shall occupy myself with a new paper due to Messrs. More and Mauchly *, concerning which I find a few remarks sufficient for the present.

The experiment in question has so often been described, and as lately as in More and Rieman's paper, that I may consider it as well known to the reader. The experiment shows that, when through the action of the magnetic field there appears, with unusual extension, a beam of cathodic rays presenting certain features, which had induced physicists to give them a special denomination (cathodic rays of the second kind, or magnetocathodic rays, or magnetic rays), and that on the prolongation of them another one may appear having the colour and characters of the positive column of the usual discharge.

To this column, which constitutes a secondary phenomenon due to the magnetic rays, More and Rieman give the name of "induced column." Formerly I did not think it necessary to give it a special name; in order to avoid misunderstandings, however, I have also called it thus in the Note above quoted. But, as there is in this case no real phenomenon of induction, I shall henceforward indicate it by the name of "secondary column."

The phenomenon is produced particularly well with the tubes I have especially made, which have the cathode at one of the ends next to the pole of the coil producing the magnetic field, and arranged so as to have its axis on the prolongation of the axis of the coil, while the anode is placed in a side branch.

The reader may see the shape of the tubes in my publications as well as in More and Rieman's Note (fig. 1, p. 308) †.

The principal experiment is carried out by observing the action produced on the secondary column by a feeble transversal magnetic field obtained, for example, by means

* *Phil. Mag.*, August 1913, p. 252.

† [The figure referred to is reproduced on page 850 for the convenience of the reader.—EDS. *PHIL. MAG.*]

of a coil. In the figure quoted BE is the beam of magnetic rays, EF the secondary column, and S the exploring coil. The effect which may be observed is a deformation of the secondary column, such as might be produced if, in a given

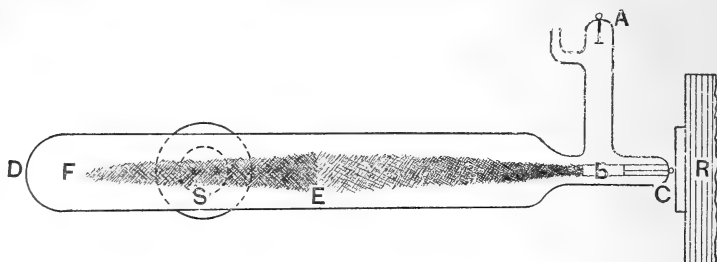

region of the same, an anode (*virtual anode*) existed and two cathodes were at the ends of the tube. According to the hypothesis on the nature of magnetic rays which has always guided me in my researches on the subject, these rays are not merely cathodic rays of a shape rendered helicoidal by the magnetic field, but they contain besides neutral pairs constituted by a positive ion around which revolves an electron as a satellite. Very likely such pairs can be formed in every case within an ionized gas; however, they escape notice because they are orientated without any fixed rule and are extremely unstable. But in the presence of a magnetic field such pairs, in which the electron revolves in a certain direction, are rendered less unstable, and, at the same time, the force acting on the closed current, represented by the orbit of the electron, drives them in the direction in which the intensity of the field diminishes.

From that might, in part, ensue the lengthening of the beam of magnetic rays which is noticed when the intensity of the magnetic field is caused to increase to a certain extent.

This being established, here is what may be the explanation of the virtual anode. The pairs ion-electron are incessantly destroyed through molecular collisions; but new ones are formed, in a quantity which, of course, decreases as we go towards the places where the intensity of the field becomes less.

Thus it happens, that positive ions and electrons produced by the scission of the doublets are driven by their speed towards the bottom of the tube, which most of the latter will easily reach, while the positive ions will stop before, and form the virtual anode. This long explanation is not unnecessary here in view of the objections brought forward, as the reader may now remove them by himself.

More and Rieman have completely confirmed the facts described by me as long as they employed, as I had always done before, tubes containing air, as well as when employing other gaseous mixtures containing nitrogen, while this was not the case with a pure gas, as nitrogen, hydrogen, oxygen, and carbonic anhydride.

In these cases they have seen the secondary column everywhere inflected by the transversal magnetic field as if the virtual anode did not exist at all, or more exactly as if the latter were at the end of the beam of magnetic rays*.

Before I undertook to verify this result I was perfectly inclined to admit its correctness. But I was forced to convince myself, after innumerable experiments and after taking every possible care to ascertain the purity of the gases (chiefly of hydrogen and oxygen), that with all the gases employed in the experiments the same effects as those obtained with air may be produced, on condition, however, that proper care should be taken in choosing the conditions of the experiments (size of the tube, pressure of the gas, intensity of the current through it, intensity of the magnetic field). Besides the two above-mentioned gases I have experimented also with the following, which, however, I did not think it necessary to render absolutely pure: nitrogen, carbonic anhydride, carbon monoxide, vapour of ether and of chloroform.

And here I cannot refrain from repeating, that even if it were true that it is possible to ascertain the existence of the virtual anode with certain gases and not with others, that would not at all constitute a serious objection to the hypothesis propounded by me, as the above named physicists seem to believe.

In fact, different gases, and therefore positive ions of different bulk and structure, may supply doublets having different characteristics, chiefly in regard to their stability and mobility. The influence, then, of the nature of the gas upon the phenomena is not in opposition with my theory, but it is foreseen by it and its precise ascertainment makes it more noteworthy. For this reason I have made a long series

* Although I have kept my remarks on the recent paper by More and Mauchly for the end of the present Note, I find it convenient to make one now with regard to what they say on page 254. Meaning to oppose the interpretation repeated here in the text (namely that the virtual anode may be found at the end of the magnetic rays) they state, that it necessarily must be found beyond this end at a distance equal to the free path of the ions. But by this they implicitly admit that all pairs break at the said end, while, as a matter of fact, many will break long before reaching it.

of measurements with the aim of determining in different circumstances the position occupied by the virtual anode, namely its distance from the cathode.

Such determinations, made by increasing the distance of the exploring coil as long as the secondary column in front of it remains in the axis of the tube, or is divided into two branches symmetrical with respect to the axis, cannot of course be very precise for evident reasons, among which is this, that the virtual anode seems to be often constituted by a large cloud of positive ions. By repeated experiments, however, one can obtain sufficiently clear results (especially by using a tube not less than one metre and a half in length) in order to construct a curve having as abscissæ the distances of the virtual anode from the cathode, and as ordinates the intensity of the magnetic field.

It is easy to imagine the shape of these curves, as it is already known that, the other conditions being the same, the distance of the virtual anode from the cathode increases (to a certain extent which generally is not reached if the rarefaction is sufficient) with the increasing of the field. They slightly differ from straight lines inclined upwards in the direction of the increasing abscissæ; in reality they often show, towards this axis, especially with certain gases, a certain convexity. With the same gas the curves corresponding to the different pressures are found one above the other and approaching the axis of abscissæ as rarefaction is increased. It was already known, in fact, that the positive ions go to make up the virtual anode in a place which is further away from the cathode (with parity of the magnetic field) as the molecules which may stop them are rarer, and therefore as rarefaction is greater.

The comparison between the curves obtained with the different gases has given an interesting result.

The place where the positive ions, resulting from the scission of the doublets ion-electron, arrive, depends, of course, on the speed impressed on the doublets by the magnetic force, and consequently it depends:—(1) on the area enclosed by the orbits of the electron satellite; (2) on the speed with which it is moving in this orbit; (3) on the mass of the positive ion. Not having precise data it is difficult to foresee how with equal conditions the position of the virtual anode changes with the gas. Nevertheless it seems likely, that to a great variation of the mass of the positive ions should correspond a variation in an opposite sense of the speed impressed by the magnetic field on the pair ion-electron and therefore of the distance from the cathode at which the virtual anode is

formed. Now this is just the conclusion to which one comes by the comparison between the curves relative to the various gases.

In fact, while those relative to the gases N, O, CO (respective molecular weights being 28, 32, 28) are very near each other, those relative to CO₂ (molecular weight 44) stand far above the preceding ones, while those relative to H (molecular weight 2) are to be found very much below all the others. In other terms, with parity of the magnetic field and pressure of the gas, the virtual anode is formed very far from the cathode in the case of hydrogen, much less far from the cathode in the case of nitrogen, of oxygen, and of carbon monoxide, and at an even shorter distance from the cathode in the case of carbonic anhydride (?). At the same time the total length of the luminous phenomenon (magnetic rays and secondary column) varies in a similar way. Nay, with ether and chloroform vapour (molecular weights 74, 119) one does not easily succeed in noticing the phenomenon. Traces of the said vapours are sufficient in the case of certain gases, like oxygen and hydrogen, to make it very difficult to realize the experiment of the virtual anode. As a general rule, the limits of pressure within which the phenomena in question are fully realized vary with the different gases. For example, in the case of the tube more than once used by me, the pressure may vary between 1 mm. and 0.30 mm. when containing hydrogen, while when it contains carbonic anhydride it is necessary for the pressure not to exceed much 0.36 mm., and one may reach 0.01 mm. without the effects being much altered. Among the different gases I have also noticed other differences of a smaller value. For instance, the curves I have obtained with oxygen are more inclined upwards than those relative to carbon monoxide, so that it happens that the curve of one of the gases lies partly above and partly below that of the other gas with equal pressure.

I have obtained results of some interest by using gaseous mixtures. Apart from the case of vapours, even of water steam, which seem to attenuate the phenomena, by the mixture of two gases in different proportions the following curious phenomenon is generally observed. By causing the intensity of the magnetic field to gradually increase, starting from 0, a beam of magnetic rays is first suddenly formed at a certain intensity of the field, which beam is prolonged into a short secondary column. The total length of the luminosity then attains a maximum, and subsequently diminishes to a minimum and then increases again. Sometimes I have

observed two successive maximums. Finally, if a sufficient intensity of the field be attained, the column gets shorter and may even disappear. One might therefore say that ions-electron doublets are first formed by the principal contribution of the positive ions of one of the gases, while with the more intense field the same gas approaches the conditions by which the production of magnetic rays diminishes, the latter doublets being then chiefly formed by the positive ions furnished by the second of the gases present. Of course, it is not a demonstrated fact; but this is the impression which the phenomenon gives. It has not been useless, therefore, to trace curves similar to those mentioned above, even in the case of a mixture of two gases. By mixing N and CO, I have obtained curves not very different from those, not far apart from each other, relative to the two gases taken separately. By the mixture of H and CO₂ I have obtained curves placed between those (for equal pressure) belonging to H or to CO₂, nearer to one or to the other according as the proportion of H or CO₂ in the mixture is greater. But I have studied more thoroughly the mixture of N with H. Having first obtained the indication of a virtual anode in hydrogen I have added to the latter about 1/50 of nitrogen, and the result has not varied to any sensible degree. I had to add a great deal more of nitrogen before I could ascertain any important modification.

This does not agree with the opinion that hydrogen produces the usual effects only in the presence of a trace of nitrogen. With a certain proportion of N and H and with certain pressures I have observed another peculiarity. For instance, having introduced into the tube a mixture of five parts of H and two parts of N and reduced the pressure to 0.16 mm., when I caused the exploring coil to run along the tube I found, for each intensity of field, two positions in which a virtual anode seems to exist.

The curve therefore becomes divided into two branches almost superposed in correspondence with the feeble intensity of the field, and more and more separated when the intensity is greater. Here, too, one is tempted to give the explanation suggested by the admitted hypothesis. One would say, in fact, that two virtual anodes are formed in consequence of the possibility of the formation of two kinds of ions-electron doublets, namely those containing positive ions of one of the gases and those formed at the expense of the other. The ions derived from the scission of such doublets will reach, in the tube, two regions differently distant from the cathode.

It is not easy to find the reasons of the deep divergencies

between my results and those of the two physicists quoted above.

That in my experiments the gases should always contain traces of nitrogen, I deliberately exclude. On the other hand, how would one explain the fact of my having obtained the phenomena, nay very easy and brilliant phenomena, by using nitrogen? There must be, on the contrary, special reasons, owing to which More and Rieman failed in obtaining constant results, and I feel convinced that they will confirm my results by imitating more exactly the experimental conditions which I have several times carefully described.

The causes which may have contributed to the failure are numerous, and here are the principal ones. In the first place, I have elsewhere shown that with too great intensity of the current in the gas, the limiting values of the intensity of the field, within which only the magnetic rays may be formed, lie very near each other, and therefore it may happen that with certain gases the production of the phenomena may not always be easy. In the second place, it must be noticed that More and Rieman have employed the discharges of an induction-coil and not the current (which is remarkably continuous when the magnetic field does not exist) supplied by accumulators or by a good influence machine. I had, on another occasion, an opportunity of remarking how, owing perhaps to the intermittence of the current crossing the rarified gas, the phenomena appear greatly altered, so much so that after several attempts I had to give up the use of the coil. In the third place, the shape of the tube of discharge and its scanty length may be causes of failure. I have recently noticed that a certain tube having the lateral branch so short that the distance between anode and cathode was only six centimetres, did not give in any satisfactory way the phenomenon of the virtual anode; but it was sufficient to prolong that branch so that the said distance was tripled to cause everything to proceed in the most satisfactory manner. And I do not mention other causes of uncertainty having minor importance.

After what I have stated here a few short comments on More and Mauchly's paper will be sufficient; nay, I shall merely point out a few misunderstandings, owing perhaps to lack of clearness on my part in the exposition of the matter.

For instance, on page 252 the authors say that I found that the magnetic rays do not carry a charge into a Faraday cage. That was stated, on the contrary (more as a probability than anything else), not by me but by Villard, who noticed

instead a transport of negative electricity, of course due to the cathodic rays, which exist in abundance in that flash of light which is called a beam of magnetic rays.

Certain difficulties of explanation pointed out by the authors remain then excluded, when the charges acquired by the walls of the tube are taken into consideration. They may, for example, explain the concentration of the light towards the axis. Certain other difficulties do not exist for those who take notice of the fact that the doublets ion-electron may break at every region of the tube, and that therefore the virtual anode may be extended and spread about. Lastly, it must not be forgotten that the production of the virtual anode constitutes necessarily a non-continuous phenomenon, and its manifestations must, according to the theory, alternate with the production, rendered intermittent by the field, of the principal discharge.

I must, besides, point out that what is said at the beginning of page 263 is incorrect, namely, that I have made the strange statement of the magnetic field being indispensable for the discharge to be intermittent. In fact I showed among other things in preceding publications that when a small spark in free air is inserted between the tube and the electric source, it may occasion a lighting up of the whole tube and mislead one from the fact that, under the action of the exploring coil, there may be doublings and twistings of the luminous column.

But even without the small spark one is liable to make mistakes. If, in fact, after the secondary column has lengthened down to the end of the tube by the gradual increasing of the field, the magnetic field is further augmented, a state of things is produced similar to the one due to the small spark.

In the experiments described in the last of the quoted papers the authors have employed a Wehnelt cathode. That had already been done by Mr. Berii*, who found effects mostly similar to those described by me, and principally the transport, decreasing with the increase of the field, of negative electricity.

At the end of More and Mauchly's paper, in order to contradict my hypothesis, they oppose to it their different point of view, on the basis of the variation of the potential of discharge due to the field.

They quote the works of Paalzow and Neesen, of Almy and others showing a diminution of the fall of cathodic potential, but not mine on the same subject, in which it is

* *Rend. del R. Istituto Lombardo*, 10 febbraio, 1912.

stated that cases exist in which the field makes that potential increase.

That is just what occurs with the tubes having a lateral anode used for the experiments dealt with in the present paper.

An electrometer of convenient sensibility is enough to show that, when the magnetic field generates the magnetic rays, the deviation of the *electrometer* is much greater than before, often more than double. Now, the new explanation proposed by the authors named has, as starting point, a supposed diminution of the cathode fall of potential produced by the field. I can therefore refrain from discussing it.

I shall then point out lastly, in connexion with the remark on p. 266, that it is necessary to prove the legitimacy of the application to the case of rarefied gases of the result obtained by Sir J. J. Thomson dealing with the question of the transport of ions in a magnetic field, as such statement is based on the hypothesis that the viscosity of the medium in which an ion moves, is such as to render its speed proportional to the force acting on it; which does not seem always admissible in the case of a rarefied gas.

Bologna, August 1913.

LXXIII. *On the Constitution of Atoms and Molecules.*

By N. BOHR, *Dr. phil., Copenhagen* *.

PART III.—SYSTEMS CONTAINING SEVERAL NUCLEI †.

§ 1. *Preliminary.*

ACCORDING to Rutherford's theory of the structure of atoms, the difference between an atom of an element and a molecule of a chemical combination is that the first consists of a cluster of electrons surrounding a single positive nucleus of exceedingly small dimensions and of a mass great in comparison with that of the electrons, while the latter contains at least two nuclei at distances from each other comparable with the distances apart of the electrons in the surrounding cluster.

The leading idea used in the former papers was that the atoms were formed through the successive binding by the nucleus of a number of electrons initially nearly at rest.

* Communicated by Prof. E. Rutherford, F.R.S.

† Part I. and Part II. were published in *Phil. Mag.* xxvi. p. 1 & p. 476 (1913).

Such a conception, however, cannot be utilized in considering the formation of a system containing more than a single nucleus; for in the latter case there will be nothing to keep the nuclei together during the binding of the electrons. In this connexion it may be noticed that while a single nucleus carrying a large positive charge is able to bind a small number of electrons, on the contrary, two nuclei highly charged obviously cannot be kept together by the help of a few electrons. We must therefore assume that configurations containing several nuclei are formed by the interaction of systems—each containing a single nucleus—which already have bound a number of electrons.

§ 2 deals with the configuration and stability of a system already formed. We shall consider only the simple case of a system consisting of two nuclei and of a ring of electrons rotating round the line connecting them; the result of the calculation, however, gives indication of what configurations are to be expected in more complicated cases. As in the former papers, we shall assume that the conditions of equilibrium can be deduced by help of the ordinary mechanics. In determining the absolute dimensions and the stability of the systems, however, we shall use the main hypothesis of Part I. According to this, the angular momentum of every electron round the centre of its orbit is equal to a universal value $\frac{h}{2\pi}$, where h is Planck's constant; further, the stability is determined by the condition that the total energy of the system is less than in any neighbouring configuration satisfying the same condition of the angular momentum of the electrons.

In § 3 the configuration to be expected for a hydrogen molecule is discussed in some detail.

§ 4 deals with the mode of formation of the systems. A simple method of procedure is indicated, by which it is possible to follow, step by step, the combination of two atoms to form a molecule. The configuration obtained will be shown to satisfy the conditions used in § 2. The part played in the considerations by the angular momentum of the electrons strongly supports the validity of the main hypothesis.

§ 5 contains a few indications of the configurations to be expected for systems containing a greater number of electrons.

§ 2. Configurations and Stability of the Systems.

Let us consider a system consisting of two positive nuclei of equal charges and a ring of electrons rotating round the line connecting them. Let the number of electrons in the ring be n , the charge of an electron $-e$, and the charge on each nucleus Ne . As can be simply shown, the system will be in equilibrium if the nuclei are the same distance apart from the plane of the ring and if the ratio between the diameter of the ring $2a$ and the distance apart of the nuclei $2b$ is given by

$$b = a \left(\left(\frac{4n}{N} \right)^{\frac{2}{3}} - 1 \right)^{-\frac{1}{2}}, \quad (1)$$

provided that the frequency of revolution ω is of a magnitude such that for each of the electrons the centrifugal force balances the radial force due to the attraction of the nuclei and the repulsion of the other electrons. Denoting this force by $\frac{e^2}{a^2}F$, we get from the condition of the universal constancy of the angular momentum of the electrons, as shown in Part II. p. 478,

$$a = \frac{h^2}{4\pi^2 e^2 m} F^{-1} \quad \text{and} \quad \omega = \frac{4\pi^2 e^4 m}{h^3} F^2. \quad . . (2)$$

The total energy necessary to remove all the charged particles to infinite distances from each other is equal to the total kinetic energy of the electrons and is given by

$$W = \frac{2\pi^2 e^4 m}{h^2} \Sigma F^2. \quad (3)$$

For the system in question we have

$$F = \frac{N^2}{2n} \left(\left(\frac{4n}{N} \right)^{\frac{2}{3}} - 1 \right)^{\frac{3}{2}} - s_n, \quad . . . (4)$$

where

$$s_n = \sum_{s=1}^{s=n-1} \operatorname{cosec} \frac{s\pi}{n};$$

a table of s_n is given in Part II. on p. 482.

To test the stability of the system we have to consider displacements of the orbits of the electrons relative to the nuclei, and also displacements of the latter relative to each other.

A calculation based on the ordinary mechanics gives that

the systems are unstable for displacements of the electrons in the plane of the ring. As for the systems considered in Part II., we shall, however, assume that the ordinary principles of mechanics cannot be used in discussing the problem in question, and that the stability of the systems for the displacements considered is secured through the introduction of the hypothesis of the universal constancy of the angular momentum of the electrons. This assumption is included in the condition of stability stated in § 1. It should be noticed that in Part II. the quantity F was taken as a constant, while for the systems considered here, F , for fixed positions of the nuclei, varies with the radius of the ring. A simple calculation, however, similar to that given in Part II. on p. 480, shows that the increase in the total energy of the system for a variation of the radius of the ring from a to $a + \delta a$, neglecting powers of δa greater than the second, is given by

$$\delta(P + T) = T \left(1 + \frac{a}{F} \frac{\partial F}{\partial a} \right) \left(\frac{\delta a}{a} \right)^2,$$

where T is the total kinetic energy and P the potential energy of the system. Since for fixed positions of the nuclei F increases for increasing a ($F = 0$ for $a = 0$; $F = 2N - s_n$ for $a = \infty$), the term dependent on the variation of F will be positive, and the system will consequently be stable for the displacement in question.

From considerations exactly corresponding to those given in Part II. on p. 481, we get for the condition of stability for displacements of the electrons perpendicular to the plane of the ring

$$G > p_{n,o} - p_{n,m}, \quad \dots \dots \dots (5)$$

where $p_{n,o} - p_{n,m}$ has the same signification as in Part II., and $\frac{e^2}{a^3} G \delta z$ denotes the component, perpendicular to the plane of the ring, of the force due to the nuclei, which acts upon one of the electrons in the ring when it has suffered a small displacement δz perpendicular to the plane of the ring. As for the systems considered in Part II., the displacements can be imagined to be produced by the effect of extraneous forces acting upon the electrons in direction parallel to the axis of the system.

For a system of two nuclei each of charge Ne and with a ring of n electrons, we find

$$G = \frac{N^2}{2n} \left(\left(\frac{4n}{N} \right)^{\frac{2}{3}} - 1 \right)^{\frac{2}{3}} \left(1 - 3 \left(\frac{N}{4n} \right)^{\frac{2}{3}} \right). \quad \dots \dots (6)$$

By help of this expression and using the table for $p_{n,0} - p_{n,m}$ given on p. 482 in Part II., it can be simply shown that the system in question will not be stable unless $N = 1$ and n equal to 2 or 3.

In considering the stability of the systems for a displacement of the nuclei relative to each other, we shall assume that the motions of the nuclei are so slow that the state of motion of the electrons at any moment will not differ sensibly from that calculated on the assumption that the nuclei are at rest. This assumption is permissible on account of the great mass of the nuclei compared with that of the electrons, which involves that the vibrations resulting from a displacement of the nuclei are very slow compared with those due to a displacement of the electrons. For a system consisting of a ring of electrons and two nuclei of equal charge, we shall thus assume that the electrons at any moment during the displacement of the nuclei move in circular orbits in the plane of symmetry of the latter.

Let us now imagine that, by help of extraneous forces acting on the nuclei, we slowly vary the distance between them. During the displacement the radius of the ring of electrons will vary in consequence of the alteration of the radial force due to the attraction of the nuclei. During this variation the angular momentum of each of the electrons round the line connecting the nuclei will remain constant. If the distance apart of the nuclei increases, the radius of the ring will obviously also increase; the radius, however, will increase at a slower rate than the distance between the nuclei. For example, imagine a displacement in which the distance as well as the radius are both increased to α times their original value. In the new configuration the radial force acting on an electron from the nuclei and the other electrons is $\frac{1}{\alpha^2}$ times that in the original configuration. From the constancy of the angular momentum of the electrons during the displacement, it further follows that the velocity of the electrons in the new configuration is $\frac{1}{\alpha}$ times, and the centrifugal force $\frac{1}{\alpha^3}$ times that in the original. Consequently, the radial force is greater than the centrifugal force.

On account of the distance between the nuclei increasing faster than the radius of the ring, the attraction on one of the nuclei due to the ring will be greater than the repulsion from the other nucleus. The work done during the displacement by the extraneous forces acting on the nuclei will therefore

be positive, and the system will be stable for the displacement. Obviously the same result will hold in the case of the distance between the nuclei diminishing. It may be noticed that in the above considerations we have not made use of any new assumption on the dynamics of the electrons, but have only used the principle of the invariance of the angular momentum, which is common both for the ordinary mechanics and for the main hypothesis of § 1.

For a system consisting of a ring of electrons and two nuclei of unequal charge, the investigation of the stability is more complicated. As before, we find that the systems are always stable for displacements of the electrons in the plane of the ring; also an expression corresponding to (5) will hold for the condition of stability for displacements perpendicular to the plane of the ring. This condition, however, will not be sufficient to secure the stability of the system. For a displacement of the electrons perpendicular to the plane of the ring, the variation of the radial force due to the nuclei will be of the same order of magnitude as the displacement; therefore, in the new configuration the radial force will not be in equilibrium with the centrifugal force, and, if the radius of the orbits is varied until the radial equilibrium is restored, the energy of the system will decrease. This circumstance must be taken into account in applying the condition of stability of § 1. Similar complications arise in the calculation of stability for displacements of the nuclei. For a variation of the distance apart of the nuclei not only will the radius of the ring vary but also the ratio in which the plane of the ring divides the line connecting the nuclei. As a consequence, the full discussion of the general case is rather lengthy; an approximate numerical calculation, however, shows that the systems, as in the former case, will be unstable unless the charges on the nuclei are small and the ring contains very few electrons.

The above considerations suggest configurations of systems, consisting of two positive nuclei and a number of electrons, which are consistent with the arrangement of the electrons to be expected in molecules of chemical combinations. If we thus consider a neutral system containing two nuclei with great charges, it follows that in a stable configuration the greater part of the electrons must be arranged around each nucleus approximately as if the other nucleus were absent; and that only a few of the outer electrons will be arranged differently rotating in a ring round the line connecting the nuclei. The latter ring, which keeps the system together, represents the chemical "bond."

A first rough approximation of the possible configuration of such a ring can be obtained by considering simple systems consisting of a single ring rotating round the line connecting two nuclei of minute dimensions. A detailed discussion, however, of the configuration of systems containing a greater number of electrons, taking the effect of inner rings into account, involves elaborate numerical calculations. Apart from a few indications given in § 5, we shall in this paper confine ourselves to systems containing very few electrons.

§ 3. *Systems containing few Electrons. The Hydrogen Molecule.*

Among the systems considered in § 2 and found to be stable the system formed of a ring of two electrons and of two nuclei of charge e is of special interest, as it, according to the theory, may be expected to represent a neutral hydrogen molecule.

Denoting the radius of the ring by a and the distances apart of the nuclei from the plane of the ring by b , we get from (1), putting $N=1$ and $n=2$,

$$b = \frac{1}{\sqrt{3}} a;$$

from (4) we further get

$$F = \frac{3\sqrt{3}-1}{4} = 1.049.$$

From (2) and (3) we get, denoting as in Part II. the values of a , ω , and W for a system consisting of a single electron rotating round a nucleus of charge e (a hydrogen atom) by a_0 , ω_0 , and W_0 ,

$$a = 0.95 a_0, \quad \omega = 1.10 \omega_0, \quad W = 2.20 W_0.$$

Since $W > 2W_0$, it follows that two hydrogen atoms combine into a molecule with emission of energy. Putting $W_0 = 2.0 \cdot 10^{-11}$ erg (comp. Part II, p. 488) and $N = 6.2 \cdot 10^{23}$, where N is the number of molecules in a gram-molecule, we get for the energy emitted during the formation of a gram-molecule of hydrogen from hydrogen atoms $(W - 2W_0)N = 2.5 \cdot 10^{12}$, which corresponds to $6.0 \cdot 10^4$ cal. This value is of the right order of magnitude; it is, however, considerably less than the value $13 \cdot 10^4$ cal. found by Langmuir* by measuring the heat conduction through the gas from an incandescent wire in hydrogen. On account of the indirect

* I. Langmuir, Journ. Amer. Chem. Soc. xxxiv. p. 860 (1912).

method employed it seems difficult to estimate the accuracy to be ascribed to the latter value. In order to bring the theoretical value in agreement with Langmuir's value, the magnitude of the angular momentum of the electrons should be only $2/3$ of that adopted; this seems, however, difficult to reconcile with the agreement obtained on other points.

From (6) we get $G = \frac{3\sqrt{3}}{16} = 0.325$. For the frequency of vibration of the whole ring in the direction parallel to the axis of the system we get

$$\nu = \omega_0 \sqrt{G \frac{a_0^3}{a^3}} = 0.61\omega_0 = 3.8 \cdot 10^{15} \text{ 1/sec.}$$

We have assumed in Part I. and Part II. that the frequency of radiation absorbed by the system and corresponding to vibrations of the electrons in the plane of the ring cannot be calculated from the ordinary mechanics, but is determined by the relation $h\nu = E$, where h is Planck's constant, and E the difference in energy between two different stationary states of the system. Since we have seen in § 2 that a configuration consisting of two nuclei and a single electron rotating round the line between them is unstable, we may assume that the removing of one of the electrons will lead to the breaking up of the molecule into a single nucleus and a hydrogen atom. If we consider the latter state as one of the stationary states in question we get

$$E = W - W_0 = 1.20 W_0, \quad \text{and} \quad \nu = 1.2 \frac{W_0}{h} = 3.7 \cdot 10^{15} \text{ 1/sec.}$$

The value for the frequency of the ultra-violet absorption line in hydrogen calculated from experiments on dispersion is $\nu = 3.5 \cdot 10^{15}$ 1/sec.* Further, a calculation from such experiments based on Drude's theory gives a value near two for the number of electrons in a hydrogen molecule. The latter result might have connexion with the fact that the frequencies calculated above for the radiation absorbed corresponding to vibrations parallel and perpendicular to the plane of the ring are nearly equal. As mentioned in Part II., the number of electrons in a helium atom calculated from experiments on dispersion is only about $2/3$ of the number of electrons to be expected in the atom, viz. two. For a helium atom, as for a hydrogen molecule, the frequency determined by the relation $\nu \cdot h = E$ agrees closely with the frequency observed from dispersion; in the helium system, however, the frequency

* C. and M. Cuthbertson, Proc. Roy. Soc. lxxxiii. p. 151 (1910).

corresponding to vibrations perpendicular to the plane of the ring is more than three times as great as the frequency in question, and consequently of negligible influence on the dispersion.

In order to determine the frequency of vibration of the system corresponding to displacement of the nuclei relative to each other, let us consider a configuration in which the radius of the ring is equal to y , and the distance apart of the nuclei $2x$. The radial force acting on one of the electrons and due to the attraction from the nuclei and the repulsion from the other electron is

$$R = \frac{2e^2y}{(y^2 + x^2)^{\frac{3}{2}}} - \frac{e^2}{4y^2}.$$

Let us now consider a slow displacement of the system during which the radial force balances the centrifugal force due to the rotation of the electrons, and the angular momentum of the latter remains constant. Putting $R = \frac{e^2}{y^2} F$, we have seen on p. 859 that the radius of the ring is inversely proportional to F . Therefore, during the displacement considered, Ry^3 remains constant. This gives by differentiation

$$(8y^5 + 32y^3x^2 - (x^2 + y^2)^{\frac{5}{2}})dy - 24xy^4dx = 0.$$

Introducing $x=b$ and $y=a$, we get

$$\frac{dy}{dx} = \frac{27}{21\sqrt{3}-4} = 0.834.$$

The force acting on one of the nuclei due to the attraction from the ring and the repulsion from the other nucleus is

$$Q = \frac{2e^2x}{(x^2 + y^2)^{\frac{3}{2}}} - \frac{e^2}{4x^2}.$$

For $x=b$, $y=a$ this force is equal to 0.

Corresponding to a small displacement of the system for which $x=a+\delta x$ we get, using the above value for $\frac{dy}{dx}$ and putting $Q = \frac{e^2}{a^3} H\delta x$,

$$H = \frac{27}{16} \left(\sqrt{3} - \frac{dy}{dx} \right) = 1.515.$$

For the frequency of vibration corresponding to the displacement in question we get, denoting the mass of one of

the nuclei by M ,

$$\nu = \omega_0 \sqrt{\frac{m}{M}} \frac{H}{a^3} = 1.32 \omega_0 \sqrt{\frac{m}{M}}$$

Putting $\frac{M}{m} = 1835$ and $\omega_0 = 6.2 \cdot 10^{15}$, we get

$$\nu = 1.91 \cdot 10^{14}.$$

This frequency is of the same order of magnitude as that calculated by Einstein's theory from the variation of the specific heat of hydrogen gas with temperature*. On the other hand, no absorption of radiation in hydrogen gas corresponding to this frequency is observed. This is, however, just what we should expect on account of the symmetrical structure of the system and the great ratio between the frequencies corresponding to displacements of the electrons and of the nuclei. The complete absence of infra-red absorption in hydrogen gas might be considered as a strong argument in support of a constitution of a hydrogen molecule like that adopted here, compared with model-molecules in which the chemical bond is assumed to have its origin in an opposite charge of the entering atoms.

As will be shown in § 5, the frequency calculated above can be used to estimate the frequency of vibration of more complicated systems for which an infra-red absorption is observed.

The configuration of two nuclei of charge e and a ring of three electrons rotating between them will, as mentioned in § 2, also be stable for displacements of the electrons perpendicular to the plane of the ring. A calculation gives

$$\frac{b}{a} = 0.486, \quad G = 0.623, \quad \text{and} \quad F = 0.879;$$

and further,

$$a = 1.14a_0, \quad \omega = 0.77\omega_0, \quad W = 2.32W_0.$$

Since W is greater than for the system consisting of two nuclei and two electrons, the system in question may be considered as representing a negatively charged hydrogen molecule. Proof of the existence of such a system has been obtained by Sir J. J. Thomson in his experiments on positive rays †.

A system consisting of two nuclei of charge e and a single

* See N. Bjerrum, *Zeitschr. f. Elektrochem.* xvii. p. 731 (1911); xviii. p. 101 (1912).

† J. J. Thomson, *Phil. Mag.* xxiv. p. 253 (1912).

electron rotating in a circular orbit round the line connecting the nuclei, is unstable for a displacement of the electron perpendicular to its orbit, since in the configuration of equilibrium $G < 0$. The explanation of the appearance of positively charged hydrogen molecules in experiments on positive rays may therefore at first sight be considered as a serious difficulty for the present theory. A possible explanation, however, might be sought in the special conditions under which the systems are observed. We are probably dealing in such a case not with the formation of a stationary system by a regular interaction of systems containing single nuclei (see the next section), but rather with a delay in the breaking up of a configuration brought about by the sudden removal of one of the electrons by impact of a single particle.

Another stable configuration containing a few electrons is one consisting of a ring of three electrons and two nuclei of charges e and $2e$. A numerical calculation gives

$$\frac{b_1}{a} = 1.446, \quad \frac{b_2}{a} = 0.137, \quad F = 1.552,$$

where a is the radius of the ring and b_1 and b_2 the distances apart of the nuclei from the plane of the ring. By help of (2) and (3) we further get

$$a = 0.644a_0, \quad \omega = 2.41\omega_0, \quad W = 7.22W_0,$$

where ω is the frequency of revolution and W the total energy necessary to remove the particles to infinite distances from each other. In spite of the fact that W is greater than the sum of the values of W for a hydrogen and a helium atom ($W_0 + 6.13W_0$; comp. Part II. p. 489), the configuration in question cannot, as will be shown in the next section, be considered to represent a possible molecule of hydrogen and helium.

The vibration of the system corresponding to a displacement of the nuclei relative to each other shows features different from the system considered above of two nuclei of charge e and two electrons. If, for example, the distance between the nuclei is increased, the ring of electrons will approach the nucleus of charge $2e$. Consequently, the vibration must be expected to be connected with an absorption of radiation.

§ 4. Formation of the Systems.

As mentioned in § 1, we cannot assume that systems containing more than one nucleus are formed by successive binding of electrons, such as we have assumed for the

systems considered in Part II. We must assume that the systems are formed by the interaction of others, containing single nuclei, which already have bound electrons. We shall now consider this problem more closely, starting with the simplest possible case, viz., the combination of two hydrogen atoms to form a molecule.

Consider two hydrogen atoms at a distance apart great in comparison with the linear dimensions of the orbits of the electrons, and imagine that by help of extraneous forces acting on the nuclei, we make these approach each other; the displacements, however, being so slow that the dynamical equilibrium of the electrons for every position of the nuclei is the same as if the latter were at rest.

Suppose that the electrons originally rotate in parallel planes perpendicular to the straight line connecting the nuclei, and that the direction of rotation is the same and the difference in phase equal to half a revolution. During the approach of the nuclei, the direction of the planes of the orbits of the electrons and the difference in phase will be unaltered. The planes of the orbits, however, will at the beginning of the process approach each other at a higher rate than do the nuclei. By the continued displacement of the latter the planes of the orbits of the electrons will approach each other more and more, until finally for a certain distance apart of the nuclei the planes will coincide, the electrons being arranged in a single ring rotating in the plane of symmetry of the nuclei. During the further approach of the nuclei the ratio between the diameter of the ring of electrons and the distance apart of the nuclei will increase, and the system will pass through a configuration in which it will be in equilibrium without the application of extraneous forces on the nuclei.

By help of a calculation similar to that indicated in § 2, it can be simply shown that at any moment during this process the configuration of the electrons is stable for a displacement perpendicular to the plane of the orbits. In addition, during the whole operation the angular momentum of each of the electrons round the line connecting the nuclei will remain constant, and the configuration of equilibrium obtained will therefore be identical with the one adopted in § 3 for a hydrogen molecule. As there shown, the configuration will correspond to a smaller value for the total energy than the one corresponding to two isolated atoms. During the process, the forces between the particles of the system will therefore have done work against the extraneous forces acting on the nuclei; this fact may be expressed by

saying that the atoms have "attracted" each other during the combination. A closer calculation shows that for any distance apart of the nuclei greater than that corresponding to the configuration of equilibrium, the forces acting on the nuclei, due to the particles of the system, will be in such a direction as to diminish the distance between the nuclei; while for any smaller distance the forces will have the opposite direction.

By means of these considerations, a possible process is indicated for the combination of two hydrogen atoms to form a molecule. This operation can be followed step by step without introducing any new assumption on the dynamics of the electrons, and leads to the same configuration adopted in § 3 for a hydrogen molecule. It may be recalled that the latter configuration was deduced directly by help of the principal hypothesis of the universal constancy of the angular momentum of the electrons. These considerations also offer an explanation of the "affinity" of two atoms. It may be remarked that the assumption in regard to the slowness of the motion of the nuclei relative to those of the electrons is satisfied to a high degree of approximation in a collision between two atoms of a gas at ordinary temperatures. In assuming a special arrangement of the electrons at the beginning of the process, very little information, however, is obtained by this method on the chance of combination due to an arbitrary collision between two atoms.

Another way in which a neutral hydrogen molecule may be formed is by the combination of a positively and a negatively charged atom. According to the theory a positively charged hydrogen atom is simply a nucleus of vanishing dimensions and of charge e , while a negatively charged atom is a system consisting of a nucleus surrounded by a ring of two electrons. As shown in Part II., the latter system may be considered as possible, since the energy emitted by the formation of it is greater than the corresponding energy for a neutral hydrogen atom. Let us now imagine that, by a slow displacement of the nuclei, as before, a negatively and a positively charged atom combine. We must assume that, when the nuclei have approached a distance equal to that in the configuration adopted for a hydrogen molecule, the electrons will be arranged in the same way, since this is the only stable configuration for this distance in which the angular momentum of the electrons has the value prescribed by the theory. The state of motion of the electrons will, however, not vary in a continuous way with the displacement

of the nuclei as in the combination of two neutral atoms. For a certain distance apart of the nuclei the configuration of the electrons will be unstable and suddenly change by a finite amount; this is immediately deduced from the fact that the motion of the electrons by the combination of two neutral hydrogen atoms considered above, passes through an uninterrupted series of stable configurations. The work done by the system against the extraneous forces acting on the nuclei will therefore, in the case of the combination of a negatively and a positively charged atom, not be equal to the difference in energy between the original and the final configuration; but in passing through the unstable configurations a radiation of energy must be emitted, corresponding to that emitted during the binding of electrons by a single nucleus and considered in Parts I. and II.

On the above view, it follows that in the breaking up of a hydrogen molecule by slowly increasing the distance apart of the nuclei, we obtain two *neutral* hydrogen atoms and not a positively and a negatively charged one. This is in agreement with deductions drawn from experiments on positive rays*.

Next imagine that instead of two hydrogen atoms we consider two helium atoms, *i. e.* systems consisting of a nucleus of charge $2e$ surrounded by a ring of two electrons, and go through a similar process to that considered on p. 868. Assume that the helium atoms at the beginning of the operation are orientated relatively to each other like the hydrogen atoms, but with the exception that the phases of the electrons in the helium atoms differ by one quarter of a revolution instead of one half revolution as in the case of hydrogen. By the displacement of the nuclei, the planes of the rings of electrons will, as in the former case, approach each other at a higher rate than the nuclei, and for a certain position of the latter the planes will coincide. During the further approach of the nuclei, the electrons will be arranged at equal angular intervals in a single ring. As in the former case, it can be shown that at any moment during this operation the system will be stable for a displacement of the electrons perpendicular to the plane of the rings. Contrary, however, to what took place in the case of hydrogen, the extraneous forces to be applied to the nuclei in order to keep the system in equilibrium will always be in a direction to diminish the distance apart of the nuclei, and the system will never pass through a configuration of equilibrium; the helium atoms

* Comp. J. J. Thomson, Phil. Mag. xxiv. p. 248 (1912).

will, during the process, "repel" each other. The consideration offers an explanation of the refusal of helium atoms to combine into molecules by a close approach of the atoms.

Instead of two hydrogen or two helium atoms, next consider a hydrogen and a helium atom, and let us slowly approach the nuclei to each other in a similar way. In this case, contrary to the former cases, the electrons will have no tendency to flow together in a single ring. On account of the great difference in the radii of the orbits of the electrons in hydrogen and helium, the electron of the hydrogen atom must be expected to rotate always outside the helium ring, and if the nuclei are brought very close together, the configuration of the electrons will coincide with that adopted in Part II. for a lithium atom. Further, the extraneous forces to be applied to the nuclei during the process will be in such a direction as to diminish the distance apart. In this way, therefore, we cannot obtain a combination of the atoms.

The stable configuration considered in § 3, consisting of a ring of three electrons and two nuclei of charge e and $2e$, cannot be expected to be formed by such a process, unless the ring of electrons were bound originally by one of the nuclei. Neither a hydrogen nor a helium nucleus will, however, be able to bind a ring of three electrons, since such a configuration would correspond to a greater total energy than the one in which the nucleus has bound two electrons (comp. Part II. pp. 488 and 490). As mentioned in § 3, such a configuration cannot therefore be considered as representing a possible combination of hydrogen and helium, in spite of the fact that the value of W is greater than the sum of the values of W for a hydrogen and a helium atom. As we shall see in the next section, the configuration may, however, give indications of the possible structure of the molecules of a certain class of chemical combinations.

§ 5. *Systems containing a greater number of Electrons.*

From the considerations of the former section we are led to indications of the configuration of the electrons in systems containing a greater number of electrons, consistent with those obtained in § 2.

Let us imagine that, in a similar way to that considered on p. 868 for two hydrogen atoms, we make two atoms containing a large number of electrons approach each other. During the beginning of the process the effect on the configuration of the inner rings will be very small compared with the effect on the electrons in the outer rings, and the

final result will mainly depend on the number of electrons in these rings. If, for example, the outer ring in both atoms contains only one electron, we may expect that during the approach these two electrons will form a single ring as in the case of hydrogen. By a further approach of the nuclei, the system will arrive at a state of equilibrium before the distance apart of the nuclei is comparable with the radii of the inner rings of electrons. If the distance be decreased still further, the repulsion of the nuclei will predominate and tend to prevent an approach of the systems.

In this way we are led to a possible configuration of a molecule of a combination of two monovalent substances—such as HCl—in which the ring of electrons representing the chemical bond is arranged in a similar way to that assumed for a hydrogen molecule. Since, however, as in the case of hydrogen, the energy emitted by a combination of the atoms is only a small part of the kinetic energy of the outer electrons, we may expect that small differences in the configuration of the ring, due to the presence of inner rings of electrons in the atoms, will be of great influence on the heat of combination and consequently on the affinity of the substances. As mentioned in § 2, a detailed discussion of these questions involves elaborate numerical calculations. We may, however, make an approximate comparison of the theory with experiment, by considering the frequency of vibration of the two atoms in the molecule relative to each other. In § 3, p. 866, we have calculated this frequency for a hydrogen molecule. Since now the binding of the atoms is assumed to be similar to that in hydrogen, the frequency of another molecule can be simply calculated if we know the ratio of the mass of the nuclei to be that of a hydrogen nucleus. Denoting the frequency of a hydrogen molecule by ν_0 and the atomic weights of the substances entering in the combination in question by A_1 and A_2 respectively, we get for the frequency

$$\nu = \nu_0 \sqrt{\frac{A_1 + A_2}{2 A_1 A_2}}$$

If the two atoms are identical the molecule will be exactly symmetrical, and we cannot expect an absorption of radiation corresponding to the frequency in question (comp. p. 866). For HCl gas an infra-red absorption band corresponding to a frequency of about $8.5 \cdot 10^{13}$ is observed*. Putting in the above formula $A_1 = 1$ and $A_2 = 35$ and using the value for ν_0

* See H. Kayser, *Handb. d. Spectr.* iii. p. 366 (1905).

on p. 866, we get $\nu = 13.7 \cdot 10^{13}$. On account of the approximation introduced the agreement may be considered as satisfactory.

The molecules in question may also be formed by the combination of a positively and a negatively charged atom. As in the case of hydrogen, however, we shall expect to obtain two *neutral* atoms by the breaking up of the molecule. There may be another type of molecule, for which this does not hold, viz., molecules which are formed in a manner analogous to the system consisting of a ring of three electrons and two nuclei of charges e and $2e$, mentioned in the former section. As we have seen, the necessary condition for the formation of a configuration of this kind is that one of the atoms in the molecule is able to bind three electrons in the outer ring. According to the theory, this condition is not satisfied for a hydrogen or a helium atom, but is for an oxygen atom. With the symbols used in Part II. the configuration suggested for the oxygen atom was given by 8 (4, 2, 2). From a calculation, as that indicated in Part II., we get for this configuration $W = 228.07 W_0$, while for the configuration 8 (4, 2, 3) we get $W = 228.18 W_0$. Since the latter value for W is greater than the first, the configuration 8 (4, 2, 3) may be considered as possible and as representing an oxygen atom with a single negative charge. If now a hydrogen nucleus approaches the system 8 (4, 2, 3) we may expect a stable configuration to be formed in which the outer electrons will be arranged approximately as in the system mentioned above. In a breaking up of this configuration the ring of three electrons will remain with the oxygen atom.

Such considerations suggest a possible configuration for a water molecule, consisting of an oxygen nucleus surrounded by a small ring of 4 electrons and 2 hydrogen nuclei situated on the axis of the ring at equal distances apart from the first nucleus and kept in equilibrium by help of two rings of greater radius each containing three electrons; the latter rotate in parallel planes round the axis of the system, and are situated relatively to each other so that the electrons in the one ring are placed just opposite the interval between the electrons in the other. If we imagine that such a system is broken up by slowly removing the hydrogen nuclei we should obtain two positively charged hydrogen atoms and an oxygen atom with a double negative charge, in which the outermost electrons will be arranged in two rings of three electrons each, rotating in parallel planes. The assumption of such a configuration for a water molecule offers a possible explanation of the great absorption of water for rays in the

infra-red and for the high value of its specific inductive capacity.

In the preceding we have only considered systems which possess an axis of symmetry around which the electrons are assumed to rotate in circular orbits. In systems such as the molecule CH_4 we cannot, however, assume the existence of an axis of symmetry, and consequently we must in such cases omit the assumption of exactly circular orbits. The configuration suggested by the theory for a molecule of CH_4 is of the ordinary tetrahedron type; the carbon nucleus surrounded by a very small ring of two electrons being situated in the centre, and a hydrogen nucleus in every corner. The chemical bonds are represented by 4 rings of 2 electrons each rotating round the lines connecting the centre and the corners. The closer discussion of such questions, however, is far out of the range of the present theory.

Concluding remarks.

In the present paper an attempt has been made to develop a theory of the constitution of atoms and molecules on the basis of the ideas introduced by Planck in order to account for the radiation from a black body, and the theory of the structure of atoms proposed by Rutherford in order to explain the scattering of α -particles by matter.

Planck's theory deals with the emission and absorption of radiation from an atomic vibrator of a constant frequency, independent of the amount of energy possessed by the system in the moment considered. The assumption of such vibrators, however, involves the assumption of quasi-elastic forces and is inconsistent with Rutherford's theory, according to which all the forces between the particles of an atomic system vary inversely as the square of the distance apart. In order to apply the main results obtained by Planck it is therefore necessary to introduce new assumptions as to the emission and absorption of radiation by an atomic system.

The main assumptions used in the present paper are :—

1. That energy radiation is not emitted (or absorbed) in the continuous way assumed in the ordinary electrodynamics, but only during the passing of the systems between different "stationary" states.

2. That the dynamical equilibrium of the systems in the stationary states is governed by the ordinary laws of mechanics, while these laws do not hold for the passing of the systems between the different stationary states.

3. That the radiation emitted during the transition of a system between two stationary states is homogeneous, and that the relation between the frequency ν and the total amount of energy emitted E is given by $E = h\nu$, where h is Planck's constant.

4. That the different stationary states of a simple system consisting of an electron rotating round a positive nucleus are determined by the condition that the ratio between the total energy, emitted during the formation of the configuration, and the frequency of revolution of the electron is an entire multiple of $\frac{h}{2}$. Assuming that the orbit of the electron is circular, this assumption is equivalent with the assumption that the angular momentum of the electron round the nucleus is equal to an entire multiple of $\frac{h}{2\pi}$.

5. That the "permanent" state of any atomic system—*i. e.*, the state in which the energy emitted is maximum—is determined by the condition that the angular momentum of every electron round the centre of its orbit is equal to $\frac{h}{2\pi}$.

It is shown that, applying these assumptions to Rutherford's atom model, it is possible to account for the laws of Balmer and Rydberg connecting the frequency of the different lines in the line-spectrum of an element. Further, outlines are given of a theory of the constitution of the atoms of the elements and of the formation of molecules of chemical combinations, which on several points is shown to be in approximate agreement with experiments.

The intimate connexion between the present theory and modern theories of the radiation from a black body and of specific heat is evident; again, since on the ordinary electrodynamics the magnetic moment due to an electron rotating in a circular orbit is proportional to the angular momentum, we shall expect a close relation to the theory of magnetons proposed by Weiss. The development of a detailed theory of heat radiation and of magnetism on the basis of the present theory claims, however, the introduction of additional assumptions about the behaviour of bound electrons in an electromagnetic field. The writer hopes to return to these questions later.

LXXIV. *On the Electrical Conductivity imparted to Liquid Air by Alpha Rays.* By Professor J. C. McLENNAN and DAVID A. KEYS, *University of Toronto* *.

[Plate XVIII.]

I. *Introduction.*

IN the published accounts of their experiments on the measurement of the dielectric constants of different liquefied gases, a number of investigators including Linde †, Dewar and Fleming ‡, and Hasenöhrl §, have drawn attention to the high insulating qualities possessed by such liquids. In particular, Fleming and Dewar have shown that a small condenser when immersed in liquid air and charged with a Wimshurst electrical machine held its charge perfectly for a period of some minutes. Quite recently, too, Zeeman ||, in studying the Kerr phenomenon in liquid air, found when the latter was freed from small ice and carbonic-dioxide crystals by filtration, and when precautions were taken to prevent the generation of gas-bubbles between the electrodes, electric fields as high as 90,000 volts per cm. and even higher ones could be maintained quite readily in the liquid.

Fleming and Dewar in the course of their experiments made a determination of the dielectric constant of liquefied air, and also that of liquid oxygen. The latter they found to be 1.495. If we assume the density of gaseous oxygen at 15° C. and 760 mm. pressure to be 0.00134 (and its density at -182° C. consequently to be 0.00424) and its dielectric constant at 0° C. and 760 mm. pressure to be 1.00059, it follows by applying the Clausius-Mosotti relation,—that $K-1$ is proportional to the density of the gas,—that the dielectric constant of gaseous oxygen at -182° C. and 760 mm. pressure should be approximately 1.0018.

Moreover, as the density of liquid oxygen is about 1.1375, it follows if we assume the Clausius-Mosotti's Law to hold continuously in passing from the gaseous to the liquid phase, that the dielectric constant of liquid oxygen should be

* Communicated by the Authors. Read before the Royal Society of Canada, May 26, 1913.

† Linde, *Wied. Ann.* vol. lvi. p. 546 (1895).

‡ Dewar and Fleming, *Proc. Roy. Soc. London*, vol. ix. p. 358 (1896).

§ Hasenöhrl, *Leiden Comm.* No. 52, *Proc. Amst. Akad. of Sci.* vol. xi. p. 211.

|| Zeeman, *Proc. Amst. Akad. of Sci.* p. 650, Jan. 24, 1912.

approximately 1:4824. This it will be seen is very close to the value found by Dewar and Fleming in their experiments.

In view of this continuity in the dielectric property of oxygen in passing through the stage of liquefaction, it was thought to be of interest by the writers to see if any indication of a similar continuity could be obtained in the ionization of air by alpha rays when passing from the gaseous to the liquid state. P. Curie *, Jaffe †, Cäcilia Böhm-Wendt and E. von Schweidler ‡, and Bialobjeski §, have shown that a conductivity can be impressed on certain dielectric liquids by gamma rays, but Greinacher || appears to have been the only investigator who has studied the ionization produced in such liquids by alpha rays. His experiments were made with paraffin oil and petrol ether.

Among other results he found :—

1. That the conductivity so impressed was independent of the direction of the current, and that therefore the mobilities of the positive and negative ions produced in these liquids by the alpha rays were practically identical.
2. That with petrol ether a saturation-current was obtained with a field of about 400 volts per cm., but that in the case of petroleum oil complete saturation was not obtained even when fields as high as 10,000 volts per cm. were applied : and
3. That the total ionization produced in air at atmospheric pressure when the alpha rays from a sample of polonium were completely absorbed, was about 2000 times as great as the total ionization produced in petrol ether when the radiation from the same polonium was completely absorbed by that liquid.

In the following paper an account is given of some preliminary experiments made on the ionization of liquid air by alpha rays, and from the results which are given below it will be seen that the findings of others are confirmed in regard to the high insulating power of liquid air. It will be shown, too, that the conductivity impressed by alpha rays on liquid air is similar in some regards to that obtained by Greinacher in his experiments with petroleum and petrol ether traversed by alpha rays.

* Curie, *C. R.* vol. cxxxiv. p. 420 (1902).

† Jaffe, *Ann. d. Phys.* vol. xxviii. p. 326 (1909).

‡ Böhm-Wendt and Schweidler, *Phys. Zeit.* vol. x. p. 379 (1909).

§ Bialobjeski, *Le Radium*, p. 293, Aug. 1911.

|| Greinacher, *Phys. Zeit.* 10 Jahr. No. 25, p. 986.

II. *Preliminary Experiments.*

In order to obtain an estimate of the insulating power of liquid air, a clean copper wire A was connected to earth and suspended in a Dewar flask C. A second copper wire B was also suspended in the flask in such a way as to touch neither the wire A, nor the sides or the base of the flask C. The wire B was held in position by carefully cleaned ebonite supports. It was also connected to the free quadrants of a Dolazalek electrometer and to one of the armatures of a sulphur condenser of about 2300 e.s.u. capacity.

In one experiment with this arrangement the electrode B and its connected system was charged when the flask was empty to one quarter of a volt by means of an auxiliary battery. The steady deflexion on the scale corresponding to this potential was 99.5 mm. In order to test the insulating power of the system the connexion of the auxiliary battery was broken and the leak from the system observed for an hour. The rate was found to be .48 mm. per minute, which was not very high considering that the insulated system was supported by a number of pieces of ebonite and that the air in the room possessed a very considerable humidity, since the experiments were conducted in the summer time. The Dewar flask was then filled with carefully filtered liquid air and the electrode B and the connected system again charged to $\frac{1}{4}$ of a volt. The deflexion again was found to be 99.5 divisions, and when the auxiliary battery was disconnected the second time the leak from the system for an hour was found to be only at the rate of .56 mm. per minute. This showed that the leak from the whole system was practically the same when the Dewar flask contained liquid air as when it contained only ordinary gaseous air at atmospheric pressure.

In a second set of experiments, the Dewar flask was in turn filled with amyl, ethyl, and methyl alcohol, and the electrode B and attached system was joined, with each liquid in the flask in turn, to the $\frac{1}{4}$ -volt auxiliary circuit. With the amyl alcohol the steady deflexion obtained under these circumstances was only 97.5 mm., with ethyl alcohol 76 mm., and with methyl 63 mm. With these deflexions the current from the battery to the electrode was equal to the current from the electrode through the liquid to earth. In all three cases when the auxiliary charging current was disconnected, the electrode system at once lost its charge and the electrometer needle immediately returned to the zero position. These

experiments show that of the three alcohols, the amyl was the best insulator and the methyl the poorest. The experiments also show that the liquid air was a very much better insulator than any of the three alcohols.

In another set of experiments a small air-condenser of about 100 e.s.u. capacity was made up of brass plates and inserted in a brass box, the latter being placed in a second box resting on and surrounded with wool. This condenser was charged to a potential of 894 volts with a battery of small storage-cells. When air at atmospheric pressure, carefully filtered liquid air, and xylene were in turn used as the dielectric, and the potential difference mentioned applied to the condenser, the charge obtained in each case was ascertained by discharging the condenser through a sensitive ballistic galvanometer with a specially constructed key supported upon a paraffin block.

The deflexions obtained in a series of measurements with the three dielectrics are given in Table I.

TABLE I.

Charging potential.	Deflexions on scale of galvanometer with different dielectrics.		
	Air at atmospheric pressure.	Liquid air.	Xylene.
894 volts.	11.75 mm.	16.5 mm.	21.9 mm.
	11.75	17.0	22.2
	11.4	16.75	23.0
	12.0	16.8	23.0
	11.6	16.7	24.0
	12.0	16.5	21.0
	11.50	16.5	23.5
		16.4	22.5
		16.7	23.3
		16.4	24.2
		-----	-----
	Means 11.71	16.6	22.86

These numbers, it will be seen, if we take the dielectric constants of air at atmospheric pressure to be unity, give 1.95 and 1.42 as the dielectric constants for xylene and liquid air respectively. The value obtained for liquid air is, therefore, about 50 per cent. lower than that given by Fleming and Dewar.

III. *Electrical Conductivity imparted to Liquid Air
by Alpha rays.*

(a). After we were satisfied from these preliminary experiments that the liquid air as used was quite free from any contamination which might impart a conductivity to it, a set of measurements was made with the apparatus shown in fig. 1. In this apparatus two copper plates, A and B, were

Fig. 1.

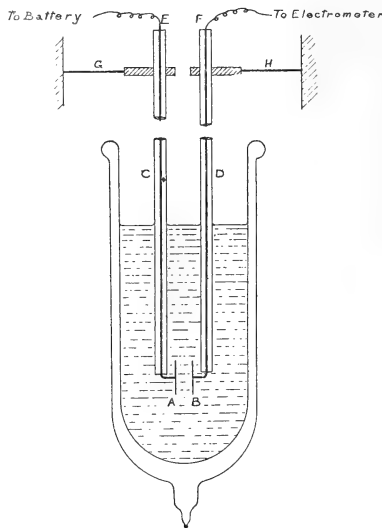

supported by two thick copper wires EA and FB. The former was surrounded with a glass tube, and the latter with a tube of clear fused quartz. Both were supported by pieces of ebonite carried by two metal rods, G and H, attached to an earthed metal case which was large enough to contain all the apparatus. The wires EA and FB were made about 60 cm. long, so that when the lower ends were immersed in liquid air their insulating supports, carried by the rods G and H, were sufficiently far removed to prevent moisture depositing on them through their being cooled below the dew-point and so spoiling the insulation at G and H.

The electrode EA was connected to a battery of small storage-cells, and the electrode FB to the free quadrants of an electrometer. Before being used the electrodes and their supporting wires were all carefully cleaned.

In carrying out these experiments the liquid air was always carefully filtered and the measurements were made as

rapidly as possible. This was done because even when the case was supplied with large quantities of P_2O_5 and concentrated sulphuric acid, moisture was always deposited on the glass and quartz tubes surrounding the wires at a point a short distance above the mouth of the Dewar flask, and whenever this deposit had gained a considerable thickness it was found that small pieces of ice and snow always fell from it into the flask and lowered considerably the insulating power of the liquid air.

In using the apparatus a set of observations was taken immediately after the filtered liquid air was poured into the flask with a series of increasing potentials applied to the electrode EA. In every case it was found on doing this that practically no current passed through the liquid air. A small plate of copper about 1 sq. cm. in area, having on it a deposit of polonium which had previously been washed in water and dried, was then attached to the face of the electrode B with the polonium facing the electrode A. A second series of readings was then taken with increasing potentials applied to EA. After this the copper plate carrying the polonium deposit was quickly removed and a third set of readings taken without it. A slight conductivity was generally obtained in this third set of readings, but its amount was found to depend very largely upon the time which was allowed to pass in taking the second and third sets of readings.

In the intervals between the first and second sets of readings and the second and third sets, care was taken to see that the deposit of snow and ice-crystals was removed from the glass and quartz tubes surrounding the wires leading to the electrodes. These tubes, the leading wires, and the electrodes were also thoroughly dried before they were inserted in the liquid air for the second as well as for the third sets of readings, in order to make certain that no moisture was introduced with them into the liquid air. All possible care was taken to prevent ice-crystals falling from the wires into the liquid air during the course of the measurements. But it was difficult to make certain that moisture did not deposit from the air upon the surface of the liquid air, and the small conductivity generally observed in the third set of readings was taken as an indication that such deposition was not entirely prevented.

The readings given in Table II. and the curves representing them in fig. 2 (Pl. XVIII.) will serve to illustrate the variation obtained with different voltages in the current through the presence of the polonium in the liquid air. In this particular

set of measurements the capacity of the electrode and the system connected with it was about 200 e.s.u., and the distance between the electrodes A and B was about 5 mm.

TABLE II.
Conductivity imparted to Liquid Air by Alpha Rays from Polonium.

Potential difference applied to electrode EA.	Deflexion of electrometer (volts per min.).
1450 volts (positive)	37.3×10^{-2}
1144	33.6 "
912	28.5 "
570	26.5 "
329	24.3 "
81	16.6 "
40.5	11.6 "

From the form of the curve it will be seen that even with the highest voltages used saturation was not obtained. There is, however, a distinct bend shown in the curve in the region corresponding to about 150 volts.

It is difficult to give a complete explanation of this bend, but in all probability the phenomenon has to do either with a volume ionization produced in the liquid air by some unknown radiation of a penetrating type from the polonium, or by beta rays due to some active impurity in the polonium. Possibly, too, it may have been due in part at least to a diffusion of ions into the body of the liquid air from the thin layer of ionization produced by the alpha rays close to the plate B. It is clear that moderate fields would in all probability suffice to remove all such ions from the field and so account for the bend. The gradual rise in the curve obtained with fields about 200 volts was no doubt due to the increasing influence exerted by the field in overcoming recombination in the ionized layer of liquid.

(b) In a second set of measurements the apparatus shown in fig. 3 was used. This consisted of a plate GH separated from a second plate EF by two small blocks of clean ebonite. The plate EF was provided with an opening shown in the figure somewhat over 1 sq. cm. in area. A third plate CABD was attached to EF by ebonite supports and was bent so that the portion AB occupied nearly all the space provided by the opening in FE.

A polonium-coated copper plate about 1 sq. cm. in area was attached in this case to AB, that portion of the plate CABD which lay within the opening in FE with its active face towards GH and with its surface in the plane of EF.

Fig. 3.

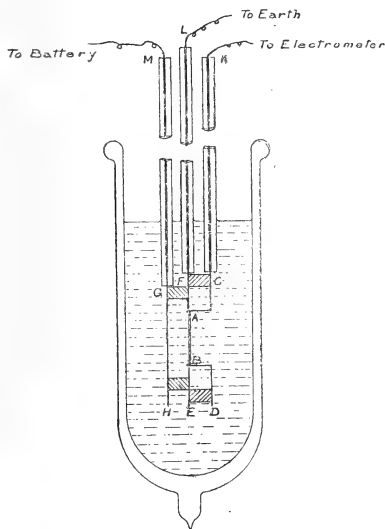

With this arrangement CABD acted as an electrode and EF as a guard-plate for it. The supports to these plates were heavy copper wires about 60 cm. in length. One of them, KC, was surrounded with a tube of clear fused quartz, and the others, LF and MG, with tubes of glass. In making the measurements the wire L was kept connected to earth, the wire M joined to a battery of storage-cells, and the terminal K to the free quadrants of the electrometer. The distance between AB and GH was about 5 mm. The capacity of the system, including the electrode AB, the free quadrants, and the leading wires, was in this case about 200 e.s.u.

A number of sets of readings was taken with this apparatus of the conductivity impressed on the liquid air by the rays from polonium, and these readings all gave curves similar to those shown in fig. 2. One set of readings taken in this way is given in Table III. and a curve representing it is shown in fig. 4 (Pl. XVIII.). The shape of this curve, it will be seen, is practically the same as that shown in fig. 2.

TABLE III.

Conductivity imparted to Liquid Air by Alpha Rays.

Potential difference applied to electrodes.	Current (rise in voltage) with positive potential applied to GH.	Current (rise in voltage) with neg. pot. applied to GH.
Volts.	Rise in volts per min.	Rise in volts per min.
1367	30.35×10^{-2}	32.7×10^{-2}
1069	21.8	29.24
765	16.6	20.76
682	16.6
645	15.2	19.33
481	14.5	15.27
323	11.2	9.19
251	9.67
162	8.95	8.35
79.2	7.68	6.80
40	5.38	5.31
20.5	3.91	4.03
16.1	3.91
10.0	2.88	3.21
8.0	1.64

It is of interest in connexion with these readings to note that the conductivity obtained with the negative fields was practically the same as that with the positive. This agrees with the results obtained by Greinacher in the ionization of petrol ether by alpha rays. As pointed out before, Greinacher, in the case of his experiments, has drawn the conclusion from his results that the positive and negative ions taking part in the conductivity impressed upon petrol ether by alpha rays have to a very close degree the same mobility. But from some experiments to be described later, it will appear that this conclusion can scarcely be drawn from the results obtained in the liquid air experiments just described.

IV. *Ionization in Air at High Pressures by Alpha Rays.*

In another set of measurements the system MH, LE, and KD with the polonium-coated plate AB in position, fig. 3, was placed in a receiver with thick steel walls, and air was pumped into it until a pressure of 101 atmospheres was reached. A set of readings similar to those obtained when the above system was immersed in liquid air was then taken, but in this case, owing to the much greater conductivity which was obtained, a set of sulphur condensers was connected

in series with the free quadrants. The whole capacity in this case, including quadrants, electrode, condensers, and leading wires, was about 3635 e.s.u. The readings taken with both positive and negative fields are given in Table IV., and the curve corresponding to them is shown in fig. 5 (Pl. XVIII.).

TABLE IV.

Conductivity impressed upon Air at 101 atmospheres by the Alpha Rays from Polonium.

Potential difference applied to measuring system.	Current (rise in volts) with positive field.	Current (rise in volts) with negative field.
Volts.	Rise in volts per min.	Rise in volts per min.
1367	62.2×10^{-2}	58.25×10^{-2}
1069	51.3	50.08
839	44.3	42.84
688	38.5	38.24
562	33.6	33.86
403	28.4	28.64
242	22.73	20.5
79	15.23	15.31
38	11.73	12.34
20.5	9.15	9.75
10.0	4.94	5.06

The curve, it will be seen, is in this case practically of the same form as that obtained with the ionization impressed by the rays upon liquid air, and it would appear that here, too, the form of the curve has its explanation : (1) in the formation of ions in the body of the air by some unknown radiation of a more penetrating nature than alpha rays from the polonium-plate, or by the diffusion of ions from the thin ionized layer close to the one electrode into the space between the two electrodes ; and (2) in the gradual lessening of recombination by the applied fields. As the numbers show, the currents with positive and negative fields, just as in the liquid air experiments, were practically the same. In seeking for an explanation of this result, one must bear in mind the work of Kovarik * and of Dempster † on the mobilities of ions produced by alpha rays in gases at high pressures.

In his paper Kovarik has shown that with the air used in his experiments the mobilities of both kinds of ions varied

* Kovarik, Proc. Roy. Soc. A. vol. lxxxvi. p. 154.

† Dempster, Phys. Rev. vol. xxiv. No. 1, p. 53 (1912).

inversely as the pressure from one to seventy-five atmospheres, and that for the same range of pressures the mobility of the negative ion was about 1.4 times greater than that of the positive. Dempster's results, too, show that at 100 atmospheres the mobility of the negative ion in air was about twice that of the positive ion, but his results indicate that while the mobility of the positive ion varied inversely with the pressure up to 100 atmospheres, the mobility of the negative ion decreased less rapidly as the pressure was increased than it should if it followed the inverse pressure law.

With moist carbon dioxide on the other hand, Kovarik found that the mobilities of positive and negative ions were approximately equal to each other for pressures up to 57 atmospheres, and that the mobilities of both ions decreased with increase of pressure much more rapidly than would be warranted by supposing the inverse pressure law to hold. As the air in the present experiments was obtained from a liquid air compressor and no special pains were taken to dry it, other than passing it through a chamber filled with potassium hydrate, it is possible that the equality in conductivity indicated by the results in Table IV. might, in small part at least, be traceable to the presence of moisture in the air.

It would appear, however, from some work which was done later, and which is described in section VI., that the equality in the conductivity obtained with positive and negative fields in the experiments just described was due in great measure to the particular form given to the apparatus used in making the measurements. For it was found when the apparatus was considerably modified, that results were obtained which clearly pointed to the mobility of the negative ion produced in air at high pressures by alpha rays being considerably greater than that of the positive. In taking the readings given in Table IV. the capacity of the system was 3635 e. s. units, and as the capacity of the system in the liquid air measurements was only 200 it would follow that the conductivity obtained in the air at 101 atmospheres with the highest fields used was about 36 times that obtained with the same field when the ionization was produced in liquid air. This difference was no doubt due to the rapid recombination of the ions which must have taken place in the liquid air. The layer of ionization in the liquid air would be considerably narrower than that in the air at the high pressure, and consequently the tendency to recombination would be very much greater in the case of the former than in that of the latter.

V. *Ionization in Air at Atmospheric Pressure
by Alpha Rays.*

In another set of measurements the polonium-coated plate used in the experiments with the liquid air and with the air at the high pressure described in sections III. and IV., was attached to the end of an electrode provided with a guard-tube and inserted at the centre of a cylindrical copper ionization-chamber about 10 cm. in diameter and about 12 cm. in length. The air in this cylinder was kept at atmospheric pressure, and as the range of the alpha rays from polonium is about 3.8 cm. in air at this pressure it is clear that the dimensions of the receiver were such as to insure the complete absorption of all the alpha radiation emitted by the plate. The electrode was connected as before to the quadrants of the electrometer, and the currents were measured with different fields applied to the region traversed by the rays. Here again it was found necessary to attach a sulphur condenser of high capacity to the quadrant system in order to take the readings conveniently. The total capacity of the measuring system used in this case was 8142 e.s.u.

A set of readings taken with this arrangement both with positive and negative potentials applied to the cylindrical receiver is given in Table V., and the curves corresponding to these are shown in fig. 6 (Pl. XVIII.).

TABLE V.

Ionization produced in air at Atmospheric Pressure by the Alpha Rays from the Polonium.

Potential applied to receiver.	Current (rise in volts) with positive field.	Current (rise in volts) with negative field.
Volts.	Volts per min.	Volts per min.
730	3.71	4.23
538	3.71	4.18
445	3.66	4.23
382	3.76	4.18
213	3.32	3.98
130	3.06	3.55
79	2.71	3.00
38.5	1.96	1.85
20.5	.96	.93
10	.35	.34

Here it will be seen the readings obtained with negative fields were considerably higher than those obtained under corresponding voltages with positive fields. This no doubt arose from the mobility of the positive ion being less than that of the negative. With both fields it will be seen saturation-currents were obtained with potentials of approximately 400 volts applied to the cylinder.

As the capacity of the measuring system was 8142 e.s.u., it will be seen from the readings given in the table that the maximum conductivity in this case was about 16 times greater than the maximum obtained with the complete absorption of the same radiation by air at 101 atmospheres, and consequently about 576 times greater than the greatest conductivity measured when the same radiation was absorbed by liquid air. The general results of these measurements therefore agree with those obtained by Greinacher with the liquids which he used, inasmuch as they show (i.) that it is very much more difficult to obtain saturation-currents with ionization in liquid air by alpha rays than when the ionization was produced by the same radiation in air at ordinary pressure, and (ii.) that the currents obtainable with a given field under ionization by alpha rays are very much less with liquid air than with air at ordinary pressures.

VI. *Mobilities of Ions produced by Alpha Rays in Air at High Pressures.*

In order to clear up if possible the question of the relative mobilities of ions produced by alpha rays in air at high pressures, the apparatus shown in fig. 7 was used.

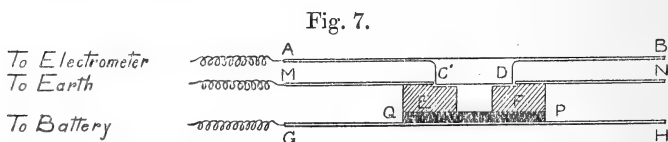

AB was a brass plate about 8 cm. long carrying a boss of the same metal, CD, about 2 cm. in diameter. MN was a second brass plate attached to AB by insulating supports. This plate was provided with a circular opening as shown in the diagram and acted as a guard-plate to the boss CD. A third brass plate GH carried a polonium-coated plate PQ with the coated surface facing the boss CD. EF was a plate of ebonite provided with a circular opening and inserted between the polonium-coated plate PQ and the guard-plate MN and the boss CD. Care was taken in

putting this apparatus together to see that the boss CD did not touch either the plate MN or the ebonite plate EF. The diameter of the opening in EF was 1.06 cm., and the distance between the boss CD and the face of the plate PQ towards it was 1 cm. This apparatus was placed in a strong steel cylinder and air was pumped into the latter until the pressure stood at 120 kilograms per sq. cm. The plate AB was attached to an insulated wire leading through the cylinder and passing on to the quadrants of a Dolezalek electrometer. The plate M was connected directly to the steel cylinder, which was kept joined to earth, and the plate GH was connected by an insulated wire passing through the cylinder to a battery of storage-cells. It should be added that the apparatus was put together initially without the polonium-coated plate PQ in position and was found to insulate perfectly when surrounded with air in the steel cylinder at 120 kilograms per sq. cm. pressure.

With the polonium-coated plate in position one had with this arrangement a layer of highly ionized air close to the plate PQ. Moreover, the field between the plate PQ and the boss CD was a uniform one, and the dimensions of the field through which conduction could take place to the electrode CD were perfectly defined.

When this apparatus was put together and air pumped into the cylinder it was left intact for a period of over five months, and at intervals during this time sets of readings on the current between CD and PQ were taken with series of gradually increasing potentials both positive and negative applied to GH. Throughout the whole of this period the currents for selected fields up to about 750 volts remained practically the same, which showed, since the intensity of the radiation from the polonium must have diminished by over one half in this time, that the current was independent of any variations which took place in the ionization layer.

For such a case as this Rutherford* and Child† have shown that the mobilities of the ions (expressed in electrostatic units) taking part in the conduction may be deduced from the relation

$$k = \frac{32 \cdot \pi \cdot d^3 \cdot i}{9V^2} \dots \dots \dots (1)$$

where i is the current per sq. cm. cross-section, d the distance and V the potential difference between the electrodes.

If practical electromagnetic units be used the mobility is

* Rutherford, *Phys. Rev.* vol. xiii. (6) p. 321 (1901).

† Child, *Phys. Rev.* vol. xii. (3) p. 137 (1901).

given by

$$k = 32 \cdot \pi \cdot \frac{d^3 \cdot i \cdot 10^{11}}{V^2} \text{ cm. a sec. per volt a cm., . . . (2)}$$

where i is expressed in amperes, V is in volts, and d in cm.

If c be the capacity in e.s.u. of the electrode AB together with the leading wires, quadrants, and attached condensers to which it is connected; r the radius of the opening in the ebonite plate EF, x the number of scale-divisions which correspond to a potential of 1 volt applied to the quadrants, and y the number of scale-divisions per min. corresponding to the current between the two electrodes for a given applied field, then i in equation (1) is given by

$$i = \frac{c}{9 \cdot 10^{11}} \cdot \frac{y}{60} \cdot \frac{i}{\pi r^2} \text{ amperes,}$$

and therefore

$$\begin{aligned} k &= \frac{32 \cdot \pi \cdot d^3}{V^2} \cdot 10^{11} \cdot \frac{yc}{x \cdot 60 \cdot 9 \cdot 10^{11} \cdot \pi \cdot r^2} \\ &= \frac{8}{135} \frac{d^3 \cdot y \cdot c}{V^2 \cdot r^2 \cdot x}. \end{aligned}$$

Since with the apparatus used $d=1$ cm. and $r=53$ cm. it follows that k is given by

$$k = .21 \frac{c}{x} \cdot \frac{y}{V^2}.$$

For a selected pressure this relation shows that y should be proportional to V^2 .

One set of readings from a number taken with this apparatus is given in Table VI., and curves drawn from

TABLE VI.

No. of Scale-divisions per volt = $x=400$.					
Positive field.			Negative field.		
Values of y .	V (in volts).	V ² (in volts).	Values of y .	V (in volts).	V ² (in volts).
23	83.1	6,905.6	3.9	80.0	6,400.0
10.7	162.0	26,244.0	11.3	160.0	25,600.0
25.5	242.0	58,564.0	35.2	243.0	59,049.0
51.6	323.0	107,584.0	71.4	328.0	107,584.0
74.5	410.0	168,100.0	104.7	410.0	168,100.0
101.6	490.0	240,100.0	130.0	490.0	240,100.0
147.3	564.0	318,096.0	164.3	565.0	319,225.0
202.8	630.0	396,900.0	220.6	630.0	396,900.0
247.8	732.0	535,824.0	275.8	730.0	532,900.0
292.8	882.0	777,924.0			

them are shown in figs. 8 and 9 (Pl. XVIII.). In both diagrams the values of “ y ” are taken as ordinates, but the values of “ V ” are taken as abscissæ in fig. 8 and the values of V^2 in fig. 9.

TABLE VII.

Mobility of positive ion= k_1 . Mobility of negative ion= k_2 .			
Pressure=116.1 atmospheres.			
Positive ion.		Negative ion.	
$k_1 =$	P. $k_1 =$	$k_2 =$	P. $k_2 =$
0.0005294,	0.06152.	0.0006217,	0.07224.
Ratio $k_2/k_1 = 1.18$.			
Kovarik's Results for pressures up to 75 atmospheres.			
P. $k_1 = 1.346$. P. $k_2 = 1.89$.			

From the numbers given in Table VII. and from the curves in figs. 8 and 9, it will be seen that for potentials up to about 800 volts, the relation between y and V^2 is practically a linear one, and that the mobility of the negative ion is about 18 per cent. greater than that of the positive. This would go to show that one is warranted in applying the Rutherford-Child relation to the present experiments. But the absolute values of the mobilities which have been deduced from the numbers given in Table VII. are much smaller than one should expect them to be if the inverse pressure law applied up to 116 atmospheres.

Kovarik has shown that this law applies in the case of air up to 75 atmospheres, and for positive ions up to this limit he finds $pk_1 = 1.346$ and for the negative $pk_2 = 1.89$. The mobility for the positive ion deduced from these experiments is there only about $1/22$ and that of the negative ion $1/26$ of what one should expect to get if the inverse pressure law held between 75 and 116 atmospheres. If the results obtained be correct it would follow that the inverse pressure law does not apply in this region.

On the other hand, it is just possible that one is not justified in assuming the effective cross-section of the flow of current between the electrodes to be the area of the opening in the ebonite plate EF. There would be a tendency for the ions in passing across the field to diffuse to the walls of this opening, and if such diffusion did occur

the effect would be to reduce the effective area of the opening. This would result in the values of the mobilities deduced as above being smaller than they really should be. However, one would scarcely expect the reduction from values calculated on the basis of the inverse pressure law to be so great as that indicated by the numbers given in Table VII.

A circumstance which seemed to point to diffusion exerting an influence on the readings was a time effect which was observed especially when low fields were used. With fields below 60 volts a centimetre this was particularly marked, and it occurred with both positive and negative fields. Where such fields were applied after the various parts of the apparatus had remained uncharged for some time, a gradual diminution in the intensity of the current was always observed in taking a series of successive readings.

It required about half an hour to elapse after the field was applied before the current reached a limiting value, and the diminution in current amounted to from 12 to 20 per cent. With fields above 60 volts a centimetre the effect gradually disappeared, and when fields of 250 volts a centimetre and higher were applied no diminution in the current was observed. This effect would seem to indicate that the walls of the opening in the ebonite plate gradually became charged by ions diffusing to them. One effect of this action would be to produce a partial neutralization of the field, and this in turn would account for the falling off in the current.

As this effect was absent when the higher fields were applied it is not clear why such small values were obtained for the mobilities. It may be added that the readings given in Table VII. were all taken immediately after the application of the field.

It was the intention of the writers to use the apparatus to determine the mobilities of the ions produced in liquid air by alpha rays, but in view of the small values obtained with it for k_1 and k_2 in air at the particular pressure of 116 atmospheres it seemed advisable to defer these measurements until more extended observations were made on the mobilities of the ions in air at a series of high pressures. The polonium-coated plate used above was of rather small dimensions, but it was all that was available at the time the experiments were made. With a larger plate the effects of diffusion should be lessened.

The experiments made so far show that there should be no great difficulty in finding the mobilities of ions produced in air up to and even beyond 150 atmospheres. The difficulty in determining the mobilities in liquid air will be largely one of getting rid of the formation of air-bubbles in the field

and of preventing the liquid air from becoming contaminated with ice-crystals.

In order to ascertain the mobilities of the ions in liquid air and over as large a range of pressure as possible, and especially to clear up any doubt regarding the results obtained in the present experiments on the mobilities at 116 atmospheres, the investigation is being continued with a polonium-coated plate of larger area.

VII. *On the Existence of a Penetrating Radiation emitted by Polonium.*

In the earlier portion of the paper when dealing with the conductivities represented by the curves shown in figs. 2, 4, and 5, it was suggested in explanation of the bend in the curves that possibly this effect might be due to a small volume ionization in the field due to a penetrating radiation from the polonium. That such a volume ionization did really exist was shown by means of the apparatus given in fig. 7 before it was put together for the experiments described in section VI.

In place of its being constructed as shown in the diagram the ebonite plate was not inserted, but in its place a sheet of finely meshed gauze was fixed parallel to the two plates GH and MN, and about half-way between them. The edges of this gauze sheet were turned down and soldered to the plate GH. The polonium-coated plate was close to the plate GH, and so within the space between it and the gauze.

The apparatus as constructed in this way was placed in the steel receiver, which was then filled up with air to over 100 atmospheres. The distance between the gauze and the plate PQ was about 3.5 millimetres, and as the alpha rays emitted by the polonium could not have a greater range at this high pressure than a fraction of a millimetre, it is clear that these rays could not produce any ionization in the space between the gauze and the plate MN. On applying a potential difference, however, between the gauze and the plate MN a well-marked though small current was obtained which reached saturation with a field of about 20 volts; this current was obtained with positive as well as with negative fields, and with both fields its maximum intensity was the same. This result, combined with the fact that the mobilities of the ions are exceedingly small at the high pressure used, would seem to show that the current had its origin in ionization produced in the space between the gauze and the plate MN by a penetrating radiation from the polonium rather than in ions diffusing through the gauze into this space from the ionized layer close to PQ. The apparatus

was not suitable for testing whether this radiation was magnetically deflectable or not, but in view of the experiments of Chadwick*, which show that gamma rays are produced by alpha rays in certain circumstances, the results would seem to point to the existence of gamma rays accompanying the alpha rays from polonium. The probability of this conclusion being correct is increased when it is remembered that the experiments were made with a layer of polonium which had been deposited on the copper plate PQ about nine months previously. This interval should have been sufficient for any beta-ray product to have died out which with any likelihood might have originally contaminated the polonium deposit.

VIII. *Summary of Results.*

(1) In a number of experiments it has been shown, in agreement with a number of other experimenters, that liquid air when freshly filtered is an extremely good insulator, and that its conductivity in the absence of any ionizing radiation other than that from the earth is much the same as that of ordinary clean air at atmospheric pressure.

(2) The dielectric constant of liquid air was found to be 1.43.

(3) The saturation-current obtained in air at ordinary pressure by the complete absorption of the alpha radiation emitted by a plate coated with polonium, was found to be about 16 times the maximum current obtained with the highest fields used when the radiation was absorbed in air at 101 atmospheres, and about 576 times the maximum current obtained in liquid air when the ionization was produced by the same radiation.

(4) The mobility of the positive ion produced in air at 116 atmospheres by alpha rays was found to be 0.0005294 cm. sec. per volt cm. and that of the negative 0.0006217 cm. sec. per volt cm., the latter being about 1.18 times the former.

(5) Evidence has been found in the course of the investigation of the existence of a penetrating radiation emitted by the layer of polonium which furnished the alpha rays.

In conclusion the authors wish to acknowledge the kindness of Prof. H. A. Dawes and Mr. P. Blackman who assisted in taking readings during the course of the investigation.

The Physical Laboratory,
University of Toronto,
June 1st, 1913.

* Chadwick, Phil. Mag. vol. xxiv. p. 494 (1912); vol. xxv. p. 193 (1913).

LXXV. *The Summation of a Type of a Family of Trigonometric Series.* By I. J. SCHWATT*,

TO find

$$S = \sum_{n=0}^{\infty} \frac{(a + n\gamma)^m \sin^p(\alpha + n\gamma)}{\sqrt{b + nh}} r^n,$$

we may write

$$\begin{aligned} S &= \sum_{\lambda=0}^m \binom{m}{\lambda} a^{m-\lambda} g^\lambda \sum_{n=0}^{\infty} \frac{n^\lambda \sin^p(\alpha + n\gamma)}{\sqrt{b + nh}} r^n \\ &= \sum_{\lambda=0}^m \binom{m}{\lambda} a^{m-\lambda} g^\lambda \left(r \frac{d}{dr} \right)^\lambda \sum_{n=0}^{\infty} \frac{\sin^p(\alpha + n\gamma)}{\sqrt{b + nh}} r^n, \end{aligned} \quad (1)$$

wherein $\left(r \frac{d}{dr} \right)^\lambda$ indicates λ operations, $r \frac{d}{dr}$ each, r and $\frac{d}{dr}$ not being permutable.

Now

$$\sum_{n=0}^{\infty} \frac{\sin^p(\alpha + n\gamma)}{\sqrt{b + nh}} r^n = S_1 = \frac{1}{2^p} \sum_{\mu=0}^p \binom{p}{\mu} \sum_{n=0}^{\infty} \frac{\cos(M + nN)}{\sqrt{b + nh}} r^n,$$

wherein

$$M = (p - 2\mu) \left(\alpha - \frac{\pi}{2} \right) \quad \text{and} \quad N = (p - 2\mu)\gamma.$$

Or

$$S_1 = \frac{1}{2^{p+1}} \sum_{\mu=0}^p \binom{p}{\mu} \left[\sum_{n=0}^{\infty} \frac{(\epsilon^{iN} r)^n}{\sqrt{b + nh}} \epsilon^{iM} + \sum_{n=0}^{\infty} \frac{(\epsilon^{-iN} r)^n}{\sqrt{b + nh}} \epsilon^{-iM} \right]. \quad (2)$$

Let

$$\epsilon^{iN} r = \rho_1, \quad \text{and} \quad \epsilon^{-iN} r = \rho_2, \quad \dots \quad (3)$$

then

$$S_1 = \frac{1}{2^{p+1}} \sum_{\mu=0}^p \binom{p}{\mu} \left[\epsilon^{iM} \sum_{n=0}^{\infty} \frac{\rho_1^n}{\sqrt{b + nh}} + \epsilon^{-iM} \sum_{n=0}^{\infty} \frac{\rho_2^n}{\sqrt{b + nh}} \right]. \quad (4)$$

To obtain

$$\Theta_1 = \sum_{n=0}^{\infty} \frac{\rho_1^n}{\sqrt{b + nh}} = \sum_{n=0}^{\infty} \frac{\chi^{nh}}{\sqrt{b + nh}},$$

wherein $\rho_1 = \chi^h$, we define

$$f(n) = \frac{\chi^n}{\sqrt{b + n}} \sum_{\kappa=1}^h \Theta_\kappa^h,$$

wherein Θ_κ is one of the h h th roots of unity.

* Communicated by the Author.

Then since

$$\sum_{\kappa=1}^h \Theta_{\kappa}^n = 0, \quad \text{when } n \neq 0 \pmod{h},$$

and

$$\sum_{\kappa=1}^h \Theta_{\kappa}^n = h, \quad \text{when } n = 0 \pmod{h},$$

$$\sum_{n=0}^{\infty} \frac{\chi_n}{b+n} \sum_{\kappa=1}^h \Theta_{\kappa}^n = h \sum_{n=0}^{\infty} \frac{\chi^{nh}}{b+nh} = h \mathfrak{S}_1.$$

Adding $\sum_{n=0}^{\infty} f(n)$ by columns we obtain

$$\begin{aligned} h \mathfrak{S}_1 &= \sum_{\kappa=1}^h \sum_{n=0}^{\infty} \frac{(\Theta_{\kappa} \chi)^n}{b+n} \\ &= \sum_{\kappa=1}^h \frac{1}{(\Theta_{\kappa} \chi)^b} \sum_{n=0}^{\infty} \frac{(\Theta_{\kappa} \chi)^{b+n}}{b+n} \\ &= \sum_{\kappa=1}^h \frac{1}{(\Theta_{\kappa} \chi)^b} \left[\epsilon^{\Theta_{\kappa} \chi} - \sum_{n=0}^{b-1} \frac{(\Theta_{\kappa} \chi)^n}{n} \right] \\ &= \frac{1}{h \chi^b} \left[\sum_{\kappa=1}^h \frac{\epsilon^{\Theta_{\kappa} \chi}}{\Theta_{\kappa}^b} - \sum_{n=0}^{b-1} \frac{\chi^n}{n} \sum_{\kappa=1}^h \Theta_{\kappa}^{n-b} \right]. \quad \dots (5) \end{aligned}$$

Now

$$\sum_{\kappa=1}^h \Theta_{\kappa}^{n-b} = 0, \quad \text{when } n-b \text{ or } b-n \neq 0 \pmod{h},$$

and

$$\sum_{\kappa=1}^h \Theta_{\kappa}^{n-b} = h, \quad \text{when } n-b \text{ or } b-n = 0 \pmod{h}.$$

We must therefore consider only such values of n as will make $b-n = th$.

We then have

$$\text{for } n = 0, \quad t = \frac{b}{h}, \quad \text{and for } n = b-1, \quad t = \frac{1}{h}.$$

Writing q for the integral value of $\frac{b}{h}$,

$$\mathfrak{S}_1 = \frac{1}{h \rho_1^{b/h}} \left[\sum_{\kappa=1}^h \frac{\epsilon^{\Theta_{\kappa} \rho_1^{b/h}}}{\Theta_{\kappa}^b} - h \sum_{n=1}^q \frac{\rho_1^{b-nh}}{b-nh} \right]. \quad \dots (6)$$

A similar form is obtained for

$$\mathfrak{S}_2 = \sum_{n=0}^{\infty} \frac{\rho_2^n}{b + nh},$$

and we have

$$\begin{aligned} S_1 = & \frac{1}{2^{p+1}} \sum_{\mu=0}^p \binom{p}{\mu} \left[\epsilon^{iM} \frac{1}{h \rho_1^{b/h}} \left\{ \sum_{\kappa=1}^h \frac{\epsilon^{\Theta_{\kappa} \rho_1^{1/h}}}{\Theta_{\kappa}^b} - h \sum_{\kappa=1}^q \frac{\rho_1^{b/h}}{b - \kappa h} \right\} \right. \\ & \left. + \epsilon^{-iM} \frac{1}{h \rho_2^{b/h}} \left\{ \sum_{\kappa=1}^h \frac{\epsilon^{\Theta_{\kappa} \rho_2^{1/h}}}{\Theta_{\kappa}^b} - h \sum_{\kappa=1}^q \frac{\rho_2^{b/h}}{b - \kappa h} \right\} \right]. \quad (7) \end{aligned}$$

Now, let $r^{1/h} = y$, then

$$r \frac{d}{dr} = \frac{1}{h} \left(y \frac{d}{dy} \right),$$

and

$$\begin{aligned} \left(r \frac{d}{dr} \right)^{\lambda} f(r) &= \frac{1}{h^{\lambda}} \left(y \frac{d}{dy} \right)^{\lambda} f(y) \\ &= \frac{1}{h^{\lambda}} \sum_{\zeta=1}^{\lambda} \frac{1}{\zeta} \sum_{\eta=0}^{\zeta-1} (-1)^{\eta} \binom{\zeta}{\eta} (\zeta - \eta)^{\lambda} y^{\zeta} \frac{d^{\zeta}}{dy^{\zeta}} f(y). \end{aligned}$$

Replacing ρ_1 and ρ_2 in (7) by their values from (3), in terms of y , (1) becomes

$$\begin{aligned} S = & \sum_{\lambda=0}^m \binom{m}{\lambda} a^{m-\lambda} g^{\lambda} \frac{1}{h^{\lambda+1} 2^{p+1}} \sum_{\mu=0}^p \binom{p}{\mu} \left(y \frac{d}{dy} \right)^{\lambda} \left[\frac{\epsilon^{iM}}{\epsilon^{\frac{i b N}{h}} y^b} \left\{ \sum_{\kappa=1}^h \frac{\epsilon^{\Theta_{\kappa} y \epsilon^{\frac{i N}{h}}}}{\Theta_{\kappa}^b} \right. \right. \\ & \left. \left. - h \sum_{\kappa=1}^q \frac{\epsilon^{\frac{i(b-\kappa h) N}{h}}}{b - \kappa h} y^{b-\kappa h} \right\} + \frac{\epsilon^{-iM}}{\epsilon^{\frac{-i b N}{h}} y^b} \left\{ \sum_{\kappa=1}^h \frac{\epsilon^{\Theta_{\kappa} y \epsilon^{\frac{-i N}{h}}}}{\Theta_{\kappa}^b} - h \sum_{\kappa=1}^q \frac{\epsilon^{\frac{-i(b-\kappa h) N}{h}}}{b - \kappa h} y^{b-\kappa h} \right\} \right], \end{aligned} \quad (8)$$

$$= \sum_{\lambda=0}^m \binom{m}{\lambda} a^{m-\lambda} g^{\lambda} \frac{1}{h^{\lambda+1} 2^{p+1}} \sum_{\mu=0}^p \binom{p}{\mu} \sum_{\zeta=1}^{\lambda} \frac{1}{\zeta} \sum_{\eta=0}^{\zeta-1} (-1)^{\eta} \binom{\zeta}{\eta} (\zeta - \eta)^{\lambda} y^{\zeta} \frac{d^{\zeta}}{dy^{\zeta}} [P_y],$$

wherein P_y stands for the expression within the square brackets in (8).

Carrying out the indicated differentiation and separating

in the expression obtained the real from the imaginary part, we finally have

$$S = \sum_{\lambda=0}^m \binom{m}{\lambda} a^{m-\lambda} g^\lambda \frac{1}{h^{\lambda+1} 2^{p+1}} \sum_{\mu=0}^p \binom{p}{\mu} \sum_{\xi=1}^{\lambda} \frac{1}{\xi} \sum_{\eta=0}^{\xi-1} (-1)^\eta \binom{\xi}{\eta} (\xi - \eta)^\lambda$$

$$\sum_{\beta=0}^{\xi} \binom{\xi}{\beta} (-1)^{\xi-\beta} \frac{1}{r^{\frac{b-\beta}{h}}} \left(b + \xi - \beta - 1 \right) \binom{\xi-\beta}{\xi-\beta} \left[\sum_{\kappa=1}^h \left\{ \epsilon^{r^{1/h} \cos \frac{2\kappa\pi + N}{h}} \cos \right. \right.$$

$$\left. \left[(b-\beta) \frac{2\kappa\pi - N}{h} + M + r^{1/h} \sin \frac{2\kappa\pi + N}{h} \right] + \epsilon^{r^{1/h} \cos \frac{2\kappa\pi - N}{h}} \cos \right.$$

$$\left. \left. \left[(b-\beta) \frac{2\kappa\pi + N}{h} - M + r^{1/h} \sin \frac{2\kappa\pi - N}{h} \right] \right\} - 2h \sum_{\kappa=1}^q \frac{\cos (M - \kappa N)}{b - \kappa h - \beta} r^{\frac{b - \kappa h - \beta}{h}} \right].$$

University of Pennsylvania,
Philadelphia.

LXXVI. *A Method for the Summation of a Type of Infinite Series.* By I. J. SCHWATT*.

TO find

$$S = \sum_{n=0}^{\infty} \frac{(\pm 1)^{n_r m}}{\prod_{m=1}^p (tn + m)}, \quad r > 0.$$

Now

$$\frac{1}{\prod_{m=1}^p (tn + m)} = \frac{1}{p-1} \sum_{\kappa=0}^{p-1} (-1)^\kappa \binom{p-1}{\kappa} \frac{1}{tn + \kappa + 1}. \quad (1)$$

Let $r = x^t$, then

$$S = \frac{1}{p-1} \sum_{\kappa=0}^{p-1} (-1)^\kappa \binom{p-1}{\kappa} \frac{1}{x^{\kappa+1}} S_\kappa,$$

wherein

$$S_\kappa = \sum_{n=0}^{\infty} (\pm 1)^n \frac{x^{tn + \kappa + 1}}{tn + \kappa + 1}$$

$$= \int_0^x \frac{x^\kappa}{1 \mp x^t} dx + C_\kappa. \quad \dots \dots (2)$$

Since κ can be either greater or less than t , we can write

* Communicated by the Author.

$t\alpha + \beta$ for κ ($\beta=0, 1, 2, \dots, t-1$), and have

$$S'_\kappa = S'_{t\alpha+\beta} = \int \frac{x^{t\alpha+\beta}}{1-x^t} dx$$

$$= - \int \sum_{\gamma=0}^{\alpha-1} x^{t\gamma+\beta} dx + \int \frac{x^\beta}{1-x^t} dx + C'_\kappa \dots \dots \dots (3)$$

and

$$S''_\kappa = S''_{t\alpha+\beta} = \int \frac{x^{t\alpha+\beta}}{1+x^t} dx$$

$$= \int \sum_{\gamma=0}^{\alpha-1} (-1)^{\alpha+\gamma-1} x^{t\gamma+\beta} dx + (-1)^\alpha \int \frac{x^\beta}{1+x^t} dx + C''_\kappa \dots \dots (4)$$

Now

$$\frac{x^\beta}{1-x^t} = -\frac{1}{t} \left[\frac{1}{x-1} + \frac{\frac{1}{2}(-1)^\beta [1+(-1)^t]}{x+1} \right.$$

$$+ \sum_{\lambda=1}^{\frac{t-2}{2} \text{ or } \frac{t-1}{2}} \frac{\left(2x - 2 \cos \frac{2\lambda\pi}{t}\right) \cos \frac{2\lambda(\beta+1)\pi}{t}}{x^2 - 2x \cos \frac{2\lambda\pi}{t} + 1}$$

$$\left. + \sum_{\lambda=1}^{\frac{t-2}{2} \text{ or } \frac{t-1}{2}} \frac{2 \cos \frac{2\lambda\pi}{t} \cos \frac{2\lambda(\beta+1)\pi}{t} - 2 \cos \frac{2\lambda\beta\pi}{t}}{x^2 - 2x \cos \frac{2\lambda\pi}{t} + 1} \right]. \quad (5)$$

By means of (5) we obtain from (3)

$$S'_{t\alpha+\beta} = - \sum_{\gamma=0}^{\alpha-1} \frac{x^{t\gamma+\beta+1}}{t\gamma+\beta+1}$$

$$- \frac{1}{t} \left[\log(1-x) + \frac{1}{2}(-1)^\beta [1+(-1)^t] \log(1+x) \right.$$

$$+ \sum_{\lambda=1}^{\frac{t-2}{2} \text{ or } \frac{t-1}{2}} \cos \frac{2\lambda(\beta+1)\pi}{t} \log \left(x^2 - 2x \cos \frac{2\lambda\pi}{t} + 1 \right)$$

$$\left. + \sum_{\lambda=1}^{\frac{t-2}{2} \text{ or } \frac{t-1}{2}} \frac{2 \cos \frac{2\lambda\pi}{t} \cos \frac{2\lambda(\beta+1)\pi}{t} - 2 \cos \frac{2\lambda\beta\pi}{t}}{\sin \frac{2\lambda\pi}{t}} \tan^{-1} \frac{x \sin \frac{2\lambda\pi}{t}}{1-x \cos \frac{2\lambda\pi}{t}} \right] \dots \dots \dots (6)$$

The last summation includes

$$C'_\kappa = -\frac{1}{t} \sum_{\lambda=1}^{\frac{t-2}{2} \text{ or } \frac{t-1}{2}} \left[2 \cos \frac{2\lambda\pi}{t} \cos \frac{2\lambda(\beta+1)\pi}{t} - 2 \cos \frac{2\lambda\beta\pi}{t} \right].$$

We finally obtain for positive values of r

$$\begin{aligned} S = & \frac{1}{t} \sum_{\kappa=0}^{p-1} (-1)^{\kappa+1} \binom{p-1}{\kappa} \frac{1}{r^{\frac{\kappa+1}{t}}} \\ & \times \left\{ \log(1-r^{1/t}) + \frac{1}{2} (-1)^{\kappa-t \left[\frac{\kappa}{t} \right]} [1 + (-1)^t] \log(1+r^{1/t}) \right. \\ & + \sum_{\lambda=1}^{\frac{t-2}{2} \text{ or } \frac{t-1}{2}} \cos \frac{2\lambda \left(\kappa+1-t \left[\frac{\kappa}{t} \right] \right) \pi}{t} \log \left(r^{2/t} - 2r^{1/t} \cos \frac{2\lambda\pi}{t} + 1 \right) \\ & + \frac{\sum_{\lambda=1}^{\frac{t-2}{2} \text{ or } \frac{t-1}{2}} 2 \cos \frac{2\lambda\pi}{t} \cos 2\lambda \left(\kappa+1-t \left[\frac{\kappa}{t} \right] \right) \pi - 2 \cos \frac{2\lambda \left(\kappa-t \left[\frac{\kappa}{t} \right] \right) \pi}{t}}{\sin \frac{2\lambda\pi}{t}} \\ & \left. \times \tan^{-1} \frac{r^{1/t} \sin \frac{2\lambda\pi}{t}}{1 - r^{1/t} \cos \frac{2\lambda\pi}{t}} \right\} \\ & - \frac{1}{p-1} \sum_{\kappa=t}^{p-1} (-1)^\kappa \binom{p-1}{\kappa} \sum_{\gamma=0}^{\left[\frac{\kappa}{t} \right] - 1} \frac{r^{\gamma - \left[\frac{\kappa}{t} \right]}}{t \left(\gamma - \left[\frac{\kappa}{t} \right] \right) + \kappa + 1}, \dots \quad (7) \end{aligned}$$

wherein $\left[\frac{\kappa}{t} \right]$ is the greatest integer in $\frac{\kappa}{t}$.

By means of

$$\begin{aligned} \frac{x^\beta}{1+x^t} = & \frac{1}{t} \left[\sum_{\lambda=1}^{\frac{t-1}{2} \text{ or } \frac{t}{2}} \frac{2 \cos \left[(2\lambda+1) \frac{\beta\pi}{t} \right] - 2x \cos (2\lambda+1) \frac{\beta+1}{t} \pi}{x^2 - 2x \cos \left[(2\lambda+1) \frac{\pi}{t} \right] + 1} \right. \\ & \left. + \frac{\frac{1}{2} (-1)^{\beta-1} [1 - (-1)^t]}{x+1} \right] \end{aligned}$$

we obtain from (4) for negative values of r an expression for S similar to (7).

The following example will illustrate the method of work.

To find

$$S = \sum_{n=0}^{\infty} \frac{r^n}{\prod_{m=1}^5 (4n+m)}$$

Then

$$S = \frac{1}{\lfloor 4} \sum_{\kappa=0}^4 (-1)^\kappa \binom{4}{\kappa} \sum_{n=0}^{\infty} \frac{r^n}{4n+\kappa+1}$$

Let $r = x^4$, then

$$S = \frac{1}{\lfloor 4} \sum_{\kappa=0}^4 (-1)^\kappa \binom{4}{\kappa} \frac{1}{x^{\kappa+1}} S_\kappa, \dots \dots (1)$$

wherein

$$S_\kappa = \sum_{n=0}^{\infty} \frac{x^{4n+\kappa+1}}{4n+\kappa+1} = \int \frac{x^\kappa}{1-x^4} dx + C_\kappa$$

We have

$$S_0 = \frac{1}{2} \tan^{-1} x + \frac{1}{4} \log \frac{1+x}{1-x},$$

$$S_1 = \frac{1}{4} \log \frac{1+x^2}{1-x^2},$$

$$S_2 = \frac{1}{4} \log \frac{1+x}{1-x} - \frac{1}{2} \tan^{-1} x,$$

$$S_3 = \frac{1}{4} \log (1-x^4),$$

$$S_4 = \frac{1}{2} \tan^{-1} x + \frac{1}{4} \log \frac{1+x}{1-x} - x.$$

By means of these results (1) becomes, after replacing x by $r^{1/4}$,

$$S = \frac{1}{\lfloor 4} \left[\frac{r-6r^{1/2}+1}{2r} \frac{\tan^{-1} r^{1/4}}{r^{1/4}} + \frac{r+6r^{1/2}+1}{4r^{5/4}} \log \frac{1+r^{1/4}}{1-r^{1/4}} - \frac{1+r^{1/2}}{r} \log (1+r^{1/2}) - \frac{1-r^{1/2}}{r} \log (1-r^{1/2}) - \frac{1}{r} \right]. \quad (2)$$

If
$$S = \sum_{n=0}^{\infty} \frac{(-1)^n r^n}{\prod_{m=1}^5 (4n+m)}, \quad r > 0,$$

$$S = \frac{1}{\lfloor 4} \sum_{\kappa=0}^4 (-1)^\kappa \binom{4}{\kappa} \frac{1}{x^{\kappa+1}} \sum_{n=0}^{\infty} (-1)^n \frac{x^{4n+\kappa+1}}{4n+\kappa+1}, \quad (3)$$

wherein $x = r^{1/4}$.

Designating the second summation by S_k , we obtain

$$S_0 = \frac{1}{4\sqrt{2}} \left[\log \frac{x^2 + x\sqrt{2} + 1}{x^2 - x\sqrt{2} + 1} + 2 \tan^{-1} \frac{x\sqrt{2}}{1 - x^2} \right],$$

$$S_1 = \frac{1}{2} \tan^{-1} x^2,$$

$$S_2 = \frac{1}{4\sqrt{2}} \left[-\log \frac{x^2 + x\sqrt{2} + 1}{x^2 - x\sqrt{2} + 1} + 2 \tan^{-1} \frac{x\sqrt{2}}{1 - x^2} \right],$$

$$S_3 = \frac{1}{4} \log (1 + x^4),$$

$$S_4 = x - \frac{1}{4\sqrt{2}} \left[\log \frac{x^2 + x\sqrt{2} + 1}{x^2 - x\sqrt{2} + 1} + 2 \tan^{-1} \frac{x\sqrt{2}}{1 - x^2} \right].$$

By means of these results we obtain

$$S = \frac{1}{4} \left[\frac{\sqrt{2}}{4r^{5/4}} (r + 6r^{1/2} - 1) \tan^{-1} \frac{r^{1/4}\sqrt{2}}{1 - r^{1/2}} - \frac{2}{r^{1/2}} \tan^{-1} r^{1/2} \right. \\ \left. + \frac{\sqrt{2}}{8r^{5/4}} (r - 6r^{1/2} - 1) \log \frac{r^{1/2} + r^{1/4}\sqrt{2} + 1}{r^{1/2} - r^{1/4}\sqrt{2} + 1} - \frac{1}{r} \log (1 + r) + \frac{1}{r} \right].$$

University of Pennsylvania,
Philadelphia, U.S.A.

LXXVII. *Low Potential Discharges in High Vacua.*

By F. HORTON, *D.Sc., M.A.**

IN the 'Proceedings' of the Royal Society (No. A. 607, 1913) Professor Strutt has described an interesting investigation into the origin of a peculiar form of low potential discharge produced in high vacua by the application of a magnetic field. With an apparatus in which the electrodes were two coaxial cylinders, and the gas pressure very low, Professor Strutt found that a difference of potential of many thousands of volts can be applied without a discharge passing, but that if a magnetic field parallel to the axis of the cylinders is created, a luminous discharge occurs with a potential difference of 300 or 400 volts.

An effect of a similar nature to that observed by Professor Strutt is obtained when the negative discharge from a

* Communicated by the Author.

glowing metal, or other active cathode, is subjected to a magnetic force acting in a direction at right angles to that of the electric field. In investigating the ionization produced by heated substances, the writer has occasionally tested the effect of a magnetic field upon the negative emission with different gas pressures in the discharge-tube. The apparatus used has been described in a recent paper*. The cathode was a strip of platinum foil about 2 mm. wide and 2 cm. long, which was covered with the material to be tested, and heated electrically. This was situated midway between two parallel plates, placed 1 cm. apart, which together formed the anode. The magnetic field was applied so that its direction was parallel to the planes of the strip and plates, and at right angles, therefore, to the direction of the electric field. It was found that the effect of a magnetic field upon the current depended not only upon its magnitude, but also upon the gas pressure in the apparatus, and the applied potential difference between the electrodes. At certain pressures and with a large potential difference the application of a weak magnetic field increased the current across the tube. If then, the gas pressure were kept constant and the voltage lowered, a point was reached where the magnetic force had no effect, and on still further decreasing the voltage, the current through the discharge-tube was reduced when the magnetic field was applied. The following numbers, which were obtained with a thorium oxide cathode, will serve to illustrate this. Instead of giving the actual values of the currents through the discharge-tube, the table contains the percentage increase or decrease of the current produced by applying the magnetic force.

Pressure mm.	Effect of the application of the magnetic field upon the current.				
	-220 volts.	-40 volts.	-30 volts	-10 volts.	-2 volts.
1.390	Increased 10 per cent.	Decreased 6 per cent.			
.191	Increased 58 per cent.	Increased 2 per cent.		Decreased 32 per cent.	Decreased 62 per cent.
.015	Increased 12 per cent.	No effect.	Decreased 4 per cent.	Decreased 39 per cent.	Decreased 75 per cent.
.002	No effect.	Decreased 2 per cent.	Decreased 8 per cent.	Decreased 44 per cent.	

* Proc. Roy. Soc. A. vol. lxxxviii. p. 117 (1913).

The effect was not very fully investigated, for it seemed to be readily explained on the theory of ionization by collision. Let us first imagine the experiment to be performed in a perfect vacuum where there are no gas molecules to interfere with the motion of the electrons. In the absence of the magnetic field, the electrons from the cathode go normally outwards towards the anodes. When, however, the magnetic force acts, the electrons are deflected from their initial paths, those from one side of the heated strip being bent upwards and those from the other side downwards. The curvature of the paths of the electrons can be increased by increasing the magnetic field until they are so curled up that none reach the anodes, and thus when the magnetic field reaches a certain value (the other conditions being constant) there is a more or less sudden drop in the current across the tube. The same result may also be obtained by keeping the applied magnetic force constant and gradually reducing the potential difference—this being the procedure adopted by Sir J. J. Thomson in his determinations of the specific charge of the ions produced by ultra-violet light and by an incandescent carbon filament*. If, however, gas is present in the discharge-tube, the electrons from the glowing cathode collide with the gaseous molecules, and if they collide with sufficient energy, new ions will be produced by these collisions. If the gas pressure in the apparatus is so low that the mean free path of the electrons is about equal to the distance between the electrodes, the number of collisions will be comparatively few, but when the magnetic field is created the paths of the electrons are lengthened, and the number of collisions that each of the initial electrons experiences is consequently increased. If the applied potential difference is great enough to give the electrons from the cathode sufficient velocity to ionize the molecules with which they collide, an increased ionization is produced when the magnetic field is established, and consequently an increase occurs in the current through the tube. If, however, the gas pressure is exceedingly low, so that the mean free path of the electrons is much larger than the distance between the electrodes, the curved paths produced by the magnetic field may not lead to many more collisions, and the creation of the magnetic field will therefore have no effect upon the current. This accounts for the absence of effect recorded in the above table with a gas pressure of $\cdot 002$ mm. and a potential difference of 220 volts. It will be seen that at this same pressure but with -40 volts, the magnetic field

* *Phil. Mag.* [5] vol. *xlvi*. p. 547 (1899).

slightly decreases the current, showing that some of the electrons from the cathode do not reach the anode when the magnetic field is established. At a pressure of $\cdot 015$ mm. with this voltage (-40 volts) the magnetic field has no effect; evidently the decrease due to some of the electrons from the cathode not reaching the anode is now just balanced by the extra ionization produced by collisions in the magnetic field. This extra ionization is great enough at the higher pressure of $\cdot 191$ mm. to cause an increase in the current between the electrodes. At a pressure of $1\cdot 39$ mm. the mean free path of the electrons is so small that they do not acquire sufficient velocity under the potential difference of 40 volts to ionize the molecules with which they collide, but it will be seen from the table that with a potential difference of 220 volts this phenomenon again occurs.

We thus see that in order to obtain an increased current on establishing a magnetic field in this experiment, it is necessary to have the conditions of gas pressure and potential difference suitable for the production of ionization by collision; also the magnetic field must not be too strong, otherwise no effect, or even a diminution in the current, may be produced. The result obtained will also depend upon the distance between the electrodes.

An arrangement of coaxial cylinders with a magnetic force parallel to the axis, as used by Professor Strutt, gives a more simple method of investigating this phenomenon, for complications are introduced when small parallel plates are used, but one would expect the discharge in Professor Strutt's experiment to vary with the gas pressure, the potential difference, the magnetic force, and the distance between the electrodes in the same general manner as the current in the experiments described above.

The theory adopted by Professor Strutt to explain his results has been criticised by Professor Townsend in the October number of the *Philosophical Magazine*. It will be seen that the explanation which the writer found accounted for the results of his experiments is similar to that given by Professor Townsend, and depends upon the fact that the lengthened path in a magnetic field gives an electron a greater opportunity of producing ionization by collision, because it meets with more molecules.

The Cavendish Laboratory,
Cambridge.

LXXVIII. *Line Spectrum from Uncharged Molecules.*

By CLEMENT D. CHILD*.

THERE has been much discussion as to whether line spectra are produced by positive ions, or by the molecules which result from the recombination of positive and negative ions. Some experiments recently performed by myself appear to prove that the spectrum of the mercury arc comes from recombined molecules. These experiments are described in the following paragraphs.

Description of Experiments.—When a tube containing a mercury arc in a vacuum is connected with a condensing chamber as in fig. 1, the stream of vapour flowing from the

Fig. 1.

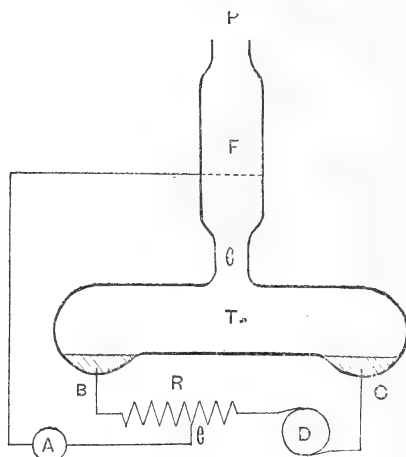

arc is luminous and gives a line spectrum. As far as could be determined with the apparatus at my command, the same lines are shown in the spectrum of this vapour as in that of the arc itself, although the relative intensity of the lines in the two spectra is somewhat different.

In the following experiment the arc was placed in series with a dynamo D, and a resistance R. There was a tube opening into T and connecting at P with a Gaede pump and a drying-bath. In this was a piece of wire gauze F, filling the cross-section of the tube and connecting to the resistance R at a movable point e, so that it could be given any desired potential with respect to the arc. The

* Communicated by the Author.

connexions to the dynamo could be reversed, so that F could be charged either positively or negatively.

In the tube in which measurements were made, the diameter of the opening at *c* was 0.8 cm. and at F was 2.8 cm. The distance from F to the middle of T was 14 cm. The gauze had 5.6 wires per cm. For starting the arc, a tube (not shown in the diagram) extended from C into a mercury cup which could be raised and lowered so as to cause the mercury in C to make and break connexion with that in B.

If the arc is started in such a tube, the luminosity gradually passes up towards F. If F is charged positively to 20 or 30 volts above the potential of the middle of the arc at the time that the luminous vapour begins to pass *c*, a discharge passes to F and striations appear below F. There is then a non-luminous region above *c* corresponding to the dark space near the cathode in an ordinary vacuum discharge. As the luminous vapour rises, the striations rise and disappear as they come to F. *When the last one disappears, the region between F and c is dark when F is charged and luminous when F is not charged.*

If the potential difference between F and the middle of the arc is at this time more than 15 or 20 volts, there is an increase in brightness at *c*. If the potential difference is somewhat smaller than this, the luminosity between F and *c* will still be destroyed but there will be no increase in brightness at *c*. It is this latter condition which gives us the most knowledge concerning the nature of the light from the vapour, and will be discussed in the following paragraphs.

It should be noted that while it is not difficult to secure the right conditions for this experiment, it is difficult to maintain them for any length of time. As the tube becomes heated, greater quantities of vapour pass into the condensing chamber and the region becomes more luminous. If at such a time F is charged to 8 or 10 volts, the light is not all destroyed. If it is charged to more than this, the luminosity is increased instead of being diminished. This increase in light is no doubt the result of ionization between F and *c*, which is caused by the increase in the electric field, as is shown by the increase in the conductivity of the vapour. In previous work performed by myself this region was examined while in such a condition, and as a result I came to the erroneous conclusion that the luminosity could not be destroyed by an electric field*.

* Phys. Rev. xxii. p. 221 (1906).

When F is charged negatively to about 100 volts there is a non-luminous layer extending from F for about 1 mm., but the remainder of the region above *c* is not affected by a negative charge on F. It seemed surprising that the dark space should extend for so short a distance. An arrangement was therefore made which was somewhat different from that shown in the diagram, so that a movable exploring wire could be introduced between F and *c*. It was then found that when F was charged negatively, approximately all of the drop in the potential between F and *c* occurred within a millimetre of F.

The large drop near the electrode was undoubtedly due to the fact that the current to F was being carried by the comparatively slow-moving positive ions. Such a drop occurs when current is carried by one kind of ions only, unless the ions move very rapidly or the current is exceedingly small. It is, therefore, true that in this case also there is no luminosity where there is an electric field.

Light not caused by Chemical Action.—The fact that the luminosity in the region above the arc can be destroyed under certain conditions by an electric field, shows that it cannot be due to chemical action; for an electric field would not stop changes of such a character. Moreover, so far as we know, there is no opportunity for chemical action. All the gases aside from mercury vapour are carried beyond the point where the mercury condenses by the first flow of the vapour from the arc, so that nothing is left in the region where the light appears except such vapour.

As far as could be discovered the phenomenon did not depend in any way on the purity of the mercury; and the spectrum of the light showed no lines except those due to the mercury.

Light not caused by Ionization.—The fact that the light is destroyed by an electric field shows that it is caused by the presence of ions. The vibrations of molecules which produce light are caused by some shock, such as that which occurs when the molecules are broken into ions, or when the ions recombine into molecules. Let us first consider the possibility that the vibrations are started at the time when the ionization occurs. The ionization must occur either in the arc or in the region above it. If the ions are formed in the arc and the vibrations are started at that time, they must continue while the ions move through the luminous region.

This region often extends for 20 or 30 cm. above the arc. From measurements of the Hall effect, Stark* concluded that

* *Phys. Zeit.* iv. p. 440 (1903).

the velocity of the ions when passing from the arc to the condensing chamber was approximately 28,000 cm. per sec. Since the velocity of the ions must decrease as they move up into the condensing chamber, it must take at least 0.001 sec. for the ions to move from the arc to the limit of the luminous region. During this time there would be 5×10^{11} vibrations of the ion. It is highly improbable that an ion will continue to give out energy through so many vibrations and at the end of that time have enough energy left to produce vibrations which affect the eye.

Again, if the light came from ions which are formed in the arc, it would seem reasonable to expect that the light might be concentrated by an electric field. Such a field could move the vibrating ions, but could not destroy the vibrations. If it moved the ions towards the arc, for example, we would have the light which was previously spread through the condensing chamber concentrated in the region near the arc. Nothing of this sort was found to occur.

Neither is it possible that the light is due to ionization occurring in the region above the arc. The first reason for this statement is that there is no known cause for the production of ions in this region. The light cannot be due to ions which are produced by an electric field, for the region is distinctly visible when F is at the same potential as the middle of the arc. The luminosity is not caused by any form of radiation from the arc, as was shown in the previous experiment to which reference has been made.

However, there may be some unknown cause for ionization; so that a more important reason for saying that the light is not due to ionization occurring above the arc is that the matter which gives out the light must have been ionized before it reached that region. This is true, since the luminosity can be entirely removed by an electric field under the proper conditions, and an electric field cannot move matter which is not ionized. It must be that the light comes from matter which is ionized in the arc but is set in vibration in the region above it.

Light caused by Recombination.—As far as we know, the only cause which can produce vibrations in matter which has been previously ionized is the recombination of the positive and negative ions. The assumption that this is the cause of the light in the mercury vapour would explain all of the observations satisfactorily. When either kind of the ions is removed by an electric field there can be no recombination, and the luminosity is destroyed. Again, the field cannot concentrate both kinds of ions in the same

region. If it pushed one kind back towards the arc, it would draw the other away from it. Hence the addition of the field does not intensify the light in any region.

It might seem possible that there is a spontaneous kind of ionization occurring immediately after the recombination, that some of the molecules are so violently agitated by the recombination that they fly apart again into ions and that this ionization is the cause of the light. But if the electron gets so far from the positive ion as to have no effect on it, there is the same energy given to the positive and negative parts in separating as they gave up in coming together, and yet during this action vibrations are started which give out energy in the form of light. This would be a creation of energy. If the electron is not separated, so as to move beyond the sphere of action of the positive ion, the two are still combined and it is not an ion which is vibrating, but a recombined molecule.

Further Experiments on the Luminous Vapour.

The experiment was modified by using two electrodes in the place of F, and by using a magnetic field in the place of an electric one to remove the ions. The wire gauze was removed and two electrodes were put in its place, one on each side of the upper tube. These were part of a cylinder cut in such a way as to fill the sides of the tube and compel the vapour to pass between them. A cross-section of the tube and the electrodes is shown in fig. 2. They were

Fig. 2.

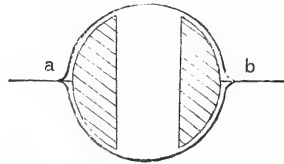

connected by the wires at *a* and *b* to a separate E.M.F. The length of these electrodes was 5 cm., and the distance between them was approximately 7 mm. They were made of copper. Although this forms an amalgam with the mercury, it was used in order not to distort the magnetic field which was used in part of the experiment.

When the electrodes were connected with an E.M.F. distinct from the arc, there was a dark region near the negative electrode. When the potential difference between

the electrodes was 140 volts, the dark space was about 1 mm. thick at the bottom of the electrode and somewhat more than this at the top. No doubt the reason that this dark space did not extend more than this was that the drop in potential was all in the immediate neighbourhood of the negative electrode, as in one of the previous experiments. The dark space extends somewhat further at the top of the electrode, since there are fewer ions there, and their electrostatic effect is not so marked.

A magnetic field was then placed perpendicular to the line joining the electrodes and also to the direction in which the vapour was moving. When the strength of this field was 5560 lines per sq. cm., there was a great diminution in the amount of light beyond the electrodes. The ions were apparently forced out of the region by the magnetic field, leaving the vapour non-luminous. With the magnetic field the lessening of the brightness did not seem to occur at one electrode more than at the other.

Investigation was also made on the conductivity of the vapour above F, and while it confirmed what has been said about the electrical properties of the vapour, it did not appear to give any further knowledge concerning the cause of the light and may be omitted from this discussion.

It was also observed that with the vapour freely rising from the arc, and with a potential difference of more than 15 volts between F and the arc, the luminosity was increased and was changed from a yellow to a green tint. This was found to be due to a strengthening of the green line in the mercury spectrum. I hope to be able to report on this more fully in a later article.

Summary.

The vapour passing from the mercury arc in a vacuum to a condensing chamber is luminous and has a line spectrum similar to the spectrum of the arc. This luminosity can be destroyed by an electric field. It cannot be concentrated at any point and is not due to radiation from the arc. These facts cannot be explained by assuming that the light is due to chemical action nor to ionization of the vapour either in the arc or in the region above it. They can, however, be satisfactorily explained by assuming that the light is caused by the recombination of the ions to form uncharged molecules.

LXXIX. *A Special Case of Gaseous Conduction.*
 By NORMAN CAMPBELL, *Sc.D.**

I. *Theoretical.*

1. **T**HE relation of the current through a gas contained in a parallel plate condenser and uniformly ionized to the electric field acting upon it has been studied by J. J. Thomson, Mie, Seeliger, and Greinacher. Seeman †, in an elaborate series of observations, has shown that the theoretical formulæ are satisfactorily in accordance with experiment when the ionization is produced by X rays. In the circumstances contemplated by the theory and realized in the experiments, the only process which limits the proportion of the saturation current which can be obtained with small fields is that of the recombination of the ions. But even if there were no recombination, another process, diffusion, would make it impossible to obtain the saturation current with infinitely small fields; for the diffusion of the ions involves the possibility that they may travel against the field to the similarly charged, and not to the oppositely charged, electrode. The theory developed hitherto considers only those cases where the effects of diffusion may be neglected compared with those of recombination; some recent experiments, to be described below, seem to show that cases may occur in practice in which the relative importance of the two processes is reversed.

2. Let us consider, then, the equations determining the motion of the ions in a parallel plate condenser, neglecting recombination but taking diffusion into account.

Let the plane of $x=0$ be parallel to the plates and distant l from each of them. Let V be the potential difference between the plates, X the electric intensity, q the number of ions produced in unit time in unit volume, k_1X , k_2X the velocities of the positive and negative ions, D_1 , D_2 their diffusion coefficients, n_1 , n_2 the concentrations of the ions in the gas, i the current density, and I the saturation-current density. The fundamental equations expressed in electrostatic units are :—

$$q = \frac{d}{dx} \left(n_1 k_1 X - D_1 \frac{dn_1}{dx} \right) \quad \dots \dots \dots (1)$$

$$= - \frac{d}{dx} \left(n_2 k_2 X + D_2 \frac{dn_2}{dx} \right) \quad \dots \dots \dots (2)$$

* Communicated by the Author.

† *Ann. d. Phys.* vol. xxxviii. p. 781 (1912); references are given in this paper to the theoretical discussions.

$$\frac{dX}{dx} = 4\pi(n_1 - n_2)e \dots \dots \dots (3)$$

$$i/e = X(n_1k_1 + n_2k_2) - \frac{d}{dx}(D_1n_1 - D_2n_2) \dots \dots (4)$$

with the boundary conditions

$$n_1 = 0 \text{ when } x = l; \quad n_2 = 0 \text{ when } x = -l. \dots (5)$$

I am unable to make any material progress towards a solution unless many simplifying assumptions are made. Let us assume in the first place that $k_1 = k_2$ and $D_1 = D_2$. X must then be a function of even powers of x . Let us now confine our attention to those cases when the current is nearly saturated and assume that in these cases X has the form

$$X = X_0 + 2\pi b x^2, \dots \dots \dots (6)$$

the second term being small compared with the first. We now obtain from (3) and (4)

$$n_1 - n_2 = \frac{bx}{e}, \dots \dots \dots (7)$$

$$n_1 + n_2 = \frac{i + bD}{kXe} \dots \dots \dots (8)$$

Hence from (5)

$$X_0 = \frac{i + bD}{kbl} - 2\pi bl^2. \dots \dots \dots (9)$$

Adding (1) and (2) and putting $x=0$, we get

$$2q = \frac{kbX_0}{e} - \frac{D}{k} \frac{i + bD}{e} \cdot \frac{4\pi b}{X_0^2} \dots \dots \dots (10)$$

In virtue of the assumption that the second term of (6) is always small compared with the first, it appears that we may write approximately

$$2q = \frac{kb}{e} \cdot \frac{i + bD}{kbl} \dots \dots \dots (11)$$

and

$$V = 2X_0l. \dots \dots \dots (12)$$

But

$$I = 2qel. \dots \dots \dots (13)$$

Therefore

$$b = \frac{I-i}{D} \dots \dots \dots (14)$$

and

$$\frac{i}{I} = 1 - \frac{2\lambda}{V}, \dots \dots \dots (15)$$

where

$$\lambda = \frac{D}{k} \dots \dots \dots (16)$$

It is to be observed that the assumptions made are not mutually inconsistent, for (14) shows that in fact b is small when the current is nearly saturated. It is not pretended, however, that the calculation is rigidly justifiable, but it seems to lead to results in accordance with observation. It must be remarked that two conditions must be fulfilled if (15) is to be applicable. In the first place the effects of recombination must be negligible, that is to say, $\alpha n_1 n_2$ must always be small compared with q . If we take the values of $n_1 n_2$ from (7) and (8) and observe that $n_1 n_2$ is a maximum when $x=0$, the necessary condition is found to be that

$$\frac{1}{4} \left(\frac{\alpha}{e} \right) \frac{b^2 l^2}{q e} \text{ is small compared with unity. } \dots (A)$$

In the second place $2\pi b l^2$ must be small compared with X , that is to say, the necessary condition is that

$$\frac{2\pi(I-i)l^3}{DV} \text{ is small compared with unity. } \dots (B)$$

(15), if it is true in any possible experimental conditions, represents rather a remarkable result. For a well-known argument due to Townsend shows that λ is a universal function of the temperature of the gas and the ionic charge.

It is equal to $\frac{P}{N\epsilon}$, where P is the pressure of a gas containing

N molecules per cm.^3 ; it has the dimensions of a potential and the numerical value 0.0248 volt at 16°C . Accordingly, in the circumstances to which (15) applies, i/I should depend only on the potential between the plates and the temperature and should be independent of the pressure or nature of the gas, of intensity of the ionization and of the distance between the plates.

II. *Experimental.*

3. The experiments about to be described were undertaken with the primary object of finding out something about the δ rays emitted from the molecules of a gas when it is ionized. It was thought that information might be obtained by measuring the relation between the current and the field in such circumstances that the potential difference necessary to obtain a saturation current was not large compared with that corresponding to the velocities with which rays are known to be emitted from metals. It may be said at once that this primary object of the experiments has not been attained.

4. The gas was contained in a parallel plate guard-ring condenser. The central portion of the lower plate, which was connected to the measuring apparatus, was circular and 7.5 cm. in diameter; it was separated by a gap of 1 mm. from a guard-ring 2 cm. broad. The distance between the plates was in some experiments 0.9 mm., in others 2.6 mm. The upper plate was pierced by a central hole 3 cm. in diameter; the plates were of brass, but the lower face of the upper plate (including the hole) was covered with aluminium leaf. The gas was ionized either by α rays from a disk covered with polonium or ThC placed in the hole in the upper plate, or by β and γ rays from Ra, or by X rays passing mainly through that hole and through an aluminium window in the gas-tight vessel containing the condenser.

The potential difference between the plates was established by means of a potentiometer and a cell of which the E.M.F. was measured by a Weston Standard Voltmeter. The values of V given below are not simply those given by the potentiometer. There was a volta difference of potential between the plates which could be measured by observing what external potential difference had to be applied to the plates in order to make the current between them zero. The values of V given are those obtained by subtracting from the P.D. given by the potentiometer that necessary to make the current zero.

When α or β rays were used, the current was measured by means of a xylol-alcohol resistance, of which the resistance was within 10 per cent. of 1.2×10^{11} ohms; when X rays were used the current was measured by the ordinary compensation method involving the use of a sliding shutter.

The gases used were air, hydrogen, and carbon dioxide; the last two were evolved from Kipps and all were well dried. It appeared that no alterations in the results were

made by purifying the hydrogen by passing it over charcoal cooled in liquid air.

5. Preliminary experiments with α rays showed that for each gas and for each distance between the plates there was a range of pressure within which the relation between i/I and V was approximately independent of the pressure; and that, further, this relation within this range was approximately the same whatever the gas and whatever the distance between the plates. Accordingly a series of experiments was undertaken in which the whole curve relating i/I to V was not traced, but the values of that ratio were measured for only two values of V (0.1 and 0.2 volt), while the pressure, the nature of the gas, and the distance between the plates was varied*. In all cases i/I appeared independent of the sign of V ; the mean of the values for opposite signs is given in the following tables I.-VI., which show the results obtained. The horizontal lines bound the range over which i/I appears to be independent of the pressure, and the means at the bottom of each table are those taken over this range. I is taken as the value corresponding to $V=40$; within the

TABLE I.

Air; $2l=0.9$ mm. $I/p \sim 1.0 \times 10^{-15}$ amp./cm.².

p (in mm.).	i/I .	
	$V=0.1$ volt.	$V=0.2$ volt.
7	0.39	0.58
33	0.476	0.692
46	0.477	0.709
81	0.485	0.713
122	0.504	0.730
162	0.492	0.727
180	0.500	0.725
202	0.492	0.736
220	0.500	0.730
302	0.474	0.717
374	0.466	0.680
752	0.366	0.558
Mean	0.498	0.730

* It was found almost impossible to get satisfactory measurements when V was less than 0.1 volt.

important range the current was almost perfectly * saturated for such a voltage, but at the higher pressures in air and carbon dioxide, Bragg's "initial recombination" appeared, so that the value attributed to I may be too small; at the very lowest pressures there was some indication of ionization by collision, so that I may be slightly too great.

TABLE II.

Air ; $2l=2.6$ mm. $I/p \sim 3.1 \times 10^{-15}$ amp./cm.².

p (in mm.).	i/I .	
	$V=0.1$ volt.	$V=0.2$ volt.
10	0.445	0.667
36	0.470	0.711
73	0.485	0.720
82	0.475	0.724
96	0.474	0.723
109	0.476	0.719
132	0.485	0.718
178	0.454	0.705
292	0.396	0.647
415	0.310	0.523
520	0.240	0.425
715	0.161	0.294
Mean	0.477	0.719

TABLE III.

Hydrogen ; $2l=0.9$ mm. $I/p \sim 2.3 \times 10^{-16}$ amp./cm.².

p (in mm.).	i/I .	
	$V=0.1$ volt.	$V=0.2$ volt.
178	0.454	0.698
374	0.461	0.710
503	0.463	0.705
765	0.459	0.697
Mean	0.459	0.702

* Changes in the current of less than 1 in 2000 could be detected. I have never been able to saturate any gas to this degree of accuracy, but the current did not increase more than 1 in 1000 when V was increased from 40 to 200.

TABLE IV.

Hydrogen ; $2l=2.6$ mm. $I/p \sim 6.8 \times 10^{-16}$ amp./cm.².

<i>p</i> (in mm.).	<i>i</i> / <i>I</i> .	
	V=0.1 volt.	V=0.2 volt.
92	0.459	0.707
194	0.461	0.706
316	0.455	0.712
460	0.445	0.689
760	0.425	0.687
Mean	0.459	0.708

TABLE V.

Carbon dioxide ; $2l=0.9$ mm. $I/p \sim 1.5 \times 10^{-15}$ amp./cm.².

<i>p</i> (in mm.).	<i>i</i> / <i>I</i> .	
	V=0.1 volt.	V=0.2 volt.
29	0.465	0.698
44	0.477	0.695
53	0.485	0.719
70	0.475	0.687
96	0.479	0.696
126	0.480	0.708
200	0.460	0.689
760	0.214	0.360
Mean	0.474	0.700

TABLE VI.

Carbon dioxide ; $2l=2.6$ mm. $I/p \sim 4.7 \times 10^{-15}$ amp./cm.².

<i>p</i> (in mm.).	<i>i</i> / <i>I</i> .	
	V=0.1 volt.	V=0.2 volt.
10	0.486	0.717
28	0.478	0.709
60	0.477	0.708
108	0.384	0.642
204	0.336	0.630
301	0.242	0.447
439	0.160	0.307
Mean	0.480	0.711

6. The figures in the tables clearly justify the assertion that over a considerable range of pressure, i/I is independent of the pressure for small values of V . It will be observed that within this range the values of i/I are maxima, decreasing either for higher or lower pressures. But the figures may not seem to bear out the statement that these maximum values are independent of l and of the nature of the gas. However, several times in the course of the work it was found that the value of i/I changed suddenly and abnormal values (not recorded in the tables) were found; after a time, especially if the apparatus was taken down and put up again, i/I would return nearly but not quite to its previous value. Further investigation of these changes showed that they took place at the surface of the plates of the condenser; it appears that under certain conditions the electrodes may refuse to absorb all the ions falling on them in small electric fields. The exact circumstances determining the change have not been investigated, but it was found that aluminium, especially if carefully cleaned, was peculiarly subject to the trouble; and that it could be cured completely by covering the surface of the plates with soot. This procedure was adopted in all the later experiments, which showed that the values of i/I obtained previously were all slightly too low and that the difference between them was only due to differences in the condition of the electrodes; when sooted electrodes were used, no difference could be detected between the maximum values of i/I in the different tables.

7. Observations were then made with greater values of V . Variations in the value of i/I were now more difficult to detect because the values were in all cases so nearly 1; but it appeared again that there is a range of pressure in each gas and for each value of l within which the values of i/I are a maximum, independent of the nature of the gas and of l . This range was not quite the same as in the case of the smaller values of V , being displaced towards higher pressures. The following table gives a few typical figures:—

TABLE VII.

Air; $2l=2.6$ mm.

p	60	104	212	353	468	762
$V=4.$ i/I	0.971	0.982	0.988	0.987	0.963	0.921
$V=2.$ i/I	0.958	0.967	0.976	0.977	0.950	0.855

Hydrogen; $l=0.9$ mm.

p	111	291	392	504	741
$V=4.$ i/I	0.987	0.988	0.985	0.987	0.984
$V=2.$ i/I	0.962	0.969	0.975	0.976	0.972

8. These measurements were made with polonium as a source of α rays; no difference could be detected if it was replaced by ThC, or when absorbing sheets were placed between the source and the chamber. Experiments were also made in which X rays were used in place of α rays, the intensity of the rays and their hardness being varied by means of absorbing screens. No dependence of the maximum values of i/I on the nature or the intensity of the rays could be detected*, but the range of pressure over which the maximum values of i/I were obtained extended notably further in the direction of high pressures when X rays were used, especially when V was small. The magnitude of I for a given value of p and l was not very different in the experiments with the different kinds of rays.

9. These results were obtained before the theory of § 2 had been worked out, but it was immediately obvious that they could not be reconciled with the theory of conduction which regards only recombination. According to that theory, i/I is approximately a function of V/V_p , where

$$V_p = 2Il \sqrt{\frac{\alpha}{q} (k_1 + k_2)^{-1}}.$$

(α is the coefficient of recombination.) Now $(k_1 + k_2)^{-1} \propto p$, α increases somewhat with the pressure but is almost independent of the nature of the gas, $I \propto ql$, $q \propto p$. Hence for changes of pressure, V_p should increase with p more rapidly than $p^{3/2}$, for changes of l it should increase as l^2 , for changes in the gas should change as $\frac{q^{1/2}}{k_1 + k_2}$, and for changes of q should change as $q^{1/2}$. The constancy of the relation of i/I to V while these quantities vary over the range observed in these experiments is quite irreconcilable with the view that i/I is determined by V/V_p .

On the other hand, if the experimental conditions can be supposed to be such that the theory leading to (15) is applicable, the identity of the relation of i/I to V for all pressures, gases, and distances between the electrodes and intensities of ionization is at once explained. Moreover, there is quantitative agreement between theory and experiment. In the case of both air and hydrogen it is possible to find a small range of pressure within which i/I has its maximum value for both small and large values of V . The following table gives these values; the figures are the means obtained

* The greatest difference in the value of i/I which could possibly have escaped detection varied from 0.005 when $V > 4$ to 0.015 when $V = 0.1$.

in four specially careful and concordant series of measurements, two in air and two in hydrogen. The second column gives the observed values of i/I , the third those calculated from (15), putting $\lambda=0.0248$, corresponding to 16° , the mean temperature of the experiments.

TABLE VIII.

V.	i/I.	1 - $\frac{2\lambda}{V}$.
40	1.000	0.999
16	0.996	0.997
12	0.994	0.996
8	0.991	0.994
4	0.987	0.988
2	0.976	0.975
1	0.949	0.950
0.6	0.911	0.917
0.4	0.867	0.876
0.2	0.738	0.752
0.1	0.508	0.504

10. We must now inquire whether the necessary conditions (A) and (B) for the applicability of (15) are in fact fulfilled, for if they are not, any agreement between the figures in the second and third columns of Table VIII. can only be accidental. The results of the inquiry are summarized in Table IX. The conditions are least likely to be fulfilled in the case of each of the Tables I.-VI. for the greatest value of p within the range and the smallest value of V. The magnitude of the quantities which have to be small compared with 1 can be calculated by means of the figures given already and the known values of α and D. (These last values have been taken from Kaye & Laby's Tables.) The results of the calculation applied to the extreme cases of each of the Tables are tabulated in columns A and B, corresponding to conditions (A) and (B). In order to show once more how completely the measurements fail to conform to the older theory of conduction, the calculated values of V_p for the greatest pressure within the range is given in column C. An "observed" value for V_p cannot easily be given, for the figures in Table VIII. do not fit at all well with the theory whatever value of V_p is selected; but in order to make any point fit the theoretical curve, V_p would have to be taken > 0.1 volt.

Since the range of pressures over which the values given in Table VIII. are obtained extends further in the direction

of high pressures when X rays are used than when α rays are used, it would seem likely that the limit to the range on the side of high pressure is set by the increasing effects of recombination and the failure of condition (A). Table IX.

TABLE IX.

	A.	B.	C.
Table I.	0.001	0.004	0.0028
„ II.	0.015	0.126	0.0102
„ III.	0.001	0.003	0.0024
„ IV.	0.023	0.036	0.0045
„ V.	0.001	0.003	0.0034
„ VI.	0.000	0.006	0.0071

appears rather to show that it is condition (B) which fails, but in calculating the figures of Table IX. it is assumed that the ionization is uniform. This assumption is doubtless not true, especially when α rays are used, and a lack of uniformity in the ionization would certainly make condition (A) fail for lower pressures. Nevertheless it is surprising to find a number as large as 0.126 in column B; but remembering that the numbers in each column are extreme numbers, I do not think that they need throw any doubt on the view that the form of conduction studied in these experiments is indeed that to which the theory of § 2 applies, and that the limit to the range of its applicability on the side of high pressure is set by the effects of recombination.

The limitation of the range on the side of low pressure cannot be accounted for on the theory given. It is probably connected with the emission of δ rays with finite velocities from the plates of the condenser and from the gas. When the mean free path of the electrons becomes comparable with the distance between the plates, their initial velocities increase the proportion which travel across the condenser against the field; the coefficient of diffusion of the ions appears to be increased. And it might be expected that this effect would show itself first for the higher values of V corresponding to electronic velocities comparable with those of the δ rays, for so long as V is small compared with these velocities it can have no effect in producing a current carried by δ rays. Further consideration will be given in a later

paper to the influence of the finite velocity of the δ rays on conduction at very low pressures.

11. One remarkable observation must now be mentioned. It has been stated that similar results were obtained whether X rays or α rays were used ; different results were obtained when the β and γ rays from Ra were used. The experiments were more difficult because of the smallness of the currents which could be obtained, but it was found again that, within a certain range of pressure for each gas, the values of i/I were independent of the pressure and the same for all gases. But these values were certainly smaller than those obtained with α or X rays. The relation between i/I and V agreed best with that predicted by (15) if λ were taken to be 0.034 instead of 0.025, but the agreement between the observed and predicted values was not nearly so good as that shown in Table VIII. The numbers corresponding to those in Table IX. were all very much smaller than those in that table. The values of i/I were unaltered if the total current was diminished by moving the Ra further from the chamber, but they were decreased still further if it was diminished by interposing absorbing screens. The general results may be summarized by saying that, when these very penetrating rays were used, λ appeared to increase with the hardness of the rays.

These observations were made when the electrodes were covered with aluminium. The measurements were repeated when the electrodes were covered with soot, and it was then found that the anomaly had disappeared ; the measurements with β rays gave exactly the same results as those with α rays or X rays. The maximum values of i/I were the same whatever kind of ionizing rays was used, there being only a difference in the range of pressure over which these maximum values obtain. A comparison of these ranges is not possible, for the extent of the range depends on the intensity of the ionization, and the source of β rays used was so feeble that the limit of the range on the side of high pressure could not be observed.

The influence of the surface of the electrodes is remarkable and perhaps deserves further investigation. It appears that the influence is different according to the hardness of the rays used ; this fact indicates that an explanation of it cannot be found in a mere failure of the electrodes to absorb all the ions falling on them. Again, the effect can hardly be due to differences of the surfaces in the power of emitting δ rays, for in all these experiments the δ -ray current was quite inappreciable compared with the current due to the

gas. But the existence of the effect does not seem to invalidate the main conclusion of this paper, that the form of conduction observed is one in which the diffusion of the ions is overwhelmingly important as compared with their recombination. This conclusion does not affect in any way our theory of conduction; the prediction of such a form is implicit in the accepted theory, but it does not seem to have been noted that the necessary conditions are capable of experimental realization.

Summary.

§ 1, 2. A theory of conduction in an ionized gas is sketched applicable to experimental conditions, such that the effects of the recombination of the ions are inappreciable compared with those of their diffusion. It appears that if such conditions could be realized the form of the "saturation curve" of the ionized gas should depend on nothing but the temperature of the gas.

§ 3-8. The results are given of some recent measurements of the "saturation curves" of air, hydrogen, and carbon dioxide at pressures less than atmospheric contained between plates less than 3 mm. apart, and ionized by α or X rays. It appears incidentally that metal electrodes do not always absorb all the ions falling on them.

§ 9, 10. It is shown that the form of these saturation curves is inexplicable on the theory of conduction which applies to cases where recombination is the important process. On the other hand, this form is almost exactly that given by the theory sketched in § 2; it is found, as it is predicted, that the form of the saturation curve is, within certain limits, independent of the nature and pressure of the gas, of the distance between the electrodes, and of the intensity of the ionization. These limits are probably set, on the one hand, by the influence of recombination, on the other, by the finite initial velocities of the δ rays emitted in ionization.

§ 11. Certain anomalies were found when hard β and γ rays were used for ionization instead of α and X rays. These anomalies are not explained; they are connected with actions taking place at the surface of the electrodes, but their presence does not seem to affect the conclusions attained in the rest of the paper.

LXXX. *On the Forces acting on a Solid Sphere in contact with a Liquid Surface.* By ALLAN FERGUSON, B.Sc.(Lond.), Assistant-Lecturer in Physics in the University College of North Wales, Bangor*.

THE study of the problem from which this paper takes its title originated in an attempt made by the writer to apply the methods of approximation described in previous papers † to the problem of the force required to detach a circular disk from the surface of a liquid. Approximate solutions to this latter analytical problem have been given by Laplace ‡ and Poisson §, whilst, as an experimental method for the evaluation of surface tensions, it has been much favoured by earlier experimenters ||.

As considerable historic interest attaches to the problem, a brief *résumé* of the results obtained by the above methods of approximation will first be given, more especially as they differ in some respects from those obtained by other analysts, and as some of the formulæ developed will be used in the problem of the sphere.

Fig. 1.

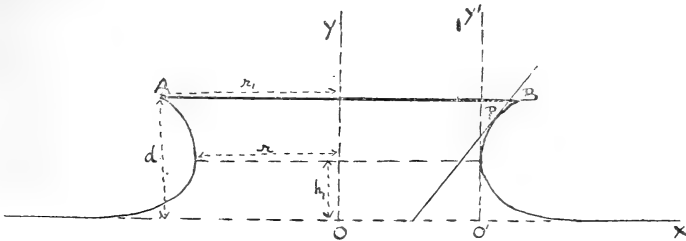

Let AB be the trace of the circular disk, raised to a height d above the general level of the liquid surface. The elementary theory ¶, which assumes the curvature of the liquid surface perpendicular to the plane of the paper

* Communicated by Prof. E. Taylor Jones.

† Phil. Mag. Dec. 1912, and April 1913. (The former paper will be cited hereinafter as *l. c.*)

‡ Méc. Céleste, tome x. Supp. pp. 48 *seqq.*

§ 'Nouvelle Théorie de l'action capillaire,' pp. 226 *seqq.*

|| Gay-Lussac (quoted by Laplace, *op. cit.* p. 54); Buys-Ballot, Pogg. *Ann.* p. 191 (1847); Merian, Pogg. *Ann.* p. 485 (1848); Hagen, Pogg. *Ann.* p. 464 (1849), &c.

¶ See, *e. g.*, Poynting & Thomson, 'Properties of Matter,' p. 161.

negligible compared with the curvature in the plane of the paper, gives

$$d^2 = 4a^2, \dots \dots \dots (i.)$$

and hence, if P be the pull required to detach the plate, and A its area,

$$P = Agpd = 2Agpa \dots \dots \dots (ii.)$$

where, as usual, $a^2 \equiv \frac{T}{gp}$.

More exactly, if we consider a point P on the upper part of the meniscus, we have for the differential equation to the surface at P,

$$\frac{1}{R_1} + \frac{1}{R_2} = \frac{y}{a^2} \dots \dots \dots (iii.)$$

Substituting for R_1 and R_2 their values, transferring the origin to O' , and dividing throughout by r , we obtain, as previously explained *,

$$-\frac{a^2 x}{r} \frac{dp}{dx} + a^2 \frac{dp}{dx} + \frac{a^2 p}{r} (1+p^2) = \frac{xy}{r} (1+p^2)^{\frac{3}{2}} - y(1+p^2)^{\frac{3}{2}}, \dots (iv.)$$

remembering that, at points such as P, $\frac{dp}{dx}$ is negative.

When r is infinite, this becomes

$$a^2 p \frac{dp}{dy} = -y(1+p^2)^{\frac{3}{2}}, \dots \dots \dots (v.)$$

giving on integration,

$$y^2 = h_1^2 + \frac{2a^2}{\sqrt{1+p^2}} \dots \dots \dots (vi.)$$

From $y=h$, downwards, the problem is exactly that of a liquid of zero contact-angle in external contact with a cylinder of radius r . Hence †

$$h_1^2 = 2a^2 - \frac{4a^3}{3r} \cdot \frac{2\sqrt{2}-1}{\sqrt{2}} \dots \dots (vi. a)$$

and

$$h_1^2 (r=\infty) = 2a^2.$$

* *L. c.* p. 839.
 † *L. c.* p. 841. Put $i=0$, and $h^2=2a^2$ in the small terms of equation (xi).

This gives at once from (vi.)

$$\frac{p}{\sqrt{(1+p^2)}} = \pm \frac{y\sqrt{(4a^2-y^2)}}{4a^2}, \dots \dots \dots \text{(vii.)}$$

and the positive sign must be chosen as $y^2 > 2a^2$.

Hence, substituting the values from (v.) in the small terms of (iv.), and the values from (vii.) in the small terms of the resulting equation, we obtain on integration

$$\frac{a^2}{\sqrt{(1+p^2)}} = \frac{y^2}{2} - \frac{1}{6r}(4a^2-y^2)^{\frac{3}{2}} - \frac{h_1^2}{2} + \frac{1}{6r}(4a^2-h_1^2)^{\frac{3}{2}}, \text{(viii.)}$$

which, substituting the above values for h_1^2 , and assuming that $p=0$ when $y=d$, gives

$$d^2 = 4a^2 + \frac{1}{3r}(4a^2-d^2)^{\frac{3}{2}} - \frac{4a^3}{3r} \cdot \frac{2\sqrt{2}-1}{\sqrt{2}} - \frac{1}{3r} \cdot \frac{4\sqrt{2}a^3}{2}. \text{(ix.)}$$

And, putting $d^2 = 4a^2$ in the small terms of (ix.), we have finally

$$d^2 = 4a^2 - \frac{8a^3}{3r}, \dots \dots \dots \text{(ix. a)}$$

which value, substituted in equation (ii.), gives

$$P = 2Ag\rho\left(a - \frac{a^2}{3r}\right), \dots \dots \dots \text{(x.)}$$

a more exact equation from which to calculate a^2 .

It is to be noted (fig. 1) that r is *not* the radius of the disk. The terms in r being assumed small, we may, as a first approximation put $r=r_1$. More closely, if we assume the meniscus to be circular in outline *, we have

$$r_1 = r + h = r + a\sqrt{2},$$

which, substituted in (x.), gives finally

$$P = 2Ag\rho\left(a - \frac{a^2}{3r_1} - \frac{a^3\sqrt{2}}{3r_1^2}\right). \dots \dots \dots \text{(xi.)}$$

This result is in agreement with that of Laplace if the term in r_1^2 be suppressed. Whether such a suppression is

* This, of course, is only very approximately true. It would be easy to find a more accurate—and more complex—correction. But the above assumption is close enough for the estimation of a second order term.

legitimate or not depends of course on the relative values of r_1 and a . In discussing some experiments made by Gay-Lussac with a disk 5.92 cm. in radius, Laplace obtains from his formula $P = 59.59$ grams weight, assuming for a^2 the value .0756 sq. cm. Gay-Lussac's experiment gives $P = 59.40$ grams weight—"ce qui s'accorde aussi bien qu'on peut le désirer, avec le résultat de l'analyse" *.

But if we take into account the third term of equation (xi.), the calculated value of P becomes 59.52 grams weight, in still closer agreement with the experimental result. The effect of this term is, therefore, with such a disk, small but appreciable; with a disk above 7 or 8 cm. in radius the effect of this third term is negligible.

But the doubtfulness of the assumption italicised above † considerably minimises the practical value of the method. Even if the contact-angle of the liquid be known, it is by no means certain that this is the angle at which the liquid meets the disk *along an edge*.

This objection is nullified if we substitute for the disk a segment of a sphere partly immersed in the liquid, so that the liquid touches the sphere round a small circle. In spite of its obvious advantages over the disk, this problem does not seem to have received any attention from either analysts or experimenters.

Fig. 2.

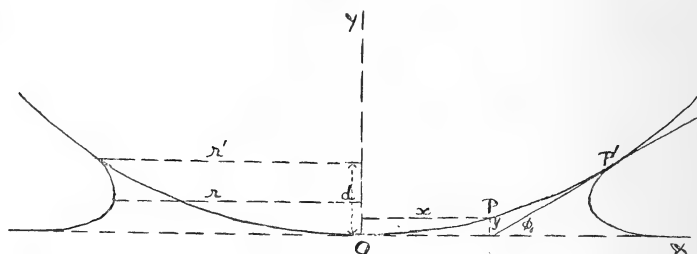

Various particular cases will be discussed later; for the present we confine ourselves to the case (fig. 2) in which the vertex of the sphere is just on a level with the general surface of the liquid.

We further assume that the radius (R) of the sphere is

* Laplace, *op. cit.* p. 54. (It is to be noted that throughout, in comparing theory with experiment, Laplace ignores the effect of temperature variations, excepting in so far as they affect the density of the liquid.)

† On this point *cf.* Mathieu, 'Théorie de la Capillarité,' p. 127.

large compared with a , and that the angle of contact of the liquid with the material of the sphere is zero. The extension of the formulæ to liquids of finite contact-angles presents no difficulty.

Considering the vertical components of the forces acting on the sphere, we have (1), a downward pull equal to

$$2\pi r'T \sin \phi_1;$$

(2), and (3), the vertical components of the hydrostatic forces on the concave and convex sides respectively of the sphere.

Let the atmospheric pressure be Π , and let Π_1 be the pressure at any point (x, y) in the liquid and on the surface of the sphere.

Then the vertical component of the force due to (2) and (3) on the element of surface swept out by the revolution of an element ds of the circle at (x, y) will be

$$\begin{aligned} &= 2\pi x ds \cos \phi (\Pi - \Pi_1) \\ &= 2\pi x dx (\Pi - \Pi_1) \\ &= 2\pi g \rho x y dx \\ &= 2\pi g \rho x (R - \sqrt{R^2 - x^2}) dx, \end{aligned}$$

since

$$\Pi_1 = \Pi - g\rho y$$

and

$$y = R - \sqrt{R^2 - x^2}.$$

The total hydrostatic pull is therefore

$$\begin{aligned} &= 2\pi g \rho \int_0^{r'} x (R - \sqrt{R^2 - x^2}) dx \\ &= 2\pi g \rho \left[R \frac{r'^2}{2} + \frac{(R^2 - r'^2)^{\frac{3}{2}}}{3} - \frac{R^3}{3} \right]. \end{aligned}$$

And therefore, if we suppose that these surface-forces are balanced by an upward pull of mg dynes, the equation of equilibrium of the sphere will be

$$mg = 2\pi r'T \sin \phi_1 + 2\pi g \rho \left[\frac{Rr'^2}{2} + \frac{(R^2 - r'^2)^{\frac{3}{2}}}{3} - \frac{R^3}{3} \right]. \quad (\text{xii.})$$

Remembering that

$$\sin \phi = \frac{r'}{R}, \quad \text{and therefore} \quad \sin \phi_1 = \frac{r'}{R},$$

and putting

$$a^2 \equiv \frac{T}{g\rho},$$

(xii.) becomes

$$m = 2\pi a^2 \rho \frac{r'^2}{R} + 2\pi \rho \left[\frac{Rr'^2}{2} + \frac{(R^2 - r'^2)^{\frac{3}{2}}}{3} - \frac{R^3}{3} \right]. \quad \text{(xiii.)}$$

Let d be the value of y at the point ϕ_1 ; then

$$r'^2 = d(2R - d),$$

and (xiii.) becomes, after a few reductions,

$$m = 2\pi \rho \left\{ \frac{Rd^2}{2} + 2a^2d - \frac{d^3}{3} - \frac{a^2d^2}{R} \right\}. \quad \text{(xiv.)}$$

Returning now to equation (vii.), if we remember that in the present problem $p = \tan \phi_1$ when $y = d$, we have, substituting these values in equation (vii.),

$$d^2 = 2a^2(1 + \cos \phi_1) + \frac{1}{3r} (4a^2 - d^2)^{\frac{3}{2}} - \frac{4a^3}{3r} \cdot \frac{2\sqrt{2} - 1}{\sqrt{2}} - \frac{2\sqrt{2}a^3}{3r}. \quad \text{(xv.)}$$

Putting $d^2 = 2a^2(1 + \cos \phi_1)$ in the small terms of (xv.), and remembering that $\cos \phi_1 = \frac{R-d}{R}$, we obtain

$$d^2 = 2a^2 \left(2 - \frac{d}{R} \right) + \frac{2\sqrt{2}a^3}{3r} \left(\frac{d}{R} \right)^{\frac{3}{2}} - \frac{4a^3}{3r} \cdot \frac{2\sqrt{2} - 1}{\sqrt{2}} - \frac{2\sqrt{2}a^3}{3r}, \quad \text{(xv.a)}$$

$$= 4a^2 \left(1 - \frac{a}{R} \right) + \frac{8a^3}{3r} \left(\frac{a^{\frac{3}{2}}}{R^{\frac{3}{2}}} - 1 \right), \quad \text{(xvi.)}$$

remembering that, since R is large compared with d , we may put the approximate value $d^2 = 4a^2$ in the second and third terms of (xv.a).

(Note that if we put $R = \infty$ in equation (xvi.), we recover, as we should do, equation (ix.a) of the flat-disk problem.)

To a first approximation we may put $r = r'$ (fig. 2); if desired, a closer approximation may be found by following the reasoning which results in equation (xi.). Putting, therefore,

$$r^2 = r'^2 = d(2R - d) = 2Rd,$$

we have, substituting for r in (xvi.) and reducing,

$$d^2 = 4a^2 \left\{ 1 - \frac{a}{R} - \frac{\sqrt{a}}{3\sqrt{R}} \right\} \dots \dots \dots \text{(xvii.)}$$

In equation (xiv.) the first term is by far the largest; in the remaining small terms the approximate value $d=2a$ may be substituted. Making these substitutions, we easily obtain

$$m = 2\pi\rho \left\{ 2a^2R - \frac{2}{3}a^2\sqrt{aR} - \frac{4a^4}{R} \right\}.$$

The last term is usually negligible, giving

$$m = 4\pi\rho a^2 \left\{ R - \frac{\sqrt{aR}}{3} - \frac{a}{3} \right\}, \dots \dots \text{(xviii.)}$$

a simple equation from which to calculate a^2 when m and R are known. It is best solved by successive approximations.

In order to apply equation (xviii.) to determine surface tensions, a large hollow sphere of glass was taken and its external radius measured by means of a spherometer. No appreciable variation in the radius could be detected over the portion which was subsequently in contact with the liquid under examination. The sphere, after having been cleansed by alternate washings with caustic soda solution and distilled water, was dried and fastened by a thread about 20 cm. in length to the underside of the pan of a balance standing on a high shelf, the thread passing through holes in the base-board of the balance and the shelf. On a lower shelf, underneath the sphere, stood a small table whose height could be adjusted by means of a screw, which table carried a carefully cleaned porcelain basin containing the liquid under examination.

The sphere having been first counterpoised, the balance was left perfectly free and the height of the table adjusted until the liquid just touched the vertex of the sphere. This point was sharply defined by the sudden swing of the balance-pointer as the sphere touched the liquid and was pulled down. (In order to obtain consistent results, great care must be taken that the balance is quite at rest and the pointer exactly over the zero at the instant when the sphere and liquid make contact.) Weights were then added till the pointer was brought back to the zero, the mass of these weights being the m of equation (xviii.).

As, under ordinary circumstances, the values of m range from 2 to 6 grams, a super-sensitive balance is not a desideratum; it is extremely difficult to keep such a balance at rest for any length of time, whilst the precaution just described is absolutely essential to the consistency of the results. Remembering then that, as equation (xviii.) shows, the value of m is approximately proportional to T , it will be seen that a balance which just turns with 2 or 3 milligrams will give the value of T to at least 1 part in 1000, as far as the weighings are concerned.

Three liquids were selected for examination—benzene, absolute alcohol, and water. The experiments of Magie* have shown that these three liquids, in contact with glass, have zero contact-angles. In the case of the last-mentioned liquid, tap-water was used, as the laboratory supply is remarkably free from dissolved substances, and experience has shown that tap-water is, on the whole, more likely to be free from surface impurities than a sample of distilled water which has been stored in a bottle.

We now proceed to discuss the numerical values obtained. The figures given below are in all cases in c.g.s. units, whilst temperatures are given in degrees centigrade. For the sake of comparison the surface tensions are in all cases reduced to 15° , from the known values of the temperature coefficients.

Benzene (chemically pure).

Radius of sphere = 7.321 cm.

θ .	m .	a^2 .	T_θ .	T_{15} .	δ .
16°	2.565	.03383	29.14	29.29	+0.05
14.2	2.585	.03410	29.37	29.25	+0.01
15.3	2.573	.03393	29.22	29.26	+0.02
14.2	2.582	.03405	29.33	29.21	-0.03
14.3	2.580	.03402	29.31	29.21	-0.03
14.2	2.585	.03410	29.37	29.25	+0.01
14.5	2.582	.03405	29.33	29.26	+0.02
14.2	2.583	.03406	29.34	29.22	-0.02

Mean value, $T_{15} = 29.24 \frac{\text{dynes}}{\text{cm.}}$

Greatest divergence from mean value = .17 per cent.

* Phil. Mag. vol. xxvi. p. 162 (1888).

Absolute Alcohol.

($\rho_{15} = \cdot 795$. For chemically pure ethyl alcohol, $\rho_{15} = \cdot 794$.)

Radius of sphere = 7.321 cm.

θ .	m .	a^2 .	T_{θ} .	T_{15} .	δ .
15.6	2.030	.02949	23.00	23.06	-.05
13.8	2.050	.02979	23.24	23.13	+.02
14.5	2.040	.02963	23.12	23.07	-.04
13.8	2.048	.02975	23.20	23.09	-.02
14.9	2.045	.02971	23.17	23.16	+.05
14.6	2.050	.02979	23.24	23.20	+.09
13.8	2.050	.02979	23.24	23.13	+.02
15.3	2.035	.02956	23.06	23.09	-.02
14.2	2.045	.02971	23.17	23.10	-.01

Mean value, $T_{15} = 23.11 \frac{\text{dynes}}{\text{cm.}}$

Greatest divergence from mean = .38 per cent.

Water.

As the water used was generally, at the beginning of an experiment, slightly below the temperature of the room, it was easily possible to make a series of weighings as the temperature slowly rose. In the following Table, weighings made on the same sample are indicated by the same letter.

Radius of sphere = 7.321 cm.

Series.	m .	θ .	T_{θ} .	T_{15} .	δ .
A.	6.365	15.3	73.53	73.58	+.13
A.	6.360	15.6	73.48	73.57	+.12
A.	6.355	15.8	73.41	73.53	+.08
A.	6.350	16.1	73.35	73.49	+.04
A.	6.345	16.7	73.28	73.53	+.08
B.	6.385	14.7	73.77	73.74	+.29
C.	6.365	15.2	73.53	73.57	+.12
D.	6.365	14.6	73.53	73.47	+.02
E.	6.360	14.2	73.48	73.36	-.09
E.	6.350	14.6	73.35	73.29	-.16
F.	6.350	14.8	73.35	73.32	-.13
G.	6.320	16.3	72.99	73.18	
G.	6.310	17.0	72.87	73.16	
G.	6.295	17.3	72.69	73.03	
H.	6.350	14.7	73.35	73.30	-.15
K.	6.350	14.6	73.35	73.29	-.16
L.	6.380	13.6	73.68	73.46	+.01
L.	6.375	13.8	73.63	73.45	±.00
L.	6.360	14.2	73.48	73.37	-.08
L.	6.345	15.4	73.28	73.35	-.10

The mean of the twenty experiments gives

$$T_{15} = 73.40 \text{ dynes per cm.},$$

with a probable error of $\pm .03$. But the series G is notably lower than the rest, and judging both from the consistency of the three readings G amongst themselves, and the consistency of the remaining 17 readings, which have been taken on 9 different specimens of water, it seems almost certain that the lowness of the readings G is due to the presence of traces of surface impurities. Rejecting the series G in taking the mean, we have

$$T_{15} = 73.45 \pm .023 \frac{\text{dynes}}{\text{cm.}}$$

For convenience of comparison, a table of values due to other experimenters is appended.

T_{15} .	Observer.	Method.
73.26	Volkman . . .	Capillary tubes.
73.46	Donike	Capillary tubes.
73.45	Hall	Weighing tension in film.
73.76	Sentis.....	Capillary tubes.
73.72	Dorsey	Ripples.
74.30	Pedersen	Waves on jet.
72.78	Bohr	Waves on jet.
74.22	Kalähne.....	Rippled surface used as diffraction grating.

The method, considered as a practical means for the determination of surface tensions, shares, with several others of the well-known methods, the disadvantage of requiring a knowledge of contact-angles. Apart from this qualification, however, it is extremely consistent in practice, and very sensitive. As the above table shows, a change of surface tension due to a rise of .2 or .3 degree in temperature can be readily and accurately estimated. In this respect the sensitiveness of the method is comparable with that of the "capillary multiplier," and considerably exceeds that of the classic capillary tube.

University College of North Wales,
Bangor.

July 1913.

LXXXI. *Notices respecting New Books.*

Vectorial Mechanics. By L. SILBERSTEIN, Ph.D., Lecturer in Natural Philosophy at the University of Rome. Pp. viii + 197. London: Macmillan & Co. Price 7s. 6d. net.

THE use of vector notation, though long delayed, is now gradually extending. The large amount of work done in connexion with the electromagnetic field—a region of investigation which brings out very clearly the utility of this notation—has contributed mainly to this advance. The particular form which has been most adopted is based on that put forward by Oliver Heaviside, and it is to Heaviside's excellent book ('*Electromagnetic Theory*,' 1893) that one has been accustomed to turn. The great simplification in theoretical investigations which the notation introduces is responsible for its growing employment; a somewhat lethargic unwillingness to trouble about an unfamiliar thing is responsible, at any rate in part, for its neglect. There is, however, the additional reason that results obtained with remarkable simplicity by this method require to be extended into the more familiar notation when the question of numerical calculation arises. The practical man has therefore been averse from having anything to do with it; but as the practical man is seldom concerned with the theoretical proof of principles, his objections can have little final weight.

The present volume has for its object the presentation of the chief principles and theories of theoretical mechanics in the language of vectors. By choosing this branch of science instead of the more recondite science of electromagnetism as a basis for exposition, it is reasonably hoped to encourage the diffusion of the use of vectorial methods. The main object is kept in view throughout. Discussions of the philosophical aspect of mechanical quantities are consequently excluded. But, starting from D'Alembert's principle, the book is a continuous treatise on mechanics in vectorial language. This is preceded in Chapter I. by an exposition of the notation and of the general properties of vectors and the operations to be performed on them. The mechanics includes the properties of the motion of rigid bodies, of the motions and strains of deformable solids, and hydromechanics. A series of problems (with hints toward solution) is arranged at the end in the order in which the questions referred to occur in the text. An appendix contains the Cartesian equivalents of vector formulæ.

This is no perfunctory exposition of the subject of vectors. Dr. Silberstein is an enthusiast for the subject. He decries the hopeless complication often introduced into problems by Cartesian methods—"a complication which does not arise from the intrinsic peculiarities of the phenomena in question, but is wholly artificial,

a complication not due to Nature but to the (mathematizing) naturalist. Now, Nature is of herself wonderfully complicated; so that supplementary complication is not wanted."

The book may be very strongly recommended. No other exposition of the subject approaches it in clearness and thoroughness. The time is past when a man could afford to be ignorant of vectorial methods. No one can be abreast of recent work in physics who has no acquaintance with them. The publishers are to be commended on the excellence of their contribution to the attractiveness of this volume.

Bulletin of the Bureau of Standards. Vol. VIII. Nos. 2, 3, 4; Vol. IX. No. 1. Washington: Government Printing Office.

THESE parts contain a large number of important and interesting papers. In No. 2, Mr. Buckingham discusses Guillaume's and Mahlke's method of correcting for the emergent stem of the mercurial thermometer. Messrs. Rosa, N. E. Dorsey, and J. M. Miller detail a determination of the International ampere in absolute measure. The final result expressed in terms of the electrochemical equivalent of silver is 1.11804 mgm. per coulomb, instead of 1.11800 as adopted by the London Conference. Mr. H. H. Brooks writes on deflexion potentiometers and the design of moving-coil galvanometers.

In No. 3, Mr. P. G. Nutting describes further experiments on the luminous properties of electrically conducting helium gas; and Mr. J. G. Priest gives the results of a redetermination of the wave-lengths of ten of the lines of the neon spectrum obtained by aid of reflexion fringes. Mr. Buckingham discusses the deduction of Wien's displacement law.

In No. 4, Mr. P. G. Agnew describes a tubular electro-dynamo-meter for heavy currents, and Mr. D. R. Harper gives a very full treatment of the question of the lag of various mercurial and electrical thermometers.

Vol. IX. No. 1 begins with a very interesting account of a new precision colorimeter designed by Mr. P. G. Nutting. This depends on (so-called) *monochromatic* analysis, the match being obtained by adding to or subtracting from white light a certain monochromatic tint. Mr. W. W. Coblentz continues a discussion of instruments and methods used in radiometry and, in a second article, the selective radiation from various substances.

Mr. L. W. Austin takes up the question of antenna resistance and that of energy losses in some condensers used in high-frequency circuits. Amongst chemical articles we may mention one by Mr. H. C. P. Weber on the atomic weight of bromine. The final value given is $79.306_8 \pm .0014$.



JOLLY.

FIG. 2.

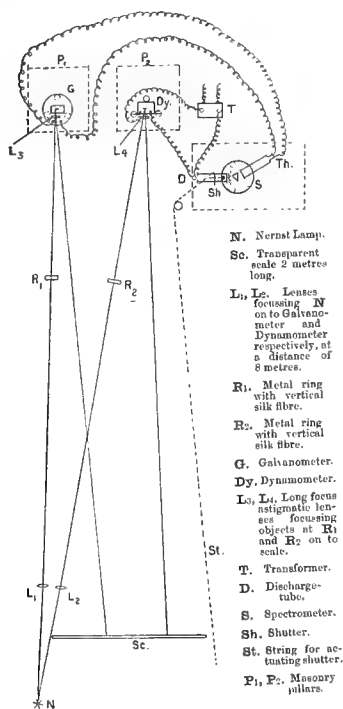

- N. Nernst Lamp.
- Sc. Transparent scale 2 metres long.
- L₁, L₂. Lenses focusing N on to Galvanometer and Dynamometer respectively, at a distance of 8 metres.
- R₁. Metal ring with vertical silk fibre.
- R₂. Metal ring with vertical silk fibre.
- G. Galvanometer.
- Dy. Dynamometer.
- L₃, L₄. Long focus stigmatic lenses focusing objects at R₁ and R₂ on to scale.
- T. Transformer.
- D. Discharge-tube.
- S. Spectrometer.
- Sh. Shutter.
- St. String for actuating shutter.
- P₁, P₂. Masonry pillars.

FIG. 3.

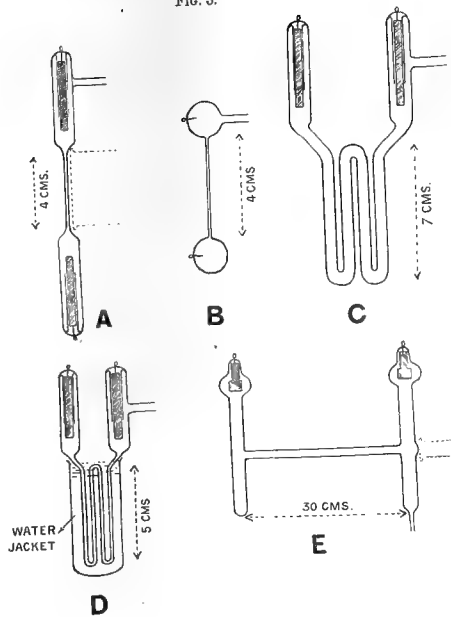

FIG. 5.

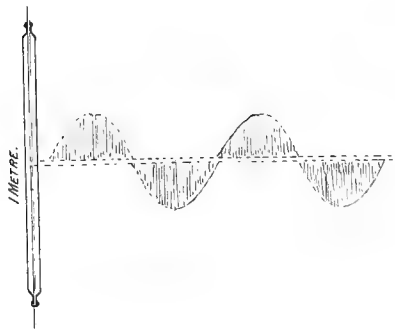

FIG. 6.

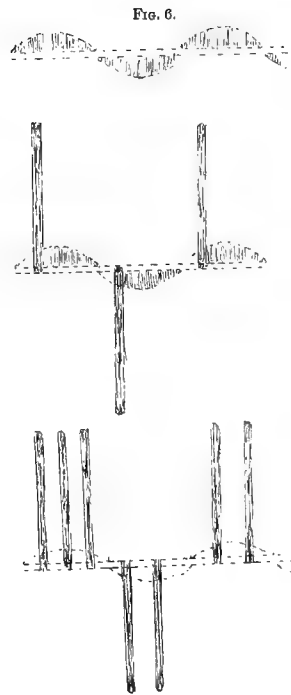

FIG. 7.

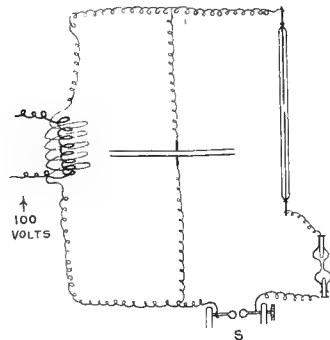
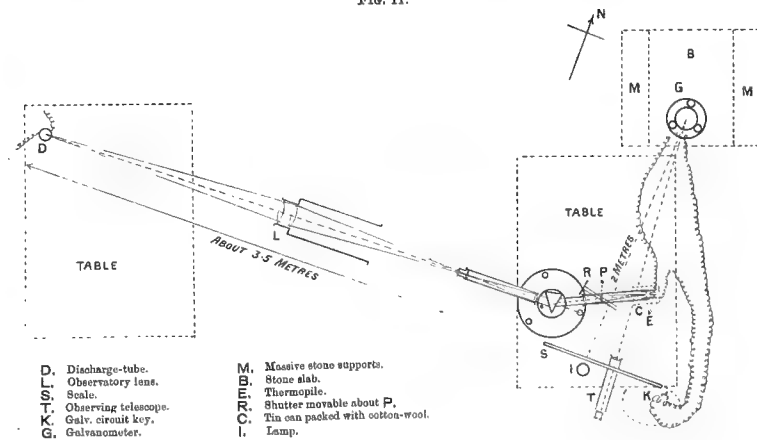

FIG. 11.



- D. Discharge-tube.
- L. Observatory lens.
- S. Scale.
- R. Observing telescope.
- K. Galv. circuit key.
- G. Galvanometer.

- M. Massive stone supports.
- B. Stone slab.
- E. Thermopile.
- R. Shutter movable about P.
- T. Tin can packed with cotton-wool.
- I. Lamp.

FIG. 8.

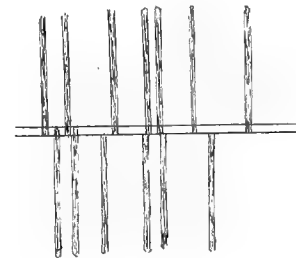

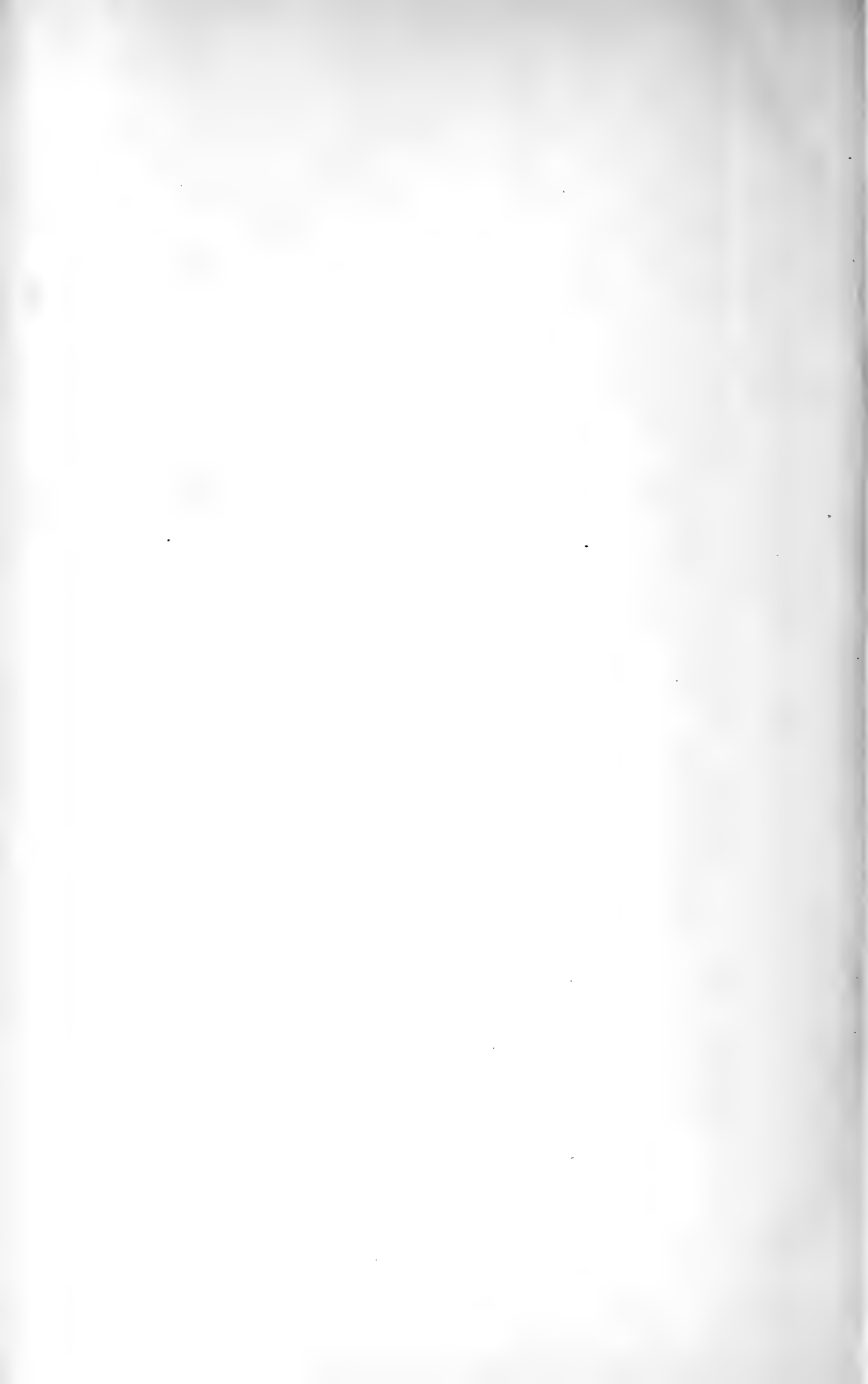

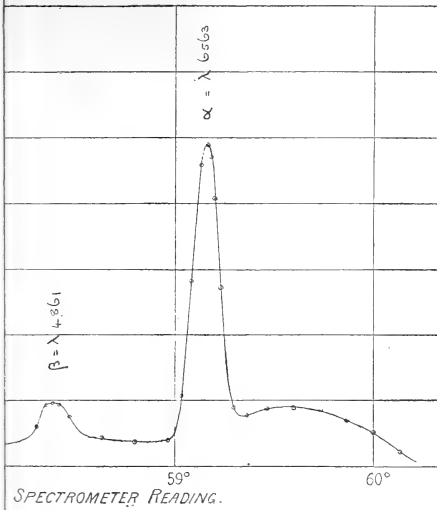

l visible — *The Hydrogen Spectrum.*

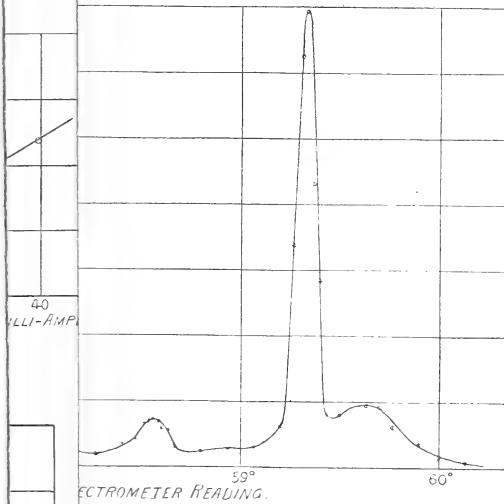

of Air (contaminated with Hydrogen).

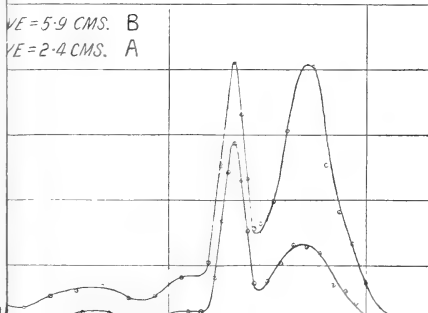



CURVE 1.

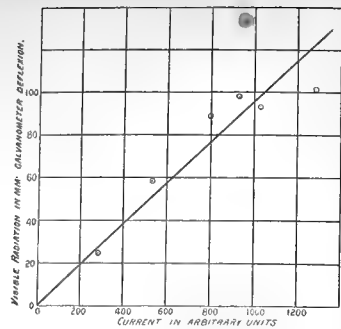

CURVE 2A.—Curve showing the relation between electroscopie deflexions and applied potential, as measured by the potentiometer method.

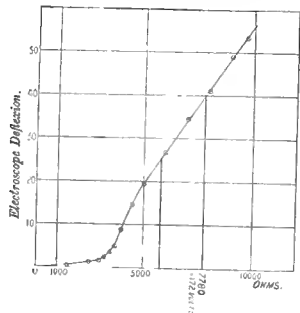

CURVE 2B.—Electroscopie deflexions in relation to Applied Potential, by potentiometer method.

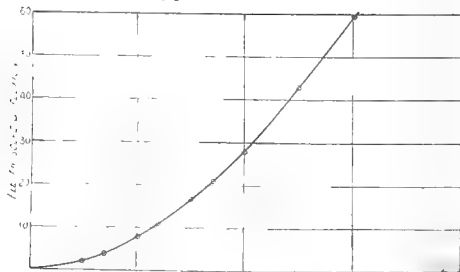

CURVE 3.—Curve showing relation between current and pressure in a capillary discharge-tube, when the source of E.M.F. is the same throughout.

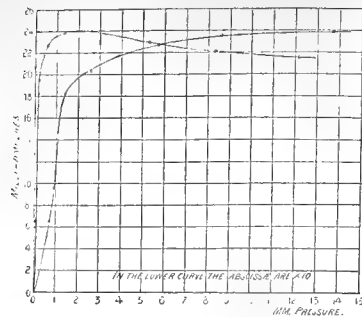

CURVES 4 & 5.—Two curves showing the relation between Total visible radiation and Current Density.

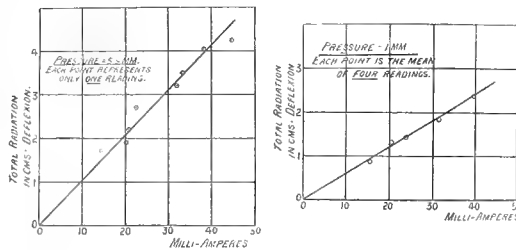

CURVE 6.

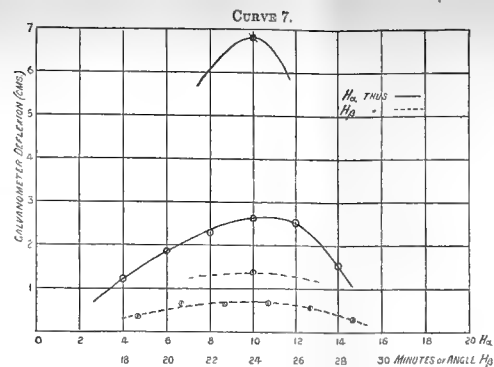
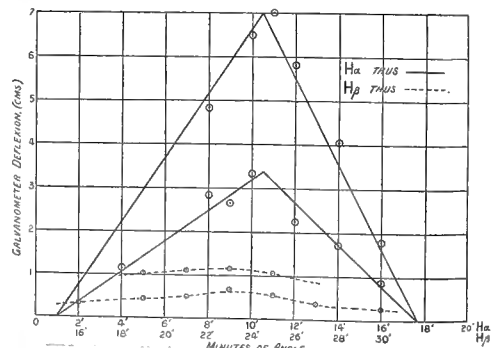

CURVE 8.—Relation between Pressure and Energy-Shift in the Spectrum of Hydrogen.

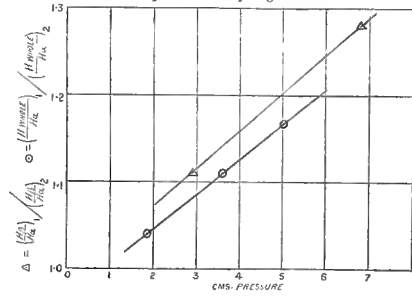

CURVE 9.—The Distribution of Energy in the Spectrum of Hydrogen.

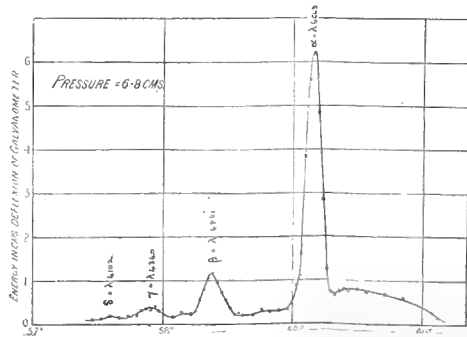

CURVE 10.—The Hydrogen Spectrum. (Water Vapour present.)

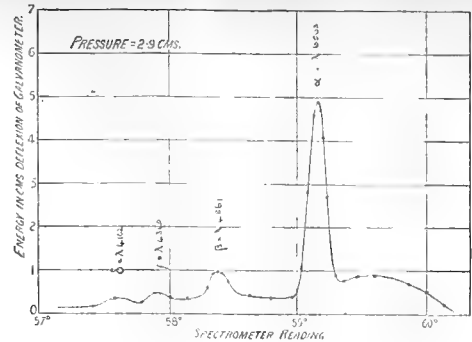

CURVE 11.—The Hydrogen Spectrum.

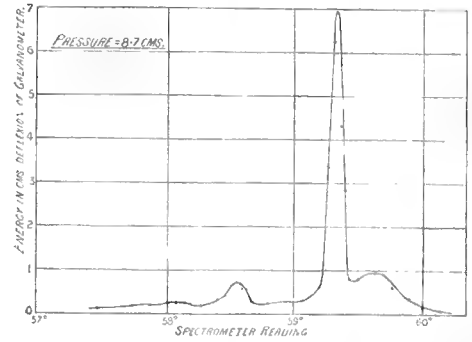

CURVE 12.—Spectrum of Air (contaminated with Hydrogen).

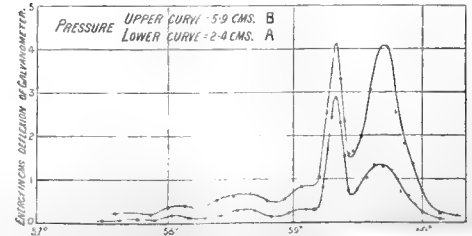



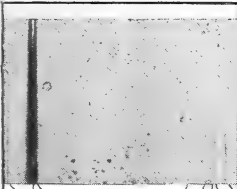

6010.8
6009.1
6000.3
5997.3
6086.6
6084.3
6082.3
6075.3

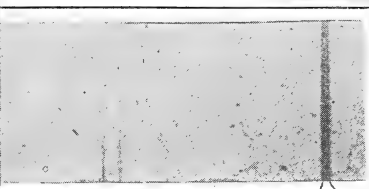
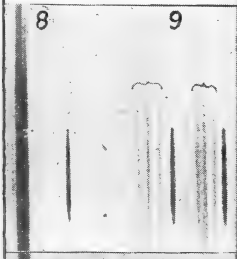

Fig. 1

6560.7
6558.4



8

9



Fig. 2

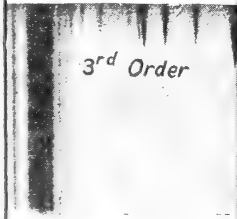
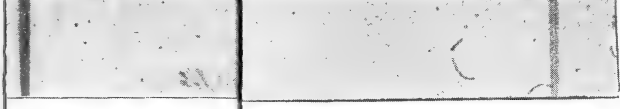

3rd Order

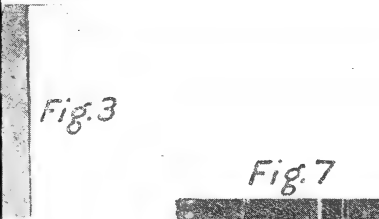
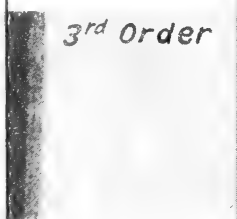

Fig. 3



3rd Order

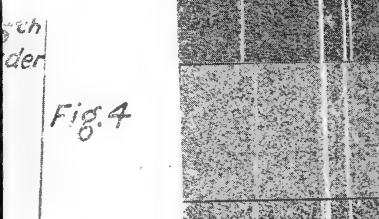
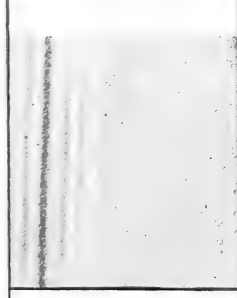

Fig. 4



Hg Hg

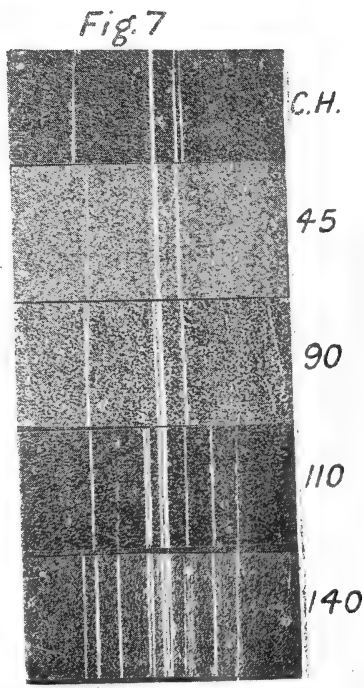

Fig. 7

C.H.

45

90

110

140





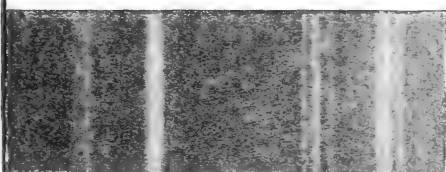
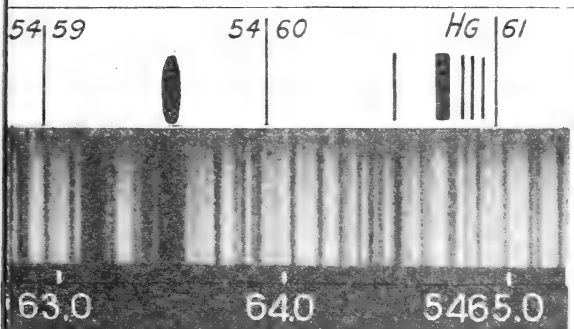

Fig. 2

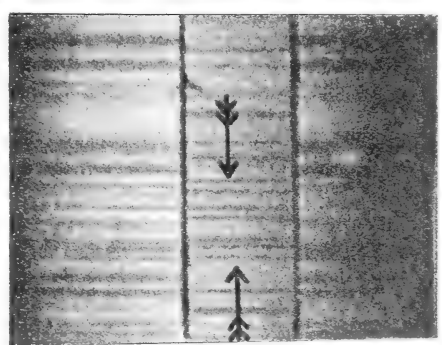

Fig. 3

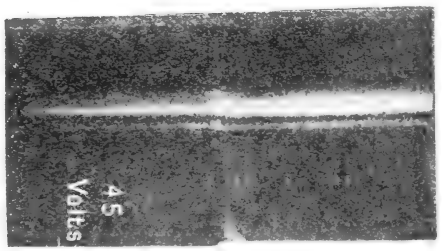
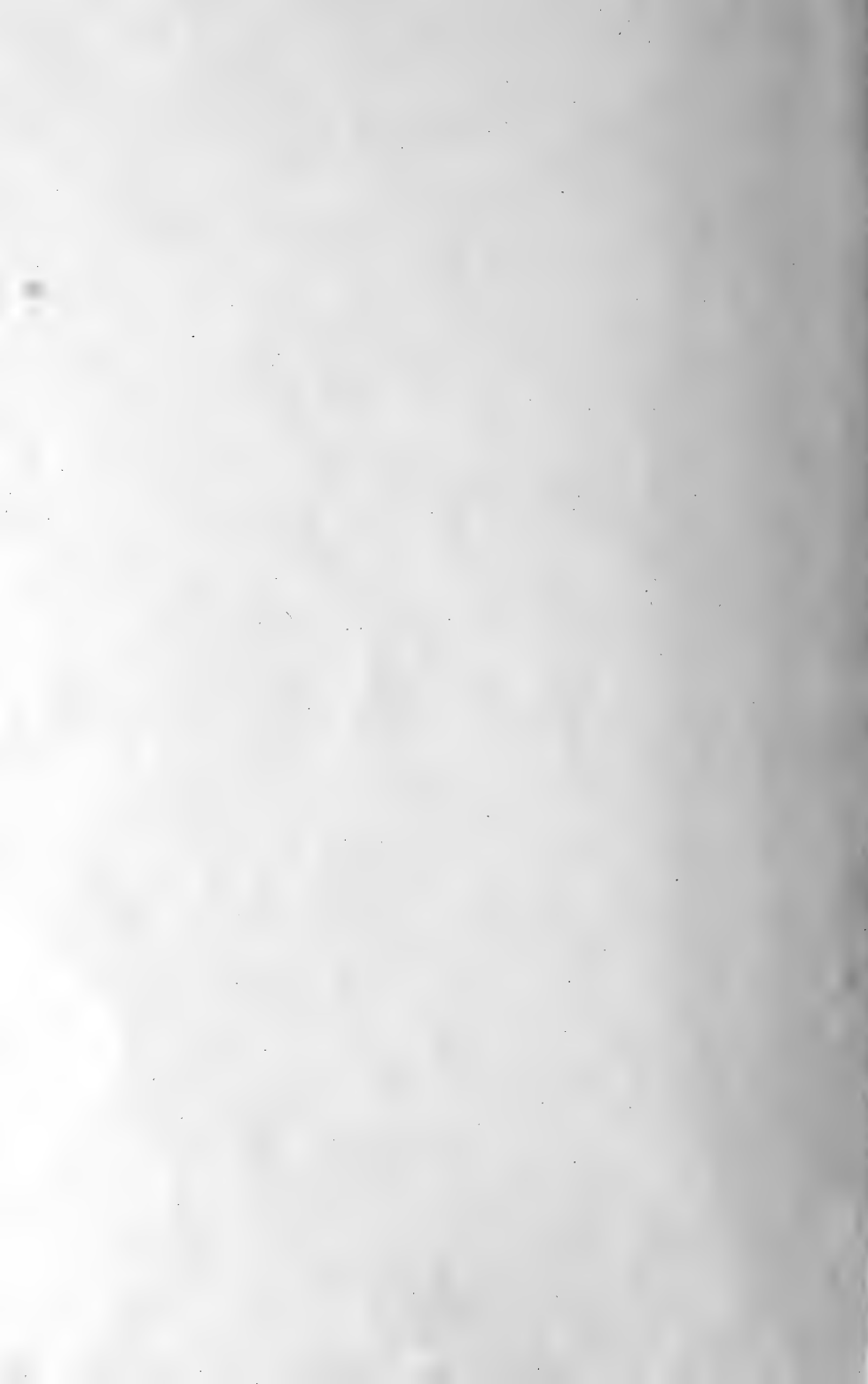
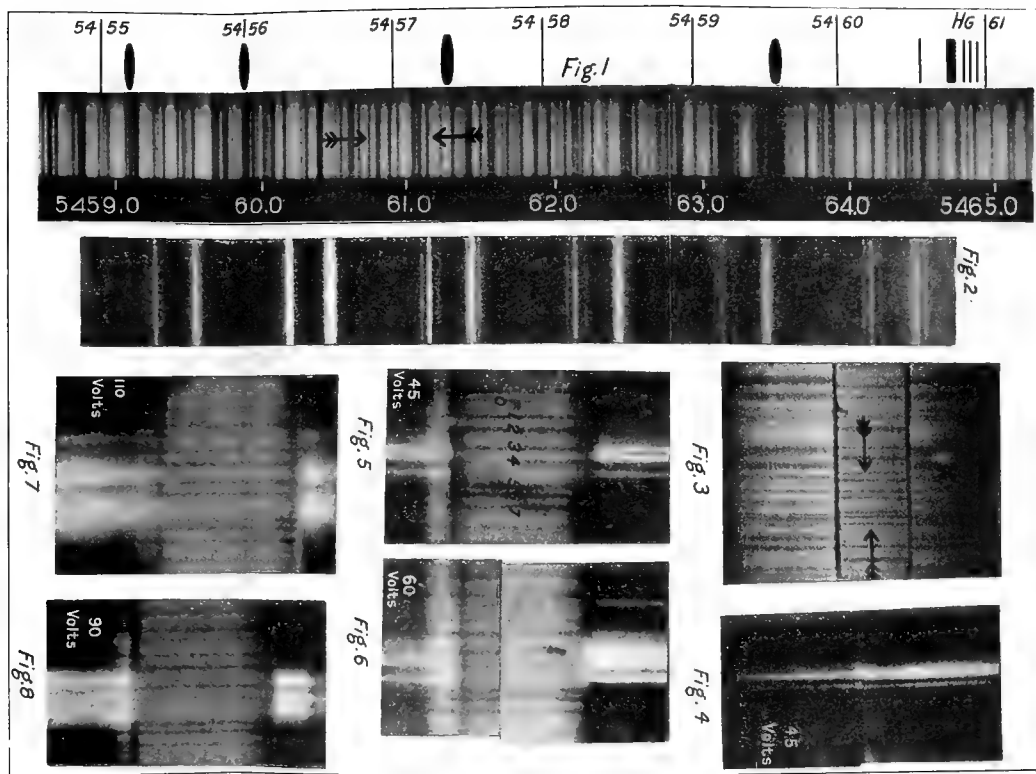

Fig. 4







5461 R.R. LINE.

5525

5658

5794

5864

6010

6164

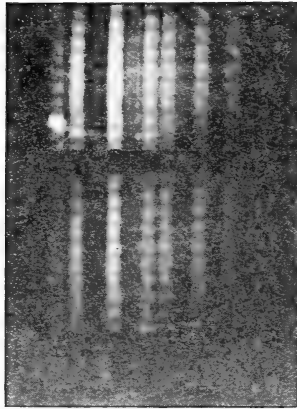



FIG. 5.

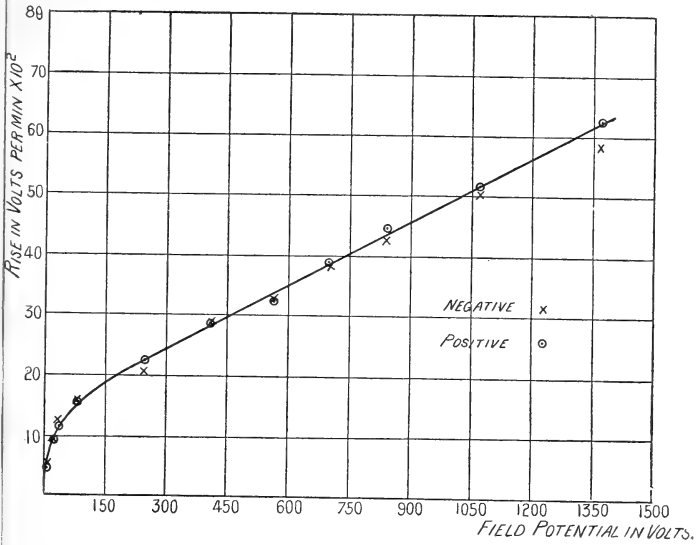

FIG. 9.

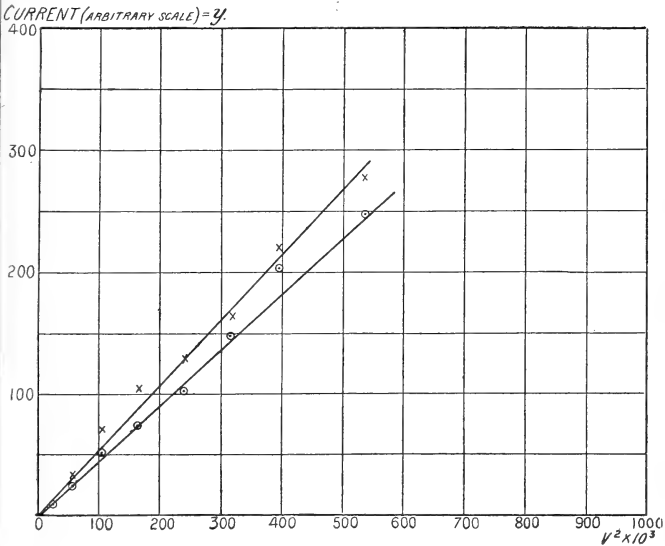



FIG. 2.

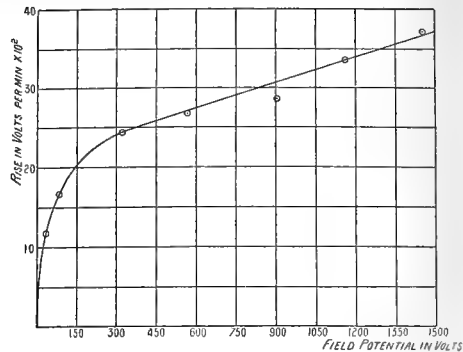

FIG. 4.

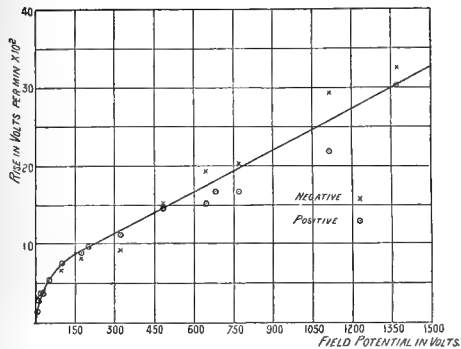

FIG. 5.

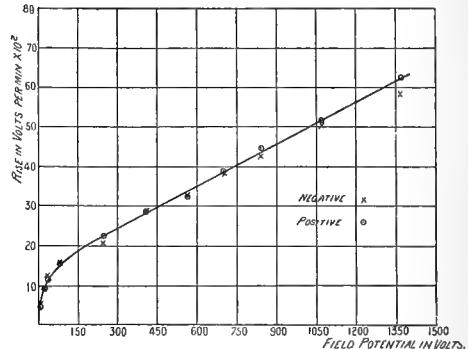

FIG. 6.

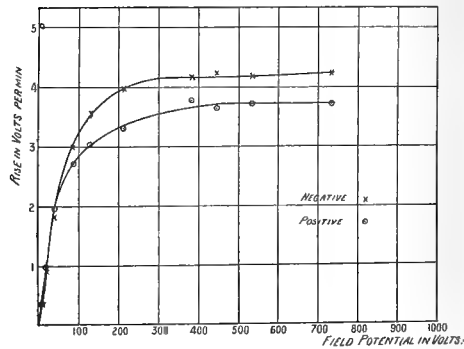

FIG. 8.

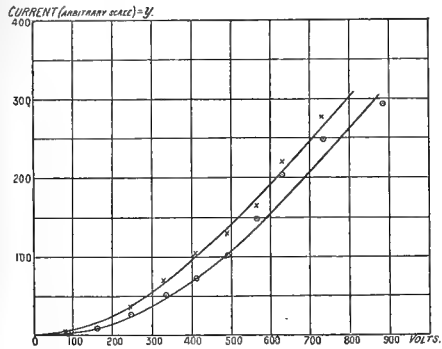
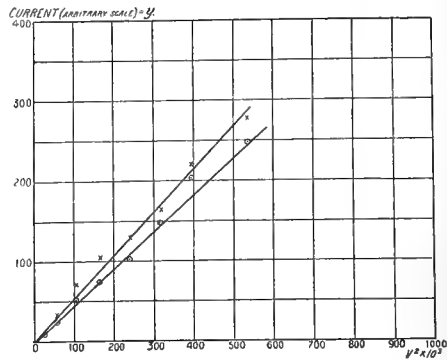

FIG. 9.





THE
LONDON, EDINBURGH AND DUBLIN
PHILOSOPHICAL MAGAZINE
AND
JOURNAL OF SCIENCE.

[SIXTH SERIES.]

DECEMBER 1913.

LXXXII. *Analysis of the γ Rays of the Thorium and Actinium Products.* By Prof. E. RUTHERFORD, F.R.S., and H. RICHARDSON, M.Sc., Beyer Fellow, University of Manchester*.

[Plate XIX.]

IN previous papers † we have analysed the γ radiations emitted by the radium products radium B, radium C, radium D, and radium E into a number of groups of different penetrating powers. An examination of the thorium products, viz., mesothorium 2, thorium B, thorium C, thorium D, and of the actinium products has been undertaken by a similar method, and results of the same general character as in the case of radium have been obtained. The γ rays of these substances have been found to consist of distinct groups of rays absorbed exponentially by aluminium and differing widely in their absorption by matter.

As the apparatus and methods employed were the same as those previously used in the investigation of the rays from radium D and radium E, and described in a former paper, it is not necessary to discuss them further here.

Preliminary investigations of the γ rays from the thorium products were made by using the active deposit of thorium, obtained by exposure of a negatively charged wire to the emanation from a preparation of mesothorium. The effect obtained was, however, too small for accurate measurement.

* Communicated by the Authors.

† Rutherford & Richardson, *Phil. Mag.* xxv. p. 722 (1913), and xxvi. p. 324 (1913).

To overcome this difficulty, the various active products were separated from a preparation of mesothorium, which had a γ -ray activity equal to about 2.5 milligrams of radium. Since mesothorium always contains some radium, which is inseparable from it, it was necessary to take precautions that none of the γ -ray products of the latter should interfere in the measurements.

The mesothorium was dissolved in a very small quantity of dilute HCl and the solution made up to 0.5 c.c. This solution was heated on a water-bath for six hours, in order to drive off any radium emanation formed in the interval. During that time any radium B or radium C present practically disappeared. A nickel wire .3 mm. in diameter was then rotated in the solution for about 30 minutes, in order to collect the thorium C upon it. The nickel wire was found to be sufficiently active to show a strong γ -ray activity in the electroscope, and the purity of the deposit of thorium C was confirmed by examining its rate of decay. The γ -ray effect due to the nickel wire in this case arose not from the thorium C, which is an α -ray product, but from the thorium D.

By suitable chemical operations the mesothorium was separated from the radiothorium. A few details of the chemical methods employed will be given, and we desire to express our thanks to Dr. Russell and Mr. Chadwick for kindly undertaking the work of chemical separation.

To the acid solution of mesothorium a few milligrams of aluminium chloride were added. Pure ammonia gas was then passed into this solution and aluminium hydroxide was precipitated. With this came down also the products mesothorium 2, radiothorium, thorium B, thorium C, thorium D, and any trace of radium B and radium C that might be present. This precipitate was filtered off and re-dissolved in a small quantity of dilute hydrochloric acid. 10 milligrams of lead chloride were then added, and H_2S was passed through the solution. The precipitate of lead sulphide was filtered off and carried with it the radium B, radium C, thorium B, thorium C, and thorium D. If any radium B or radium C were present, these would decay in the course of a few hours, and the source then consisted of thorium (B+C+D) in equilibrium. Since the radiation from thorium (C+D) was determined in the case of the deposit on the nickel wire, the γ radiation from thorium B could be deduced by a comparison of the absorption curves in the two cases.

The filtrate was evaporated to dryness and the H_2S

expelled. The residue was obtained on a watch-glass and consisted of a thin layer of solid matter. This residue contained all the radiothorium and mesothorium 2. Since radiothorium itself does not emit γ rays, the examination of this source immediately after its preparation gave the γ rays belonging to mesothorium 2. The latter decays to half value in 6.2 hours, and has practically disappeared in the course of two days. In the meantime the radiothorium had produced thorium X and its subsequent products, viz. thorium emanation and the active deposit, and this source was used to test again the γ radiation from thorium (B+C+D). We obtained no definite evidence that thorium X emits a quantity of γ rays which could be detected in our experiments*.

Analysis of the γ rays from Thorium (C+D).

The γ radiation was examined in the electroscope containing methyl iodide, using, as before, a strong magnetic field to remove the β rays. The source used in these experiments consisted of the deposit of thorium (C+D) on the nickel wire mentioned above. The absorption curve showed that two types of radiation were present. About 80 per cent. of the total radiation consisted of a very hard type, which was exponentially absorbed in aluminium and had an absorption coefficient in that substance of $\mu=0.096$ (cm.)⁻¹. The other radiation present was much less penetrating and was completely stopped by 2 mm. of aluminium. This soft radiation, however, was not absorbed exponentially by aluminium, and would thus appear to be complex in character. The general evidence indicates that this soft radiation is not emitted by thorium C or thorium D, but is excited in the nickel by the α or β rays. It will be remembered that a radiation of almost identical type was found when radium C was deposited on nickel†. It is intended to make a more detailed examination as to whether radiations of this kind are to be attributed to the excitation of one or more types of characteristic radiation by the

* L. Meitner and Hahn (*Phys. Zeit.* xiv. p. 873, 1913) have recently examined the products thorium X and thorium C for γ rays. Both of these products have been found to emit γ rays in small quantity. The presence of a small amount of γ radiation from these substances would, however, have no appreciable effect on the absorption curves obtained by the methods used in our experiments.

† Rutherford & Richardson, *Phil. Mag.* xxv. p. 730 (1913).

α or β rays in the material on which the active matter is deposited.

Since thorium C does not emit any appreciable γ radiation, the results of these experiments thus indicate that thorium D emits only one penetrating type. This conclusion was confirmed by examining the γ radiation from pure thorium D obtained by recoil on an aluminium plate. Although the effects were too small and the period of transformation too short for accurate measurements, the results clearly indicated that no appreciable amount of soft radiation was present under those conditions.

Analysis of the rays from Thorium (B + C + D).

In order to determine the penetrating power of the rays given out by thorium B, it was necessary to use sources containing the active deposit in equilibrium. We have seen above that two sources were prepared for this purpose. When the radiothorium source was employed, the preparation was contained in a watch-glass and covered with goldbeater's skin to prevent the escape of the emanation. The absorption curve, in aluminium, was determined up to a thickness of 11 cm. The curves obtained are shown in figs. 1 & 2 (Pl. XIX.). These curves were analysed by the method described in previous papers*. It will be seen that the curves can be separated into four exponential types corresponding to groups of rays of penetrating powers $\mu = 160$, $\mu = 32$, $\mu = 0.36$, and $\mu = 0.096$. The last group is of course that due to thorium D, and the remaining three are given out by thorium B.

Fig. 1 shows the analysis of the soft types of radiation. The logarithm curve for the second type of radiation $\mu = 32$ is shown in the figure. The points lie on a straight line showing that this radiation is absorbed exponentially. Fig. 2 brings out in a similar way the exponential absorption of the penetrating type of radiation $\mu = 0.096$, and also the relative effect in the experiments due to the penetrating radiation from thorium B, viz. $\mu = 0.36$. This latter radiation probably corresponds to that described by Marsden and Wilson† and by Hahn and Meitner‡, and noted in papers recently published.

* Rutherford & Richardson, *Phil. Mag.* xxv. p. 722 (1913).

† Marsden & Wilson, *Phil. Mag.* xxvi. p. 354 (1913).

‡ Meitner & Hahn, *Phys. Zeit.* xiv. p. 873 (1913).

Analysis of the γ rays from Mesothorium 2.

The mesothorium 2, prepared as described, was used for this experiment. The absorption curves obtained are shown in figs. 3 and 4. Analysis shows that the rays consist of two types, for which $\mu=26$ and $\mu=0.116$ respectively. Fig. 3 shows the method of analysis of the radiation $\mu=26$ and its exponential absorption by aluminium. The logarithm curve in fig. 4 shows the absorption for the penetrating radiation $\mu=0.116$.

Analysis of the γ rays from Actinium (B + C + D).

The γ rays emitted by the actinium products were examined by the same method as that adopted in the case of thorium. Owing to the short periods of actinium C (2.1 min.) and of actinium D (4.71 min.) it was impossible to complete the examination of the separate products with the small amount of material at our disposal*.

An actinium preparation was dissolved in hydrochloric acid, and the actinium X was separated by the ammonia method. In this manner the actinium X was obtained on a watch-glass mixed with a thin layer of material. The preparation was covered with goldbeater's skin as in the case of the radiothorium preparation in order to prevent the escape of the emanation. Shortly after the separation the actinium X is in equilibrium with its later products actinium (B + C + D), and the whole then decays with the comparatively long period of actinium X (10.2 days). The γ rays in this preparation arise from the active deposit, viz. actinium (B + C + D).

The absorption curve in aluminium of this preparation was obtained up to a thickness of 9 cm. Beyond 6 cm. the absorption is exponential with an absorption coefficient $\mu=0.198$. The curves obtained are shown in figs. 5 and 6. Analysis as in previous cases shows that the curves can be separated into exponentials with absorption coefficients $\mu=120$, $\mu=31$, $\mu=0.46$, and $\mu=0.198$ respectively. Fig. 5 shows the analysis of the softer portions of the radiation, and fig. 6 the separation of the two more penetrating groups. From analogy with the thorium series, there appears to be little doubt that the radiations $\mu=120$, $\mu=31$, and $\mu=0.46$ belong to actinium B, and that for which $\mu=0.198$ to actinium D.

* The actinium preparation used in these experiments was separated from radioactive residues (see Boltwood, Proc. Roy. Soc. A. lxxxv. 1911, p. 77) loaned to one of us by the Royal Society.

Analysis of the γ rays from Radioactinium.

Dr. Russell and Mr. Chadwick recently examined in this Laboratory the γ rays from radioactinium, which they found to be far greater in intensity than could be ascribed to excitation by α rays. An approximate analysis was made by them of the types of radiation present. In the course of our later experiments with actinium, the emission of an intense γ radiation from radioactinium was evident. The actinium X was successively separated from the radioactinium preparation, and after the second operation it was found that the γ radiation from the precipitate, viz. actinium and radioactinium, reached a definite minimum of activity. Measured in the ordinary electroscope, the γ -ray effect of the actinium and radioactinium was about 25 per cent. of the activity of the actinium in equilibrium with all its products. The actinium and radioactinium precipitate formed a comparatively thick deposit of several grams (about 10 grms.) in weight. Notwithstanding this comparatively thick layer, the presence of a considerable amount of soft radiation was evident. Analysis showed that the radiation from this material, which is to be ascribed to radioactinium, consists of two distinct types for which $\mu=25$ and $\mu=190$. The absorption curves obtained are shown in figs. 7 and 8. The γ -ray effect due to the more penetrating type was less than 2 divs. per min. under the experimental conditions, and it was consequently difficult to determine its absorption coefficient with as great an accuracy as was desired. An examination of the rise curve of the actinium and radioactinium preparation showed that the radiation could not be ascribed to some actinium X which had not been separated. In addition it is seen that the soft type $\mu=25$ is quite distinct from the corresponding radiation from actinium B, viz. $\mu=31$. It is of interest to observe that the hard type of radiation from radioactinium appears to be slightly more penetrating than that emitted from actinium D.

Summary.

For convenience, the types of γ rays emitted from all the products so far examined are included in the following table. In order to complete the series it will be necessary to examine the types of γ rays emitted by uranium X. It is intended to continue the experiments in this direction.

Element.	Atomic weight.	Absorption coefficient μ in aluminium.	Mass. absorption coefficient μ/d in aluminium.
Radium B.....	214	230 } (cm.) ⁻¹ 40 } 0.51 } "	85 } (cm.) ⁻¹ 14.7 } " 0.188 } "
Radium C.....	214	0.115 } "	0.0424 } "
Radium D	210	45 } " 0.99 } "	16.5 } " 0.36 } "
Radium E	210	similar types to D but very feeble.	
Mesothorium 2 ...	228	26 } (cm.) ⁻¹ 0.116 } "	9.5 } " 0.031 } "
Thorium B	212	160 } " 32 } " 0.36 } "	59 } " 11.8 } " 0.13 } "
Thorium D	208	0.096 } "	0.035 } "
Radioactinium	25 } " 0.190 } "	9.2 } " 0.070 } "
Actinium B	120 } " 31 } " 0.45 } "	44 } " 11.4 } " 0.165 } "
Actinium D	0.198 } "	0.073 } "

It will be seen that the γ rays from radioactive products can be conveniently divided into four types :—

(1) The soft radiations from the B products which vary from $\mu=120$ to $\mu=230$.

(2) A more penetrating type varying from $\mu=26$ to $\mu=45$, probably corresponding to characteristic radiations of the "L" series.

(3) A penetrating type from the B products varying from $\mu=0.36$ to $\mu=0.51$.

(4) A very penetrating type varying from $\mu=0.115$ to $\mu=0.198$, probably corresponding to characteristic radiations of the "K" series.

Types (1) and (2) are much less penetrating than the X rays from an average tube, although the work of Bragg* and Moseley and Darwin † has clearly shown that types of radiation similar in penetrating power to (2) are present in X rays generated with a platinum anticathode. Using a hard bulb and a consequent very high voltage

* Bragg, Proc. Roy. Soc. A. lxxxviii. p. 428 (1913).

† Moseley & Darwin, Phil. Mag. xxvi. p. 210 (1913).

(100,000 volts), S. J. Allen * showed that X rays could be produced of penetrating power about corresponding to type (3). Type (4) is more penetrating than any X rays produced or likely to be produced in X-ray tubes.

Thorium D emits the most penetrating type of γ rays known, while radium C and mesothorium 2 come next with radiations of nearly equal penetrating power. Actinium products, as has long been known, emit less penetrating types of radiation than radium or thorium products. The penetrating radiation from radium D has no apparent analogy with that emitted by any other product.

General Considerations.

In the above table we have included the types of primary γ rays emitted by radioactive substances. In every case the emission of the γ rays observed is accompanied by a well-marked primary β radiation. As we have already pointed out in our experiments on radium D and radium E †, there does not appear to be any obvious connexion between the relative intensity of the β and γ rays. For example, consider the case of radium D and radium E. On the one hand, radium D emits a comparatively feeble β radiation, shown by Hahn ‡ to consist of two groups of low velocity but a well-marked γ radiation; and on the other, radium E emits an intense β radiation comprising particles projected with nearly the velocity of light, but gives a γ radiation exceedingly feeble in quantity compared with that from radium D.

The experiments of Hahn, v. Baeyer and Meitner have shown that practically all the β -ray products emit a number of distinct groups of β rays of definite speed. The only exception to this is radium E which gives a continuous spectrum of β rays in which no evidence of groups has yet been observed. It should be mentioned also that no evidence of groups has so far been observed in the β rays of uranium X, but more experiments are required on this point. It may prove significant that radium E, which shows no sign of definite groups of β rays, should be the only β -ray product which emits γ rays exceedingly feeble in intensity.

In addition to these primary γ rays of marked intensity, Mr. Chadwick and Dr. Russell § have recently drawn

* S. J. Allen & E. J. Lorentz, *Phys. Rev.* i. ser. 2, p. 35 (1913).

† Rutherford & Richardson, *Phil. Mag.* xxvi. p. 324 (1913).

‡ Hahn, Baeyer & Meitner, *Phys. Zeit.* xii. p. 378 (1911).

§ Chadwick & Russell, *Proc. Roy. Soc. A.* lxxxviii. p. 217 (1913).

attention to the fact that substances which emit α rays also emit a γ radiation of feeble intensity. This has been shown to be the case for the α -ray substances ionium, radiothorium, and polonium.

They have also examined the γ radiation from radium itself, which is also known to emit a weak β radiation. With the exception possibly of radium, this γ radiation observed from α -ray products has probably an entirely different origin from the intense primary γ radiation from the β -ray products. It would appear to be excited in the radioactive atoms by the escape of α particles. In their experiments on the α -ray product ionium, Chadwick and Russell have drawn attention to the fact that the softer types of radiation predominate. This is the exact opposite of the primary γ -ray products, where the penetrating types of radiation are relatively far more intense.

It is of interest to compare the types of primary γ rays emitted by different radioactive products. In the first place, it is clear from the table that each of the products radium B, thorium B, and probably actinium B, which occupy the same relative position in the radioactive series and have very similar if not identical chemical properties, emit three distinct types of γ radiation which appear to be closely analogous in relative penetrating power. Similar results appear to hold for radium C, thorium D, and actinium D, each of which emits only one penetrating type of γ radiation. Neither of the two products radium D and radium E corresponds in radioactive or chemical properties with any member of the thorium or actinium series and also shows no close analogy in their types of radiation.

In a previous paper * one of us has suggested that the types of γ rays emitted by radioactive substances should correspond to one or more of the types of characteristic radiation excited in the atom by the escape of β particles. For example, the single type of γ radiation from radium C and thorium D has about the penetrating power to be expected for a radiation of the "K" series found by Barkla †.

It will be observed from the table that all the B products emit a soft type of radiation which is on an average much less penetrating than ordinary X rays. From a comparison of the results given by Chapman ‡ it would appear that the radiations from radium B, $\mu=40$, from thorium B, $\mu=32$,

* Rutherford, *Phil. Mag.* xxiv. p. 453 (1912).

† Barkla, *Phil. Mag.* xxii. p. 396 (1911).

‡ Chapman, *Proc. Roy. Soc. ser. A.* lxxxvi. p. 439 (1912).

from actinium B, $\mu=31$, and from mesothorium 2, $\mu=26$, belong to the "L" series of Barkla. This type of radiation seems very persistent in all except the three products radium C, thorium D, and actinium D. It should be pointed out, however, that there appears to be no very close connexion between the penetrating power of the radiation and the atomic weight. For example, radium B of atomic weight 214 gives a radiation for which $\mu=40$, whilst thorium B of still lower atomic weight 212 gives a more penetrating radiation, $\mu=32$. This peculiarity holds not only for the soft radiations but also for the hard types emitted by the B products. If the softer types of radiation do belong to the "L" series, it would appear that the general rule connecting penetrating power and atomic weight may hold approximately over wide ranges but not necessarily for products whose atomic weights differ only slightly from one another. It is difficult to offer any explanation why the B products should give three types and the successive products only one type. It should be pointed out, however, that the β rays from the B products are on the average much less penetrating than the β rays from the following products, and have consequently a much better chance of exciting the softer types of γ radiation, that is, the radiations of longer wave-length. Also it should be noted that the expulsion of a long range α particle either accompanies or precedes immediately the penetrating γ radiation from these products.

During the present year, Russell*, Fajans†, and Soddy‡ have independently discussed the question of the chemical properties of the numerous radioactive products, and have shown that the sequence of chemical properties in a radioactive series follows a simple rule when the types of emitted radiation are taken into account. According to some of these views, the B products are to be regarded as chemically identical and inseparable from one another, although they may differ by about two units in their atomic weights. If we take the view that the atom consists of a positively charged nucleus of small dimensions surrounded by rings of electrons which can be set in vibration, it would seem probable that an identity of chemical nature would involve an identity in the electronic distribution and of the magnitude of the charge on the nucleus. If the γ rays set up are due to the vibration of the electronic systems, it would be anticipated that the types of γ rays emitted would be identical for such products. While, as we have previously

* Russell, *Chem. News*, cvii. p. 49 (1913).

† Fajans, *Phys. Zeit.* iv. p. 136 (1913).

‡ Soddy, *Chem. News*, cviii. p. 168 (1913).

pointed out, there is an undoubtedly close analogy between the B products, not only in the types of radiation but also in the relative penetrating power, the differences in their penetrating power are sufficiently marked to indicate a real difference in the wave-length of the radiation emitted and one which cannot be attributed to experimental error.

It is of interest to examine whether a comparison of the types and penetrating power of the radiations from the thorium and actinium products gives any indication as to the atomic weight of the latter. It has already been mentioned that the "L" type of radiation seems to be predominant for most of the products, and for this radiation there is a close agreement between the penetrating powers of the radiations emitted by analogous products. For example, actinium B emits a radiation for which $\mu=31$, and a corresponding radiation $\mu=32$ is given out by thorium B. The radiation $\mu=25$ from radioactinium also resembles closely the radiation from mesothorium 2, $\mu=26$. Considering the very close analogy in chemical and radioactive properties of the thorium and actinium series, it is reasonable to suppose that those bodies which emit similar types of radiation of nearly equal penetrating power have nearly the same atomic weight. For example, by considering the number of α -ray products it can be estimated that thorium B has an atomic weight 212. We should expect actinium B to have an atomic weight nearly the same. In the same way we should expect radioactinium and mesothorium 2 to have nearly equal atomic weights. Calculating backwards by a consideration of the number of α -ray products, it can be deduced that the atomic weight of actinium should be (1) 228, from comparison of the B products; (2) 228 from comparison of radioactinium with mesothorium 2.

It is quite probable from other analogies, that the actual atomic weight might be two units greater or less than the above value. In the one case, the atomic weight 230 would indicate that actinium was derived from uranium after the expulsion of two α particles, and the other that it arose from ionium. On this point of view radium itself does not seem admissible as a possible origin of actinium, and this is supported by the recent experiments of Soddy*. The deduction that actinium is derived from uranium seems the more probable, and several suggestions of this possibility have already been made †.

* Soddy, *Nature*, xci. p. 634 (1913).

† Boltwood, *Amer. Journ. Sci.* xxv. p. 269 (1908). Hahn & Meitner, *Phys. Zeit.* xvi. p. 752 (1913). Antonoff, *Phil. Mag.* xxii. p. 419 (1911).

The other more penetrating types of radiation from the actinium and thorium products do not appear to be directly comparable. For example, the hard radiations from thorium D and actinium D show wide differences in penetrating power.

When the types of γ radiation emitted not only by all β -ray products but also by all α -ray products are known, very valuable data will have been obtained for throwing light not only on the modes of vibration of the radioactive elements but also on their atomic constitution.

University of Manchester,
October, 1913.

LXXXIII. *A Method for the Determination of the Molecular Weights of the Radioactive Emanations with Application to Actinium Emanation.* By E. MARSDEN, M.Sc., and A. B. WOOD, M.Sc., University of Manchester*.

IN all the methods previously employed to determine the molecular weights of the emanations from their rates of diffusion or effusion †, the results have been dependent on a comparison of the corresponding rate for some other gas. Further, the measurements in most cases are undoubtedly affected by the fact that it is impossible to deal in this way with the emanations except when mixed in extremely small proportion with other gases. In the method to be described both these objections are avoided by working at such low pressures that the molecules have a mean free path large in comparison with the size of the containing vessel, and by using definite kinetic theory data not involving comparison with other gases.

Suppose we have two vessels I. and II. of volumes V_1 and V_2 separated by a hole of area A and containing N_1 and N_2 molecules per c.c. respectively. Then if Ω is the mean molecular velocity, it can be calculated from the kinetic theory that the number of molecules from I. passing through the opening will be $\frac{1}{4} N_1 \Omega A$ ‡, and the number returning from II. will be $\frac{1}{4} N_2 \Omega A$. Consequently, on the whole $\frac{1}{4} \Omega A (N_1 - N_2)$ molecules will cross from I. to II. per second.

Suppose that molecules of actinium emanation are supplied at a constant rate in I. and allowed to pass into II. Then a

* Communicated by Prof. E. Rutherford, F.R.S.

† E. Rutherford, "Radioactive Substances," p. 379 *et seq.*

‡ M. Knudsen, *Ann. d. Physik*, xxviii. p. 999 (1909).

steady state will be reached when the number passing through the hole per second is equal to the number disintegrating in II. Assuming actinium emanation to be monatomic and to have a disintegration constant λ , we have

$$\frac{1}{4} \Omega A (N_1 - N_2) = \lambda N_2 V_2. \quad \dots \quad (1)$$

The ratio N_1/N_2 can be obtained by allowing the process to go on so long that the active deposit is in equilibrium with the emanation in each chamber, so that on removing the source of emanation the ratio of the amounts of active deposit is equal to the ratio of the numbers of emanation atoms initially present. In this way Ω can be obtained, and as $\Omega = 14546 (\theta/M)^{\frac{1}{2}}$ where θ is the absolute temperature, the molecular weight M can be calculated, *i. e.*

$$M = \left[3636 \cdot 5 \left(\frac{N_1}{N_2} - 1 \right) \cdot \frac{A}{V_2 \lambda} \right]^2 \theta. \quad \dots \quad (2)$$

Experimental Method.

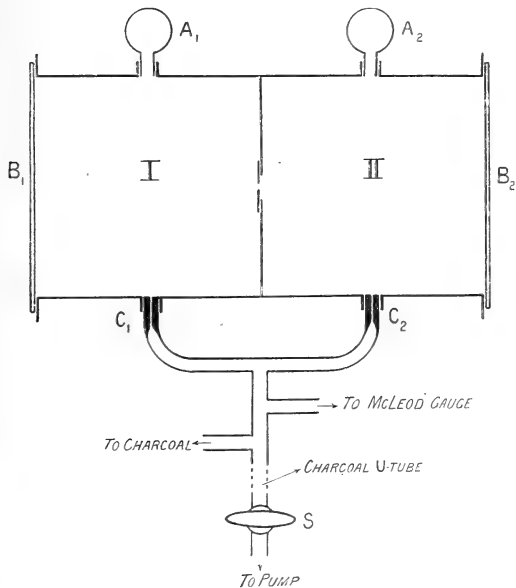

The plan of the apparatus used is shown in the figure. The arrangement consists essentially of a brass box divided symmetrically into two cubes of 6.5 cm. side by a partition having a hole of the order 1 sq. mm. in thin aluminium.

The source of actinium was placed in a side tube A_1 , A_2 being a similar dummy tube. The ends were closed airtight by plates B_1 and B_2 fastened on with hard wax. Exhaustion was carried out through side tubes C_1 and C_2 , which for 1 cm. length nearest the apparatus had a bore of about 0.5 sq. mm. By means of a mercury pump the pressure was reduced to below 1 mm. Hg, and the stopcock S closed. Dewar flasks containing liquid air were then placed round the charcoal bulb and U-tube, so as to reduce the pressure well below 1/1000 mm. and ensure the mean free path of the molecules being large compared with the size of the vessel. In this way the effusion of the emanation is not influenced by the presence of the air molecules. The charcoal U-tube was used to prevent any vapour from the grease of the stopcock entering the chambers.

The apparatus was kept evacuated for three hours so that the active deposit attained practical equilibrium. The plates B_1 and B_2 were then quickly taken off, and loose brass plates which fitted closely and covered the bases of the two chambers were removed for activity measurements. These measurements were made in an ordinary α -ray electroscope. As the apparatus was made as nearly symmetrical as possible, the ratio of the activities gives the ratio of N_1/N_2 in equation (2), *i. e.* the ratio of the numbers of emanation atoms present per c.cm. in the steady state.

The following are the data for a set of experiments, nos. 4, 5, and 6 being made with the bulb containing actinium and the dummy bulb interchanged, so as to eliminate any slight dissymmetry.

$$A = 0.1022 \text{ sq. cm.} \quad V_1 = V_2 = 270 \text{ c.cs.}$$

$$\lambda = 0.178 \quad \theta = 19^\circ\text{C.} = 292^\circ \text{ absolute.}$$

Ratio of Activities.

(1) 2.16	(4) 2.19
(2) 2.13	(5) 2.12
(3) 2.18	(6) 2.18

$$\text{Mean} = 2.16.$$

$$\therefore M = \left[3636.5 (2.16 - 1) \frac{0.1022}{270 \times 0.178} \right] \times 292 = \text{eqn. (2)}$$

$$= 236.$$

Further experiments were made with a hole of only

·004075 sq. cm. area. The mean molecular weight calculated from the result with this hole was 228. The difference between this and the former value is well within the experimental error, considering that the calculated value depends on the squares of A and $(N_1/N_2 - 1)$.

The chief importance of a measurement of the atomic weight of actinium emanation is that it allows the atomic weight of actinium itself to be estimated, and thus should throw light on the question of the origin of actinium. The experiments of Boltwood* show that the amount of actinium, measured by its activity, present in uranium minerals, is approximately proportional to the percentage of uranium. This indicates that actinium, like radium, must belong to the uranium series and stand in some genetic relation with it. From the relative activities of the actinium and uranium present, however, Rutherford† has concluded that actinium must arise as a branch product at some point of the series, and calculates the ratio of the number of atoms on the branch to the number on the main family to be ·08. Three possible products of the series have been suggested as the parent of actinium, namely uranium X, radium itself, and radium C‡. The evidence with regard to the former is purely theoretical and is derived from considerations of the valency of actinium. The evidence as to a branch product in radium is obtained from the presence of a very feeble soft β radiation in that product, which may be presumed to come from the atoms giving rise to the branch. With regard to radium C, the fraction of atoms on the radium C₂ branch appears to be only of the order 3/10000, and further, Fajans failed to detect actinium in the active deposit of radium. A further possible source of actinium is that it may be derived from the branch product Ur Y, found by Antonoff§. The existence of this product has, however, recently been questioned by Fleck||.

Taking the mean value 232 obtained above as the atomic weight of actinium emanation and adding 8 units for the α particles of radio-actinium and actinium X, we obtain a value 240 for the atomic weight of actinium. This would place actinium just outside the uranium series, as the atomic weight of uranium is only 238·5.

* Boltwood, Amer. Journ. Sci. xxv. p. 269 (1908).

† Cf. 'Radioactive Substances,' p. 522.

‡ Hahn & Meitner, *Phys. Zeit.* xiv. p. 758 (1913); Soddy, Chem. News, cvii. p. 97 (1913); Fleck, Phil. Mag. xxvi. p. 534 (1913); Fajans & Göhring, *Phys. Zeit.* xiv. p. 879 (1913).

§ Antonoff, Phil. Mag. xxii. p. 431 (1911); xxvi. p. 332 (1913).

|| Fleck, Phil. Mag. xxv. p. 710 (1913).

However, our result can only be taken as preliminary. The calculated value, as will be seen from equation (2), depends on the square of λ , and this constant is only known to within a few per cent. We hope to make experiments to determine λ more exactly and also to make a fuller investigation of the effusion rate.

We are greatly indebted to Dr. N. Bohr for drawing our attention to this method of determining molecular weights, and to Prof. E. Rutherford for his kind interest in the experiments.

LXXXIV. *On the Motion of Long Air-bubbles in a Vertical Tube.* By Prof. A. H. GIBSON, D.Sc., *University College, Dundee**.

[Plate XX.]

1. Introduction.
2. Experimental data.
3. Velocity of long bubbles.
4. Ripple formation on surface of a long bubble.
5. Limiting length for stability of motion.

1. **T**HE motion of an air-bubble rising, under gravity, through the liquid in a vertical tube depends largely on its dimensions, both absolute and relative to that of the tube.

If the bubble is very small its form is approximately spherical and its motion steady. As the size is increased the shape changes, becoming more and more contracted in a vertical direction, while the curvature of the lower surface becomes much less than that of the upper surface. When in a tube of moderate dimensions, these changes become accentuated. The motion of such a bubble, of diameter between one-fourth and two-thirds that of the tube, is very irregular. Not only does it zigzag across the tube from side to side, but its motion is accompanied by violent oscillations about a horizontal axis which show, in a striking manner, the periodic variation of the magnitude and distribution of the pressure on its lower face due to eddy formations in its rear. As the size is further increased the irregularities are diminished, until when the diameter is about $\cdot 75$ times that of the tube the bubble begins to adopt a more or less cylindrical form with an ogival head and flat stern, and the motion becomes steady. Any further increase in the volume is mainly effective in increasing the length of the cylindrical portion of the body, the form of the head remaining sensibly unchanged,

* Communicated by the Author.

and the mean diameter, although increasing with length, not altering greatly.

The body of the bubble, although for convenience termed cylindrical, is not actually of the same diameter throughout, but gradually increases to a maximum at its lower extremity.

If the bore of the tube exceeds about 1 cm., such a bubble shows a beautiful series of well-defined waves or ripples around the lower portion of its barrel (Pl. XX. figs. 2 & 3). These are stationary relative to the surface of the bubble, and, when the length of the latter does not exceed the bore of the tube, are of comparatively large amplitude and length and extend over the whole length of the bubble. As the length increases, the wave-length and amplitude and the extent of surface covered by the ripples diminish rapidly, while with a given length of bubble the wave-length diminishes with an increase in the bore of the tube. Thus with a bubble 5 cm. long experiment shows that the wave-length approximates to .075 cm. in a tube of 1.25 cm. bore; to .05 cm. with a bore of 2.5 cm.; and to .045 cm. with a bore of 5 cm.

If the bore is less than about 1 cm. the ripple formation is somewhat peculiar. Immediately ahead of the stern of the bubble a ripple consisting of a single depression of comparatively large amplitude and length (Pl. XX. fig. 1) is formed, and for lengths greater than about two diameters even this is not fully developed. Where the bubble passes any slight roughness in the interior surface of the tube, however, a series of true ripples of very much smaller pitch make their appearance.

2. *Experimental Data.*—With a view of examining these phenomena in the case of air-bubbles in motion through water, and of comparing experimental results with those deduced from calculations, the experiments to be described have been carried out on a series of glass tubes with diameters ranging from .420 cm. to 7.78 cm. Each tube was mounted vertically; an air-bubble was introduced by means of a rubber bulb at its lower end; and, when the motion had become steady, the time taken to traverse a known distance was measured by chronograph. In the case of four tubes, of diameters .788, 1.680, 2.695, and 5.09 cmm., instantaneous photographs having an exposure of 1/1000 second were taken of bubbles of various lengths up to about 8 cm. Figs. 1-3 are typical of these. The resulting negatives were then projected on to a screen, and the wave-lengths were measured from the magnified image thus obtained.

The temperature of the water during the experiments

ranged from 9° C. to 11° C. At the mean temperature of 10° C., the coefficient of viscosity μ , calculated from Poiseuille's formula

$$\mu = \frac{0.000181}{1 + 0.03368t + 0.00021t^2},$$

is 0.0001333 grammes wt. per sq. cm., while the value of the surface-tension T at the boundary surface of air and water, as calculated from the relationship

$$\begin{aligned} T &= 0.0752(1 - 0.00187t), \\ &= 0.0738 \text{ grammes per centimetre.} \end{aligned}$$

These values of μ and of T have been used throughout the calculations.

3. *Velocity of Long Bubbles.*—The experiments showed the somewhat unexpected result that if the bubble is so long as to adopt a cylindrical form, *i. e.* for lengths greater than the bore of the tube, the mean velocity is sensibly independent of the length within the limits of length (up to about 20 diameters in the smaller tubes) investigated. The mean results of these experiments are as follows:—

TABLE I.
Velos.—cm. per sec.

Diam. of tube. cm.	Length of bubble in terms of bore of tube.						Mean velocity.
	1.	2.	3.	5.	10.	20.	
0.420							0
0.536	...	0.276	0.277	0.281	0.277	...	0.278
0.560	3.36	3.36	3.35	3.36	3.36
0.788	3.33	3.23	3.23	3.21	3.21	3.19	3.23
1.321	10.2	10.3	10.3	10.3	10.3	10.3	10.3
1.680	15.0	15.0	15.0	15.0	15.0	15.1	15.0
1.796	16.1	16.3	16.3	16.3	16.4	...	16.3
2.695	23.4	23.4	23.4	23.3	23.4
5.09	29.9	29.9	29.9
7.78	32.9	32.9	32.9

After trying various systems of plotting, it was found that these results are very nearly represented by the relationship

$$V = 34.6 - \frac{114.0}{d^2 + 3.012} \text{ cm. sec. , . . . (1)}$$

where d is the diameter of the tube in cm.

Table II. shows values of V calculated by this formula against those obtained by experiment.

TABLE II.

Diam. cm.	.536	.560	.788	1.321	1.680	1.796	2.695	5.09	7.78	
Velocity cm. per sec.	measured	.028	.336	3.23	10.3	15.0	16.3	23.4	29.9	32.9
	calculated	.031	.320	3.20	10.6	15.0	16.3	23.5	29.6	32.8

When $d = .535$ cm. the formula makes $V = 0$. As indicated in Table I., no motion is possible in a tube .42 cm. in diameter, and further investigation showed that this is also the case with a diameter of .51 cm. Under these circumstances there appears to be no connexion between the films forming the upper and lower surfaces of the bubble. Some idea of the limiting diameter at which motion becomes possible may be obtained, independently, from a consideration of the conditions of equilibrium of the fluid surrounding the head of the bubble when motion is on the point of beginning. At this instant the upper surface of the bubble becomes very nearly spherical and of approximately the same radius as the tube. If R be the radius of the tube, the difference between the internal and external pressures at its apex, on these assumptions, is $2T/R$, while at its point of tangency the difference is T/R . Expressing the fact that the difference of external pressure at these points, due to the difference of level, is R/ϖ , where ϖ , the weight of water per cub.cm., is unity, we get

$$R - \frac{2T}{R} = - \frac{T}{R};$$

$$\therefore R = \sqrt{T} = \sqrt{.0738} \\ = .2718 \text{ cm.}$$

a value in fair agreement with that (.2675 cm.) deduced from experiment.

4. *Ripple Formation on the Surface of a Bubble.*—The system of ripples on the surface of a long bubble appears to be analogous to that found at the upstream side of an obstacle piercing the surface of a running stream, the disturbance produced by the sudden change of section and of velocity in the rear of the bubble being analogous to that due to the presence of the obstacle in the latter case.

In the case of wave-formation on the walls of a vertical

cylindrical air column of radius r , surrounded by an inviscid liquid whose boundaries are remote, the relationship between the wave-length l , and the velocity v of flow past the surface, is given by

$$v^2 = -\frac{r}{k} \cdot \frac{\phi'(kr)}{\phi(kr)} \left\{ k^2 r^2 - 1 \right\} \frac{gT}{\omega r^3}, \dots \quad (2)^*$$

where $k = \frac{2\pi}{l}$.

A few preliminary measurements of wave-length showed that for all the tubes in which the series of ripples was well defined the value of kr was large, ranging from a minimum of about 40 in the shortest bubbles in the tube .788 cm. diameter, to over 600 in the tube 5.09 cm. diameter. For large values of kr , the function $\phi(kr)$ in formula (2) is defined by

$$\phi(kr) = -\left(\frac{\pi}{2kr}\right)^{\frac{3}{2}} e^{-kr} \left\{ 1 - \frac{1^2}{1 \cdot (8 \cdot kr)} + \frac{1^2 \cdot 3^2}{1 \cdot 2 \cdot (8kr)^2} - \frac{1^2 \cdot 3^2 \cdot 5^2}{1 \cdot 2 \cdot 3 \cdot (8kr)^3} + \dots \right\},$$

while, writing $\phi'(kr) \div \phi(kr)$ as $F(kr)$, calculations show that $F(kr)$ has values ranging from approximately -1.01 when $kr=40$, to -1.001 when $kr=600$.

Writing (2) as

$$v^2 = -F(kr) \left\{ k - \frac{1}{kr^2} \right\} \frac{gT}{\omega}, \dots \quad (3)$$

it appears that the error involved in taking $F(kr) = -1$ and in neglecting the additive term $\frac{1}{kr^2}$ is, for these experiments, in no case greater than 1 per cent., and is, in the great majority of cases, much less than this. Since this is in general not greater than the errors of measurement, these simplifications have been adopted in the calculations.

Equation (3) then becomes

$$v^2 = \frac{kgT}{\omega} = \frac{2\pi gT}{\omega l}, \dots \quad (4)$$

the formula for the velocity of ripples on a flat sheet of deep water, with only surface-tension operative. Where the depth of water " h " is not great comparable with the wave-length, it may readily be shown that (4) becomes

$$v^2 = \tanh \frac{2\pi h}{l} \left\{ \frac{2\pi gT}{\omega l} \right\} \dots \quad (5)$$

* Sci. Papers, Rayleigh, vol. iii. p. 595.

While there is ample evidence as to the validity of formulæ (4) and (5) in fairly deep water, where viscosity has little apparent effect in modifying wave-length and velocity, it is not obvious that this will be true of the case in question, where the depth of water on which the ripples are formed is extremely small, and where, in consequence, the effect of viscosity and of the solid boundaries might be expected to be more pronounced.

With a view of investigating this point the following series of experiments was carried out. In these a steady stream of water from a vertical nozzle was allowed to impinge on the centre of a circular horizontal glass plate 20 cm. in diameter, flow taking place radially outwards in all directions. The discharge was caught and weighed. The depth of the sheet of water was measured at a series of radii by means of a spherometer with a needle-point which was gradually lowered to make contact with the fluid surface. Ripples were then formed at these same radii by means of a needle-point, and their length was measured by microscope. The estimated depth of water is probably correct to within about .015 mm., and the estimated wave-length within about .025 mm.

In this case both gravity and surface-tension are operative, and in deep water formula (4) becomes

$$v^2 = \frac{2\pi g \Gamma}{\omega l} + \frac{gl}{2\pi}, \quad \dots \dots \dots (4')$$

while if the depth is moderate compared with the wave-length (5) becomes

$$v^2 = \tanh \frac{2\pi h}{l} \left\{ \frac{2\pi g \Gamma}{\omega l} + \frac{gl}{2\pi} \right\}. \quad \dots \dots \dots (5')$$

For values of $h \div l$ greater than one half, $\tanh \frac{2\pi h}{l}$ is nearly equal to unity, and the two formulæ become sensibly identical. Formula (5') has been used to calculate wave-lengths, h being taken as the depth of the undisturbed water, with the following results.

Series A.

No.....	1.	2.	3.	
Mean vel. cm. per sec....	53.7	62.2	74.0	
h cm.0208	.0198	.0183	
l cm. {	measured120	.095	.073
	calculated122	.096	.076
$\frac{h}{l}$173	.195	.244	

Series B.

No.	1.	2.	3.	4.	5.	6.	7.	8.	9.	10.
Vel. cm. sec. ...	43·1	54·5	67·7	77·8	87·2	106·1	125·8	149·0	197	56·7
h cm.	·0546	·052	·0546	·057	·0488	·054	·0540	·0546	·069	·132
l cm. {	measured	·175	·150	·109	·086	·070	·048	·037	·028	·021
	calculated	·180	·155	·112	·086	·070	·047	·038	·029	·022
$\frac{h}{l}$	·303	·348	·50	·66	·69	1·12	1·45	1·88	3·30	·852

From these results it appears that for such depths of water which, as will appear, are less than those obtaining in the walls of the bubbles formed in all the tubes of diameter exceeding $\cdot78$ cm., the modifying effect of viscosity is very small, nor is this appreciably more effective as a disturbing factor at the smallest depth ($\cdot02$ cm.) than in those ($\cdot05$ to $\cdot06$ cm.) more than twice as great. The mean difference between calculated and observed results is about 1·5 per cent., the measured lengths being in general less than those calculated. Where the ratio of $h \div l$ is greater than $\cdot5$ the agreement is even closer, and as in the case of the bubbles this ratio is in general, as will appear, greater than this the simple formula (4), modified where necessary as in (5), will be adopted in all calculations.

Before these formulæ can be applied to determine the wave-length for any particular bubble it is necessary, however, to determine the radius r and the velocity v of the surrounding fluid, at the point of wave-formation.

These may be deduced with a fair degree of approximation from general hydrodynamical considerations, as follows.

If suffixes (1) and (2) refer to points immediately ahead and astern of the bubble whose overall length is L cm., the equation of energy for flow past the bubble becomes

$$\frac{p_1}{\omega} + L = \frac{p_2}{\omega} + \left\{ \begin{array}{l} \text{Loss accompanying change of} \\ \text{kinetic energy of flow past} \\ \text{maximum section of bubble} \\ \text{into pressure energy in rear} \\ \text{of bubble.} \end{array} \right\} + {}_1H_2, \quad (6)$$

where ${}_1H_2$ is the resistance to flow through the annular space between bubble and tube-wall. Except where the bubble is very long (at least 18 diameters) the clear glassy appearance

of its walls shows that this flow is steady, *i. e.* unaccompanied by eddy formation, and under these circumstances the velocity at any radius x may readily be shown to be given by

$$u = \frac{1}{4\mu} \frac{dp}{dL} \left\{ R^2 - x^2 + B \log x + C \right\}, \quad \dots \quad (7)$$

where R is the radius of the tube,

„ $\frac{dp}{dL}$ is the pressure drop per unit length of the annulus, necessary to maintain steady flow against viscous resistance.

Determining the constants B and C to satisfy the conditions that $u=0$ when $x=R$, and $\frac{du}{dx}=0$ when $x=R'$, *i. e.* at the surface of the bubble, this becomes

$$u = \frac{1}{4\mu} \frac{dp}{dL} \left\{ R^2 - x^2 + 2R'^2 \log \frac{x}{R} \right\}. \quad \dots \quad (8)$$

If x is nearly $=R$, say $x=R-z$ where $\frac{z}{R}$ is small, this may be written

$$\begin{aligned} u &= \frac{1}{4\mu} \frac{dp}{dL} \left\{ 2Rz - z^2 - 2R'^2 \left(\frac{z}{R} + \frac{z^2}{2R^2} + \dots \right) \right\} \\ &= \frac{1}{4\mu} \frac{dp}{dL} \left\{ 2Rz \left(1 - \frac{R'^2}{R^2} \right) - \left(1 + \frac{R'^2}{R^2} \right) z^2 + \dots \right\}, \quad \dots \quad (9)^* \end{aligned}$$

and as in these experiments, as will be shown later, the value of $\frac{z}{R}$ ranges from about .07 to a maximum of about .16, expression (9) affords a sufficiently close approximation.

If R' be the radius of the bubble at its maximum cross-section, the kinetic energy of flow past the minimum section of the annulus is given by

$$\frac{\bar{w}}{2g} \cdot 2\pi \int_0^{R-R'} (R-z)u^3 dz \text{ per second,}$$

while if v be the mean velocity of flow past this cross-section, the apparent kinetic energy is measured by

$$\frac{\bar{w}}{2g} \pi (R^2 - R'^2) v^3 = \frac{\bar{w}}{2g} v^2 \text{ per c.c.}$$

* For the suggestion embodied in expressions (8) and (9), as for many other helpful suggestions in the mathematical portion of the paper, the author would express his indebtedness to Professor Horace Lamb.

The ratio, k , of the true to the apparent kinetic energy depends on the value of $\frac{z}{R}$. It becomes $\frac{\pi}{2}$ when this fraction is very small, and has a value of 1.58 when $\frac{z}{R} = .05$, and of 1.61 when $\frac{z}{R} = .15$. Over the range of values of $\frac{z}{R}$ found in the experiments, its value may be taken as 1.60, with an error not exceeding 1 per cent.

Experiments* show that where the velocity of a stream of water is reduced by a gradual enlargement of its cross-section, the loss of energy accompanying the change from kinetic to pressure energy is given by $k' \frac{(v_1 - v_2)^2}{2g}$, where v_1 is the initial and v_2 the final velocity, and that if the angle of divergence of the boundaries is greater than about 40° , k' is greater than unity. An examination of photographs of long bubbles shows that the effective angle of divergence of the streams leaving the annulus is in the neighbourhood of 60° , for which angle k' is about 1.25, so that in this case the total loss due to the production of kinetic energy is given by $\left(kk' \frac{v^2}{2g}\right)$, where kk' or k'' will have a value somewhat greater than 1.60×1.25 or 2.0.

The exact value of this constant cannot be predetermined with any great degree of accuracy. Under the conditions outlined it cannot differ greatly from 2.0, and in the following calculations has been taken as having this value.

The viscous loss in the annulus is, except in very long bubbles, a small fraction of that due to eddy formation in the rear of the bubble. An approximation to its value may be obtained by considering that since the mean velocity in the annulus at the minimum section is given by

$$\frac{2\pi \int_0^{R-R'} (R-z) u dz}{\pi(R^2 - R'^2)},$$

we have from (9)

$$\frac{dp}{dL} = \frac{v \cdot \mu R}{\int_0^{R-R'} (R-z) z dz}.$$

If A is the cross-section of the tube, and a' that of the

* Trans. Roy. Soc. Edin. vol. xlviii. pt. 1, p. 97 (1911).

bubble at its maximum section, *i. e.* at its lower end where its velocity is V , on writing $V = \frac{v(A-a')}{a'}$, and simplifying,

this gives very approximately, when $\frac{z}{R}$ is small (say of the order of 0.1),

$$dp = \frac{18\pi V a' \mu}{\varpi(A-a')^2} \cdot dL \text{ cm.} \dots \dots (10)$$

With a cylindrical bubble of this area throughout, the loss of head in overcoming viscous flow over its whole length would be given by

$${}_1H_2 = \frac{V a'}{\varpi} \frac{18\pi \mu}{(A-a')^2} \cdot L \text{ cm.} \dots \dots (11)$$

Actually, however, the loss from the apex to the point at which the bubble becomes sensibly cylindrical, and at which its area is a'_b , must be negligibly small, while if L' be the length from this point to the base, the true loss is given by

$${}_1H_2 = \frac{V a'}{\varpi} \cdot 18\pi \mu \int_0^{L'} \frac{dL}{(A-a)^2}.$$

Writing, as appears to be justified by observation, $a = a' - kl$, this becomes, on integrating :

$${}_1H_2 = V a' \frac{18\pi \mu}{\varpi} \cdot \frac{L'}{(A-a')(A-a_b)} \dots \dots (12)$$

In order to simplify the resultant calculations it becomes desirable to express ${}_1H_2$ in terms of $A-a'$ and of L , and an examination of the enlarged photographs of a number of bubbles shows that the ratio $\frac{L'}{A-a_b}$ is very approximately equal, in every case, to $\frac{1L}{5(A-a')}$.

Making this substitution, the viscous loss is given by

$$\begin{aligned} {}_1H_2 &= \frac{V a'}{(A-a')^2} \frac{12\mu}{\varpi} \cdot L \\ &= KVL \frac{a'}{(A-a')^2} \text{ cm.} \dots \dots (13) \end{aligned}$$

where

$$K = \frac{12\mu}{\varpi}.$$

The error involved in this assumption, in bubbles of length exceeding two diameters, is very small, and since the viscous

loss is, in general, a small fraction of the total loss, any proportional error which it may involve in the final results will be extremely small. In the tube of diameter 1.68 cm. an error of 50 per cent. in the value of K only involves an error of the order of 2 per cent. in the calculated wave-lengths, while for larger tubes the error is even less than this.

As regards the term $\frac{p_1 - p_2}{\omega}$, in the general equation of energy (6), we have

$$\frac{p_1 - p_2}{\omega} = \frac{2T}{\omega} \left(\frac{1}{r_2} - \frac{1}{r_1} \right), \dots \dots (14)$$

where r_1 and r_2 are the radii of curvature of the two ends of the bubble. Experiment shows that r_2 is large compared with r_1 , so that this term, which is always small, may be written as sensibly equal to $\frac{2T}{\omega R}$.

Making these substitutions, equation (6) finally becomes

$$\frac{v^2}{g} + KL \frac{a'}{(A - a')^2} V - L \left(1 - \frac{2T}{\omega RL} \right) = 0, \dots (15)$$

or, since $v = V \frac{a'}{A - a'}$,

$$V^2 + \frac{gKL}{a'} V - \frac{gL(A - a')^2}{a'^2} \left(1 - \frac{2T}{\omega RL} \right) = 0. \dots (16)$$

Writing $1 - \frac{2T}{\omega RL} = \alpha$, and solving, this gives

$$a' = - \frac{gL(KV + 2\alpha A)}{2(V^2 - g\alpha L)} \pm \sqrt{\left\{ \frac{gL(KV + 2\alpha A)}{2(V^2 - g\alpha L)} \right\}^2 + \frac{g\alpha LA^2}{V^2 - g\alpha L}}. \dots (17)$$

Since

$$V = 34.6 - \frac{114.0}{d^2 + 3.012} \text{ cm. sec.}$$

$$= 34.6 - \frac{89.6}{A + 2.367}, \dots \dots (18)$$

where A is in (cm.)², a' may then be obtained in terms of A . The value of v is then given by the relationship

$$v = V \frac{a'}{A - a'},$$

and on introducing this value in equation (4), or, if necessary, in (4) modified for the effect of restricted depth, the wavelength l is determined.

When examining any particular tube it is simpler to write $V = mA$, and to obtain m from the values of V given in Table I., or from formula (18). Then (17) becomes

$$\frac{a'}{A} = -\frac{gL(Km + 2\alpha)}{2(V^2 - \alpha gL)} \pm \sqrt{\left\{ \frac{gL(Km + 2\alpha)}{2(V^2 - \alpha gL)} \right\}^2 + \frac{\alpha gL}{V^2 - \alpha gL}} \quad \dots \dots (19)$$

e. g. Tube 1.680 cm. diam.: Let $L = 5$ cm.

$$V = 15.05; \quad m \text{ (calculated)} = 6.80;$$

$$\alpha = 1 - \frac{2 \times .0738}{.840 \times 5} = .9653,$$

$$Km = 12 \times .00001333 \times 6.80 = .00109.$$

On substituting these values in (19) we get $\frac{a'}{A} = .819$,

$$\therefore \frac{A}{A - a'} = \frac{1}{.181} = 5.52,$$

$$\therefore v = 15.05 \times 5.52 = 82.9 \text{ cm. sec.},$$

$$r' = .840 \times \sqrt{.819} = .750 \text{ cm.}$$

Similarly if $L = 2$ cm.; $\frac{a'}{A} = .7377$; $v = 57.2$; $R' = .720$.

„ $L = 6$ „ ; $\frac{a'}{A} = .8324$; $v = 89.9$; $R' = .766$.

„ $L = 8$ „ ; $\frac{a'}{A} = .8500$; $v = 100.2$; $R' = .775$.

In the limit when L is large, $\frac{a'}{A}$ approximates to .967, and v to 455 cm. sec. Before this velocity is attained, however, the motion breaks down and, as is evident from the appearance of the walls of the bubble, eddy formation takes place in the annulus. This point will receive notice at a later stage of the paper.

Values of v and of R' , and hence of h , the thickness of the film of water in which ripple formation takes place, have been calculated as above for the tubes of 1.680, 2.695, and 5.09 cm. diam. In every case it appears that the ratio of $h \div l$ is greater than .75, and consequently formula (4) has

been used to calculate the wave-length l . The following are the results of the calculations.

Diam. of tube (cm.) } Length of bubble L cm.	1.680.					2.695.					5.09			
	1.5	2.0	4.0	6.0	8.0	2.5	4.0	6.0	8.0	10.0	4.0	6.0	8.0	10.0
$\frac{a'}{A}$705	.738	.799	.832	.850	.667	.720	.762	.790	.808	.677	.717	.747	.767
v cm. sec.	51.0	57.2	75.0	89.9	100.2	70.4	83.6	98.6	111.2	122.0	92.5	105.7	118.0	128.2
h cm.135	.119	.0895	.0689	.0655	.248	.205	.171	.149	.136	.450	.390	.345	.315
l cm. (calculated)	.175	.139	.0810	.0564	.0453	.092	.0651	.0470	.0370	.0306	.0533	.0408	.0327	.0277
$\frac{h}{l}$77	.86	1.11	1.22	1.44	2.70	3.15	3.64	4.02	4.45	8.45	9.55	10.6	11.4

In fig. 4 these relationships between the lengths of bubble and of ripple are shown by the full-line curves, and against these are plotted the measured values of the wave-lengths.

Fig. 4.

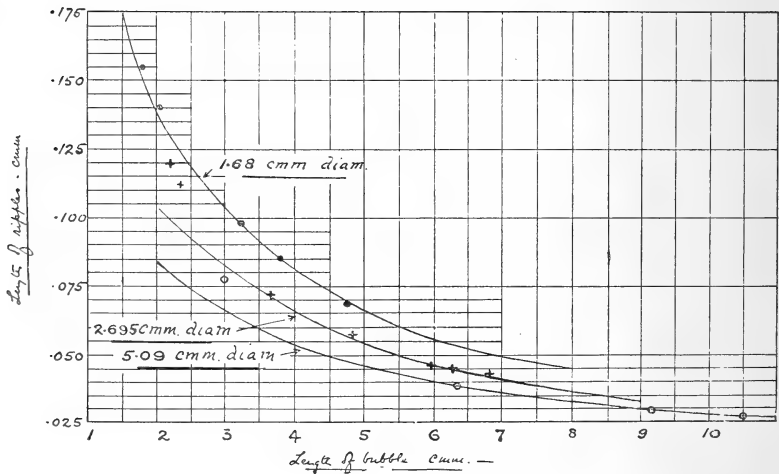

From these it appears that the agreement between measured and calculated values is very close for all the tubes so long as the length of bubble exceeds the bore of the tube. For shorter bubbles the measured values are, as would be expected, greater than those calculated from these equations.

5. *Limiting length for stability of flow past the bubbles.*—

As indicated on p. 963, for great lengths the velocity of flow past the bubble, on the assumptions outlined in this paper, becomes very great, and from general considerations one would expect this, at some definite length, to attain the critical velocity of eddy formation in the annulus. Observation shows that such is the case, and that in very long bubbles stream-line motion breaks down, as is indicated by the frosted appearance of the film, at some distance from the head of the bubble. Some difficulty was experienced in ascertaining the conditions under which this takes place, as such bubbles are too long to permit of being photographed at short range. In consequence visual observations had to be made on the moving bubble, and any estimates of length are hence liable to a fairly large percentage error. So far as could be observed, the motion is perfectly stable in the tube 0.788 cm. diam. for all bubbles of length not exceeding 15 cm. With longer bubbles, however, eddies are formed at a point about 10 cm. from the head, and this appears to be approximately true whatever the length of the bubble. In the 1.68 cm. tube the limiting length for stability of flow appears to be about 25 cm., and the motion breaks down at about 15 cm. from the head.

In neither case does there appear to be any tendency for the bubble to split up into a series of shorter bubbles, as in the case of an air-column in open water*. In the latter case the length for maximum instability is found to be 6.48 times the diameter, equivalent to approximately 5 cm. in the smaller and 10.5 cm. in the larger tube. It is, indeed, probable that the comparative thinness of the boundary film, and the fact of its contact with the walls of the tube, have the same effect as regards the tendency to lateral motions of large extent as an increase in its viscosity, and so tend to minimise the tendency to regular subdivision.

Owing to the difficulty experienced in forming and observing the motion of very long bubbles in the tubes of greater diameter than 5.09 cm., no such observations were made. It is evident, however, from the data in the table on p. 964, that the larger the tube the thicker is the film between bubble and tube for bubbles having similar ratios of length to diameter, so that the tendency to instability must be greater in a large than in a small tube.

University College, Dundee.

* Rayleigh, *ante cit.* p. 596.

LXXXV. *The Spectra of High-Frequency Discharges in Geissler Tubes.* By ROBERT W. LAWSON, M.Sc., Pemberton Fellow of the University of Durham*.

[Plates XXI. & XXII.]

IT is a well-known fact that a variety of spectra can be obtained with many elements according to their mode of electrical excitation, and hence it is highly desirable to examine their spectra as obtained by different methods. Such a procedure may greatly assist in the determination of the underlying causes for the production of one or other of the spectra of the element concerned. In the case of vacuum tubes the pressure of the gas, its temperature and purity, the current density and voltage employed, are all known to influence the character of the discharge, but in a way not clearly understood. When a condensed discharge is used, the investigator is led to ask himself whether it is the maximum value of the current during each train of oscillations, or some mean value which determines the production of a different spectrum from that of the uncondensed discharge. On the other hand, is the production of the new spectrum at all influenced by the fact that the discharge is oscillatory in character? If this last be the determining influence, then the condenser spectrum should be obtained when any type of oscillatory discharge is used.

In the present work the source of current was the Poulsen-arc high-frequency generator. This consists essentially of a magnetically deflected arc, burning in a coal-gas atmosphere, between a water-cooled anode of copper and a cathode of carbon. Across the arc terminals are placed a condenser and an inductance in series, and the resulting oscillations in this oscillatory circuit can be maintained constant over comparatively long periods. Moreover, in such a case, the oscillations are undamped, and hence give rise to a more uniform current than that obtained in the ordinary condenser spark-gap discharge, where the oscillations are strongly damped.

The occurrence of many terrestrially unknown lines in the spectra of certain celestial bodies made it still more desirable to examine gaseous spectra by the present method. In this respect, the green lines of nebulium (λ 5007) and of coronium (λ 5303) deserve special mention, as undoubtedly the type of excitation existing in the nebula and coronal halos differs from that hitherto used in the laboratory.

* Communicated by the Author.

Descriptive.

During the earlier stages of the work, ordinary glass discharge tubes were used, with electrodes of platinum and aluminium. It was found, however, that enormous heating took place in these discharge tubes, and after only a few seconds' action they collapsed, owing to softening of the glass or uneven expansion at the electrodes. Geissler tubes of the usual pattern, but with external electrodes, were then tried. Three forms of external electrode were tested, and one consisting of small cups of mercury round the bulbs was eventually decided on. The current was led to the tube by means of a platinum-tipped wire dipping into one of these cups, and the exit wire dipped into that round the other bulb. This type of external electrode does not appear to have been used hitherto, and can be specially recommended as being more generally useful than the ordinary forms, viz.: (a) Tin-foil wrappings round the bulbs, (b) Cylindrical brass cups round the bulbs, the intervening space being tightly packed with powdered graphite. The danger of piercing the tube owing to imperfect contact of electrode and glass was found to be greatly reduced by use of these external mercury cups. But even with these cups surrounding the glass bulbs, the tubes were still liable to collapse, owing to the great heating produced by the present type of discharge. Where the glass was slightly thinner than in the surrounding parts, the current appeared to pass more readily, and the consequent rapid local heating very soon resulted in holes being blown through the bulbs. After much preliminary work on various tubes, it was ultimately decided to use tubes of fused silica*. These were of the pattern shown in fig. 1. Connexion was

Fig. 1.

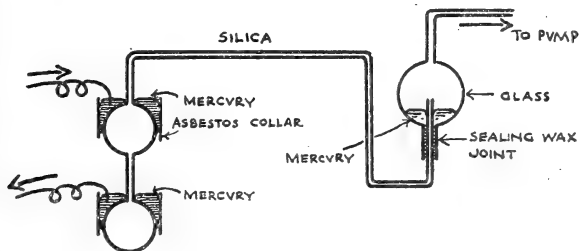

made with the rest of the glass apparatus by means of a sealing-wax joint, mercury-sealed as shown in figure. The electrodes were of the external mercury form, and consisted

* As obtainable from the Silica Syndicate, Hatton Garden, London.

of short lengths of one-inch glass tubing made to grip the tube by means of a tightly packed annulus of asbestos string, the resulting cups being filled with mercury. The apparatus was in permanent connexion with a U-tube mercury manometer, and by means of suitable stopcocks it could be connected respectively with a Toepler pump and a gas-collecting tube. This last contained phosphorus pentoxide, and the gases were allowed to stand in contact with this drying agent during several days before use.

For the photography of the spectra obtained, a Hilger fixed-arm spectrograph was used. Owing to the prism being of dense glass, the limits of spectral lines obtainable were about λ 6700 and λ 4000. By the use of Panchromatic plates, as sold by Wratten and Wainwright, the less refrangible parts of the spectrum were included on the photographs. A wave-length chart was constructed by measuring up standard lines in an iron arc spectrum, and plotting the wave-lengths of these against the reading as given by a dividing engine. For accurate measurements of spectral lines, the spectrum in question was measured up and the wave-lengths found from the chart. For purposes of identification only, it was found to be most convenient to use an iron arc plate on which the wave-lengths of the principal lines had been marked. By superposition of this plate upon the one to be examined, a tolerably accurate estimate of wave-lengths could be obtained.

For the measurement of voltage across the discharge tube a Kelvin electrostatic voltmeter was used in a manner subsequently to be figured. The discharge current was measured by passing it through a fine platinum wire, which heated a copper-constantan thermo-couple, and the resulting electromotive force was registered on a Paul single-pivot galvanometer. Another form of current-measurer used consisted of a fine copper wire, through which the current passed. This was enclosed in one bulb of a differential air thermometer, and the current measured by noting the increased pressure in the bulb due to the heating wire. Previous calibration of these ammeters by means of direct current was necessary to obtain the current-reading in amperes.

An induction coil was kept conveniently near the discharge tubes, so that the discharge as obtained by the Poulsen generator could be compared with either the condensed or the uncondensed induction-coil discharges. Direct comparison could therefore be made under the same conditions of pressure and mean current density in the discharge tube.

In addition to the measure of current, voltage, &c., of the

oscillatory discharge, the frequencies of discharge employed were also obtained, and for this purpose a portable wavemeter was used. This consisted of a variable Cossor air condenser, across the terminals of which different inductances could be attached, enabling the experimenter to tune up to different frequencies. Standardization of this portable wavemeter with the Fleming cymometer enabled curves to be drawn connecting the frequency and condenser scale reading, a graph for each tuning coil being obtained. A neon tube was usually connected across the condenser terminals of the wavemeter, and when exact tuning was attained, the neon tube glowed brightly with its characteristic orange-red glow.

Method of Producing the Discharge.

Various methods of direct and inductive coupling were employed between the generating and discharge circuits. Two of these, however, were found to be particularly suitable, and these were generally used. In the later stages of the work it was found that by an adaptation of these methods, the discharge could be safely maintained in glass tubes with internal electrodes, without breakage, which seemed inevitable in the earlier work. This was of great service, particularly owing to the fact that the ordinary condensed discharge spectrum of a gas cannot be obtained when external electrodes are used, so that one could not legitimately hope to obtain the condenser spectrum using the Poulsen discharge with external electrodes.

Fig. 2.

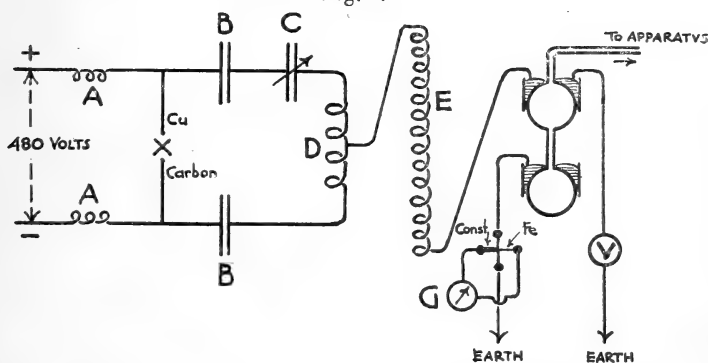

(a) This method will be most clearly understood by reference to fig. 2, which shows the general arrangement of
Phil. Mag. S. 6. Vol. 26. No. 156. Dec. 1913. 3 U

the electrical apparatus. The arc-deflecting electromagnet has been omitted from the diagram of the generator, as its omission simplifies the diagram. AA are air-cored choking coils for the purpose of preventing the oscillations from reacting on the primary supply circuit; BB are block condensers; C a variable capacity in the form of oil condensers; and D is a variable primary inductance. The Oudin coil E was of about one metre in length, and consisted of some 2100 turns of fine copper wire wrapped on glass tubing of 3.4 cm. diameter. It served to cut down the current in many of the high-energy discharges, and thus prevented undue heating in the Geissler tube. After passing through the discharge tube the current passed across the thermoelectric junction shown, and thus only the portion of the current traversing the tube was registered. V is an electrostatic voltmeter arranged as shown. With lower-frequency discharges of the order of 2×10^5 per second the energy in the oscillating circuit was of a very high order quantitatively, and it was a very easy matter to draw from the coil D an arc of two or three inches in length. With discharges of such frequency it was found possible to boil the mercury in the upper cup of the discharge tube, owing to the large current passing and the heat produced where the discharge entered the tube. For this reason the coil E was usually inserted, and found to produce more satisfactory working. With higher frequencies it could usually be dispensed with, as the energy was not then so great. The maximum frequency used was about 1.5×10^6 per second, whilst 0.22×10^6 was the lowest frequency attainable in the present experiments.

Fig. 3.

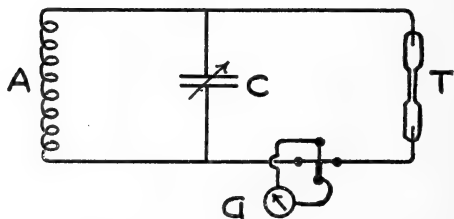

(b) The second arrangement used was simply an adaptation of the wave-meter, and will be clearly understood from fig. 3. The wave-meter inductance A consisted of a circular coil of

wire, which could be variably coupled with the inductance of the generator. The Geissler tube T was inserted across the condenser terminals, and the current was measured as hitherto described. This arrangement was found to be particularly suitable in the case of discharges with internal electrodes, owing to the ease with which the current in the discharge circuit could be adjusted, simply by altering the degree of coupling with the generator.

Character of Discharge.

Whilst it was readily possible to obtain feeble discharges similar to those obtainable using an induction coil, the majority of the discharges from the Poulsen-arc generator were of extraordinary brightness, far surpassing that obtained by the other methods available. The advantage of this lay in the fact that very short exposures were necessary using this type of discharge, and greater average constancy of the conditions of discharge was maintained for these short intervals. It should be mentioned that in the first method of producing the discharge the current through the discharge tube could be varied *ad lib.* by altering the position of the direct coupling lead on the oscillatory circuit coil D, fig. 2.

Of the gases used in this work, the hydrogen, oxygen, and nitrogen were prepared and purified by the writer. In the case of air, this was carefully freed from water vapour and carbon dioxide. The gases neon, helium, argon, and carbon dioxide were of guaranteed purity, as supplied by Hilger in tubes with aluminium electrodes.

The form of the bulb discharge was found to vary greatly according to the pressure and current in use, and as similar effects appeared with all the gases used in the external electrode tubes, these will now be described. The diagrams in fig. 4 are representative of the bulb, *a* and *c* corresponding to low current-density bulbs at the pressures indicated. It will be noticed that the shaded portion of the bulb discharge, which shows the weak spectrum of the capillary positive column, contracts towards the capillary when the pressure is reduced. At the same time the negative glow, corresponding to the cathode glow with internal electrodes, makes its appearance just below the mercury cups. When the current density through the tube is greatly increased, at the higher pressures the bulb discharge contracts laterally, as shown in

b, whilst at lower pressures it expands laterally to a small degree, but contracts towards the capillary (see *d*). Concomitant with this effect the negative glow (dotted) discharge,

Fig. 4.

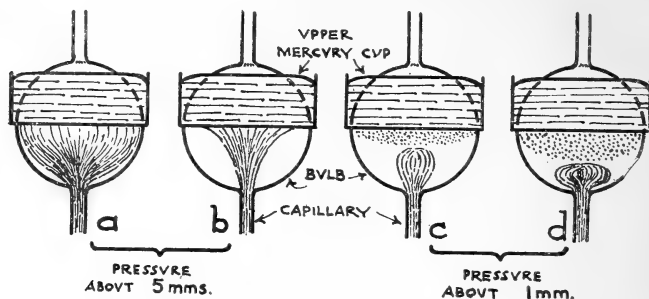

whilst not visible in *b*, extends still further down the tube in *d* than in *c*. These effects would account for results obtained with hydrogen, nitrogen, and oxygen, where it was found that increase of current in the bulb at about 1 mm. pressure, intensified the negative-glow spectrum in the bulb, and made it extend nearer towards the capillary. In addition, it was observed that the effect of reduction of pressure in the discharge tube was to produce a gradual transition of the spectrum of the bulb from pure positive column to almost pure negative glow. In this last case a slight admixture of the less refrangible parts of the spectrum of the positive column caused the lack of purity. When the pressure of the gas in the discharge tube reached a certain critical value the form and colour of the bulb discharge changed, and the bulb was filled with a glow of uniform intensity. The change appeared to be quite abrupt, and corresponded to the stage when the negative glow just filled the bulb. The effect was very striking in the case of nitrogen, for just previous to the attainment of this critical pressure the bulb was filled with a blue-violet glow characteristic of the negative glow in nitrogen, then it suddenly changed colour from the above to a bright rosy purple. For nitrogen this critical pressure was about 0.4 mm. In the case of hydrogen, the effect was by no means so marked, but, nevertheless, it was observed. The occurrence of both the primary and secondary spectra of hydrogen in the bulb and capillary rendered the colour-changes less distinct with hydrogen, and in this case the critical pressure appeared to be in the neighbourhood of 3 mm. That this value should be so different from that for nitrogen was unexpected, but repetition led to the same results in

either case. The change was also noted with oxygen, but no measurements were taken in this case.

In the Poulsen discharge with internal electrodes, the appearance of the bulbs was that of a combination of the positive and negative bulbs with the uncondensed induction-coil discharge. The positive column extended from the capillary into the bulb, and at the higher pressures used it reached to the tip of the electrodes. Surrounding each electrode was the negative glow with the Crookes dark space of normal thickness. The negative glow, however, showed a greater proportion of the spectrum of the positive column than was the case with the ordinary induction-coil discharge. This combined effect at the electrodes with high-frequency currents is doubtless connected with the alternating nature of the discharge, the electrodes being alternately positive and negative with respect to each other. The author has observed a precisely similar effect, using the induction-coil discharge. If one of the secondary terminals be left free, and the other be connected to earth through the Geissler tube, then the negative glow shows feebly round both electrodes of the discharge tube.

As examined by a rotating mirror the high-frequency Poulsen discharge in Geissler tubes appeared as an uninterrupted band of light of uniform intensity. This is what would be expected with such a type of undamped oscillatory discharge. At high speeds the separate discharges were distinctly resolvable.

Examination of Spectra.

In none of the cases examined was the frequency of the discharge found to have any influence on the spectrum obtained, this being the same at lower and higher frequencies, other conditions being maintained constant. As already mentioned, the limits of frequency used were 0.2×10^6 and 1.5×10^6 per second respectively. Moreover, in none of the cases examined was it found possible to produce the condensed discharge spectrum by means of the Poulsen high-frequency generator, no matter how the current and voltage were adjusted. That the oscillatory character of the condensed discharge is the determining factor for the production of the elementary line-spectrum of a gas is thus an untenable suggestion. It seems probable that the production of the line-spectrum of a gas by use of condenser and spark-gap is dependent on the initial value of the current in the discharge tube at each train of oscillations. If this be the case, it is possible that with very heavy steady currents, greater than

any here possible, and particularly by use of internal electrodes in silica tubes, the condenser line-spectrum of various gases may be produced. It is a noteworthy fact that with the external electrode tubes, the elementary line spectrum of a gas could not be obtained, using the induction-coil discharge from condenser and spark-gap. This was most probably due to the high resistance of the discharge tube, this preventing the ready charge and discharge of the condenser. The spectroscopic observations made on the different gases will now be treated under their respective heads.

Nitrogen.

The methods usually used for the production of spectroscopic nitrogen are somewhat unsatisfactory, owing to the fact that the evolution of gas takes place spasmodically and the action is somewhat violent. The following method* was adopted with great success. Briefly, it consists in preparing chlorine from a mixture of equal parts by weight of sodium chloride and manganese dioxide by adding a solution of eleven parts by volume of sulphuric acid in nine parts of water. The chlorine is then passed through strong ammonia solution, and nitrogen is liberated, together with hydrochloric acid and ammonium chloride. These last are removed by repeated washing of the nitrogen in air-free water, by passing over solid caustic potash, and after bubbling through concentrated sulphuric acid, the remaining nitrogen is collected over mercury. It can then be passed into the adjacent drying tube, and from thence into the discharge tube. The nitrogen thus prepared has been subject to gas analysis and found to be quite pure. Moreover, a steady stream of nitrogen could be obtained, and in the present case this was allowed to flush the collecting-tube for six hours before a sample was collected. By this means the purity of the final sample is ensured.

The independence of the spectrum of nitrogen—as excited by use of the Poulsen arc—on frequency is clearly shown on the first photograph appended (Pl. XXI.), which corresponds to a pressure of 1.5 mm., with current and frequency as indicated on the photograph. The external electrode silica tube was here used.

Variation of current density and voltage in the discharge tube with internal or external electrodes did not produce any change in the relative intensity of the nitrogen bands in

* Suggested to the writer by Dr. Paterson, Armstrong College, Newcastle.

the capillary. When the bulb discharge with the silica tube was examined the effects already noted generally, in connexion with fig. 4, were clearly illustrated. At higher pressures the intensity of the negative-band spectrum was imperceptible, whilst the positive-band spectrum showed clearly, and increased in intensity with increasing current. At lower pressures, comparable with 1 mm. of mercury, the change in the spectrum of the bulb discharge with heavy currents is shown photographically in print 2 appended (Pl. XXI.), for which the pressure was 1.5 mm. By using a long slit, and focussing the join of capillary and bulb on this, by means of an auxiliary achromatic lens, simultaneous photographs of bulb and capillary discharges were obtained. This method was frequently used. A result identical with that shown in print 2 was obtained, due to variation of pressure in the discharge tube, the current being maintained constant. At higher pressures the lower photograph represents the spectrum obtained—the negative-glow spectrum being almost entirely absent. This spectrum is shown strongly, however, in the bulb at low pressure. The evolution of positive-band spectrum at the same time becomes much enfeebled in the bulb, as shown in the upper photograph, particularly in the case of the less refrangible bands. When the pressure in the discharge tube reached the critical pressure previously alluded to, the character of the spectrum of the bulb no longer remained pure. At such low pressures the negative-glow spectrum extended into the capillary, whilst the positive-band spectrum occupied a prominent place in the bulb spectrum. This remark applies especially to the less refrangible bands in the red and orange, and it can be seen clearly in print 3*a*. No doubt the bulb owed its rosy appearance to the presence of these positive bands under such conditions of pressure. The lower photograph 3*b* is of the capillary, and it will be noticed that the usual banded capillary spectrum is not here shown alone, but it is intermixed with the negative-band spectrum. (Contrast print 1.) This change of behaviour of the discharge may be due to greater uniformity of electrical conditions in the discharge tube at lower pressures, where we would have conditions analogous to the wide extension of the Crookes dark space in an ordinary discharge tube. From analogy with the ordinary induction-coil discharge, it would appear that uniformity of electrical intensity would result in the appearance of the positive-band spectrum in the bulb.

Using the method of direct coupling, and choking the current by means of the Oudin coil, the writer was enabled

to test the discharge in nitrogen with internal electrode tubes. The spectrum was observed for the large variety of cases examined with the external electrodes, and found to be identical with those. The bulb effects, however, were different, and behaved analogously with those of the ordinary induction-coil discharge. In one instance, where the wave-meter discharge circuit was used, and the diameter of the capillary was 1 mm., the current passing through the nitrogen tube with aluminium electrodes was as high as 0.4 ampere. Now this was a greater current value than those examined when the condensed discharge from the induction coil was used, but only the mixed positive and negative band spectra resulted. It would appear that in this we have additional support to the idea that it is not the mean value of the current in the condensed discharge which causes the condenser spectrum to be emitted. Whilst the mean value of the current in the condenser discharges examined was often similar to that mentioned above, the initial value at the head of each train would greatly exceed the above value, and in this perhaps we have the reason for the difference in spectrum obtained in the two cases.

Air.

The samples experimented on were freed from the presence of carbon dioxide and water vapour by passing over caustic potash and through concentrated sulphuric acid, and then allowing the gas to stand over phosphorus pentoxide till required. The discharges in air were carefully examined, visually and photographically, when both internal and external electrodes were used. In no case were any oxygen lines discernible, the spectrum being the same as that of pure nitrogen under every circumstance. The identity of the spectra in air and nitrogen can be seen from an examination of spectrogram 4 (Pl. XXII.), which is that of a Poulsen discharge in air at 1 mm. pressure, the frequency of the discharge being 0.2×10^6 oscillations per second. The negative-glow discharge in Geissler tubes with internal electrodes failed to show any trace of the spectra of oxygen.

Hydrogen.

This was prepared by the electrolysis of an air-free solution of baryta in water. After bubbling through strong sulphuric acid the gas was collected over phosphorus pentoxide, as in the case of the other gases.

At constant frequency the series spectrum of hydrogen

was greatly enhanced relatively to the secondary or many-lined spectrum, when larger current values were used. This is a similar result to that obtained with increased currents in hydrogen when the induction-coil discharge is used. The appearance of the tube, particularly with the Poulsen discharge, is very striking. At low currents the tube has somewhat of a bluish-lavender colour, whilst at high currents it glows very strongly with a strong ruddy glow. With gradually increasing current-values the secondary spectrum appeared to increase uniformly, but the primary spectrum showed marked selectivity, the α , β , and γ lines increasing in descending order of magnitude respectively. Thus with the Poulsen high-frequency discharge we obtain results strictly compatible with those obtained by Nutting and Tugman*, using the induction coil with varying currents. The appearance of the discharge can well be judged from examination of the four spectrograms 5 *a*, 5 *b*, 5 *c*, and 5 *d* (Pl. XXII.) taken with a discharge of oscillation frequency 0.2×10^6 per second at 1 mm. pressure. *a* and *b* were arranged to have the same approximate intensity of series lines, and it will be noticed that at the lower current density the secondary spectrum is much more prominent than at the higher current density. The same result is shown in *c* and *d*, where the intensity of the secondary spectrum was maintained constant, whilst it will be noticed that the primary spectrum is much more pronounced at the higher currents. Exactly analogous effects were noted in the tube of hydrogen with internal electrodes.

At higher pressures the external electrode bulbs were rich in the secondary spectrum, but showed the primary spectrum very feebly. When the pressure fell below the critical value mentioned above, the bulbs became decidedly redder in colour, owing to an increased selective admixture of the primary spectrum. This result bears close resemblance to that obtained under similar circumstances with nitrogen.

Oxygen.

The oxygen was prepared by heating potassium permanganate in a glass tube sealed on to the apparatus. The exit tube from the permanganate tube was plugged with glass-wool to prevent escape of the reduced permanganate into the rest of the apparatus. Much trouble was experienced from the presence of water in the permanganate, presumably in occluded form. It was found that this was almost wholly removed by heating the permanganate in an oven at 110°C . for 48 hours previous to use. Any remaining moisture was

* *Astroph. Journ.* xxxi. 1910, pp. 62-75.

frozen out of the apparatus by immersing a side tube in a mixture of solid carbon dioxide and ether. A mercury-sealed tap was necessary in the case of oxygen to separate the tube from the rest of the apparatus, including the pump. This was for the purpose of avoiding contamination of the oxygen with tap-grease.

Under all the conditions of voltage, current, and gas-pressure available, the compound line-spectrum was alone obtainable at ordinary temperatures. Changes in pressure between the limits of 1 mm. and 28 mm. were found to produce no changes in relative intensity of the lines of the compound oxygen spectrum, the same current being used for comparative purposes. The diameter of the capillary of the silica tube was 1.6 mm. and the maximum value of the current used was 0.114 ampere. At the higher currents the carbon monoxide spectrum showed strongly, but the oxygen spectrum was unaffected.

With low current density discharges at low temperatures (CO_2 -ether mixture) the continuous spectrum of oxygen was obtained, but this merged into the compound line-spectrum as the current was increased.

When the discharge was examined in Geissler tubes with internal electrodes, the spectra observed were not found to differ from those obtained under similar circumstances in the silica tube.

Argon.

Argon possessing three different spectra, it is a particularly suitable gas to test under the conditions used in these experiments. The red spectrum is that usually produced by use of the uncondensed induction-coil discharge; the blue spectrum is that of the condensed discharge; whilst the white spectrum is the result of mixed conditions, and is composed of the mixed red and blue spectra with numerous modifications. Trowbridge* has shown that the use of a condenser is necessary to produce the blue spectrum with an induction coil. He attributes the production of the blue spectrum by Kayser† without the use of a condenser in the secondary, to the fact that the secondary was probably in resonance with the primary of the induction coil, in which circuit was the usual primary condenser. By removal of the primary condensers the red spectrum only was obtained. It appears then that a condenser is necessary for the production of the blue spectrum of argon, but whether large

* Trowbridge and Richards, *Phil. Mag.* xliii. 1897.

† Kayser, *Astroph. Journ.* iv. 1896.

instantaneous current or some other factor, such as the oscillatory nature of the discharge, is the primary cause or not does not appear clearly shown. It is usually considered that the red spectrum is that of low current density, whilst the blue spectrum requires higher current densities for its production. On the other hand, temperature may be an important influence, as reviewed by Sheard*, who gives a bibliography of work on the spectrum of argon. From his own experiments this author shows that a fairly complete transformation from red to blue spectrum can be obtained by use of increasing capacities in the secondary discharge circuit. It does not appear that the conclusion arrived at, viz. that current density is the determining factor, straightway follows. For with variation of the capacity we vary also the frequency of discharge, and with larger condensers the increased interval between successive discharges, as well as the damping factor of the circuit, may not be without influence. The question was returned to recently by Stead†. Using a battery of small storage cells, he endeavoured by simply altering the conditions to produce the red and blue spectra at will with direct current. All attempts in this direction, however, failed.

Now, using the Poulsen high-frequency generator, the current can be varied over wide limits simply by adjusting the closeness of coupling between the discharge and generating circuits. The same frequency is maintained throughout any series of experiments, and the effect of increased energy in the discharge circuit can be noted. In these experiments it can be assumed with moderate certainty that the current and voltage rise together, the resistance of the tube not varying greatly. This was actually found to be broadly true in several cases which were examined. The conditions are therefore different from those of Stead, who used a Wehnelt cathode. Owing to the copious supply of electrons from his heated cathode at higher voltages, the effective resistance of the discharge tube would be greatly diminished, the current rising more rapidly than the voltage.

At frequencies of 0.2×10^6 and 1.1×10^6 precisely similar results were noted due to current variation. The spectrum, originally red, gradually became mixed, and, finally, at the highest currents used, it was almost the pure blue spectrum. There was much heating in the capillary in these experiments, and it seemed possible that this was the cause of the change

* Sheard, *Phys. Rev.* xxvii. pp. 258-266 (1908).

† Stead, *Proc. Camb. Phil. Soc.* xvi. pp. 607-609.

in spectrum. It was found, however, that by instantaneously reducing the current the red spectrum was produced even in the hot tube, so that bulk temperature has little, if any, influence. This direct transition from the red to the blue spectrum is shown remarkably well in spectrograms 6 *a*, 6 *b*, & 6 *c* (Pl. XXII.), which were all taken at the same frequency, and correspond to current strengths indicated. It will be noticed that the red spectrum shows feebly even on 6 *c*. This is due to the occasional fall of the current in the discharge circuit, owing to slight unsteadiness in the arc generator. As observed visually, the transformation to blue spectrum appeared complete. The change from 6 *a* to 6 *c* is seen to be gradual, and the correspondence between 6 *c* and the blue spectrum is clear from comparison with 6 *d*, which is a photograph of the blue spectrum as obtained by using a condensed induction-coil discharge at practically the same mean current density. As mentioned above, it thus appears likely that it is the initial value of the discharge in each train rather than the mean value of the current which determines the spectrum produced. Hence, since the complete transformation from the red to the blue spectrum was obtained by use of a constant-frequency undamped discharge with increasing current values, we can but conclude that current density is the main determining influence. In the case of the condenser discharge, the maximum value of the current would greatly exceed the mean value indicated, but the effect would be to produce only more definitely the blue spectrum. It should be mentioned that the low-current red spectrum, as obtained with the Poulsen discharge, is identical in the minutest detail with that obtained with the ordinary induction-coil discharge. The fainter upper portions of the spectrograms are of the bulb of the discharge tube, and in all cases showed the red spectrum—a result adding further confirmation to the above conclusion as to the effect of current density. Close up to the electrodes both the white and blue spectra were obtained, the latter never perfectly pure.

Neon, Helium, and Carbon Dioxide.

Standard tubes of these gases were examined under the variety of cases used with other gases, but in every case the spectrum obtained was identical with that obtained when using the induction-coil discharge without condenser. Frequency-change was wholly without influence. The diameter of the capillary of the neon tube was 2 mm., and the maximum current used was 0.09 ampere; for the helium tube these

were respectively 1.3 mm. and 0.02 ampere; and for the carbon dioxide tube 8.2 mm. and about 0.03 ampere.

In conclusion, I have pleasure in acknowledging my gratitude to Professor Stroud, who has provided me with every facility necessary for the successful issue of the experiments undertaken. To Mr. H. Morris-Airey, who originally suggested to me the examination of high-frequency oscillatory discharges, I owe an expression of thanks also, for his willingness to assist in any matter of difficulty which arose during the progress of the work. For his kindness in lending me an argon tube, I owe my further thanks to Professor Bedson, of Armstrong College, Newcastle.

Armstrong College, Newcastle-on-Tyne,
July 14, 1913.

LXXXVI. *Series of Lines in the Spectrum of Neon.*

By R. Rossi.*

IT has been shown by Runge and Paschen † that the line spectrum of helium can be grouped into six series, viz., two sets of a principal with its two subordinate series.

Similar relations were looked for in the spectrum of neon by Watson ‡, who failed to find any series though he found several groups of lines repeating themselves with constant frequency difference.

On further examination the writer has found three series of lines in the neon spectrum: two series of doublets with constant frequency difference and common convergence frequency in the visible spectrum, and one series of single lines in the ultraviolet. These series lines are rather weak compared with the lines forming the constant frequency difference groups, and this probably accounts for their being overlooked by Watson.

As the lines in series are not numerous, Rydberg's formula was adopted; Kayser's, and Hicks' modifications of Ritz' formulæ were also tried and better agreement between calculated and observed values were thereby obtained, but they have the disadvantage of requiring one more constant.

The wave-lengths are taken from Watson's paper §.

* Communicated by Prof. H. F. Newall, F.R.S.

† *Astrophysical Journal*, vol. iii. p. 4 (1896).

‡ *Astrophysical Journal*, vol. xxxiii. p. 399 (1911).

§ *Proc. Roy. Soc. A.* vol. lxxxi. p. 181 (1908).

The first doublets series is represented by the formula

$$\frac{1}{\lambda} = 24271.9 - \frac{109675}{(m + .97978)^2}.$$

The observed (λ_0) and calculated (λ_c) values being :—

<i>m.</i>	λ_c	λ_0	<i>i.</i>	$\frac{1}{\lambda}$	Δ
3	Standards for calcu- lation of constants.	5820.29	5	17181.3	166.1
		5764.55	7	17347.4	
4		5080.52	6	19683.0	166.2
		5037.87	6	19849.2	
5	4715.93	4752.91	5	21039.7	167.0
		4715.50	5	21206.7	
6	4541.18	4575.27	3	21856.6	167.2
		4540.55	3	22023.8	
7	4434.69	4467.01	1	22386.3	167.3
		4433.89	2	22553.6	
8	4364.56	4395.79	0	22749.0	167.4
		4363.69	0	22916.4	
9	4315.80	4315 *	—	—	—

* Liveing and Dewar, Proc. Roy. Soc. A. vol. lxxvii. p. 467 (1900).

The second series of doublets is represented by

$$\frac{1}{\lambda} = 24273.7 - \frac{109675}{(m + .99327)^2},$$

the values being :—

<i>m.</i>	λ_c	λ_0	<i>i.</i>	$\frac{1}{\lambda}$	Δ
3	Standards used for cal- culation of constants.	5804.62	5	17227.6	168.3
		5748.47	5	17395.9	
4		5074.35	4	19707.0	167.9
		5031.48	5	19874.9	
5	4712.47	4749.74	4	21053.8	167.6
		4712.22	3	21221.4	
6	3539.02	4573.14	1	21866.8	169.7
		4537.93	4	22036.5	

These two series with a common limit at $\lambda 4119\cdot8$ resemble two subordinate series, but all efforts to find the principal which might be expected to accompany them have so far failed. It would appear that they do not correspond to any of the helium subordinate series; for though they are nearer to the red end of the spectrum, as one would expect, the approximate relation between the separation of doublets and the square of the atomic weights does not hold.

For the search of the principal series which ought eventually to accompany the series of doublets it was thought advisable to investigate the neon spectrum further to the ultraviolet than had hitherto been attempted. For this purpose a quartz "end-on" spectrum-tube filled with neon at about 4 mm. pressure was used as source of light. A copper arc was used for the comparison spectrum. The spectrograph was a concave grating of radius 1 metre, the dispersion on the plate being $16\cdot8$ Å.U. per millimetre. The following new lines were obtained, the chief impurities being hydrogen, mercury vapour, and carbon monoxide, and traces of argon and krypton.

Wave-lengths.	Intensity.
2352·0	0
2396·5	2
2464·0	1
2639·9	1
2660·0	0

The error of these wave-lengths probably lies within $\cdot 1$ Å.U.

A photograph was also taken with a jar and spark-gap in circuit, but as in the less refrangible region * no change took place in the spectrum.

As stated before, the principal series of neon could not be found, but a series of a few ultraviolet lines was isolated.

The formula is

$$\frac{1}{\lambda} = 40929\cdot 1 - \frac{109675}{(m + 1\cdot 00657)^2};$$

* E. C. C. Baly, Phil. Trans. Roy. Soc. A. vol. ccii. p. 183 (1903).

the calculated and observed values :—

$m.$	$\lambda_c.$	$\lambda_0.$	$i.$
1	7304	7445 (?)	—
2	Standards used for calculation of constants.	{ 3472·68 2932·82	6
3			2
4	2735·71	2736·19	1
5	2639·28	2639·9	1

I desire to express my thanks to Professor Rutherford, in whose laboratory the experimental part of this work was carried out, and to Mr. H. G. Lacell for his kind gift of some neon.

Trinity College, Cambridge.

October 1913.

LXXXVII. *A New Solution to an Historical Theorem in Geometry.* By JAMES W. STEWART, B.A., Assistant Mathematical Master, Ayr Academy, Ayr*.

CONCERNING the theorem of this article, a letter was published in the Philosophical Magazine for the year 1874 (p. 354). It had been sent to the Vice-Chancellor of Cambridge. The writer refers to an article which appeared in the Magazine for 1852 (p. 366), by Prof. Sylvester, who gives reasons for supposing that no proof which does not employ *reductio ad absurdum* is possible. Along with the letter, however, a direct proof is sent. It had been discovered by a Mr. Hesse as early as 1842.

In the course of her letter, the writer says the theorem appears to have been given out at Cambridge some years previous to 1852 and to have excited the attention of some of the first mathematicians in Europe. A direct solution was demanded and after a protracted discussion it was concluded that none was possible.

Besides Mr. Hesse's proof there are two other apparently direct proofs; they appear in the 'Lady's and Gentleman's Diary,' the one in the volume for 1857 (p. 58) and the other in the volume for 1860 (p. 84). In the Philosophical Magazine for 1853 (April) a hint as to a direct proof is given, but as far as the writer knows, has not been worked out. The proof given below is perhaps sufficiently interesting to deserve publication and is probably simpler than any of the three referred to. It is original and was discovered before consulting any of the periodicals mentioned.

* Communicated by the Author.

The original theorem was, "If the bisectors of the base angles of a triangle are equal, the triangle is isosceles." It follows as a corollary to the following :—

Through any point in the bisector of an angle, two, and only two equal straight lines, terminated by the arms of the angle, may be drawn and the segments into which the lines are divided at the point are equal, each to each.

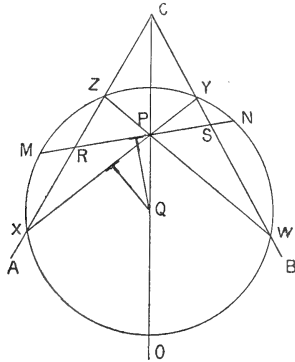

Let ACB be any angle and let CO be its bisector.

It is required to prove that through any point P in CO , two and only two equal straight lines terminated by the arms CA, CB of the angle may be drawn.

Through P draw any pair of lines XPY, WPZ in such a manner that

$$\widehat{WPC} = \widehat{XPC}.$$

It is obvious by I. 26 that

$$\triangle XPC \cong \triangle WPC \quad \therefore XP = WP,$$

likewise $\triangle YPC \cong \triangle ZPC \quad \therefore PY = PZ.$

By addition $XP + PY = WP + PZ, \text{ i. e., } XY = WZ.$

Again, since $\widehat{CXP} = \widehat{CWP} \quad (\because \triangle XPC \cong \triangle WPC),$

$$Z, X, W, Y \text{ are concyclic.}$$

Also $\triangle ZPX \cong \triangle YPW \text{ (I. 4)} \quad \therefore ZX = YW.$

These are equal chords of the $\odot ZXWY$ and are therefore equidistant from its centre;

\therefore the centre must lie in the bisector CO , for CO is the locus of points equidistant from CA and CB .

Let the perpendicular bisector of XZ (or WY) cut CO in Q , Q is the centre of $\odot ZXWY$.

Draw the circle and through P draw any chord MN cutting CA, CB in R and S respectively.

From Q drop perpendiculars on the same side of CO on to this chord and on to one of the equal chords XY, WZ.

Then XY (or WZ) > or < MN according as it is nearer to or further from Q than MN, *a fortiori* XY (or WZ) > or < RS.

Therefore, through any point in the bisector of an angle, two and only two equal straight lines, terminated by the arms of the angle, may be drawn and the segments into which the lines are divided at the point are equal, each to each.

Q.E.D.

COR. If the internal (or external) bisectors of the base angles of a triangle are equal, the triangle is isosceles.

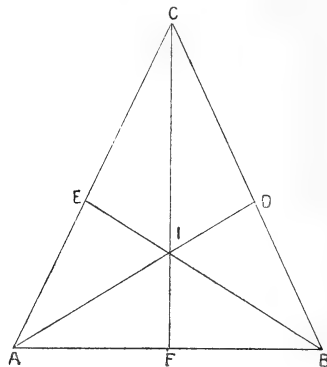

[Since the bisectors of the angles of a triangle are concurrent, in the figure the bisectors AD, BE pass through I a point on the bisector of \hat{C} .

$$\therefore IA = IB \quad (\text{by Theorem})$$

$$\therefore \hat{IBA} = \hat{IAB}$$

$$\therefore \hat{CBA} = \hat{CAB}.]$$

Those interested in the theorem are referred to 'Nouvelles Annales de Mathématiques,' 1842, pp. 138, 311; Lond., Edin., and Dublin Philosophical Magazine, 1852, p. 366; 1853, April, May and June; 1874, p. 354; Lady's and Gentleman's Diary, 1857, p. 58; 1859, p. 87; 1860, p. 84.

LXXXVIII. *Some Experiments on the Magnetic Field of two Electromagnets in Rotation.* By S. J. BARNETT, *Professor of Physics in the Ohio State University* *.

IN 1903 E. Hoppe † made some experiments with rotating magnets and iron filings which he thought conclusive in favour of the hypothesis that a magnet in rotation carries with it the lines of induction of its field. In these experiments a glass plate or a piece of paper was supported horizontal just above a vertical magnet, and iron filings were let fall upon the paper or glass while the magnet was rotated about a vertical line through its centre. Hoppe found that when the field was very intense, the iron filings became arranged in curves which were not radial, but were curved as if the rotating magnet dragged the lines of induction with it, the nearer parts ahead of the more remote. He found also that the effect was increased by surrounding the upper pole of the magnet with an iron ring at a small distance. With this arrangement and an electromagnet with a round core 3·2 cm. in diameter, driven at a speed of 10 revolutions per second, he found that the lines at the edge of the magnet deviated from radial directions by as much as 2 mm.

S. Valentiner ‡ repeated some of these experiments with a *thin* but strongly magnetized circular cylindrical magnet. When the magnet was rotated about its geometrical axis he did not get the effect observed by Hoppe; but the effect appeared when the magnet was rotated excentrically about a line parallel to its axis. Hence he concluded that Hoppe's results were due to unsymmetrical magnetization of his magnets and that his interpretation of them was incorrect.

There being available some apparatus which, though constructed primarily for another investigation §, was capable, when slightly modified, of giving information on the problem examined by Hoppe and Valentiner of a much more exact character than could be obtained by their methods, I thought it worth while, a number of years ago, to make some experiments on the subject. These experiments have recently been repeated and extended under much more favourable conditions, again with apparatus mostly designed primarily for other work.

* Communicated by the Author.

† *Phys. Zeit.* v. p. 650 (1904).

‡ *Phys. Zeit.* vi. p. 10 (1905).

§ *Phys. Rev.* xxxv. p. 323 (1912); *Science*, xxxvii. pp. 113, 560 (1913); *Phys. Zeit.* xiii. p. 803 (1912), and xiv. p. 251 (1913).

For these experiments two similar cylindrical electromagnets were mounted with their axes in the same straight line, and were so magnetized that the lines of induction stretched across from one of the adjacent poles to the other. A small elongated cylinder of iron was so mounted at the point of the field under investigation as always to follow any change (of the sort under investigation) in the direction of the intensity at the point, and a mirror attached to the magnet's support and other optical appliances made it possible to determine any change in the magnet's orientation with great precision.

In the principal series of experiments the magnets were rotated in opposite directions, and the change in the direction of the intensity produced by reversing both rotations was observed. The apparatus as arranged for these experiments will be briefly described.

The chief part of the core of each electromagnet was a rod of steel shafting 7.5 cm. in diameter. This was capped at one end with a disk of soft iron 12.3 cm. in diameter and over 2.5 cm. thick. At the other end the rod was turned down to a cylinder of 3.8 cm. diameter. The bearings were made of brass and bronze, and were 0.5 metre apart, with the coil and contact rings between them and a pulley on the other side of the bearing of smaller diameter. The bearings were firmly screwed to a heavy wooden base, itself bolted to the cement floor. The two magnets were mounted with their axes, as stated above, in the same straight line and the iron disks adjacent and 3 cm. apart.

The magnets were driven with belts by an electric motor at a speed of about 30 revolutions per second. The strength of the field between the poles was about 1200 gauss near the edge, and somewhat greater at the centre.

The small indicating magnet was mounted symmetrically at the centre of a much longer thin brass rod, the two being at right angles. The ends of the brass rod were turned to fit bearings in the caps of a narrow brass tube, which enclosed the rod and its attachments. These included the magnet, the mirror, which was plane, and a small brass vane near the bottom. The tube was mounted in a clamp of brass and wood on the laboratory wall with its axis approximately vertical, parallel to the disks, and in a plane passing through the centres of the disks. The lower part of the tube contained either castor-oil or glycerine; the brass vane, submerged in this fluid, served to damp any motion of the magnet and mirror. A hole was cut in the tube opposite

the mirror, and over the hole a converging spectacle-lens of 4 metres focal length was fastened with wax.

The optical observations were made by setting with a micrometer eyepiece upon the centre of the image, formed by the mirror and lens, of one of the terminal portions of the incandescent filament of an electric candle. The micrometer which carried the lens and cross-hairs of the eyepiece read directly to 0.01 mm. The distance from eyepiece to mirror was greater than 4 metres (see below).

Observations were made with the magnet, always half-way between the pole-faces, in three different positions: a little below the top of the poles, a little above the bottom, and at the centre of the field. In each case readings were made in sets of four; the first and fourth being made with the magnet on the right rotating clockwise as seen from its right end, the second and third with the motions reversed. The difference, *D*, obtained by subtracting the mean of the second and third from the mean of the first and fourth, was the immediate quantity sought.

By taking observations in the manner indicated it was sought to eliminate errors arising from the drift of the zero, the relative displacement of the magnets produced by the pull of the belts and the rotation, and the difference between the widths of the image when at rest and in motion.

Some of the most reliable results are given in Table I.

TABLE I.

Position of magnet.	Number of sets.	<i>D</i> .		Distance from eyepiece to mirror.
		mm.	mm.	
Above	5	-0.08	+0.01	4.1
Above	5	-0.09	+0.02	4.4
Centre	5	-0.05	+0.01	4.4
Below	5	+0.11	+0.04	4.4
Above	5	-0.04	+0.03	4.4
Below	5	+0.07	+0.02	4.4

The observations in the first four lines were obtained consecutively, as were those in the last two. The + sign indicates a twist of the lines in a clockwise direction as seen from above. The quantity following the ± is the average absolute departure of the sets in each group from the mean.

The results obtained with the magnet in the upper and lower positions would at first sight *appear* to indicate a very slight twist of the lines of induction in the direction to be expected if any entrainment of the lines of induction were actually to occur. Many other observations, similar to those given above, were obtained with the magnet in the upper and lower positions, and the results were always consistent with those given here, except that one group of 5 sets with magnet *above* gave a *positive* result ($D = +0.03 \text{ mm.} \pm 0.02 \text{ mm.}$). These observations, however, were obtained under unsatisfactory conditions. Nevertheless, in view of the large discrepancies and the systematic errors possible, the only result of which one can be confident is that the change of direction of a line near the edge of the uniform part of the field when the magnets are brought from rest to full speed is not greater than a very minute quantity (the mean from the above table is about $1''$ of arc).

In the hope of obtaining still more accurate results, the electromagnets were mounted in new bearings, fitting as closely as practicable; the bearings were bolted directly to the cement floor, the wooden bases being removed; and the optical arrangement was improved by substituting for the old mirror a new and more accurately ground one by Petiudidier, and by increasing the distance from eyepiece to mirror to 5.4 metres. This distance was kept constant throughout the rest of the work.

The results were of the same character as those obtained before. Thus 5 sets with the magnet in the upper position gave $D = -0.09 \text{ mm.} \pm 0.02 \text{ mm.}$, and 5 sets with the magnet in the lower position gave $D = +0.16 \text{ mm.} \pm 0.08 \text{ mm.}$

Mrs. Barnett, to whom I am indebted for assistance throughout the observations described here, having suggested that the distortion of the lines, if any occurred, might be a minimum over the central plane, each line having there a point of inflexion, additional observations were made as close as practicable to one of the pole-faces, but without changing the result. The pole distance of 3 cm., however, was too small to permit of any great shift of the magnet. By boring partially through and remounting the iron disks, the pole distance was therefore increased to 7 cm.; and observations were made with the indicating magnet in three positions, all corresponding in altitude to the upper position of the earlier work, but one close to the left pole, one in the middle as before, and one close to the right pole. The increase of pole distance diminished the intensity to about 800 gausses in the

central position, and to about 700 gauss in the others. Observations were made somewhat differently from those given above, the motions of the electromagnets not being reversed and the pointings being made with the magnets alternately in slow motion and in rapid motion.

The mean values of the deviations, corresponding to $\frac{1}{2}D$ in the experiments described above, were $+0.01$ mm., -0.02 mm., and -0.01 mm. for the three positions, with a mean error between 0.01 mm. and 0.02 mm.

Finally, it was thought worth while to see if any appreciable change in the trend of a line of induction occurred when the electromagnets were both set into rotation in the same direction with the same speed as before—slight as was the probability of obtaining a positive result. For this purpose the indicating magnet was placed outside the region between the poles, though near to one of them, and in such a position that its axis (and the lines of induction through it) made a considerable angle (about 35°) with the axis of the field, and the rod supporting the magnet was placed approximately perpendicular to the plane containing the axis of the field and the lines of induction passing through the magnet. Observations made like those just described gave a mean deviation, corresponding to $\frac{1}{2}D$ in the earlier work, of $+0.03$ mm., with a mean error of 0.04 mm.; indicating therefore that no appreciable bulging out of the lines was produced by the rotation.

For the construction of most of the special apparatus used in the experiments described here, I am indebted to Mr. Arthur Freund, mechanician in the physical laboratory.

The Ohio State University,
July 9, 1913.

LXXXIX. *The Recombination of Ions made by α Rays.*

By H. OGDEN, *Research Scholar in the University of Leeds* *.

BRAGG & KLEEMAN observed in 1905 that the field required to obtain the full ionization current in a gas in which a given number of ions were being produced each second was always very much greater if the ions were produced by α rays than if they were produced by β rays. They attributed this difference to "Initial Recombination." They supposed that when ions were formed by α rays the separation between the charges was less complete than when they were formed by β rays, so that there was a marked tendency for

* Communicated by Prof. W. H. Bragg, F.R.S.

the pair of ions to recombine before they could be separated by the field.

The matter has been further studied by Langevin, Moulin, and others, and attempts have been made to dispense with any special hypothesis concerning the recombination of ions produced by α rays by attributing the difference in the field required to produce saturation entirely to the difference in the initial distribution of the ions. Ionization by α rays is "columnar"; the ions are not distributed uniformly through the gas but concentrated along the path of the rays. The effective intensity of the ionization determining the amount of recombination is much greater than the average intensity. The difference between the effective and the average intensities of ionization will be much less if the field acts perpendicular to the column of ions, and tends to destroy the column by separating the opposite charges, than if it acts parallel to the column. The view that the magnitude of the saturation-field in the case of α rays could be explained on this hypothesis of columnar ionization received support when Moulin* found that the saturation-field was less when it acted perpendicular than when it acted parallel to the path of the rays.

However, this hypothesis of columnar ionization does not seem capable of explaining the whole matter. Wheelock† concludes that the saturation-field parallel to the rays is greater than that predicted by theory. Moreover the theory does not seem capable of explaining the very great difference observed by Bragg ('Studies in Radioactivity,' vii.) in the degree to which Initial Recombination is displayed in different gases. It appeared, therefore, that a further investigation of the problem was desirable, especially in the direction of observations with different gases.

The apparatus used was the same as that used by Bragg‡ in his experiments on the ranges of alpha particles from radium and its products, and was only altered in a few minor details to meet the climatic conditions which in Leeds differ from those in Australia, where the apparatus was first used. Only a brief description is therefore necessary. A layer of radium R (fig. 1) was used as the source of α rays. The gas of which the ionization was measured was contained between an insulated brass plate, Q, connected through a key-box to a Dolezalek electrometer, and a sheet of gauze, *gg*, parallel to the plate and distant 2.1 mm. from it, This gauze could

* Moulin, *Comptes Rendus*, cxlviii. p. 1757 (1909).

† Wheelock, *Am. J. Sci.* [4] xxx. p. 233 (1910).

‡ *Phil. Mag.* x. p. 318 (1905).

be maintained at any desired potential. To prevent diffusion of the ions, another sheet of gauze, g_1 , which was earthed was placed parallel to the high potential gauze and on the side remote from the plate. The α rays were canalised by a set

Fig. 1.

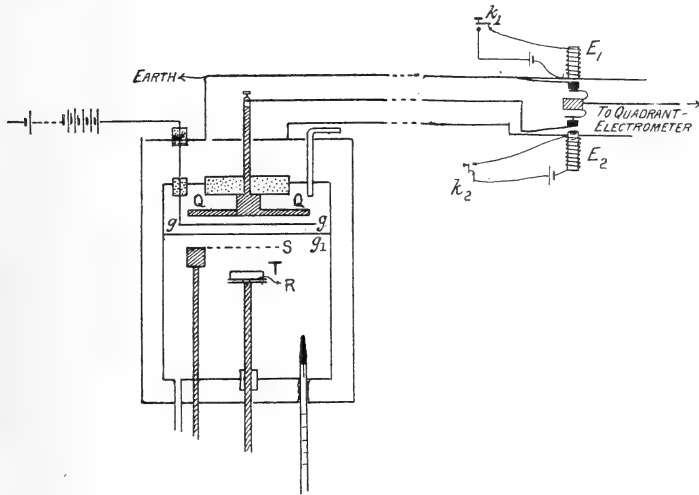

of copper tubes, T, 1 cm. long by 1 mm. diameter placed over the radium. A screen, S, could be brought over the radium to cut off these α rays, so that the ionization due to the β and γ rays might be measured. The whole of this apparatus was enclosed in a nearly gas-tight vessel, which in turn was enclosed in an outer vessel. Both were filled with the gas under examination, the outer vessel serving to prevent diffusion of air into the inner.

The ionization current was measured by the method used by Bragg. On the tick of a clock the key k_1 was pressed, which operated an electromagnet E_1 and so disconnected the electrometer and plate Q from earth. After 20 ticks of the clock (10 secs.) or other convenient interval a key k_2 was pressed, which disconnected the plate from the electrometer by the agency of another electromagnet, E_2 . The mean of the two ends of the first swing of the needle was taken to be proportional to the current. In an experiment on any pure gas, the chamber was first exhausted in order to get rid of any emanation which chanced to have escaped from the radium. The chamber was then filled slowly with dry air

and afterwards re-exhausted. Then the experimental gas was allowed partly to fill the outer chamber, which therefore contained the impure washings of the small connecting pipes. Then the inner chamber was filled, and, when the nature of the gas permitted it, was re-exhausted and filled again. All the gases were dried where possible by passing over long tubes of P_2O_5 after bubbling through concentrated H_2SO_4 . Ammonia was dried by quick-lime. Potentials from 0 to 640 volts were applied to the high potential plate and the ionization current measured :—

- (a) When the radium was covered. (The β , γ ray effect.)
- (b) When the radium was uncovered.

The difference between the two gave the effect of the α rays alone. The following gases were investigated :—air, oxygen, carbon dioxide, carbon monoxide, hydrogen, sulphur dioxide, methane, and ammonia. Some of the results obtained are given on figs. 2 & 2 A. The abscissæ give the P.D. in volts, the ordinates the corresponding currents expressed as fractions of the saturation current.

Fig. 2.

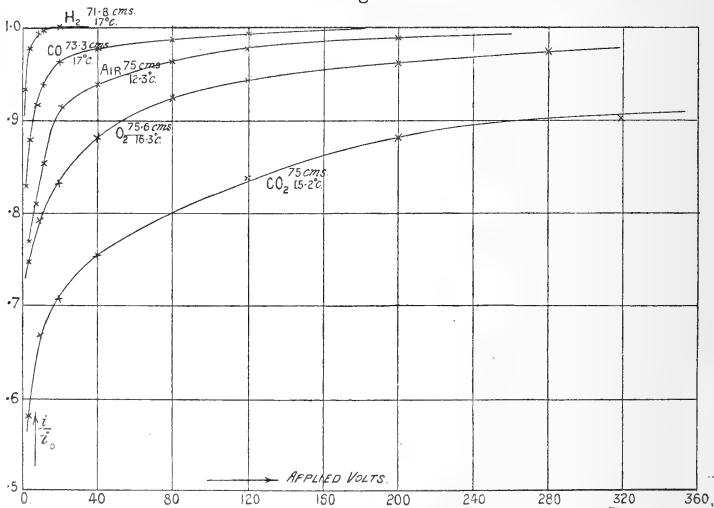

On the basis of the columnar hypothesis Wheelock has deduced the following relationship between i , the current through the gas, and X , the electric field acting on it :—

$$i = c_1 X \log_e \left(1 + \frac{c_2}{X} \right).$$

c_1 and c_2 are functions of the following constants :

- N , the number of pairs of ions generated by one
 α particle in the chamber ;
 a , the radius of a column ;
 b , the depth of the chamber ;
 k , the mobility of the ion.

Fig. 2 A.

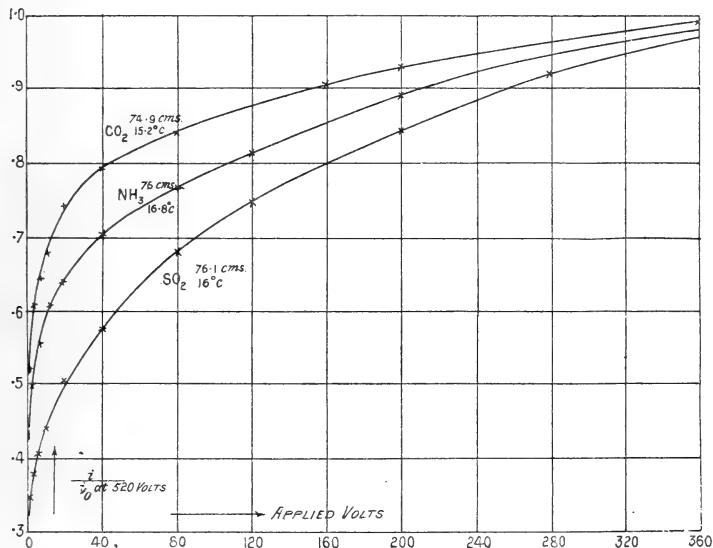

In calculating the relationship the effects of the diffusion of the ions are neglected. Diffusion must tend to decrease the field necessary to obtain saturation by causing a diminution in the density of ionization, and so decreasing recombination. Nevertheless, Wheelock found more recombination than was indicated by his formula ; if the constants c_1 and c_2 were chosen so as to make the part of the curve corresponding to small voltages coincide with the theoretical curve, the part corresponding to high voltages was always below the theoretical curve. [Wheelock, Am. J. Sci. 1910, p. 233.] In all the gases except hydrogen and CO , saturation is more difficult to obtain than can be accounted for by that formula. But, in the case of hydrogen and CO , gases which show least "initial recombination," the experimental results can be fitted to the theoretical curve with some accuracy. The amount of agreement attained depends on what part of the curve is chosen to determine the constants

c_1 and c_2 . Since the formula neglects diffusion, it will be best to determine these constants from that part which is least affected by diffusion, that is, from the part corresponding to high voltages. When c_1 and c_2 are determined from this part of the curve, the agreement between the theoretical and experimental values is good in the case of the gases mentioned, as is shown by the following table:—

Carbon monoxide, $14^{\circ}2$ C., 29.5 cm. Hg pressure.

Theoretical curve, $i = 170.8 \text{ V} \log_{10} \left(1 + \frac{1.66}{\text{V}} \right)$.

Applied volts.	α ray current in arbitrary units.	Calculated current.
{ 120 volts	116.4	116.4
{ 8	112.5	112.5
0	0	0
2	106.6	90.5
4	110.5	104
20	114.8	114
40	115.8	115.8
360	116.5	116.5

It will be noticed that the calculated values are never higher in this case than the observed, and that for the lower voltages they fall below the observed. Such a deviation is to be expected, since with the lower voltages the time for gathering the ions is comparatively long and diffusion, always operative, here manifests its maximum effect in diminishing the density of ions within the column. However, no agreement could be found for curves for CO_4 , CO_2 , SO_2 , &c., the ions of which seem to show an abnormal tendency to recombine.

A second test of the applicability of Wheelock's formula can be made. The formula can be put in the form

$$y = \frac{i}{i_0} = \frac{X}{c_2} \log_e \left(1 + \frac{c_2}{X} \right), \text{ since } c_1 c_2 = i_0 \text{ the saturation current,}$$

which is the same as Langevin's equation

$$y = \frac{1}{x} \log_e (1 + x).$$

Accordingly $\frac{i}{i_0}$ should be a function of $\frac{c_2}{X}$ only, where c_2

depends on the nature of the gas, and hence the saturation curves of two gases, characterized by different values of c_2 , ought to be reduced to the same form by orthogonal strain parallel to the axis of V , that is by altering the abscissæ in a given ratio while the ordinates are left unchanged. An attempt has been made to reduce all the curves of fig. 2 to the same form by such straining, but coincidence of the curves representing different gases cannot be obtained by such means. Some experiments were made with CO_2 at different pressures, but it was found that even when the same gas was used at different pressures, the saturation curves could not be brought into coincidence by straining. The ratio

$$\left(\frac{V_1}{V_2}\right)^{\frac{i}{i_0}} = \text{constant}$$

was not found to be approximately constant, as is evident from inspection of fig. 3. This test was also applied to

Fig. 3.

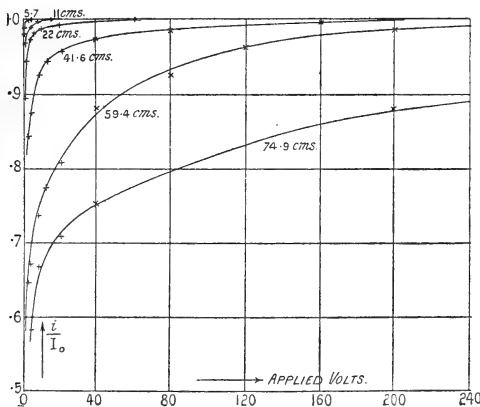

curves for hydrogen at different pressures, and in this case the values

$$\left(\frac{V_1}{V_2}\right)^{\frac{i}{i_0}} = \text{constant}$$

were found to be approximately constant, as is shown by the examples on fig. 4.

But the most convincing evidence of the inapplicability of a simple hypothesis of columnar ionization is afforded by

the comparison of the saturation curves for oxygen, carbon monoxide, and ammonia. According to any such hypothesis the form of the saturation curve with a given apparatus (the

Fig. 4.

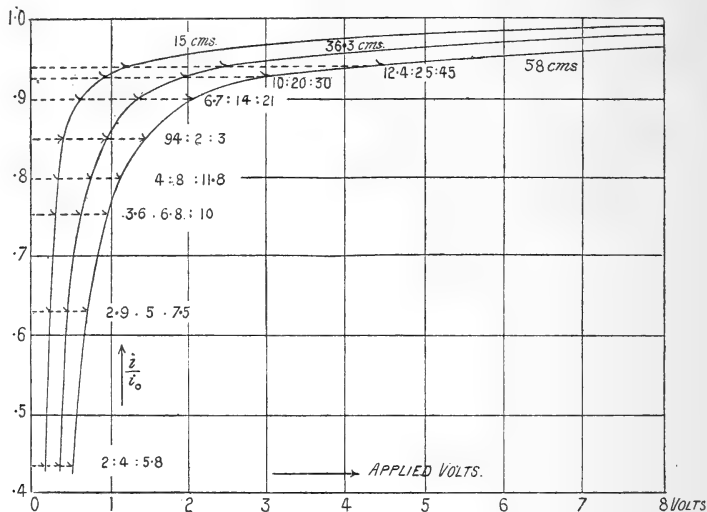

effect depending of course on the dimensions of the chamber) must be determined wholly by the constants mentioned on page 995. These constants are given in the following table :—

Property.	Constant of Equation dependent on property.	Oxygen.	Carbon monoxide.	Ammonia.	
Density	32	28	17	
Stopping-power	} N, the number of pairs of ions made in the chamber by one α particle.	10.6 S	98 S	90 S	
Total ionization		11.0 S	101.5 S	90 S	
Pressure.....		75.6 cm.	73.3 cm.	76 cm.	
Temperature.....		16° 3 C,	17° C.	16° 8 C.	
Mean mobility	k	1.58 L	1.12 L	.78 L	
Coeff. of diffusion with respect to H ₂722 L	.642 L		
Molecular diameter deduced from viscosity.	} Diameter of α ray track.	3.36×10^{-8} cm.	3.5×10^{-8}	} L	
Molecular velocity		4.61×10^4 cm./sec.	4.93		6.28
Mean Free Path		9.95	9.27		6.95

S='Studies in Radioactivity.' L=Laby & Kaye's Tables.

It will be seen that all of the constants are very nearly the same in oxygen and carbon monoxide, and yet a glance at fig. 2 will show how completely different are their saturation-curves. Thus, at 120 volts 1 per cent. of the carbon monoxide ions, 7 per cent. of the oxygen ions, whilst more than 19 per cent. of the ammonia ions, recombine. It is clear that some factor not considered by Wheelock's theory is of great importance in determining the form of the curves. Some further experiments which have been performed seem to indicate the nature of this constant.

A large quantity of carbon monoxide was prepared and was kept in a water-sealed reservoir. On testing this gas some weeks afterwards it was found to show a greater readiness to recombine than the freshly though similarly prepared specimen.

Thus:—

Volts applied across chamber.	$\frac{i}{i_0}$ Freshly prepared. 73.3 cm. 16° C.	$\frac{i}{i_0}$ Old specimen. 76.1 cm. 16° C.
4 volts	.878	.792
12	.947	.87
20	.952	.91
40	.97	.95
80	.988	.979

The difference was very marked and could not be attributed to impurities in the old gas (H_2O excepted). The experiments showing this difference were repeated many times. This result suggested investigation of the effect of degree of dryness of the gas, and hence a series of experiments on air dried by various reagents was made. In these experiments, as in other experiments where the gas liberates the emanation from the radium, the latter was enclosed in a closed box with mica or waxed tissue-paper as lid. These lids were air-tight, transparent to the long-range α rays, and were also able to withstand considerable differences of pressure. Air, bubbled through water, could be used with this precaution. It was found that in damp air the ions recombined more easily than in dry air, but the difference was not so great as in the case of carbon monoxide.

V=Applied volts.	$\frac{i}{i_0}$ Dry air (H_2SO_4 & P_2O_5).	$\frac{i}{i_0}$ Moist air (water).
8	.856	.84
20	.92	.91
40	.943	.93
80	.97	.951

Now it is known that the effect of water-vapour on the ions of a gas is to decrease their mobility, and hence these observations suggest that an explanation of the phenomenon of "initial recombination" may possibly be found in the presence of a small proportion of ions of very small mobility in the gases which display it to a marked degree. It is easy to see that the presence of such ions will tend to increase recombination and so make saturation more difficult. For if a column of positive ions is flowing through a similar column of negative ions, recombination ceases when the columns get clear of each other. If the ions are all of the same mobility this happens somewhere near the central plane of the chamber. But if there is present an ion of one-tenth the mobility of the ordinary ion, it will take ten times as long to cross the chamber, and hence will be in danger of recombination for almost twice as long a time. During half of this time recombination is very likely to occur, since the ion will be the only one of its sign in a dense column of opposite sign. And again, such an ion, being larger than the ordinary ion, would make more collisions.

According to this hypothesis the extent to which a gas shows "initial recombination" should increase with the extent to which it forms heavy ions of low mobility. Now, since the formation of such ions is likely to be due to attractions between the molecules, it is likely to be more frequent the nearer the gas is to its boiling-point. If, then, observations are made all under similar conditions as regards apparatus, temperature, and pressure, a gas which has the higher boiling-point should always show more "initial recombination." In the following table several gases are tabulated in the order of the degree in which they show "initial recombination"; hydrogen shows the phenomenon least, sulphur dioxide most. In the second column the boiling-points are given; it will be observed that, in accordance with the hypothesis, they increase regularly throughout the table. In the third column the solubilities in water are given, for it was thought that the formation of heavy ions might conceivably be dependent on this property to some extent. It will be observed that in the only case (ammonia) in which the order of solubility is different from that of boiling-point, "initial recombination" appears to be determined rather by the latter than by the former. The observations refer to dry gases; solubility might be of greater importance if the gases were moist.

Gas.	Boiling-point.	Solubility in water.
Hydrogen	-253° C.	19 parts in 1000.
Carbon monoxide	-190	25
Oxygen	-183	34
Methane	-164	—
Carbon dioxide.....	- 65	1019
Ammonia	- 33.5	802,000
Sulphur dioxide	- 10	56,600

Summary.

In the foregoing paragraphs an attempt has been made to show the shortcomings of an unamplified columnar theory in explaining all the phenomena of "Initial Recombination." The arguments are based on the failure of mathematical deductions of the theory, whether tested directly or indirectly, to predict experimental results ; and also on the great diversity shown by various gases with respect to this phenomenon. Thus ammonia, a light gas, should theoretically show little recombination, but it is found to show "initial recombination" in a very marked degree. Moisture was found to enhance recombination, which is attributed to the decrease in mobility of the ions due to the presence of moisture. The suggested reason for the deviation from the exact laws is the presence of a small percentage of ions of small mobility in the gases. This receives support from the fact that the nearer the temperature of a gas is to its boiling-point, the more does the gas exhibit initial recombination.

My thanks are due to Professor Bragg and Dr. Campbell for invaluable assistance and encouragement during the time in which the foregoing work was in progress.

XC. On the Stability of the Laminar Motion of an Inviscid Fluid. By Lord RAYLEIGH, O.M., F.R.S.*

THE equations of motion of an inviscid fluid are satisfied by a motion such that U , the velocity parallel to x , is an arbitrary function of y only, while the other component velocities V and W vanish. The motion may be supposed to be limited by two fixed plane walls for each of which y has a constant value. In order to investigate the stability

* Communicated by the Author.

of the motion, we superpose upon it a two-dimensional disturbance u, v , where u and v are regarded as small. If the fluid is incompressible,

$$\frac{du}{dx} + \frac{dv}{dy} = 0; \quad \dots \dots \dots (1)$$

and if the squares and products of small quantities are neglected, the hydrodynamical equations give *

$$\left(\frac{d}{dt} + U \frac{d}{dx}\right) \left(\frac{du}{dy} - \frac{dv}{dx}\right) + \frac{d^2U}{dy^2} v = 0. \dots (2)$$

From (1) and (2), if we assume that as functions of t and x , u, v are proportional to $e^{i(ut+kx)}$, where k is real and n may be real or complex,

$$\left(\frac{n}{k} + U\right) \left(\frac{d^2v}{dy^2} - k^2v\right) - \frac{d^2U}{dy^2} v = 0. \dots (3)$$

In the paper quoted it was shown that under certain conditions n could not be complex; and it may be convenient to repeat the argument. Let

$$n/k = p + iq, \quad v = \alpha + i\beta,$$

where p, q, α, β are real. Substituting in (3) and equating separately to zero the real and imaginary parts, we get

$$\begin{aligned} \frac{d^2\alpha}{dy^2} &= k^2\alpha + \frac{d^2U}{dy^2} \frac{(p+U)\alpha + q\beta}{(p+U)^2 + q^2}, \\ \frac{d^2\beta}{dy^2} &= k^2\beta + \frac{d^2U}{dy^2} \frac{-q\alpha + (p+U)\beta}{(p+U)^2 + q^2}; \end{aligned}$$

whence if we multiply the first by β and the second by α and subtract,

$$\frac{d}{dy} \left(\beta \frac{d\alpha}{dy} - \alpha \frac{d\beta}{dy} \right) = \frac{d^2U}{dy^2} \frac{q(\alpha^2 + \beta^2)}{(p+U)^2 + q^2}. \dots (4)$$

At the limits, corresponding to finite or infinite values of y , we suppose that v , and therefore both α and β , vanish. Hence when (4) is integrated with respect to y between these limits, the left-hand member vanishes and we infer that q also must vanish unless d^2U/dy^2 changes sign. Thus in the motion between walls if the velocity curve, in which U is ordinate and y abscissa, be of one curvature throughout, n must be wholly real; otherwise, so far as this argument

* Proceedings of London Mathematical Society, vol. xi. p. 57 (1880); Scientific Papers, i. p. 485. Also Lamb's 'Hydrodynamics,' § 345.

shows, n may be complex and the disturbance exponentially unstable.

Two special cases at once suggest themselves. If the motion be that which is possible to a viscous fluid moving steadily between two fixed walls under external pressure or impressed force, so that for example $U = y^2 - b^2$, d^2U/dy^2 is a finite constant, and complex values of n are clearly excluded. In the case of a simple shearing motion, exemplified by $U = y$, $d^2U/dy^2 = 0$, and no inference can be drawn from (4). But referring back to (3), we see that in this case if n be complex,

$$\frac{d^2v}{dy^2} - k^2v = 0 \dots \dots \dots (5)$$

would have to be satisfied over the whole range between the limits where $v = 0$. Since such satisfaction is not possible, we infer that here too a complex n is excluded.

It may appear at first sight as if real, as well as complex, values of n were excluded by this argument. But if n be such that $n/k + U$ vanishes anywhere within the range, (5) need not there be satisfied. In other words, the arbitrary constants which enter into the solution of (5) may there change values, subject only to the condition of making v continuous. The terminal conditions can then be satisfied. Thus any value of $-n/k$ is admissible which coincides with a value of U to be found within the range. But other real values of n are excluded.

Let us now examine how far the above argument applies to real values of n , when d^2U/dy^2 in (3) does not vanish throughout. It is easy to recognize that here also any value of $-kU$ is admissible, and for the same reason as before, viz., that when $n + kU = 0$, dv/dy may be discontinuous. Suppose, for example, that there is but one place where $n + kU = 0$. We may start from either wall with $v = 0$ and with an arbitrary value of dv/dy and gradually build up the solutions inwards so as to satisfy (3)*. The process is to be continued on both sides until we come to the place where $n + kU = 0$. The two values there found for v and for dv/dy will presumably disagree. But by suitable choice of the relative initial values of dv/dy , v may be made continuous, and (as has been said) a discontinuity in dv/dy does not interfere with the satisfaction of (3). If there are other places where U has the same

* Graphically, the equation directs us with what curvature to proceed at any point already reached.

value, dv/dy may there be either continuous or discontinuous. Even when there is but one place where $n+kU=0$ with the proposed value of n , it may happen that dv/dy is there continuous.

The argument above employed is not interfered with even though U is such that dU/dy is here and there discontinuous, so as to make d^2U/dy^2 infinite. At any such place the necessary condition is obtained by integrating (3) across the discontinuity. As was shown in my former paper (*loc. cit.*), it is

$$\left(\frac{n}{k} + U\right) \cdot \Delta\left(\frac{dv}{dy}\right) - \Delta\left(\frac{dU}{dy}\right) \cdot v = 0, \dots (6)$$

Δ being the symbol of finite differences; and by (6) the corresponding sudden change in dv/dy is determined.

It appears then that any value of $-kU$ is a possible value of n . Are other real values admissible? If so, $n+kU$ is of one sign throughout. It is easy to see that if d^2U/dy^2 has throughout the same sign as $n+kU$, no solution is possible. I propose to prove that no solution is possible in any case if $n+kU$, being real, is of one sign throughout.

If U' be written for $U+n/k$, our equation (3) takes the form

$$U' \frac{d^2v}{dy^2} - v \frac{d^2U'}{dy^2} = k^2 U' v, \dots (7)$$

or on integration with respect to y ,

$$U' \frac{dv}{dy} - v \frac{dU'}{dy} = K + k^2 \int_0^y U' v dy, \dots (8)$$

where K is an arbitrary constant. Assume $v=U'v'$; then

$$\frac{dv'}{dy} = \frac{K}{U'^2} + \frac{k^2}{U'^2} \int_0^y v' U'^2 dy; \dots (9)$$

whence, on integration and replacement of v ,

$$v = HU' + KU' \int_0^y \frac{dy}{U'^2} + k^2 U' \int_0^y \frac{dy}{U'^2} \int_0^y U' v' dy, \dots (10)$$

H denoting a second arbitrary constant.

In (10) we may suppose y measured from the first wall, where $v=0$. Hence, unless U' vanish with y , $H=0$. Also from (8) when $y=0$,

$$\left(U' \frac{dv}{dy}\right)_0 = K. \dots (11)$$

Let us now trace the course of v as a function of y , starting from the wall where $y=0, v=0$; and let us suppose first that U' is everywhere positive. By (11) K has the same sign as $(dv/dy)_0$, that is the same sign as the early values of v . Whether this sign be positive or negative, v as determined by (10) cannot again come to zero. If, for example, the initial values of v are positive, both (remaining) terms in (10) necessarily continue positive; while if v begins by being negative, it must remain finitely negative. Similarly, if U' be everywhere negative, so that K has the opposite sign to that of the early values of v , it follows that v cannot again come to zero. No solution can be found unless U' somewhere vanishes, that is unless n coincides with some value of $-kU$.

In the above argument U' , and therefore also n , is supposed to be real, but the formula (10) itself applies whether n be real or complex. It is of special value when k is very small, that is when the wave-length along x of the disturbance is very great; for it then gives v explicitly in the form

$$v = K(U + n/k) \int_0^y \frac{dy}{(U + n/k)^2} \dots (12)$$

When k is small, but not so small as to justify (12), a second approximation might be found by substituting from (12) in the last term of (10).

If we suppose in (12) that the second wall is situated at $y=l$, n is determined by

$$\int_0^l \frac{dy}{(U + n/k)^2} = 0. \dots (13)$$

The integrals (12), (13) must not be taken through a place where $U + n/k = 0$, as appears from (8). We have already seen that any value of n for which this can occur is admissible. But (13) shows that no other real value of n is admissible; and it serves to determine any complex values of n .

In (13) suppose (as before) that $n/k = p + iq$; then separating the real and imaginary parts, we get

$$\int_0^l \frac{(p+U)^2 - q^2}{\{(p+U)^2 + q^2\}^2} dy = 0, \quad \int_0^l \frac{q(p+U) dy}{\{(p+U)^2 + q^2\}^2} = 0, \quad (14)$$

from the second of which we may infer that if q be finite, $p+U$ must change sign, as we have already seen that it

must do when $q=0$. In every case then, when k is small, the *real part* of n must equal some value of $-kU$ *.

It may be of interest to show the application of (13) to a case formerly treated† in which the velocity-curve is made up of straight portions and is anti-symmetrical with respect to the point lying midway between the two walls, now taken as origin of y . Thus on the positive side

$$\text{from } y=0 \text{ to } y=\frac{1}{2}b', \quad U = \frac{Vy}{\frac{1}{2}b'};$$

$$\text{from } y=\frac{1}{2}b' \text{ to } y=\frac{1}{2}b'+b, \quad U = \frac{Vy}{\frac{1}{2}b'} + \mu V(y - \frac{1}{2}b');$$

while on the negative side U takes symmetrically the opposite values. Then if we write $n/kV = n'$, (13) becomes

$$0 = \int_0^{\frac{1}{2}b'} \frac{dy}{(2y/b + n')^2} + \int_{\frac{1}{2}b'}^{\frac{1}{2}b'+b} \frac{dy}{\{2y/b + \mu(y - \frac{1}{2}b') + n'\}^2}$$

+ same with n' reversed.

Effecting the integrations, we find after reduction

$$n'^2 = \frac{n^2}{k^2 V^2} = \frac{2b + b' + 2\mu b(b + b') + \mu^2 b^2 b'}{2b + b'}, \quad (15)$$

in agreement with equation (23) of the paper referred to when k is there made small. Here n , if imaginary at all, is a pure imaginary, and it is imaginary only when μ lies between $-1/b$ and $-1/b - 2/b'$. The regular motion is then exponentially unstable.

In the only unstable cases hitherto investigated the velocity-curve is made up of straight portions meeting at finite angles, and it may perhaps be thought that the instability has its origin in this discontinuity. The method now under discussion disposes of any doubt. For obviously in (13) it can make no important difference whether dU/dy is discontinuous or not. If a motion is definitely unstable in the former case, it cannot become stable merely by easing off the finite angles in the velocity-curve. There exist, therefore, exponentially unstable motions in which both U and

* By the method of a former paper "On the question of the Stability of the Flow of Fluids" (Phil. Mag. vol. xxxiv. p. 59, 1892; Scientific Papers, iii. p. 579) the conclusion that $p+U$ must change sign may be extended to the problem of the simple shearing motion between two parallel walls of a *viscous* fluid, and this whatever may be the value of k .

† Proc. Lond. Math. Soc. vol. xix. p. 67 (1887); Scientific Papers, iii. p. 20, figs. (3), (4), (5).

dU/dy are continuous. And it is further evident that any proposed velocity-curve may be replaced approximately by straight lines as in my former papers.

The fact that n in equation (15) appears only as n^2 is a simple consequence of the anti-symmetrical character of U . For if in (13) we measure y from the centre and integrate between the limits $\pm \frac{1}{2}l$, we obtain in that case

$$\int_0^{\frac{1}{2}l} \frac{n^2/k^2 + U^2}{(n^2/k^2 - U^2)^2} dy = 0, \quad \quad (16)$$

in which only n^2 occurs. But it does not appear that n^2 is necessarily real, as happens in (15).

Apart from such examples as were treated in my former papers in which d^2U/dy^2 vanishes except at certain definite places, there are very few cases in which (3) can be solved analytically. If we suppose that $v = \sin(\pi y/l)$, vanishing when $y=0$ and when $y=l$, and seek what is then admissible for U , we get

$$U + n/k = A \cos \{k^2 + \pi^2/l^2\}^{\frac{1}{2}} y + B \sin \{k^2 + \pi^2/l^2\} y, \quad (17)$$

in which A and B are arbitrary and n may as well be supposed to be zero. But since U varies with k , the solution is of no great interest.

In estimating the significance of our results respecting stability, we must of course remember that the disturbance has been assumed to be and to remain infinitely small. Where stability is indicated, the magnitude of the admissible disturbance may be very restricted. It was on these lines that Kelvin proposed to explain the apparent contradiction between theoretical results for an inviscid fluid and observation of what happens in the motion of real fluids which are all more or less viscous. Prof. M.F. Orr has carried this explanation further*. Taking the case of a simple shearing motion between two walls, he investigates a composite disturbance, periodic with respect to x but not with respect to t , given initially as

$$v = B \cos lx \cos my, \quad \quad (18)$$

and he finds, equation (38), that when m is large the disturbance may increase very much, though ultimately it comes to zero. Stability in the mathematical sense (B infinitely small) may thus be not inconsistent with a practical

* Proc. Roy. Irish Academy, vol. xxvii. Section A, No. 2, 1907. Other related questions are also treated.

instability. A complete theoretical proof of instability requires not only a method capable of dealing with finite disturbances but also a definition, not easily given, of what is meant by the term. In the case of stability we are rather better situated, since by absolute stability we may understand complete recovery from disturbances of any kind however large, such as Reynolds showed to occur in the present case when viscosity is paramount*. In the absence of dissipation, stability in this sense is not to be expected.

Another manner of regarding the present problem of the shearing motion of an inviscid fluid is instructive. In the original motion the vorticity is constant throughout the whole space between the walls. The disturbance is represented by a superposed vorticity, which may be either positive or negative, and this vorticity everywhere *moves with the fluid*. At any subsequent time the same vorticities exist as initially; the only question is as to their distribution. And when this distribution is known, the whole motion is determined. Now it would seem that the added vorticities will produce most effect if the positive parts are brought together, and also the negative parts, as much as is consistent with the prescribed periodicity along x , and that even if this can be done the effect cannot be out of proportion to the magnitude of the additional vorticities. If this view be accepted, the temporary large increase in Prof. Orr's example would be attributed to a specially unfavourable distribution initially in which (m large) the positive and negative parts of the added vorticities are closely intermingled. We may even go further and regard the subsequent tendency to evanescence, rather than the temporary increase, as the normal phenomenon. The difficulty in reconciling the observed behaviour of actual fluids with the theory of an inviscid fluid still seems to me to be considerable, unless indeed we can admit a distinction between a fluid of infinitely small viscosity and one of none at all.

At one time I thought that the instability suggested by observation might attach to the stages through which a viscous liquid must pass in order to acquire a uniform shearing motion rather than to the final state itself. Thus in order to find an explanation of "skin friction" we may suppose the fluid to be initially at rest between two infinite fixed walls, one of which is then suddenly made to move in its own plane with a uniform velocity. In the earlier stages the other wall has no effect and the problem is one considered by Fourier in connexion with the conduction of heat. The

* See also Orr, Proc. Roy. Irish Acad. 1907, p. 124.

velocity U in the laminar motion satisfies generally an equation of the form

$$\frac{dU}{dt} = \frac{d^2U}{dy^2}, \dots \dots \dots (19)$$

with the conditions that initially ($t=0$) $U=0$, and that from $t=0$ onwards $U=1$ when $y=0$, and (if we please) $U=0$ when $y=l$. We might employ Fourier's solution, but all that we require follows at once from the differential equation itself. It is evident that dU/dt , and therefore d^2U/dy^2 , is everywhere positive and accordingly that a non-viscous liquid, moving laminarily as the viscous fluid moves in any of these stages, is stable. It would appear then that no explanation is to be found in this direction.

Hitherto we have supposed that the disturbance is periodic as regards x , but a simple example, not coming under this head, may be worthy of notice. It is that of the disturbance due to a single vortex filament in which the vorticity differs from the otherwise uniform vorticity of the neighbouring fluid. In the figure the lines AA, BB represent the situation

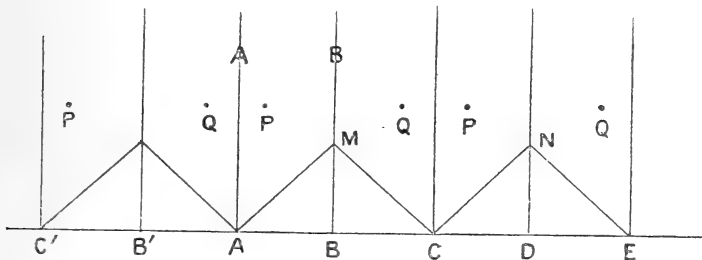

of the walls and AM the velocity-curve of the original shearing motion rising from zero at A to a finite value at M. For the present purpose, however, we suppose material walls to be absent, but that the same effect (of prohibiting normal motion) is arrived at by suitable suppositions as to the fluid lying outside and now imagined infinite. It is only necessary to continue the velocity-curve in the manner shown AMCN ..., the vorticity in the alternate layers of equal width being equal and opposite. Symmetry then shows that under the operation of these vorticities the fluid moves as if AA, BB, &c. were material walls.

We have now to trace the effect of an additional vorticity, supposed positive, at a point P. If the wall AA were alone concerned, its effect would be imitated by the introduction of an opposite vorticity at the point Q which is the image

of P in AA. Thus P would move under the influence of the original vorticities, already allowed for, and of the negative vorticity at Q. Under the latter influence it would move parallel to AA with a certain velocity, and for the same reason Q would move similarly, so that PQ would remain perpendicular to AA. To take account of both walls the more complicated arrangement shown in the figure is necessary, in which the points P represent equal positive vorticities and Q equal negative vorticities. The conditions at both walls are thus satisfied; and as before all the vortices P, Q move under each other's influence so as to remain upon a line perpendicular to AA. Thus, to go back to the original form of the problem, P moves parallel to the walls with a constant velocity, and no change ensues in the character of the motion—a conclusion which will appear the more remarkable when we remember that there is no limitation upon the magnitude of the added vorticity.

The same method is applicable—in imagination at any rate—whatever be the distribution of vorticities between the walls, and the corresponding velocity at any point is determined by quadratures on Helmholtz's principle. The new positions of all the vorticities after a short time is thus found, and then a new departure may be taken, and so on indefinitely.

XCI. *An Electromagnetic Hypothesis as to the Origin of Series Spectra.* By ARTHUR W. CONWAY, M.A., D.Sc., Professor of Mathematical Physics, University College, Dublin*.

INTRODUCTION.

THE following paper is an attempt to picture a model of an atom based on the classical electrodynamics which will illustrate some of the properties of spectral series. The principal difficulties in explaining a frequency formula of the type

$$\nu = A - B/(n + \mu)^2,$$

where

$$n = 1, 2, 3 \dots,$$

are three: (i.) The formula gives the frequency and not the square of the frequency; (ii.) no elastic or electrical system has a frequency equation of this type, the frequency

* Communicated by the Author.

increases as n increases and becomes infinite with n ; (iii.) the amount of radiation given out must obey Planck's law. As regards (i.), as pointed out by Lord Rayleigh, the difficulty can be overcome by making the frequency depend on the magnetic force; and as to (ii.) this paper is intended to point out a mode of connexion between the vibrations of elastic bodies and the above law. The question of energy being radiated according to Planck's law is dealt with in the last section of the paper, in which it is shown that the kinetic energy radiated is homogeneous and of amount $h\nu$ where h is a constant having the value 6.8×10^{-27} (Planck's constant being 6.5×10^{-27}). The atom considered is a "Thomson" atom rotating with a constant angular velocity. It is shown that all single negative electrons having circular orbits in such atoms have a constant angular momentum h/π . If the atom is supposed capable of executing elastic vibrations, reasons are given for supposing that the innermost nodal sphere in any mode will capture the electron. A frequency formula of the type

$$\nu = A - B/(n + \mu)^2$$

is arrived at, A depending on the external structure of the atom, B being the same for all atoms, and μ depending on the nature of the surface conditions for the elastic waves. The simplest form of atom—the sphere—and the simplest mode of vibration—the radial—is considered. It is possible that more complex conditions will give better results, and that this paper may suggest a mode of attacking this problem from this standpoint.

The question of the Zeeman effect is not considered, but for a discussion for this type of atom we may refer to Ritz (*Annalen der Physik*, 7. xxv. 1908, p. 660).

THE INTERNAL FORCES.

Let the volume density ρ of the spherical atom be a function of r only the distance from the centre, and let Ω be the angular velocity of the sphere supposed moving as a rigid body, the axis of rotation being taken as the axis of z . The rotation of the sphere produces a magnetic force (α, β, γ) which is the curl of a vector potential (F, G, H) defined inside the sphere by the equations

$$\nabla^2 F = 4\pi\rho\Omega y; \quad \nabla^2 G = -4\pi\rho\Omega x; \quad \nabla^2 H = 0.$$

Outside the sphere $F, G,$ and H are harmonic and on the

1012 Prof. A. W. Conway on an *Electromagnetic*
 sphere they are continuous. If we write P for the integral

$$\int_0^r \frac{4}{3} \pi \rho' \Omega r'^4 dr'$$

and Q for the integral

$$\int_r^a \frac{4}{3} \pi \rho' \Omega r' dr',$$

where a is the radius of the sphere, we can easily obtain

$$F = -\frac{y}{r^3} P - yQ; \quad G = \frac{x}{r^3} P + xQ; \quad H = 0$$

for points inside the sphere, and thus we get

$$\alpha = \frac{3xz}{r^5} P.$$

$$\beta = \frac{3yz}{r^5} P.$$

$$\gamma = \frac{2P}{r^3} + 2Q - \frac{3(x^2 + y^2)}{r^5} P.$$

If an electron of charge $-e$ can move about in this sphere subjected only to the electromagnetic forces, and if it describes a circular orbit with angular velocity ω so that its components of velocity are $(-y\omega, x\omega, 0)$ it experiences a mechanical force which is equal to the vector product of $(ey\omega, -ex\omega, 0)$ and (α, β, γ) , and thus we get the components

$$(1) \quad -e\omega x(2P/r^3 + 2Q) + 3e\omega/r^5(x^2 + y^2)Px$$

$$(2) \quad -e\omega y(2P/r^3 + 2Q) + 3e\omega/r^5(x^2 + y^2)Py$$

$$(3) \quad 3e\omega/r^5(x^2 + y^2)Pz.$$

It will be noticed that this force can be made up of (a) an attractive force intersecting the z -axis and at right angles to it, and (b) a *repulsive radial* force.

In addition to these forces of magnetic origin we have the electrostatic force. This is simply an *attractive radial* force the components of which are

$$-c^2 exR/r^3, \quad -c^2 eyR/r^3, \quad -c^2 ezR/r^3,$$

where c is the velocity of light and R is the integral

$$\int_0^r 4\pi \rho r'^2 dr'.$$

THE STEADY MOTIONS.

For a steady motion of the negative electron the orbit must be a circle having the z -axis as axis. In general, for this to take place the attractive electrostatic force must balance the repulsive mechanical force, and so we must have, if m be the mass of the electron,

$$\omega = 2e/m(P/r^3 + Q)$$

$$3\omega(x^2 + y^2)P/r^5 = c^2R/r^3.$$

We now make use of our assumption that the electric density of the interior of the atom is uniform and that the electron is moving in this region. On evaluating the integrals the above equations take the forms

$$\omega = \frac{2}{3} e/m.\Omega V_0 - \frac{4}{3}\pi\rho\Omega r^2. e/m. \quad . \quad . \quad . \quad (1)$$

$$\frac{2}{3}(x^2 + y^2)\omega\Omega = c^2 \quad . \quad . \quad . \quad . \quad (2)$$

where $V_0 = \int_0^a 4\pi\rho r' dr'$ denotes the potential of the atom at its centre. It will be noticed that (2) expresses the fact that in every steady motion the angular momentum of the negative electron has the same constant value.

It may be remarked that the theory of Bohr* starts with an assumption that the angular momentum of an electron about the centre of force is constant and equal to $h/2\pi$ where h is Planck's constant. In our theory the constant is found to be (within the limits of experimental error) h/π . The connexion between the two theories so very different from one another can be still more clearly shown when it is remembered that the frequency of the radiation emitted by the Bohr electron is one half of the frequency of rotation in the permanent state.

As regards the stability of these motions, one finds that two of the oscillations about the steady motion are apparently neutral and the third is stable.

A further question arises, that of the applicability of the above formulæ for high speeds. The formulæ for the magnetic forces are true no matter what magnitude Ω has. As for the motion of the negative electron, its velocity is of the order 10^{-3} of the velocity of light, so that its mass m may be taken to have its Newtonian value.

* Phil. Mag. July and Sept. 1913.

THE SERIES FORMULÆ.

If a gas be conceived to be made up of such atoms each one having an electron moving in it, those electrons which are moving in steady motion give out a radiation of definite period. The spectrum of such a gas would be continuous within certain limits. We now make the assumption that the atom is capable of elastic vibrations in the same way as an elastic sphere. Nodal surfaces will be set up, and it is only the electrons whose orbits lie on one of these nodal surfaces which can give out undisturbed a homogeneous radiation. Let us consider as an example that the atom vibrates in the same way as a spherical volume of gas under constant pressure. The nodal surfaces will then be spheres of radii r given by the equations

$$kr = 1.4303 \pi, 2.4590 \pi, \dots$$

where k is determined by an equation of the type

$$ka = n\pi$$

where n is an integer.

Of these nodal spheres, we shall see that only the innermost is likely to be effective in holding the electron. The orbits of electrons which can rotate undisturbed by the elastic vibrations are given by

$$r = 1.4303/n$$

where n is an integer. Thus the spectrum gets split into lines forming a series, the frequencies ν being given by the formula

$$\nu = e/3\pi m \cdot \Omega V_0 - \frac{2}{3}\rho\Omega a^2(1.4303)^2(e/m)/n^2 \dots (3)$$

where n is an integer.

This formula is of Balmer's form

$$r = A - B/n^2.$$

In a similar way we can imagine model atoms which will imitate to some extent some of the other properties of series. Suppose that the atom or sphere of positive electricity is covered with a uniform layer of negative electricity the density of which greater than the density of the positive electricity. The radial oscillation will be now of two kinds: (i.) forced oscillations due to the motion of the surface layer, for these oscillations we will have $ka = n\pi$; (ii.) oscillations in which the surface will be a nodal sphere for which

we have $\tan ka = ka$, the higher roots of which are approximately given by $ka = (n + \frac{1}{2})\pi$. The innermost nodal sphere is, in both cases, given by $kr = 1.4303\pi$.

(iii.) If the negative layer is taken off we have only *one* type of vibration, *i. e.* $ka = n\pi$, whilst the constant A has a greater value than before. We thus have three series, the formulæ for which are of the type

(i.) $\nu = A - \frac{B}{n^2}$. First subordinate (nebulous) series.

(ii.) $\nu = A - \frac{B}{(n + \frac{1}{2})^2}$. Second subordinate (sharp) series.

(iii.) $\nu = A' - \frac{B}{n^2}$. Principal series.

In reality it may be that the negative layer represents a shell or shells of negative electrons, and that the boundary conditions in complicated atoms will be slightly different although resembling those given above. Any change or rearrangement of the shells alters the constants A, which thus change from one element to another. The constant B, however, in our theory is universal, and thus we get an interpretation of Rydberg's constant.

According to the equation

$$B = \frac{2}{3}\rho\Omega a^2(1.4303)^2(e/m)$$

we might interpret this by saying that the electrical density and the angular velocity of the *core* of every atom is the same.

THE NODAL SURFACES.

We have now to consider in more detail the question of the nodal surfaces. If, still following the analogy of the elastic sphere, we make the assumption that the change of the electrical volume density is proportional to the change of density, *i. e.* proportional to $\sin kr/kr$, we get that the increase of electrical force at any point due to the oscillations

is proportional to $4\pi k^{-1}r^{-2} \int_0^r \sin kr r dr$, and the condition that this should vanish is $\tan kr = kr$. Hence the nodal surfaces employed above can have a purely electrical origin.

Coming now to the expressions for the magnetic force, we find that the integrals in question are of a less simple character on account of the fact that the conditions at the

boundary will come in. We obtain, however, on the same hypothesis the equation for the change of magnetic force

$$\frac{\sin kr}{kr} \left(1 - \frac{2}{k^2 r^2} \right) + \frac{2 \cos kr}{k^2 r^2} + c$$

where c is a constant. If this expression is always positive its graph will resemble a "damped" sine-curve the smallest ordinate of which will be at the point

$$kr = 1.2319 \pi.$$

Thus in the neighbourhood of this point the amplitude of the magnetic disturbance is smallest, and so of all the nodal surfaces

$$kr = 1.4303 \pi, 2.4590 \pi, \dots$$

it is only at the innermost that an electron will be capable of describing a steady orbit.

ON RADIATION.

We have seen above that all the steady motions are characterized by the same angular momentum. It remains to obtain a numerical estimate of this constant. From equation (2) we have the angular momentum

$$m(x^2 + y^2)\omega = 5c^2 m / 3\Omega,$$

and from equation (3) we have

$$\frac{2}{5} \rho \Omega^2 (1.4303)^2 (e/m) = B \text{ (Rydberg's constant).}$$

The density ρ is unknown but we shall take it to be given by the equation

$$e = 4/3 \cdot \pi \rho x^3.$$

If the angular momentum is denoted by h/π and if we insert the values

$$ec = 4.7 \times 10^{-10}; a = 10^{-8}; B = 3.29 \times 10^{15}$$

we find

$$h = 6.8 \times 10^{-27},$$

which agrees possibly within the limits of experimental error of some of the above quantities, with the value of Planck's constant 6.5×10^{-27} .

Some idea can now be formed as to the manner in which the radiation is given out. An electron having a frequency ν will have an amount $h\nu$ of kinetic energy. If at this

instant it finds itself on a nodal sphere, and if it is constrained to remain on this sphere by a force purely radial, then the magnetic force and *therefore* v remains constant, but owing to radiation the circular orbit continually diminishes until all the kinetic energy is radiated. During this process *the radiation given out is always of the same frequency and the total amount of it given out is $h\nu$* . The energy remaining now is potential and further radiation, if any, is of a different type.

XCII. *On the Long-wave Limits of the Normal Photoelectric Effect.* By Dr. R. POHL and Dr. P. PRINGSHEIM*.

IT was with the purpose of discovering the relations existing between the photoelectric properties of the illuminated molecules and their other characteristic properties, in particular their chemical behaviour, that the investigations on the photoelectric effect have been extended to a rather large number of elements. That the characteristic frequency of the selective effect, despite uncertainties in the position of the resonance maximum, is a material constant related to the atomic radius † has been pretty certainly established. But in the normal effect, as well, a constant which is characteristic of the material seems to enter. In connexion with Lenard's ‡ pioneer investigations on the velocity of electronic emission, Einstein § in 1905 developed a theory for the normal effect (the selective was then unknown) in which such a characteristic constant occurs. According to this theory, the initial velocity of the electrons for a given frequency, ν , is given by an equation of the form

$$\frac{m}{2}v^2 = h\nu - p = eP,$$

in which v is the velocity of the electrons e and P the maximum potential to which the illuminated plate becomes charged. Putting $p = h\nu_0$, we see at once that ν_0 is the smallest frequency which the incident light can have and liberate electrons with a velocity $v = 0$. ν_0 is a constant characteristic of the material in the normal effect.

* Communicated by the Authors.

† ν_0 is probably proportional to r^{-1} .

‡ Ph. Lenard, *Ann. d. Phys.* viii. p. 149 (1902).

§ A. Einstein, *Ann. d. Phys.* xx. p. 199 (1905).

Joffé *, somewhat later, pointed out that the values for the photoelectric initial velocities published by E. Ladenburg † in 1907 could be just as well represented by Einstein's formula as by the formula originally adopted by Ladenburg, according to which the velocity itself and not the square of the velocity is proportional to the frequency. Since that time a great many papers have appeared in which this question of proportionality was thought to have been conclusively settled. In our opinion, however, no great advance in this direction has been made over the results of Joffé and of Ladenburg. As an instance of the uncertainty, Mr. Kunz at first believed his measurements verified Einstein's formula ‡, but later, on the basis of a theory of his own, proposed a relation according to which P increased proportionally to ν^2 , and also verified this relation experimentally §. Actually, though, his results may be equally well represented by either formula. Indeed, as Compton || has recently pointed out, the values obtained by Kunz's pupil Cornelius ¶ for Cs and K correspond even better to a proportionality of P with ν^2 . Nor do the results which Richardson & Compton ** in their joint paper give for, say, Al lead in our opinion to a definite conclusion. As curves 1 and 2, fig. 1, show, they may be represented with approximately the same accuracy either by a linear or by a quadratic relation ††. In particular the accuracy of the value for $\lambda=200\mu\mu$, which would perhaps speak more for the linear relation, cannot be very great on account of the very small energy of the radiation from a quartz-Hg lamp in this region of the spectrum. This same criticism applies in an even greater measure to the measurements of Hughes ††† on Cd, which are plotted as curves 3 and 4, fig. 1, and in which the point corresponding to $\lambda=185\mu\mu$ §§ would seem to

* A. Joffé, *Ann. d. Phys.* xxiv. p. 939 (1907).

† E. Ladenburg, *Verh. d. D. Phys. Ges.* ix. p. 504 (1907).

‡ I. Kunz, *Phys. Rev.* xxix. p. 212 (1909).

§ I. Kunz, *Phys. Rev.* xxxiii. p. 208 (1911).

|| K. T. Compton, *Phys. Rev.* [2] i. p. 382 (1913).

¶ D. W. Cornelius, *Phys. Rev.* [2] i. p. 16 (1913).

** O. Richardson & K. T. Compton, *Phil. Mag.* [6] xxiv. p. 575 (1912).

†† It may be mentioned that the values given by Richardson and Compton are even in far better agreement with the formula

$$P = \text{const.} \log \nu - p.$$

††† A. Ll. Hughes, *Phil. Trans. Roy. Soc. London*, A. cxxii. p. 205 (1912).

§§ It may here be noted that the Hg line $\lambda=185\mu\mu$, whose discovery Mr. Hughes describes in *Proc. Camb. Phil. Soc.* xvi. p. 428 (1912), had been already reported in 1909 by Fritz Handke in his *Berliner Dissertation*, and by Th. Lyman, *Astrophys. Journ.* xxxiii. p. 106 (1911).

indicate rather conclusively an agreement with Einstein's formula. Indeed, it is well known how extremely small is the energy of the radiation from a quartz lamp for wave-lengths less than $\lambda = 200\mu\mu$, especially after passage through

Fig. 1.

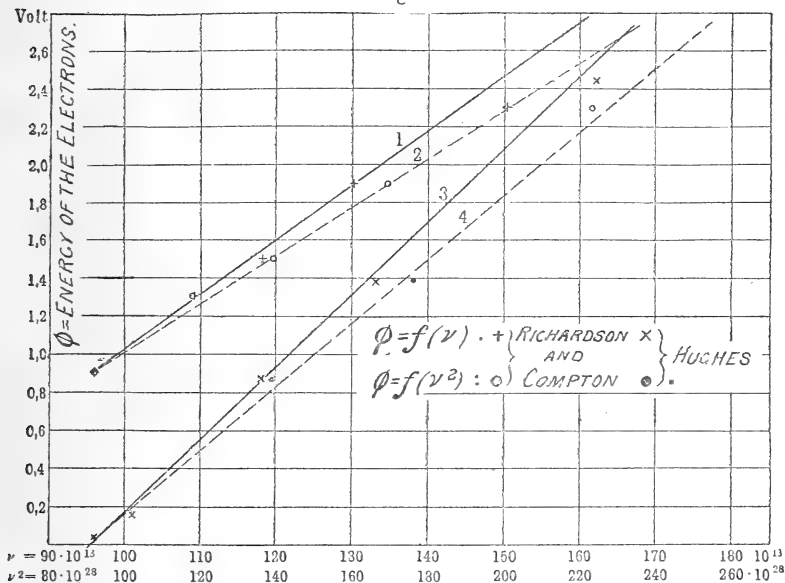

a quartz spectroscope. It must therefore be regarded as very doubtful whether in such cases the insulation losses and the losses due to charges resulting from stray light diffused to the opposite electrode, can be so completely eliminated that the illuminated plate actually assumes the high potentials corresponding to these very short wave-lengths. However, the foregoing must not in any way be construed as a criticism of the validity of Einstein's formula. It merely seems to us that the measurements thus far made in the spectral region between $185\mu\mu$ and $400\mu\mu$ do not lend themselves to a quantitative test. We consider that at present the most important experimental support for Einstein's relation is the fact that an extrapolation to the probable frequencies of the Röntgen spectrum leads to velocities for the electrons liberated by Röntgen rays which agree in order of magnitude with those experimentally observed*.

* W. Wien, *Götting. Nachr.* pp. 598-601 (1907); J. Stark, *Phys. Zs.* p. 881 (1907); cf. R. Pohl, *Physik der Röntgenstrahlen*, Braunschweig, 1912, p. 128.

At all events, however, the measurements thus far made indicate a relation of the form

$$eP = f(\nu) - p$$

between the initial velocity of the electrons and the frequency of the light. In this equation f is a function which increases with its argument according to some arbitrary law, and p , entirely independently of the exact form of this function, gives, as noted above, the least energy which the electron can have and escape from the metal. Einstein, in the paper already cited, has pointed out that the quantity p must be intimately connected with the contact potential of the particular metal under consideration. In fact, Elster and Geitel* many years before proved experimentally that all electropositive metals were photoelectrically sensitive far into the visible spectrum, that is, for these metals the energy of separation, p , of the electrons is relatively small. Later the writers succeeded in showing by quantitative measurements with spectrally resolved light, that the metals with respect to the long-wave limits of their photoelectric sensibility can be arranged in a series which agrees pretty closely with the voltaic contact potential series †. We were also able to demonstrate that a chemical combination of K with more electronegative elements displaces the long-wave limit of the normal effect further toward higher frequencies the more electronegative the second component is, and that the magnitude of this displacement could be regarded as a measure of the chemical affinity ‡. In this connexion it is still uncertain whether it is admissible to speak of a sudden well-defined cessation of the effect at a perfectly definite wave-length, or whether it were not better to speak of a gradual asymptotic approach of the curve to the zero axis. In this latter case the observed limit would be, to a certain extent at least, dependent on the sensibility of the measuring instruments. At all events, however, the recent investigations by Joffé § on metal particles in suspension seem to point to a very rapid decrease in the photoelectric sensitiveness at the limit, since by his method the escape of each individual electron is registered. The limit of sensitiveness, $\lambda = 380 \mu\mu$, for Zn, as given by him, fits in very

* J. Elster & H. Geitel, *Wied. Ann.* xliii. p. 225 (1891).

† R. Pohl & P. Pringsheim, *Verh. d. D. Phys. Ges.* xiii. p. 474 (1911).

‡ R. Pohl & P. Pringsheim, *Verh. d. D. Phys. Ges.* xii. p. 1039 (1910). The existence of such a relation was later suggested as probable by Mr. Hughes, *Phil. Mag.* [6] xxiv. p. 380 (1912).

§ A. Joffé, *Ber. d. Bayr. Akad. München*, 1913, p. 19.

well with our series of observations, in which the limit for the but little more electronegative Sn is given as $\lambda = 370 \mu\mu$. Recently Richardson and Compton have noted a similar regularity, although the absolute values for the limiting wave-lengths lie sensibly more toward the ultraviolet, probably because the metallic surfaces investigated by them were not so free from impurities.

Although such a relation between the position of a metal in the Volta series and its limit of photoelectric sensitiveness, that is, the energy of separation of the electrons, certainly does exist, it seems to us premature to attempt to build up a quantitative theory from the absolute measured values of these limits. First because, as already noted, it is almost impossible to determine when the surfaces of the metals under observation are actually free from impurities. To illustrate, a Ca surface prepared by Hughes by distillation in a vacuum ceased to be photoelectrically sensitive at $\lambda = 365 \mu\mu$, whereas a Ca surface prepared by us in an exactly similar manner gave a copious emission of electrons with visible light. But not only do the absolute values vary widely from surface to surface, but they are not always constant for the same surface. We reported such a variation in the surface of Mg and Al mirrors recently*. Immediately after their production these mirrors always ceased to be sensitive at the boundary of the visible spectrum, but after standing for some time in a vacuum the same surfaces would emit electrons when illuminated with even infra-red rays.

We have also described a similar time displacement of the sensitivity limit through almost an octave—from about $400 \mu\mu$ to over $700 \mu\mu$ —in the case of distilled Ca†. Quite recently we have found that a liquid Ca amalgam possessed this same property. When such an amalgam is freshly put into the cell, its photoelectric sensitiveness ceases at about $\lambda = 350 \mu\mu$. Within a few minutes, however, the limit of sensitiveness moves toward the visible spectrum, and after a somewhat longer time (about one hour) has reached into the infra-red. If, then, by shaking the cell a new surface is exposed, it exhibits again the original sensitiveness only to pass through the same changes as before.

Measurements showing the progress of the sensitivity limit of such a Ca surface are given in Table I. and fig. 2. Energetic heating accelerated the process. The addition of foreign gases to the cell (which naturally during the

* R. Pohl & P. Pringsheim, *Verh. d. D. Phys. Ges.* xiv. p. 546 (1912).

† R. Pohl & P. Pringsheim, *Verh. d. D. Phys. Ges.* xv. p. 111 (1913).

TABLE I.

Total charge of the electrons liberated by 1 cal. of incident light 10^{-4} coul.

Wave-length μ .	Fresh surface of Ca.	20 min. after preparation.	45 min. after preparation.	110 min. after preparation.	Surface renewed by shaking.	100 min. later.
230	3.63	5.65	6.2	6.6	4.43	7.21
254	2.61	4.1	4.37	5.07	2.58	5.14
313	0.336	1.79	3.12	3.6	0.6	3.84
305	0	1.15	2.48	3.1	0	3.26
405	—	0.63	1.8	2.39	—	2.64
436	—	0.43	1.58	1.96	—	2.3
546	—	0	0.41	0.63	—	0.72
Nr.	3889-3892	3893-3899	3900-3906	3909-3915	3923-3927	3934-3940

Fig. 2.

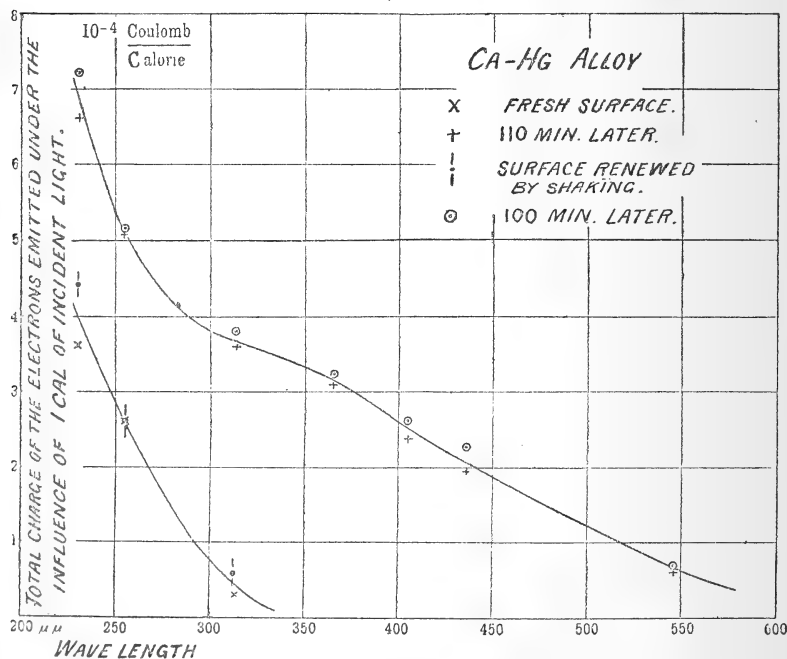

actual measurements was highly evacuated) has as yet shown no effect except, as in the case of O_2 , when the surface was attacked and rendered entirely insensitive. Here, therefore, one has to do with an effect which is

not analogous to that recently described by us, which dealt with the surface changes produced on K by reaction with electronegative gases*. Neither K nor K-amalgams, which we had occasion to investigate extensively in another connexion †, show this time change of surface observed on Ca. If the effect is there, it is at any rate of an entirely different order of magnitude. On the other hand, observations, not yet published, which have been made on Li-amalgams indicate a behaviour similar to that observed on Ca-amalgams.

S. Werner ‡ has observed a similar, though much smaller, displacement of the maximum wave-length capable of liberating electrons on Pt and Cu. Under any circumstances it must be concluded from these observations that, even on such well-defined surfaces as metals distilled in a vacuum would seem to have, the quantity p , the energy of separation of the electrons, cannot be satisfactorily measured. The expediency of any attempt to bring the results obtained for p into relationship with the heat of vaporization of the electrons as derived from Richardson's thermionic theory § is therefore very questionable. At all events, it would seem entirely inadmissible to calculate by this method the energy of separation for a metal, and from this by extrapolation to conclude as to the correctness or non-correctness of Einstein's formula, as Compton has done. Especially is this the case since one would thereby be led to the conclusion that K should cease to be photoelectrically sensitive at $\lambda = 600 \mu\mu$ ||, whereas Elster & Geitel ¶ in an extensive investigation have followed the—almost certainly normal—emission of K into the infra-red.

Summary.

From the experimental data at present known, it may be regarded as pretty firmly established that the long-wave limit of the normal photoelectric effect furnishes a measure of the binding force between the electrons and the illuminated molecule. On the other hand, any attempt to formulate this relation quantitatively is met with the difficulty that the values for the long-wave limits of the normal photoelectric

* R. Pohl & P. Pringsheim, *Verh. d. D. Phys. Ges.* xv. p. 625 (1913).

† R. Pohl & P. Pringsheim, *Verh. d. D. Phys. Ges.* xv. p. 431 (1913).

‡ S. Werner, *Arkiv för Matematik, Astronomi, och Fysik*, viii. No. 27, Upsala, 1912.

§ O. Richardson, *Phil. Mag.* xxiv. p. 570 (1912).

|| K. T. Compton, *Phys. Rev.* i. p. 382 (1913).

¶ J. Elster & H. Geitel, *Phys. Zs.* xii. p. 758 (1911).

effect in the case of many metals and alloys are subject to variations as great as an octave and more. This difficulty is all the more real in that as yet we are not in a position to determine what influences on and in the extremely thin bounding surface of the metal in which the light absorption takes place are the determining factors in this displacement.

Berlin, Physikalisches Institut
der Universität, July 1913.

XCI. *The High-Frequency Spectra of the Elements.*

By H. G. J. MOSELEY, M.A.*

[Plate XXIII.]

IN the absence of any available method of spectrum analysis, the characteristic types of X radiation, which an atom emits when suitably excited, have hitherto been described in terms of their absorption in aluminium †. The interference phenomena exhibited by X rays when scattered by a crystal have now, however, made possible the accurate determination of the frequencies of the various types of radiation. This was shown by W. H. and W. L. Bragg ‡, who by this method analysed the line spectrum emitted by the platinum target of an X-ray tube. C. G. Darwin and the author § extended this analysis and also examined the continuous spectrum, which in this case constitutes the greater part of the radiation. Recently Prof. Bragg || has also determined the wave-lengths of the strongest lines in the spectra of nickel, tungsten, and rhodium. The electrical methods which have hitherto been employed are, however, only successful where a constant source of radiation is available. The present paper contains a description of a method of photographing these spectra, which makes the analysis of the X rays as simple as any other branch of spectroscopy. The author intends first to make a general survey of the principal types of high-frequency radiation, and then to examine the spectra of a few elements in greater detail and with greater accuracy. The results already obtained show that such data have an important bearing on the question of

* Communicated by Prof. E. Rutherford, F.R.S.

† Cf. Barkla, *Phil. Mag.* xxii. p. 396 (1911).

‡ *Proc. Roy. Soc. A.* lxxxviii. p. 428 (1913).

§ *Phil. Mag.* xxvi. p. 210 (1913).

|| *Proc. Roy. Soc. A.* lxxxix. p. 246 (1913).

the internal structure of the atom, and strongly support the views of Rutherford* and of Bohr †.

Kaye ‡ has shown that an element excited by a stream of sufficiently fast cathode rays emits its characteristic X radiation. He used as targets a number of substances mounted on a truck inside an exhausted tube. A magnetic device enabled each target to be brought in turn into the line of fire. This apparatus was modified to suit the present work. The cathode stream was concentrated on to a small area of the target, and a platinum plate furnished with a fine vertical slit placed immediately in front of the part bombarded. The tube was exhausted by a Gaede mercury pump, charcoal in liquid air being also sometimes used to remove water vapour. The X rays, after passing through the slit marked S in fig. 1,

Fig. 1.

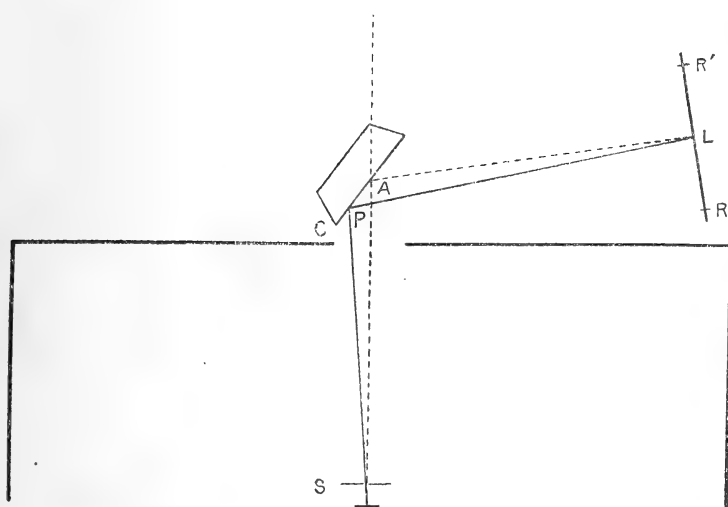

emerged through an aluminium window .02 mm. thick. The rest of the radiation was shut off by a lead box which surrounded the tube. The rays fell on the cleavage face, C, of a crystal of potassium ferrocyanide which was mounted on the prism-table of a spectrometer. The surface of the crystal was vertical and contained the geometrical axis of the spectrometer.

* *Phil. Mag.* xxi. p. 669 (1911).

† *Phil. Mag.* xxvi. pp. 1, 476, & 857 (1913).

‡ *Phil. Trans. Roy. Soc. A.* ccix. p. 123 (1909).

Now it is known* that X rays consist in general of two types, the heterogeneous radiation and characteristic radiations of definite frequency. The former of these is reflected from such a surface at all angles of incidence, but at the large angles used in the present work the reflexion is of very little intensity. The radiations of definite frequency, on the other hand, are reflected only when they strike the surface at definite angles, the glancing angle of incidence θ , the wavelength λ , and the "grating constant" d of the crystal being connected by the relation

$$n\lambda = 2d \sin \theta, \quad (1)$$

where n , an integer, may be called the "order" in which the reflexion occurs. The particular crystal used, which was a fine specimen with face 6 cm. square, was known to give strong reflexions in the first three orders, the third order being the most prominent.

If then a radiation of definite wave-length happens to strike any part P of the crystal at a suitable angle, a small part of it is reflected. Assuming for the moment that the source of the radiation is a point, the locus of P is obviously the arc of a circle, and the reflected rays will travel along the generating lines of a cone with apex at the image of the source. The effect on a photographic plate L will take the form of the arc of an hyperbola, curving away from the direction of the direct beam. With a fine slit at S, the arc becomes a fine line which is slightly curved in the direction indicated.

The photographic plate was mounted on the spectrometer arm, and both the plate and the slit were 17 cm. from the axis. The importance of this arrangement lies in a geometrical property, for when these two distances are equal the point L at which a beam reflected at a definite angle strikes the plate is independent of the position of P on the crystal surface. The angle at which the crystal is set is then immaterial so long as a ray can strike some part of the surface at the required angle. The angle θ can be obtained from the relation $2\theta = 180^\circ - \text{SPL} = 180^\circ - \text{SAL}$.

The following method was used for measuring the angle SAL. Before taking a photograph a reference line R was made at both ends of the plate by replacing the crystal by a lead screen furnished with a fine slit which coincided with the axis of the spectrometer. A few seconds' exposure to the X rays then gave a line R on the plate, and so defined on it

* Moseley and Darwin, *loc. cit.*

the line joining S and A. A second line R' was made in the same way after turning the spectrometer arm through a definite angle. The arm was then turned to the position required to catch the reflected beam and the angles LAP for any lines which were subsequently found on the plate deduced from the known value of RAP and the position of the lines on the plate. The angle LAR was measured with an error of not more than $0^{\circ}.1$, by superposing on the negative a plate on which reference lines had been marked in the same way at intervals of 1° . In finding from this the glancing angle of reflexion two small corrections were necessary in practice, since neither the face of the crystal nor the lead slit coincided accurately with the axis of the spectrometer. Wave-lengths varying over a range of about 30 per cent. could be reflected for a given position of the crystal.

In almost all cases the time of exposure was five minutes. Ilford X-ray plates were used and were developed with rodinal. The plates were mounted in a plate-holder, the front of which was covered with black paper. In order to determine the wave-length from the reflexion angle θ it is necessary to know both the order n in which the reflexion occurs and the grating constant d . n was determined by photographing every spectrum both in the second order and the third. This also gave a useful check on the accuracy of the measurements; d cannot be calculated directly for the complicated crystal potassium ferrocyanide. The grating constant of this particular crystal had, however, previously* been accurately compared with d' , the constant of a specimen of rocksalt. It was found that

$$d = 3d' \frac{.1988}{.1985}.$$

Now W. L. Bragg † has shown that the atoms in a rock-salt crystal are in simple cubical array. Hence the number of atoms per c.c.

$$2 \frac{N\sigma}{M} = \frac{1}{(d')^3}:$$

N , the number of molecules in a gram-mol., $= 6.05 \times 10^{23}$, assuming the charge on an electron to be 4.89×10^{-10} ; σ , the density of this crystal of rocksalt, was 2.167, and M the molecular weight $= 58.46$.

* Moseley & Darwin, *loc. cit.*

† Proc. Roy. Soc. A. lxxxix. p. 248 (1913).

TABLE I.

Element.	Line.	θ_2 .	λ .	θ_3 .	λ .	λ .	λ_d/λ_β .	$Q = (\nu/\lambda^2\nu_0)^3$.	N atomic number.	Atomic weight.
CALCIUM.	α ...	23.4°	3.357×10^{-8}	36.7°	3.368×10^{-8}	3.094	1.089	19.00	20	40.09
	β ...	21.4	3.035	33.3	21	44.1
SCANDIUM.
TITANIUM.	α ...	19.1	2.766	29.3	2.758	2.524	1.093	20.99	22	48.1
	β ...	17.4	2.528	26.6
VANADIUM.	α ...	17.35	2.521	26.55	2.519	2.297	1.097	21.96	23	51.06
	β ...	15.8	2.302	24.05
CHROMIUM.	α ...	15.75	2.295	24.1	2.301	2.093	1.100	22.98	24	52.0
	β ...	14.3	2.088	21.8
MANGANESE.	α ...	14.5	2.117	22.0	2.111	1.918	1.101	23.99	25	54.93
	β ...	13.15	1.923	19.9
IRON.	α ...	13.3	1.945	20.2	1.946	1.765	1.103	24.99	26	55.85
	β ...	12.05	1.765	18.25
COBALT.	α ...	12.25	1.794	18.6	1.798	1.629	1.104	26.00	27	58.97
	β ...	11.15	1.635	16.8
NICKEL.	α ...	11.35	1.664	17.15	1.662	1.506	1.104	27.04	28	58.68
	β ...	10.25	1.504	15.5
COPPER.	α ...	10.55	1.548	15.95	1.549	1.402	1.105	28.01	29	63.57
	β ...	9.55	1.403	14.4
ZINC.	α ...	9.85	1.446	14.85	1.445	1.306	1.106	29.01	30	65.37
	β ...	not	found	13.4

This gives $d' = 2.814 \times 10^{-8}$ and $d = 8.454 \times 10^{-8}$ cm. It is seen that the determination of wave-length depends on $e^{\frac{1}{2}}$, so that the effect of uncertainty in the value of this quantity will not be serious. Lack of homogeneity in the crystal is a more likely source of error, as minute inclusions of water would make the true density greater than that found experimentally.

Twelve elements have so far been examined. The ten given in Table I. were chosen as forming a continuous series with only one gap. It was hoped in this way to bring out clearly any systematic results. The inclusion of nickel was of special interest owing to its anomalous position in the periodic system. Radiations from these substances are readily excited, and the large angles of reflexion make it easy to measure the wave-lengths with accuracy. Calcium alone gave any trouble. In this case, owing to the high absorption coefficient of the principal radiation—about 1200 cm.^{-1} in aluminium—the X-ray tube was provided with a window of goldbeaters' skin and the air between the crystal and the photographic plate displaced by hydrogen. The layer of lime which covered the surface of the metal gave off such a quantity of gas that the X rays could only be excited for a second or two at a time. Brass was substituted for zinc to avoid volatilization by the intense heat generated at the point struck by the cathode rays. Ferro-vanadium (35 per cent. V) and ferro-titanium (23 per cent. Ti), for which I am indebted to the International Vanadium Co., proved convenient substitutes for the pure elements, which are not easily obtained in the solid form.

Plate XXIII. shows the spectra in the third order placed approximately in register. Those parts of the photographs which represent the same angle of reflexion are in the same vertical line. The actual angles can be taken from Table I. It is to be seen that the spectrum of each element consists of two lines. Of these the stronger has been called α in the table, and the weaker β . The lines found on any of the plates besides α and β were almost certainly all due to impurities. Thus in both the third and second order the cobalt spectrum shows Ni α very strongly and Fe α faintly. In the third order the nickel spectrum shows Mn α_2 faintly. The brass spectra naturally show α and β both of Cu and of Zn, but Zn β_2 has not yet been found. In the second order the ferro-vanadium and ferro-titanium spectra show very intense third-order Fe lines, and the former also shows Cu α_3 faintly. The Co contained Ni and 0.8 per cent. Fe, the Ni 2.2 per cent. Mn,

and the V only a trace of Cu. No other lines have been found; but a search over a wide range of wave-lengths has been made only for one or two elements, and perhaps prolonged exposures, which have not yet been attempted, will show more complex spectra. The prevalence of lines due to impurities suggests that this may prove a powerful method of chemical analysis. Its advantage over ordinary spectroscopic methods lies in the simplicity of the spectra and the impossibility of one substance masking the radiation from another. It may even lead to the discovery of missing elements, as it will be possible to predict the position of their characteristic lines.

It will be seen from Table I. that the wave-lengths calculated from the two orders are in good agreement. The third order gives the stronger reflexion, and as the angles dealt with are the larger these results are the more accurate. The similarity of the different spectra is shown by the fact that the two lines α and β remain approximately constant, not only in relative intensity but also in relative wave-length. The frequency of β increases, however, slightly faster than that of α . The same two lines α strong and β weak constitute the rhodium spectrum examined by Bragg*, and they are obviously in some way closely related. One or two photographs taken with the radiation from platinum gave results in good agreement with those obtained by the electrical method, and no trace of the elaborate system of bands described by de Broglie † in the reflexion from rock-salt was encountered. The three lines found by Herveg ‡ in the reflexion from selenite doubtless represent part of the Pt spectrum in the second order. The actual breadth of the lines and certain minute details in their structure will not be considered here, as discussion would take too much space and more experiments are needed. The only other element examined was tantalum. In this case the radiation belongs to the L series, and the spectrum consists of a strong line of wave-length 1.525×10^{-8} cm., two others of less intensity at 1.330 and 1.287×10^{-8} cm., and probably some very faint lines also.

A discussion will now be given of the meaning of the wave-lengths found for the principal spectrum-line α . In Table I. the values are given of the quantity

$$Q = \sqrt{\frac{\nu}{\frac{3}{4}\nu_0}}$$

* Proc. Roy. Soc. A. lxxxix. p. 277 (1913).

† *Le Radium*, x, pp. 186 & 245 (1913).

‡ *Deutsch. Phys. Ges. Verh.* xv, 13, p. 555 (1913).

ν being the frequency of the radiation α , and ν_0 the fundamental frequency of ordinary line spectra. The latter is obtained from Rydberg's wave-number, $N_0 = \frac{\nu}{c} = 109,720$.

The reason for introducing this particular constant will be given later. It is at once evident that Q increases by a constant amount as we pass from one element to the next, using the chemical order of the elements in the periodic system. Except in the case of nickel and cobalt *, this is also the order of the atomic weights. While, however, Q increases uniformly the atomic weights vary in an apparently arbitrary manner, so that an exception in their order does not come as a surprise. We have here a proof that there is in the atom a fundamental quantity, which increases by regular steps as we pass from one element to the next. This quantity can only be the charge on the central positive nucleus, of the existence of which we already have definite proof. Rutherford has shown, from the magnitude of the scattering of α particles by matter, that this nucleus carries a + charge approximately equal to that of $\frac{A}{2}$ electrons, where A is the atomic weight. Barkla, from the scattering of X rays by matter, has shown that the number of electrons in an atom is roughly $\frac{A}{2}$, which for an electrically neutral atom comes to the same thing. Now atomic weights increase on the average by about 2 units at a time, and this strongly suggests the view that N increases from atom to atom always by a single electronic unit. We are therefore led by experiment to the view that N is the same as the number of the place occupied by the element in the periodic system. This atomic number is then for H 1 for He 2 for Li 3... for Ca 20... for Zn 30, &c. This theory was originated by Broek † and since used by Bohr ‡. We can confidently predict that in the few cases in which the order of the atomic weights A clashes with the chemical order of the periodic system, the chemical properties are governed by N ; while A is itself probably a complicated function of N . The very close similarity between the X-ray spectra of the different elements shows that these radiations originate inside the atom, and have no direct connexion with the complicated light-spectra and chemical properties which are governed by the structure of its surface.

* Cf. Barkla, *Phil. Mag.* xiv. p. 408 (1907).

† *Phys. Zeit.* xiv. p. 32 (1913).

‡ *Loc. cit.*

We will now examine the relation

$$Q = \sqrt{\frac{\nu}{\frac{3}{4}\nu_0}}$$

more closely. So far the argument has relied on the fact that Q is a quantity which increases from atom to atom by equal steps. Now Q has been obtained by multiplying $\nu^{\frac{3}{2}}$ by a constant factor so chosen as to make the steps equal to unity. We have, therefore,

$$Q = N - k,$$

where k is a constant. Hence the frequency ν varies as $(N - k)^2$. If N for calcium is really 20 then $k = 1$.

There is good reason to believe that the X-ray spectra with which we are now dealing come from the innermost ring of electrons*. If these electrons are held in equilibrium by mechanical forces, the angular velocity ω with which they are rotating and the radius r of their orbit are connected by

$$m\omega^2 r = \frac{e^2}{r^2} (N - \sigma_n),$$

where σ_n is a small term arising from the influence of the n electrons in the ring on each other, and $\sigma_2 = 0.25$, $\sigma_4 = 0.96$, $\sigma_6 = 1.83$, $\sigma_8 = 2.81$. In obtaining this simple expression the very small effect of other outside rings has been neglected. If then, as we pass from atom to atom, the number of electrons in the central ring remains unaltered,

$$(\omega^2 r^3)_{N+1} - (\omega^2 r^3)_N \text{ remains constant;}$$

but these experiments have shown that

$$\nu_{N+1}^{\frac{1}{2}} - \nu_N^{\frac{1}{2}} \text{ is also constant,}$$

and therefore

$$\frac{\omega^2 r^3}{\nu^{\frac{1}{2}}} \text{ is constant.}$$

For the types of radiation considered by Bohr, provided the ring moves from one stationary state to another as a whole, and for the ordinary transverse vibrations of the ring, provided the influence of outer rings can be neglected, ν is proportional to ω .

This gives $\omega^{\frac{3}{2}} r^3$ and therefore $m\omega r^2$, the angular momentum of an electron, the same for all the different atoms. Thus we

* J. J. Thomson, Phil. Mag. xxiii. p. 456 (1912).

have an experimental verification of the principle of the constancy of angular momentum which was first used by Nicholson *, and is the basis of Bohr's theory of the atom.

It is evident that $k = \sigma_n$. If then $k = 1$, it is suggested that the ring contains 4 electrons, for $\sigma_4 = 0.96$.

We are now justified in making a quantitative comparison between the frequency of α and that of the fundamental radiation from such a ring calculated from the theory of Bohr.

We have obtained the experimental result,

$$\nu = \frac{3}{4} \nu_0 (N - \sigma_n)^2.$$

On his theory, making the assumption that the ring moves as a whole from stationary state 2 to state 1, the frequency of the principal radiation emitted is

$$\nu = \left(\frac{1}{1^2} - \frac{1}{2^2} \right) \frac{2\pi^2 e^4 m}{h^3} (N - \sigma_n)^2,$$

where e is the charge on an electron, m its mass, and h Planck's constant.

The numerical agreement between these two constants ν_0 and $\frac{2\pi^2 e^4 m}{h^3}$ is known to be very close, while Bohr's explanation of the Balmer series for hydrogen assumes them to be identical. This numerical agreement between the experimental values and those calculated from a theory designed to explain the ordinary hydrogen spectrum is remarkable, as the wave-lengths dealt with in the two cases differ by a factor of about 2000. The assumption that the whole ring takes part in the radiation introduces, however, a grave difficulty from energy considerations, while no explanation of the faint line β has been forthcoming. Probably further experiments will show that the theory needs some modification.

The results hitherto obtained for the radiations of the L series are too meagre to justify any explanation. As before, the line of longest wave-length is the most prominent, a result similar to that found in ordinary light-spectra. The wave-lengths found for this line in the case of tantalum and platinum suggest that possibly the frequency is here

$$\nu = \left(\frac{1}{2^2} - \frac{1}{3^2} \right) \nu_0 (N - \sigma_n)^2.$$

Here N and σ_n are unknown, but it is evident from the periodic system that $N_{Pt} - N_{Ta} = 5$, while probably σ_n remains

* Monthly Notes Roy. Astr. Soc. June 1912.

the same for all elements in the same column. The actual value found for $v_{Pt}^{\frac{1}{2}} - v_{Ta}^{\frac{1}{2}}$ is 1.08×10^8 , and the calculated value is 1.07×10^8 . Whether this relation really holds good can only be decided by further experiment.

In conclusion I wish to express my warm thanks to Prof. Rutherford for the kind interest which he has taken in this work.

Physical Laboratory,
University of Manchester.

XCV. *Ionization of Gases by Collision with Low Electric Forces.* By F. W. WHEATLEY, B.A., B.Sc. (Adelaide), Lincoln College, Oxford*.

[Plate XXIV.]

PROFESSOR TOWNSEND in his book 'The Theory of Ionization of Gases by Collision' has shown that the process of ionization by collision between the ions and molecules of a gas may be examined by investigating the currents between parallel plate electrodes when ultraviolet light falls on the negative electrode or when the gas is ionized by Röntgen or Becquerel rays.

In the determinations which have already been made, the effect of the electrons for values of the ratio X/p larger than 60 has been obtained.

The experiments described in this paper were undertaken with a view to finding the effects obtained by collision with smaller forces, and for that purpose it is necessary to measure the currents between plates at various distances apart to a high degree of accuracy. A very constant source of radiation is therefore required for the experiments, and it would be practically impossible to obtain reliable results either with ultraviolet light or with Röntgen rays.

The source of radiation used was polonium. The results show that the ionization produced by α rays is identical with that produced by Röntgen or Becquerel rays or by ultraviolet light, and has this advantage that it produces a constant current.

The apparatus which was used is shown in the accompanying figure and consisted of two parallel brass plates B and C inside an airtight bell-jar A. The bell-jar was provided with two outlets D and E. Through D a wire passed connecting the lower plate C to a source of potential V. The opening E led to a Töpler pump, an open manometer and a MacLeod gauge, and could also be connected

* Communicated by Prof. J. S. Townsend, F.R.S.

to the gas-supply. The plate B was surrounded by a guarding ring GG, earthed through the brass plate HH which closed the upper part of the bell-jar. From B a brass rod F passed through an ebonite plug in HH and was connected to one pair of quadrants of a Dolezalek electrometer, the other pair being earthed.

Fig. 1.

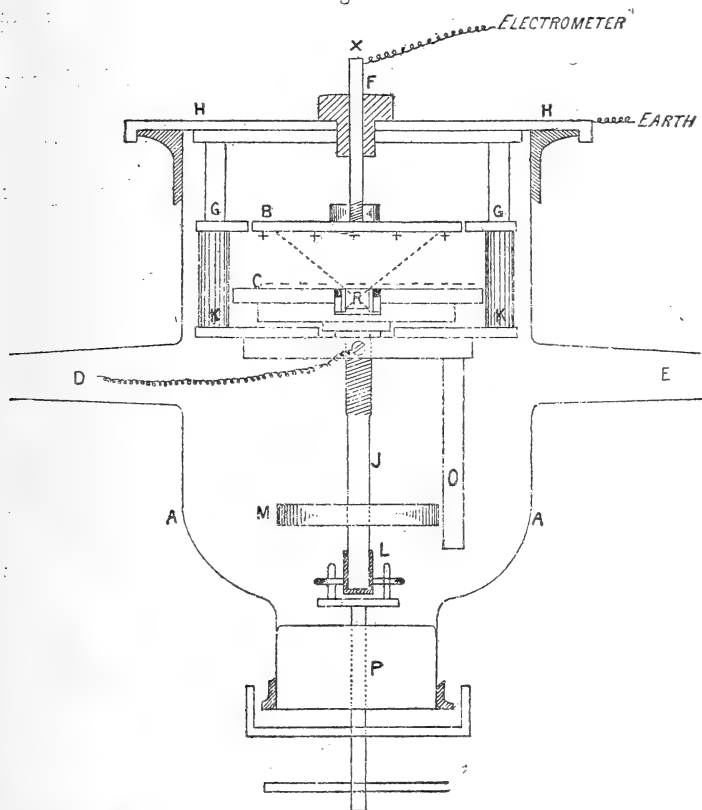

The brass plate C could be raised or lowered by means of a screw J of pitch 1 mm., and was insulated by the ebonite pillars KK and an ebonite extension L. M was a circular ebonite disk divided into ten equal parts so that the distance between the plates could be read on the scale O accurately to more than a tenth of a millimetre. M was turned by a pin passing through the brass plug P, below which was a brass cistern filled with vaseline. This rendered the apparatus perfectly airtight.

The source of alpha radiation was contained in the brass box R let into the plate C and covered with a very thin sheet of aluminium flush with the rest of the plate. At the bottom of R was a plate of copper evenly coated with polonium, and R was made of such a depth and width that every α particle passing through the aluminium would reach the plate B even when the plates were at their greatest distance apart.

The currents were measured by the zero method of Townsend * with a condenser and potentiometer.

The electrometer was enclosed in an earthed lead box and all the connexions were provided with earthed tubes. Throughout the experiments the upper plate B was kept at a positive potential.

In this way every electron formed would reach the plate B, and none would be lost on the guard-ring.

Method of conducting the experiments.

With the larger values of α the formula

$$n = \frac{n_0 (e^{\alpha l} - 1)}{\alpha l}$$

may be used to determine α from the current-E.M.F. curves corresponding to a distance l between the plates. When it is necessary to determine n/n_0 very accurately, it is better to be independent of the quantity n_0 and the values of α may be determined as follows.

It is advisable to take the distances between the plates in the ratio 1, 2, 3, say l , $2l$, $3l$.

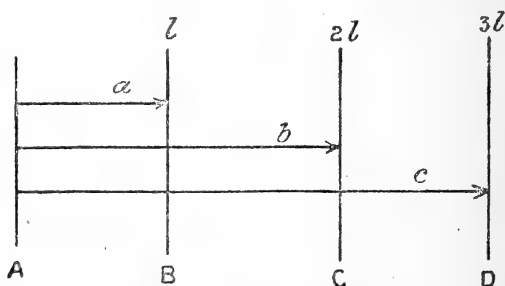

Let the ionization currents observed for these three distances be a , b , c for some particular electromotive force (volts per centimetre).

When the plates are at a distance $3l$ apart the number of electrons generated is c . The number can also be ascertained

* Townsend, Phil. Mag. vi. p. 598 (1903).

by considering the distances AC and CD separately. From observations at distances $2l$ and l , b electrons are generated in AC and a electrons in CD. But the b electrons generate new ones in passing through the extra distance CD, and when they have reached D have increased to the number $be^{\alpha l}$ *.

Hence (1) $c = be^{\alpha l} + a$.

Similarly (2) $c = ae^{2\alpha l} + b$

and (3) $b = ae^{\alpha l} + a$.

The value of α may be found from either of these three equations, two of which are independent.

The results thus obtained for air are given in Table I. and the agreement between the values affords a confirmation of the theory.

The effect of slow moving electrons emitted from the electrodes is automatically eliminated by this method.

$\alpha/p = f(X/p)$ for Air.

The first experiment was to determine the values of α/p for low values of X/p .

A pressure of 9 mm. of mercury was obtained after the vessel had been three times washed out with air thoroughly dried, and exhausted to about a tenth of a millimetre. The distances between the plates were .4, .8 and 1.2 cm. and the electromotive force was taken to give even values of X/p .

Values of X/p from 40 to 100 were thus obtained.

Check results were made at pressures of 6 mm. and 3 mm., and these were found to agree very well with the results obtained for 9 mm.

Results obtained are given in Table I. and the curve is shown in fig. 1 (Pl. XXIV.).

This curve agrees with that obtained by Townsend† in ranges investigated by him, as will be seen from the following table:—

$\frac{X}{p}$	60	70	80	90	100
$\frac{\alpha}{p}$ { Townsend11	.22	.36	.51	.72
Wheatley118	.212	.332	.495	.733

It was found that for values of X/p below 40 it was almost impossible to find the values of α/p when the pressure was as

* Townsend, 'Theory of Ionization by Collision,' § 2.

† Townsend, *ibid.* p 20.

low as 9 mm. The value of α is so small that a very small error in observation would considerably affect the result. Also a 1 per cent. error in the E.M.F. would make an error of about 5 per cent in α .

With a higher pressure low values of X/p may very easily be found, and it is intended to extend the experiments by using large values of X and p in order to see for what range of pressures the formula $\alpha/p = f(X/p)$ is satisfied accurately.

For $X=80$ to 270 the numbers at $\cdot 4$, $\cdot 8$, and $1\cdot 2$ show that the initial ionization is uniform for these distances and almost proportional to the distance, and that the ionizing power of the α particle does not diminish.

TABLE I.
Air. $p = 9$ mm.

X.	·4 cm.	·8 cm.	1·2 cm.	α obtained from equations			Mean Value of α .	α/p .	X/p .
				1.	2.	3.			
80	95	190·7	286·8	9
90	96	192·7	290·0	10
180	97·5	196·8	297·8	20
270	99·4	202·0	308·1	30
360	102·8	212·9	331·0	·174	·173	·171	·173	·019	40
450	109·9	243·9	407·0	·493	·494	·495	·494	·055	50
540	121·1	306·3	589·1	1·060	1·060	1·062	1·061	·118	60
630	143·0	449·8	1107	1·906	1·907	1·908	1·907	·212	70
720	193·5	832·1	2944	2·989	2·987	2·985	2·987	·332	80
810	264·8	1868	11200	4·418	4·452	4·502	4·457	·495	90
900	384·8	5780	81200	6·594	6·610	6·600	6·601	·733	100
Air. $p = 6$ mm.									
80	65·3	130·8	196·5	9
480	104·3	335·6	834·8	1·944	1·958	1·970	1·957	·326	80
Air. $p = 3$ mm.									
80	35·6	71·2	107	9
240	44·3	110·1	207·1	·979	·979	·984	·981	·327	80

If a , b , c be the readings at $\cdot 4$, $\cdot 8$, $1\cdot 2$ cm.
then the three equations are :

$$(1) \quad c = be^{4\alpha} + a.$$

$$(2) \quad c = ae^{8\alpha} + b.$$

$$(3) \quad b = ae^{4\alpha} + a.$$

Experiments with SO₂.

According to Townsend's theory, for any pressure provided it is kept constant, the current-electromotive force curves, corresponding to different distances between the plates, will not cross.

In a paper published in the American Journal of Science, vol. xxxiv. Sept. 1912, on "Ionization by Collision in Gases and Vapours," W. R. Barss claims to have discovered a characteristic difference between the behaviour of gases and vapours at higher pressures. He says: "The curves at the higher pressures in all the vapors employed give evidence of some extraordinary but characteristic behaviour. The curve for a smaller distance between the plates rises more abruptly than for a greater distance; so that the curves for two different distances cross each other. As the pressure is diminished, this process is somehow reversed, the curves becoming approximately parallel and finally diverging as the pressure becomes still further reduced. This is contrary to the behaviour of gases in so far as we have experimental evidence, and is contrary to the facts that would be expected from Townsend's theory.

"The theory of ionization by collision as developed for gases holds for vapors ionized by alpha particles provided the pressure is not too great. As the pressure is increased, evidence of irregularity is obtained which seems to point to some instability in the molecular structure of vapors, either due to the formation of aggregate molecules or to some chemical change."

A series of experiments was made with the apparatus described above in order to test the results obtained by Barss.

The air was pumped out of the vessel to a pressure of one-tenth of a millimetre, and SO₂ vapour (previously dried) was admitted up to atmospheric pressure. The SO₂ used was supplied in a siphon as commercially pure by A. Boake, Roberts & Co., Ltd., Stratford, London. This was again reduced to one-tenth of a millimetre, and again filled with SO₂. The operation was repeated a third time, and then finally the pressure was reduced to 16 mm.

Barss's experiments were reproduced in every particular, pressure 16 mm., distances between plates .5 cm., .8 cm., 1 cm., and field-strengths the same.

The results obtained are given in Table II.

Each of the results is the mean of ten readings taken, and the whole set was taken in three days, so that the decay of the polonium need not be considered.

The values of α have been calculated by the method explained on page 1036 from the readings at .5 and 1 cm.

Fig. 2 (Pl. XXIV.) gives the current-electromotive force curves for SO_2 at this pressure, and it will be seen that there is no tendency for the curves to cross, and that they diverge in the same way as the curves for lower pressures.

Barss's curves for the same pressure, distances, and field-strengths are shown on the same figure by dotted lines.

TABLE II.

SO_2 . Pressure 16 mm.

X.	.5 cm.	.8 cm.	.1 cm.	α .	a/p .	X/p .
50	—	32.37	—			
80	21.02	—	42.07	.0032	.0002	5
100	—	32.57	—			
160	21.28	—	42.65	.0081	.0005	10
200	—	32.87	—			
280	21.50	—	43.21	.0190	.0012	17.5
420	21.57	33.08	43.49	.0307	.0019	26.25
560	21.62	—	43.77	.0479	.0030	35
750	22.41	35.84	—			
800	22.81	36.17	46.76	.0961	.0060	50
845	23.03	—	47.44	.1083	.0068	52.81
1045	26.88	—	56.78	.2133	0.132	65.31
1056	—	43.23	57.31			
1200	32.05	51.85	73.14	.4972	.0311	75
1300	37.81	61.96	102.5	1.0758	.0672	81.25
1400	43.32	77.16	139.1	1.5843	.0990	87.5
1500	50.12	105.2	214	2.3677	.1480	93.75
1600	59.86	155.4				
1700	77.45					
1800	111.2					

In order to further test the result just obtained another experiment was tried with SO_2 at a still higher pressure, viz. 20 mm.

The results are given in Table III. and the corresponding curves in fig. 3.

Here again it will be seen that there is no tendency for the curve for a smaller distance between the plates to rise more abruptly than for a greater distance, and the curves do not cross one another.

There is, therefore, no evidence from these results to show that the behaviour of SO_2 at higher pressures is at all inconsistent with the theory of ionization by collision as developed for gases.

TABLE III.
SO₂. Pressure 20 mm.

X.	.2 cm.	.3 cm.	.4 cm.	α .	α/p .	X/p.
100	11.76	16.90	23.53	.0043	.0002	5
150	11.90					
200	12.18	17.28	24.39	.0112	.0006	10
250	12.20					
300	12.30	17.33	24.66	.0232	.0012	15
350	12.33					
400	12.35	17.45	24.77	.0291	.0015	20
500	12.39	17.53	24.87	.0358	.0018	25
800	12.5	17.82	25.19	.0763	.0038	40
1000	12.78	17.95	25.87	.1209	.0060	50
1400	13.48	20.15	27.98	.3642	.0182	70
1500	13.98	21.20	29.83	.628	.0314	75
1600	14.60	22.83	33.20	1.211	.0605	80
1700	15.50	25.45	37.29	1.703	.0851	85
1800	16.45	28.40	43.40	2.473	.1236	90
1900	18.19	32.55	52.24	3.135	.1568	95
2000	19.50	37.88	64.86	4.218	.2109	100
2100	21.78	44.65	84.85	5.313	.2656	105
2200	24.70	55.82	114.9	6.473	.3236	110
2300	28.75	82.08	161.7	7.652	.3826	115
2400	32.45	106.3	237.9	9.226	.4613	120
2500	38.31	143.7	367.3	10.753	.5376	125
2600	45.85	232.1		15.872	.7936	130
2700	58.30	339.8		17.352	.8676	135
2800	71.28					
2900	91.18					
3000	117.1					
3100	151.4					
3200	202.3					

The experiments differ from those made by Barsr in the manner in which the radioactive matter is distributed.

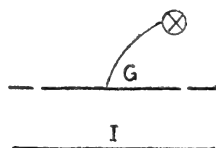

Barsr has a plate G connected with the electrometer and a movable plate I coated with uranium oxide.

$$\alpha/p = f(X/p) \text{ for SO}_2.$$

A further investigation was made to determine the curve connecting α/p and X/p for SO₂, for a large range of values of the ratio X/p .

For this purpose the pressure was reduced to 2·84 mm., and readings were taken with the plates at distances of ·2, ·3, and ·4 cm. apart. The electromotive force was increased in each case until sparking took place. This occurred for ·2 cm. at 2140 volts per cm., for ·3 cm. at 1600 volts per cm., and for ·4 cm. at 1250 volts per cm.

The values of α for ·2 and ·4 cm. were calculated by the method described on page 1036. For ·2 and ·3 cm. a somewhat similar method was adopted as follows.

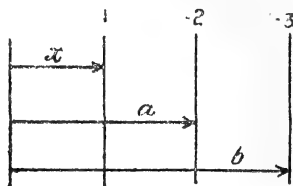

Let a and b be the two observed current readings for distances ·2 and ·3 cm.

Let x be the unknown reading if the plates were ·1 cm. apart. Then we have the following relations:—

$$(1) a = x e^{1\alpha} + x.$$

$$(2) b = a e^{1\alpha} + x.$$

$$(3) b = x e^{2\alpha} + a.$$

By substituting the value of $x = \frac{a}{e^{1\alpha} + 1}$ from equation (1) in equations (2) or (3), we get the following equation for determining α :—

$$(4) a e^{2\alpha} + (a-b) e^{1\alpha} + (a-b) = 0.$$

The values of α , α/p , and X/p are given in Table IV.

Two curves have been drawn for the equation $\alpha/p = f(X/p)$.

4A gives values of X/p up to 528, and 4B up to 90.

In 4B there seems to be a distinct change in the nature of the curve between 65 and 70, and in 1 there is a similar change at about 50. It will be interesting to determine whether this is due to the velocity of agitation of the electrons at low electric forces or not.

TABLE IV.
 SO₂. Pressure 2·84 mm.

X.	·2 cm.	·3 cm.	·4 cm.	α .	a/p .	X/p.
100	1·365	2·396	2·732	·0085	·0030	35·21
150	1·375	2·451	2·755	·0193	·0068	52·81
200	1·469	2·508	2·953	·0517	·0182	70·42
250	1·563	2·633	3·237	·3417	·1203	88·02
300	1·687	2·875	3·657	·7756	·2731	105·63
350	1·865	3·198	4·349	1·4336	·5048	123·23
400	2·052	3·677	5·594	2·734	·963	140·84
450	2·302	4·313	7·063	3·550	1·25	158·44
500	2·646	5·213	9·500	4·762	1·68	176·05
550	3·094	6·354	13·25	5·938	2·09	193·65
600	3·625	8·113	18·50	7·067	2·43	211·26
650	4·091	10·53	24·55	8·047	2·77	228·86
700	4·819	13·03	32·87	8·815	3·10	246·47
750	5·656	16·9	49·37	10·226	3·60	264·07
800	6·625	21·06	70·04	11·293	3·98	281·68
850	7·729	27·75	104·1	12·613	4·44	299·28
900	9·125	35·3	150·1	13·685	4·82	316·89
950	10·62	45·73	212·8	14·729	5·19	334·49
1000	12·16	58·99	307·9	15·955	5·62	352·10
1050	14·22	76·56	481·4	17·619	6·19	369·70
1100	16·55	97·80	694·9	18·566	6·54	387·31
1150	19·25	130·8	925	19·256	6·78	404·91
1200	21·81	162·4	1500	21·080	7·42	422·52
1250	24·89	209·2	Sparking	21·163	7·45	440·12
1300	29·31	263·2	...	21·861	7·70	457·73
1350	33·8	362·1	...	23·598	8·31	475·33
1400	39·2	460·6	...	24·588	8·66	492·94
1450	44·92	599·7	...	25·872	9·11	510·54
1500	50·94	802·9	...	27·468	9·67	528·15
1600	70·49	Sparking				
1700	94·92					
1800	125·4					
1900	168·4					
2000	247·9					
2100	411·8					
2130	502·3					
2140	Sparking					

In conclusion I would like to express my best thanks to Professor Townsend for the valuable encouragement and advice given me during the work.

Lincoln College, Oxford,
 October 1913.

XCV. *Structure of the Atom.**To the Editors of the Philosophical Magazine.*

DEAR SIRS,

In my paper on the Structure of the Atom (Phil. Mag. Oct. 1913) I supposed that the regions within which the electrical forces inside the atom were supposed to be confined were bounded by conical surfaces. I find on further investigation that with such surfaces the period of a corpuscle inside the region would increase as its energy increased, and the corpuscle would cease to be in unison with the light before it had acquired enough energy to escape from the region of electrical force. If, however, the boundaries of these regions are cylindrical instead of conical, the period will be independent of the kinetic energy of the corpuscle, and the latter will be in resonance with the light until it has acquired enough energy to escape from the region; assuming cylindrical instead of conical boundaries, the results given in the paper can apply without further modification.

Yours very truly,

J. J. THOMSON.

Cambridge, Nov 8, 1913.

XCVI. *The Electrical Resistance of Mixtures of Xylol and Alcohol.* By NORMAN CAMPBELL, *Sc.D.**

1. **S**OME further experiments have been made on the high resistances consisting of mixtures of xylol and ethyl alcohol in glass tubes to which reference has been made in previous papers †. The investigation was undertaken mainly with the object of obtaining information bearing on their use in practice, but at the outset a point of theoretical interest was determined. It is to be expected that the mechanism of conduction in such a mixture should be similar to that in an electrolyte, but the previous experiments had shown that the conductivity of the mixtures differed from that of electrolytes in two particulars. First, the conductivity decreased with the temperature, like that of a metal; second, it appeared to be unaccompanied by polarization.

However, a little consideration shows that the second and most remarkable feature does not indicate that the conduction is not electrolytic; polarization does not appear simply because

* Communicated by the Author.

† Campbell, Proc. Camb. Phil. Soc. xv. p. 322 (1900); Phil. Mag. Aug. 1911, p. 301, and April 1912, p. 668.

the conductivity of the mixtures is so low that the current which can be passed through them by a P.D. comparable with the back E.M.F. does not liberate in the time of the experiment enough hydrogen to cover the electrode with a layer one molecule thick. All the mixtures investigated in these experiments have been contained in cells of such a form that the total resistance was greater than 10^8 ohm. Accordingly a P.D. of 1 volt, comparable with the expected value of the back E.M.F., would only liberate 6×10^{10} atoms per second; in order to cover the electrodes (area about 1 cm.^2) with a single layer of these atoms the current would have to pass for more than a day. It was found that if distilled water were contained in a cell consisting of a metre of the finest bore thermometer tubing, so that its total resistance was about 10^9 ohms, the current through it appeared to obey Ohm's law as perfectly as that through the xylol-alcohol mixtures which have been investigated.

Accordingly the only reason which remained for supposing that the current in the mixtures was not carried by electrolytic ions, and that the mechanism of the conduction was not the same as that in all other non-metallic liquids, was the sign of the temperature coefficient of the conductivity. The anomalous sign, though interesting, did not seem to suggest that theoretically important results would be obtained by a thorough investigation of the phenomenon, and accordingly the experiments were confined to those which would lead to results of immediate practical importance.

2. It is desirable to describe in some detail the arrangements which were found most suitable for the construction and measurement of the resistances.

The mixtures were contained in glass cells with platinum electrodes of one of the types shown in fig. 1. The cells were placed in a thermostat, the water of which, being earthed, provided electrostatic shielding. (Such shielding is scarcely necessary if the resistance of the cell is less than 10^9 ohms.) The coating of sealing-wax is intended to increase the resistance of the empty cell; the conductivity of the empty cell was always less than 10^{-15} mho, and could always be neglected in comparison with that of the mixture which was not less than 10^{-12} mho. Which form of cell was adopted depended simply on the relation between the conductivity of the mixture and the magnitude of the resistance desired; otherwise there appeared no advantage in using a cell in which the electrodes were near together rather than one in which they are far apart. The "conductivity constants" of the cells were determined in the usual manner by the use

of standard electrolytes of known conductivity and a Kohlrausch bridge.

Fig. 1.

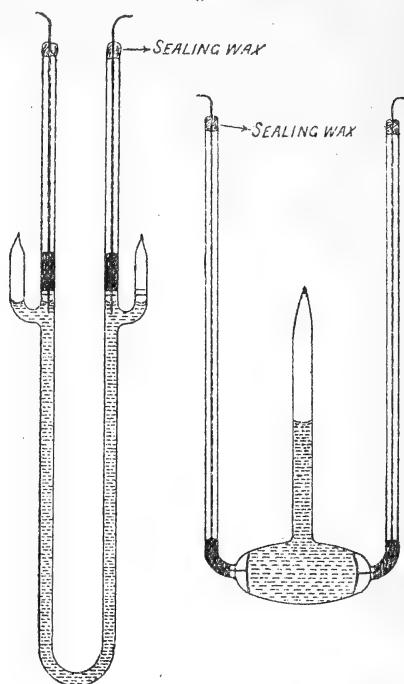

The resistances of the cells, which in these measurements always lay between 10^{12} and 10^8 ohm, are most conveniently determined by comparison with a known resistance. The primary known resistance used was a wire megohm; secondary standards were provided by xylol-alcohol resistances which have been long in use and were kept constantly in melting ice. The secondary standards had been carefully compared with each other and, in the case of the lowest, with the wire megohm; their resistances were very approximately 10^{11} , 10^{10} , and 10^9 ohms.

When the ratio of the unknown resistance (x) and the known (R) is not greater than 20, the comparison may be conveniently effected by means of an ordinary Wheatstone bridge in which the ordinary galvanometer is replaced by an electrometer (1500 divs. per volt). The scheme of

connexions is shown in fig. 2. The resistances r_1, r_2 , are taken from a Post Office box, the greater of them being always

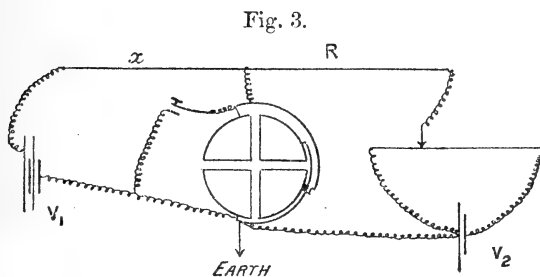
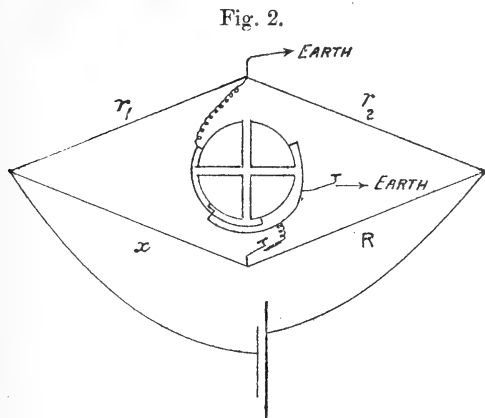

2000 ohms. When the ratio x/R is greater than 20 the arrangement shown in fig. 3 is more sensitive; the potential of the battery V_1 may be 100 volts or more and compared with that of V_2 (2 volts) by means of a standard voltmeter. These methods of comparison are certainly more accurate than those based on the use of a constant current provided by a radioactive preparation, because when two of the resistances investigated are balanced against each other there are no observable "Schweidler's fluctuations." In fig. 2 the fulfilment of Ohm's law is easily tested by changing the E.M.F. of the battery.

It was usually found that the bridge was not completely balanced even when the battery switch was open and, consequently, that the values of r_1, r_2 necessary to obtain a balance varied with the direction of the current. I think it is this

observation which has led some experimenters to imagine that these liquid resistances show polarization. As a matter of fact this "zero E.M.F." has nothing to do with the mixture in the cell; it arises from a P.D. between the external electrode of the cell which is connected to the electrometer and the "earthed" surroundings; it is very much less when care is taken to obtain good insulation between that electrode and its surroundings by means of the sealing-wax (fig. 1). Even if this zero E.M.F. is (as it may be in bad cases) comparable with 1 volt, it need not vitiate the measurements of resistance by means of the bridge. If r_1' , r_2' are the values of r_1 , r_2 necessary for a balance when the current flows in one direction, r_1'' , r_2'' those when it flows in the other, then

$$\frac{x}{x+R} = \frac{1}{2} \left(\frac{r_1'}{r_1' + r_2'} + \frac{r_1''}{r_1'' + r_2''} \right).$$

It was also found that it was usually impossible to balance the bridge permanently and exactly; the position of balance varied slightly with the time which had elapsed since the battery circuit was closed or reversed. The ratio of the resistances measured 2 minutes after reversal was about 2 or 3 parts in a 1000 different from that measured 10 minutes after reversal, the change being in such a direction that the resistances tended to become more nearly equal with lapse of time. This drift of the position of the balance was traced almost certainly to induction effects in the glass of the cells or other insulator surrounding the conductor; it could just be detected even when two wire-resistances were compared. If readings were always taken at the same interval after reversal perfect consistency was obtained and the measured ratio of the resistances was wholly independent of the E.M.F. of the battery. The values given are in all cases those 3 minutes after reversal.

3. Experiments were made first on the variation of the conductivity of the mixtures with their composition, the temperature being in all cases $25^{\circ}6$. The xylol and alcohol used in preparing the mixtures had been each twice redistilled from calcium; the same specimens were used in preparing all these mixtures. The following table gives the specific conductivity (γ) for various values of y , where y is the ratio of the weight of the alcohol to the total weight of the mixture; $y=1$ corresponds to pure alcohol, $y=0$ to pure xylol. It will be observed that the conductivity varies extremely rapidly with y , the variation being the more rapid the smaller the value of y , and that the conductivity

of the mixture is always less than that calculated by an additive law from the proportions and conductivities of the constituents.

TABLE I.

y .	γ (mhos. cm.)	y .	γ (mhos. cm.)
1.000	6.95×10^{-6}	0.09	8.50×10^{-10}
0.25	4.47×10^{-7}	0.08	3.76×10^{-10}
0.20	1.00×10^{-7}	0.07	1.60×10^{-10}
0.18	5.31×10^{-8}	0.06	5.92×10^{-11}
0.16	2.81×10^{-8}	0.05	2.12×10^{-11}
0.14	1.44×10^{-8}	0.04	7.08×10^{-12}
0.12	5.77×10^{-9}	0.00	$< 10^{-15}$
0.10	1.68×10^{-9}		

Usually after the mixture has been introduced into the cell its resistance changes for the first 3 or 4 days; the change is usually an increase in resistance, but in some cases the resistance decreased; the greatest change observed was 40 per cent. If the mixture is prepared a week before it is put in the cell and stored in a sealed vessel, its resistance still changes after it is put in the cell. Mixtures for which y is about 0.12 suffer very little change of resistance and are, therefore, specially suitable for the preparation of resistances. The conductivities given in the table are those observed immediately after filling; it was too tedious to wait until the resistance became constant; but, since γ varies so rapidly with y , the form of the relation between γ and y would be little changed if the final conductivities were substituted.

Some observations were made on the effect of impurities in the alcohol or the xylol. Water is, of course, the impurity which is of most importance. If the xylol was shaken up with water and then separated from it, the specific conductivity remained less than 10^{-15} mho. cm. and no difference in the conductivity of the mixtures prepared from it could be detected. Water, therefore, is an impurity of no importance so far as the xylol is concerned. Several specimens of alcohol were examined; one of these was commercial "absolute alcohol," the others prepared from this specimen by one or more distillations from lime or calcium. The specific conductivities of these specimens varied from

6.95×10^{-6} to 9.6×10^{-6} mho. cm. and the conductivities of the mixtures prepared from them increased with the conductivities of the alcohols. But no relation could be traced between the conductivity of the alcohol and the "purification" which it had undergone; the specimen with the highest conductivity had been twice distilled from calcium, while the original sample had a conductivity little greater than that of the least conducting*. The effect of adding 2 per cent. of water to the least conducting alcohol was tried. The conductivity of the alcohol itself was apparently unaffected by the presence of the water; such a result is to be expected, for the conductivities of the alcohol and the distilled water used were nearly equal; but the mixtures prepared from the wet alcohol were more conducting than those prepared from the dry. In the case of a mixture for which $y=0.12$ the increase in conductivity was 45 per cent.

It must be remembered that, whether the mixture were "wet" or "dry," prepared from pure or impure alcohol, the current through them obeyed Ohm's law equally well, so long as the total resistance of the cell containing the mixture was greater than 10^8 ohms. There appears then to be no special advantage in taking elaborate precautions to purify the alcohol used; ordinary commercial absolute alcohol will serve as well as any other.

4. Experiments were also made on the temperature coefficient of the conductivity of the mixtures. In one of the previous papers it was stated that the variation of the conductivity with the temperature was irregular between 15° and 10° . This observation has not been confirmed: a perfectly definite value for the temperature coefficient could be obtained at all temperatures between 0° and 30° . The temperature coefficient varies with the temperature, the relation between the conductivity and the temperature being expressible between 0° and 30° by a formula of the form

$$\gamma = \gamma_0(1 + at + bt^2).$$

For mixtures of xylol and alcohol for which y is less than 0.25 both a and b are negative and b/a is of the order of 0.008. For alcohol unmixed with xylol a is positive and b very small

* Dr. Dawson, to whom I am indebted for much help in these experiments, informs me that it is now believed that distillation from calcium does not always result in a purification of the alcohol. The water may be removed, but other impurities, due to the action of the calcium on the alcohol, may be introduced. I was unaware of this fact until the experiments were completed.

and negative. The "temperature coefficients" given below are in all cases those corresponding to $t=15^{\circ}$, i. e. $\left(\frac{1}{\gamma} \frac{d\gamma}{dt}\right)_{15}$.

The temperature coefficient of the various specimens of alcohol was as variable as their conductivity. The largest coefficient observed with "dry" alcohol was $0+0\cdot010$; the smallest (obtained with the specimen from which the mixtures of Table I. were prepared) was $+0\cdot0027$. The addition of water to the alcohol increases the temperature coefficient, as might be expected from the fact that the temperature coefficient of water is greater than that of alcohol.

The following determinations were made of the temperature coefficients of the mixtures mentioned in Table I.

TABLE II.

y .	γ .	$\left(\frac{1}{\gamma} \frac{d\gamma}{dt}\right)_{15}$
0.25	4.47×10^{-7}	-0.0117
0.102	1.95×10^{-9}	-0.0168
0.055	4.09×10^{-11}	-0.0124

The probable error of these determinations of the temperature coefficient is about 0.001. It may be concluded therefore that the temperature coefficient is a maximum for a mixture for which y is about 0.12. If the mixtures are prepared with wet alcohol instead of dry the temperature coefficients appear to be slightly greater, but the difference did not exceed the probable error. The temperature coefficient for a mixture appears to be quite constant while its conductivity changes.

It will be observed that, since the coefficient of alcohol is positive and that of the mixtures negative, there should be some mixture for which the coefficient is zero. Attempts were made to discover the composition of such a mixture, but it was found that its composition varied so much with the specimen of alcohol used that it was difficult to define the composition accurately. A mixture for which $y=0.6$ has approximately a zero temperature coefficient; the specific conductivity of such a mixture is so great that it is not convenient to use in the preparation of resistances of more than 10^9 ohms.

The conductivity of the xylol was too small to be measured

by the methods here adopted, and no determinations of its temperature coefficient were made.

5. As has been said, all these observations were made with the object of obtaining information valuable for the construction of resistances. It would be convenient if precise information could be given as to the specific conductivity and temperature coefficient of mixtures of various concentrations so that a cell of known "conductivity constant" could be filled with a mixture so as to give an accurately known resistance. And perhaps by very careful investigation of the properties of alcohol prepared in various ways, a specification for the preparation of resistances of accurately known properties could be given. But it appears that the properties of the mixtures depend so greatly on small changes in the properties of the alcohol, that it would be much more trouble to prepare a specimen of alcohol according to the specification than to measure the resistance of a cell when it had been constructed. Accordingly I am of the opinion that the easiest way to prepare a known resistance is to make the mixture out of commercial alcohol and xylol and then to measure its resistance and temperature coefficient. If a resistance of a definite number of ohms is required, the conductivity constant of the cell can be estimated from its dimensions; it can then be filled with a mixture of such conductivity (taken from Table I.) that the cell will have the desired resistance. In this way a cell can easily be prepared with a resistance which does not differ from that desired by a factor of 3. If a closer adjustment is required, another mixture having the desired conductivity can be prepared from the same alcohol from the information contained in Table I. There is some advantage in constructing the cell so that the mixture which is required to fill it is that for which $y=0.12$; for the resistances of such mixtures do not change much after preparation. It is true that such mixtures have a very large temperature coefficient, but in any case it will be necessary to measure that coefficient if very accurate work is contemplated. If an accuracy of $\frac{1}{2}$ per cent. while the temperature of the cell varies 3° is sufficient, the temperature coefficient of the conductivity of such a mixture at 15° may be taken to be -0.017 .

The best way to determine the absolute value of the resistance is to compare it with that of a wire megohm. If a resistance of about 10^9 ohms is constructed and an accurate voltmeter is available, such a resistance can be compared with an accuracy of $\frac{1}{2}$ per cent. with any resistance between 10^6 and 10^{12} ohms by means of the method shown in fig. 3. When it is desired to measure very small currents there seems to be no advantage in choosing a resistance of

more than 3×10^{11} ohms; with such a resistance a change in the current of 3×10^{-15} amp. can be certainly detected. If a higher resistance is taken the conductivity of the insulation of the apparatus is apt to be comparable with that of the resistance, and if, as is usually the case, the currents measured are those due to radioactive rays, Schweidler's fluctuations prevent any increase in the accuracy of the measurement*.

In conclusion it may be pointed out that these high resistances appear to provide the most convenient means of determining small currents of 10^{-10} amp. or less in absolute measure. They are both cheaper and easier to use than either standard capacities or quartz piezoelectrics. Perhaps some instrument-maker will undertake the construction of such standardized high resistances.

Summary.

Some further information is given as to the high resistances made of mixtures of xylol and alcohol contained in glass cells. The conclusions important for the practical construction of such resistances are given in § 5.

Leeds University, Oct. 1913.

XCVII. *On the Highest Wave in Deep Water.* By J. R. WILTON, M.A., B.Sc., Assistant Lecturer in Mathematics in the University of Sheffield †.

IT is possible to obtain a fluid motion in two dimensions with any given curve as free surface. (The "motion" spoken of in this paper is, throughout, to be understood to mean steady motion.)

Let the axis of x be horizontal, that of y vertically upwards.

$$\text{Let} \quad z = x + iy, \quad w = \phi + i\psi,$$

* It seems that some persons who have used such resistances (and also Bronson resistances) for the measurement of currents have estimated the current by earthing that end of the resistance which is not attached to the quadrant of the electrometer and observing to what potential the quadrant rises. A far more convenient, accurate, and rapid method is to connect that end of the resistance to a potentiometer and to observe to what potential that end must be raised in order that the electrometer-needle should not move when the quadrant is insulated disconnected from earth. The rapidity of the measurements is then independent of the time which the needle of the electrometer takes to come to rest. This method would appear specially suitable for observations of radioactive substances with a short period of decay. It must be noted that if, as usually happens, there is a small "zero E.M.F." (p. 1048), its effects can be eliminated, either by subtracting it from the potentiometer readings or, more conveniently, by changing the sign of the current. The zero E.M.F. will be found to be wonderfully constant over days.

† Communicated by the Author.

where ϕ and ψ are the velocity potential and the stream function, respectively.

Then the motion for which the free surface is given by eliminating θ between $x=X(\theta)$, $y=Y(\theta)$ is represented by the equations,

$$\left. \begin{aligned} z &= X(\theta) + \iota Y(\theta), \\ w &= \int \sqrt{[C - 2gY(\theta)](X'^2 + Y'^2)} d\theta, \end{aligned} \right\}, \quad \dots \quad (1)$$

where θ is a complex variable, X and Y are functions of θ which are real when θ is real, and X' and Y' denote respectively $\frac{dX}{d\theta}$ and $\frac{dY}{d\theta}$.

For the condition to be satisfied on the free surface, $\psi=0$, is

$$q^2 = C - 2gy,$$

where q is the resultant velocity, *i. e.*

$$q^2 = \left| \frac{dw}{dz} \right|^2 = \left| (C - 2gY)(X'^2 + Y'^2) \left(\frac{d\theta}{dz} \right)^2 \right|.$$

But $\psi=0$ if θ is real (provided $C - 2gY$ is positive),

$$\begin{aligned} i. e. \quad q^2 &= \left| (C - 2gY) \frac{X' - \iota Y'}{X' + \iota Y'} \right| = C - 2gY \\ &= C - 2gy, \end{aligned}$$

for on the surface, since θ is real,

$$x = X(\theta), \quad y = Y(\theta).$$

The equation of the free surface may thus be chosen arbitrarily. But the converse problem of determining the form of the free surface when some other condition is given can only be attacked by tentative methods.

It will be convenient for our purpose to put $\theta = F(w)$, and $Y(\theta) = \theta$. This does not in any way limit the generality of the result. We then have

$$z = \int \sqrt{\frac{1}{C - 2gF(w)} - [F'(w)]^2} dw + \iota F(w),$$

and the equation of the free surface is

$$\begin{aligned} y &= F(\phi), \\ x &= \int \sqrt{\frac{1}{C - 2gF(\phi)} - [F'(\phi)]^2} d\phi \\ &= \int \sqrt{\frac{1}{(C - 2gy) \left(\frac{dy}{d\phi} \right)^2} - 1} dy. \end{aligned}$$

The function $F(\phi)$ must be real. There must also be a limit to the form of F owing to the fact that x must be real.

If we suppose that the depth of the fluid is infinite, the condition to be satisfied is

$$\frac{dz}{dw} = \frac{1}{c}, \quad \text{when } \psi = -\infty.$$

A function satisfying these conditions is that given by the equation

$$\frac{gw}{c^3} = \sin^{-1} \sqrt{\frac{2gF}{c^2}} + \sqrt{\frac{2gF}{c^2} \left(1 - \frac{2gF}{c^2}\right)},$$

for which

$$z = \sqrt{F \left(\frac{2c^2}{g} - F \right)} + \frac{2c^2}{g} \sin^{-1} \sqrt{\frac{gF}{2c^2}} + \iota F,$$

where in applying equation (1) we have put $C=c^2$; and the equation of the free surface is

$$x = \sqrt{y \left(\frac{2c^2}{g} - y \right)} + \frac{2c^2}{g} \sin^{-1} \sqrt{\frac{gy}{2c^2}}. \quad \dots (2)$$

Since $y=F$, and has to be real, the greatest value of y is $c^2/2g$, and the least is 0. Therefore the amplitude of the wave is $c^2/2g$, which is the value of y at the crest.

The wave-length is

$$\begin{aligned} \lambda &= 2 \left[\sqrt{y \left(\frac{2c^2}{g} - y \right)} + \frac{2c^2}{g} \sin^{-1} \sqrt{\frac{gy}{2c^2}} \right]_{0}^{c^2/2g} \\ &= 2 \frac{c^2}{2g} \left(\sqrt{3} + \frac{2\pi}{3} \right) \\ &= \left(2\sqrt{3} + \frac{4\pi}{3} \right) a \\ &= 7.6 a, \text{ nearly,} \end{aligned}$$

where a is the amplitude

The velocity is given by

$$\frac{2\pi c^2}{g\lambda} = \frac{4\pi a}{\lambda} = \frac{3}{1 + \frac{3\sqrt{3}}{2\pi}} = 1.64.$$

At the crest, where $y = \frac{c^2}{2g}$, we find

$$\frac{dx}{dy} = \pm \sqrt{3},$$

so that there is a sharp angle of 120° in the wave-profile at this point.

This result is in agreement with the work of Stokes and of Michell on the "highest wave" in water. The ratio of wave-length to amplitude is also in fair agreement with the approximate value given by Michell*, but the velocity is considerably greater. He gives

$$a/\lambda = .142, \quad \text{or} \quad \lambda = 7.04 a;$$

and
$$c^2 = .191 g\lambda, \quad \text{or} \quad \frac{2\pi c^2}{g\lambda} = 1.20.$$

Michell's series appear to converge fairly rapidly, but the addition of terms of higher order would certainly tend to increase his estimate of the velocity.

The wave-profile evidently consists of a succession of arcs of cycloids which meet one another at an angle of 120° . If

we put $y = \frac{2c^2}{g} \sin^2 \frac{\theta}{2}$, the equation of the free surface takes the form

$$\left. \begin{aligned} x &= \frac{c^2}{g} (\theta + \sin \theta) \\ y &= \frac{c^2}{g} (1 - \cos \theta) \end{aligned} \right\}, \dots \dots \dots (3)$$

where the whole wave-length is included between $\theta = -\pi/3$ and $\theta = \pi/3$. Certain easily determinable constants of integration must be added to the expression for x in the various cases when θ has any other of its possible ranges of values

on the free surface:—*e. g.* when $\frac{5\pi}{3} < \theta < \frac{7\pi}{3}$ the constant is $\frac{c^2}{g} \left(\frac{4\pi}{3} - \sqrt{3} \right)$.

We may verify this result by determining the steady motion for which equations (3) represent a free surface. It will be given by

$$\begin{aligned} z &= \frac{c^2}{g} [\theta + \sin \theta + \iota(1 - \cos \theta)], \\ w &= \frac{c^2}{g} \int \sqrt{[c^2 - 2c^2(1 - \cos \theta)]2(1 + \cos \theta)} d\theta, \\ &= \frac{2c^3}{g} \int \sqrt{2 \cos \theta - 1} \cos \frac{\theta}{2} d\theta; \end{aligned}$$

whence

$$\frac{gw}{2c^3} = \sin \frac{\theta}{2} \sqrt{1 - 4 \sin^2 \frac{\theta}{2}} + \frac{1}{2} \sin^{-1} \left(2 \sin \frac{\theta}{2} \right).$$

* Phil. Mag. November 1893.

We may write the equation for z in the form

$$\frac{gz}{c^2} = \theta + i - i e^{i\theta}.$$

Then

$$\begin{aligned} \frac{dw}{dz} &= \frac{2c^3}{g} \sqrt{2 \cos \theta - 1} \cos \frac{\theta}{2} \frac{d\theta}{dz} \\ &= c \sqrt{1 - e^{-i\theta} + e^{-2i\theta}}. \end{aligned}$$

This gives

$$q^2 = \left| \frac{dw}{dz} \right|^2 = c^2(2 \cos \theta - 1), \text{ when } \theta \text{ is real,}$$

i. e. $q^2 = c^2 - 2gy$ on the surface.

Further, the bottom of the liquid corresponds to $\theta = -i\infty$ ($y = -\infty$, $\psi = -\infty$), which makes

$$\frac{dw}{dz} = c,$$

as it should be.

Hence equations (3), where it is understood that

$$\frac{1}{2} < \cos \theta < 1,$$

and that, when θ does not lie between $\frac{-1}{3}$ and $\frac{1}{3}$, the appropriate constant is to be added to x in order to make the arcs of the various cycloids "fit on," represent a possible form of the "highest wave" in deep water.

The necessity of "fitting on" the different arcs of the cycloid leads to a difficulty which cannot satisfactorily be overcome. There is a discontinuity in the motion across the vertical lines through the crests of the wave, for the vertical velocity does not vanish on these lines, except at the crest of the wave and at the bottom of the fluid; and, moreover, its direction, but not its magnitude, is changed in passing across these lines. This necessitates a constant change of momentum in passing across these lines, which change, it will be seen, is vertically *upwards*, so that it can be supplied, and the above equations will therefore represent an exact solution of the problem, if we suppose that the bottom of the fluid is a rigid horizontal plane.

The solution is, however, more interesting when regarded as an approximation to the actual physical solution of the problem of determining the form of the highest wave in deep water. That it can be so regarded is due to the fact that along the vertical lines through the crests v is small.

I find, for $x = \frac{c^2}{g} \left(\frac{\pi}{3} + \frac{\sqrt{3}}{2} \right)$, the following table connecting u and v with y :—

$\frac{gy}{c^2}$	$\frac{u}{c}$	$\frac{v}{c}$
$-\infty$	1	0
-4.82	.912	-.024
-2.43	.869	-.039
-.59	.747	-.034
-.18	.658	-.023
+.18	.505	-.010
+.5	0	0

The negative sign shows that the direction of v is downward.

XCVIII. *Intelligence and Miscellaneous Articles.*

ON THE EXISTENCE OF URANIUM Y.

To the Editors of the Philosophical Magazine.

GENTLEMEN,—

TWO years ago I gave an account in this Journal (Phil. Mag. xxii. p. 419, 1911) of experiments which indicated the presence of a new product in uranium of half period of transformation 1.5 days, which I called uranium Y. Evidence was given that this new radioactive substance must be regarded as a branch product of the main uranium series. In the May number of this Journal Mr. A. Fleck described some experiments in which he was unable to separate this new product, and concluded that the results obtained by me were possibly to be ascribed not to a new product but to the presence of thorium in my uranium preparations. In my reply (Phil. Mag. Aug. 1913) I gave reasons for doubting the correctness of Mr. Fleck's conclusions, and expressed the view that it was impossible to explain my results by the presence of thorium products, as the radioactive constants of uranium Y were quite different from those to be expected for the products of thorium.

In his experiments Mr. Fleck employed a highly purified uranium salt which had been prepared some years before by Mr. F. Soddy, F.R.S. It seems possible that the inability of Mr. Fleck to find evidence of uranium Y might be due to the removal of its parent substance in the methods of purification. In order to throw light on this point, Mr. Soddy kindly loaned to me about 60 grammes of his pure uranium nitrate. I repeated my original experiments with this material, and was at once able to separate uranium Y from it.

Since Mr. Fleck was unable to repeat my work, I am intending to publish shortly a paper giving a more detailed account of my experimental methods. I trust that other investigators will then find no difficulty in repeating my original experiments.

I am at present making further investigations to determine more accurately the ratios of the activities of uranium X and uranium Y, comparing the penetrating rays of uranium X with the most penetrating rays from uranium Y. I have found that the activity of the latter must be more than 2 per cent. of the former. This ratio is of the order of magnitude to be expected if the actinium series branched off at this point.

G. N. ANTONOFF.

Chemical Laboratory of the Academy of Sciences,
St. Petersburg.

m.

FIG. 7.—Analysis of γ radiation from radioactinium.

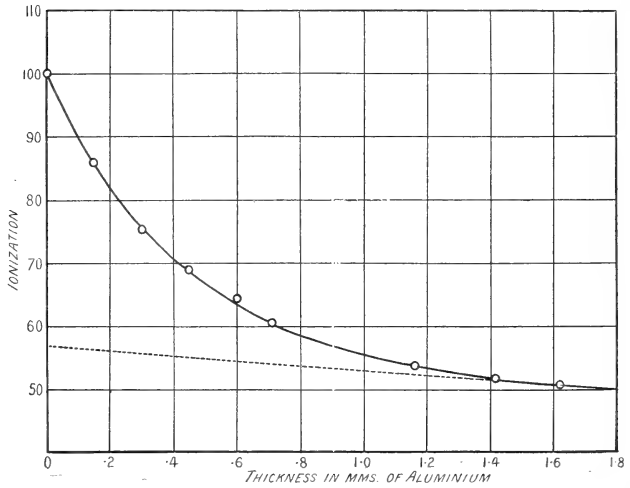

n.

FIG. 8.—Penetrating γ radiation from radioactinium.

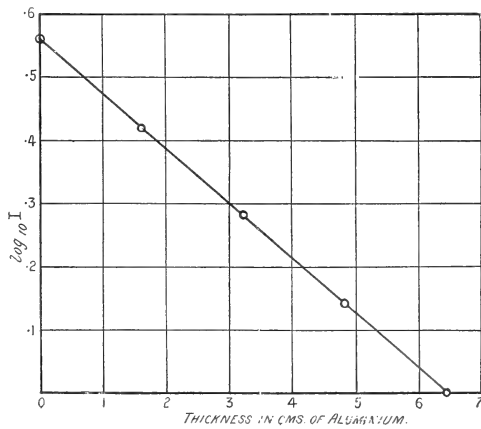



FIG. 1.—Analysis of radiations from active deposit of thorium.

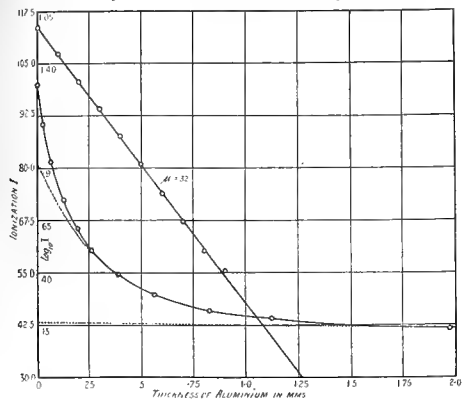

FIG. 3.—Analysis of γ radiation from mesothorium 2.

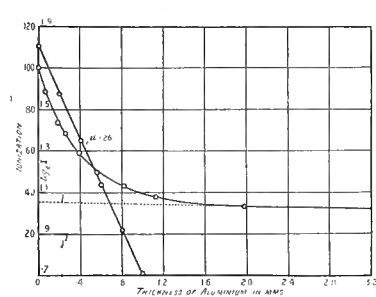

FIG. 5.—Analysis of γ radiations from active deposit of actinium.

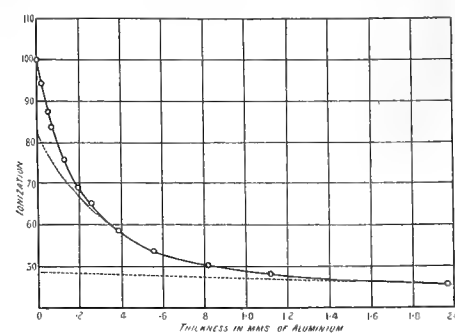

FIG. 7.—Analysis of γ radiation from radioactinium.

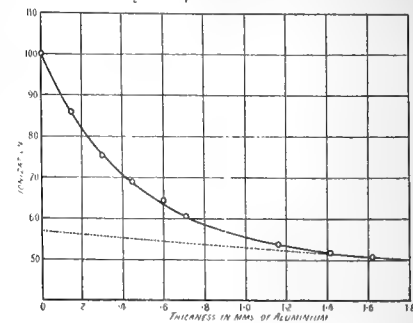

FIG. 2.—Analysis of γ rays from active deposit of thorium.

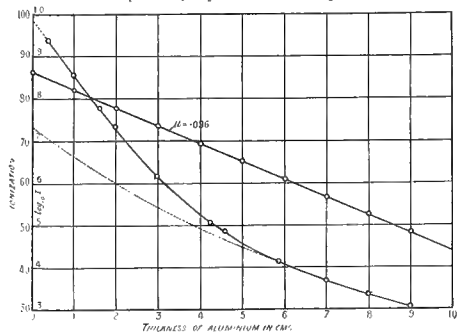

FIG. 4.—Penetrating γ radiation from mesothorium 2.

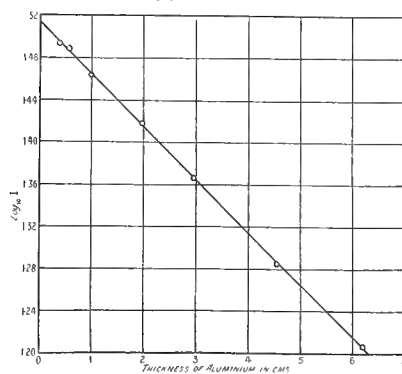

FIG. 6.—Analysis of γ radiation from active deposit of actinium.

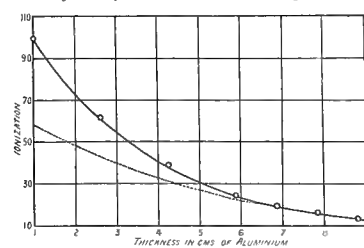
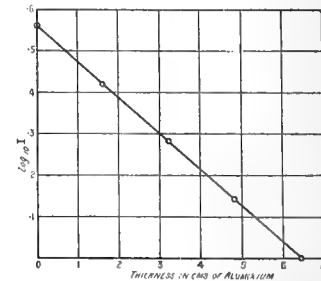
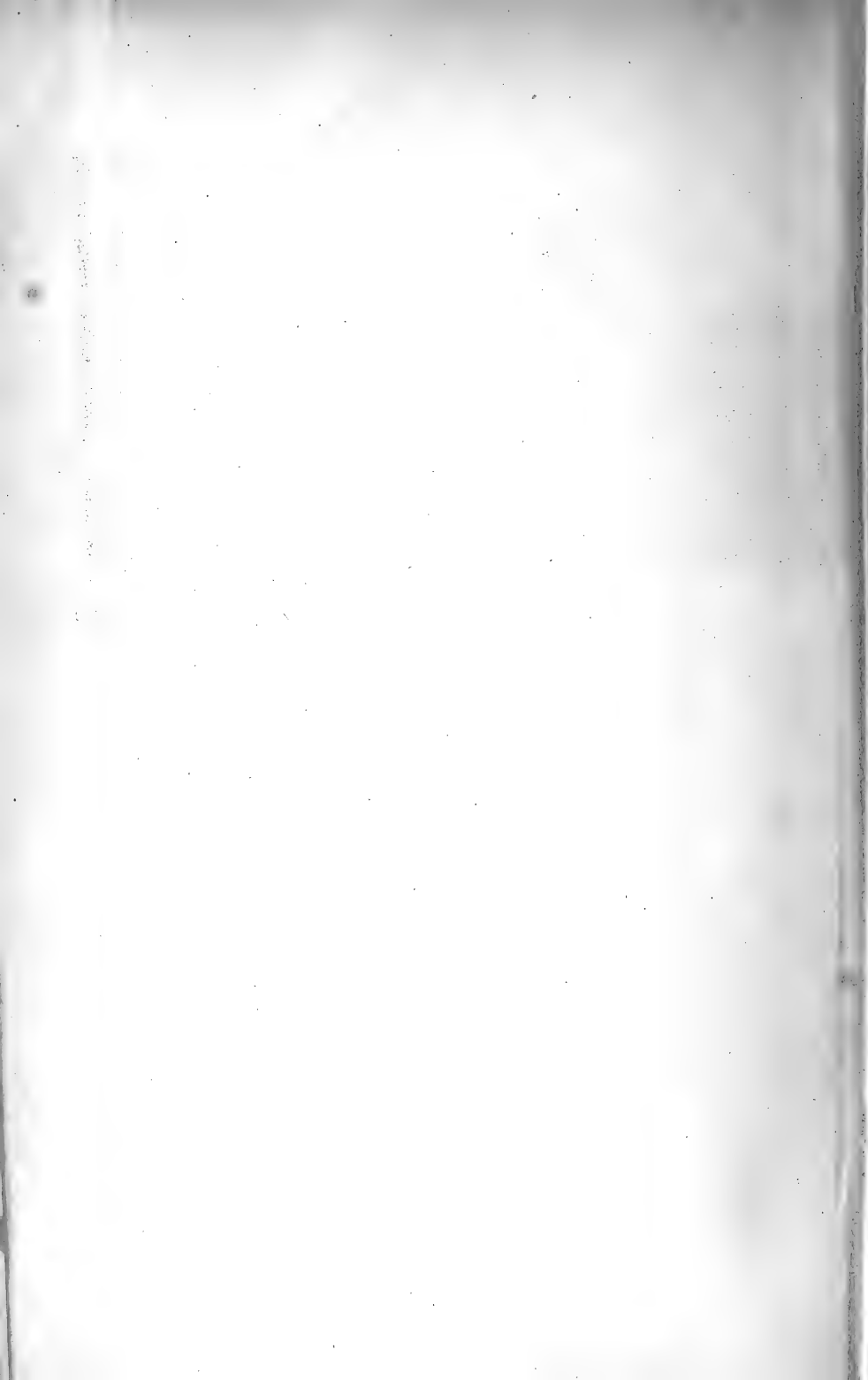

FIG. 8.—Penetrating γ radiation from radioactinium.





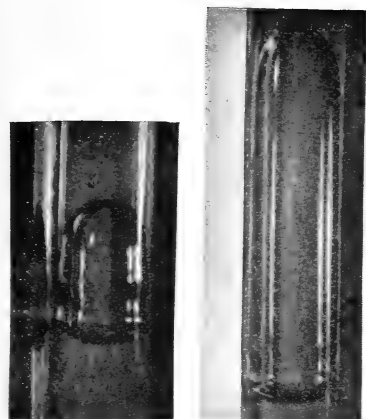

FIG. 1.—Tube diameter .788 cm.

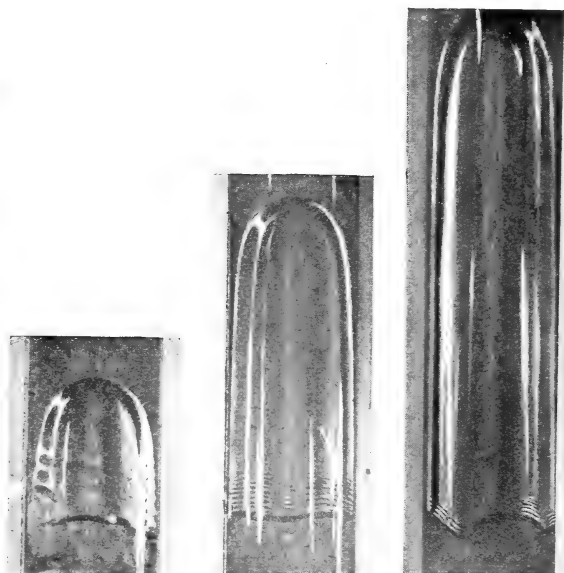

FIG. 2.—Tube diameter 1.680 cm.

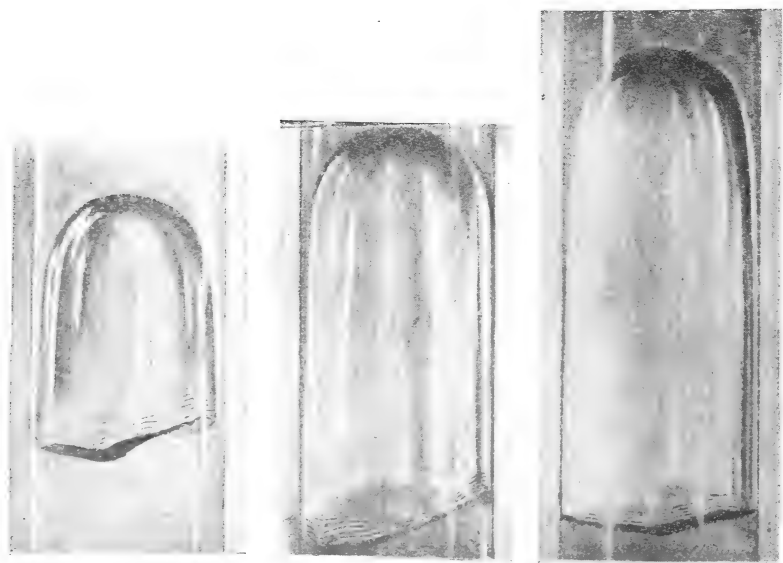
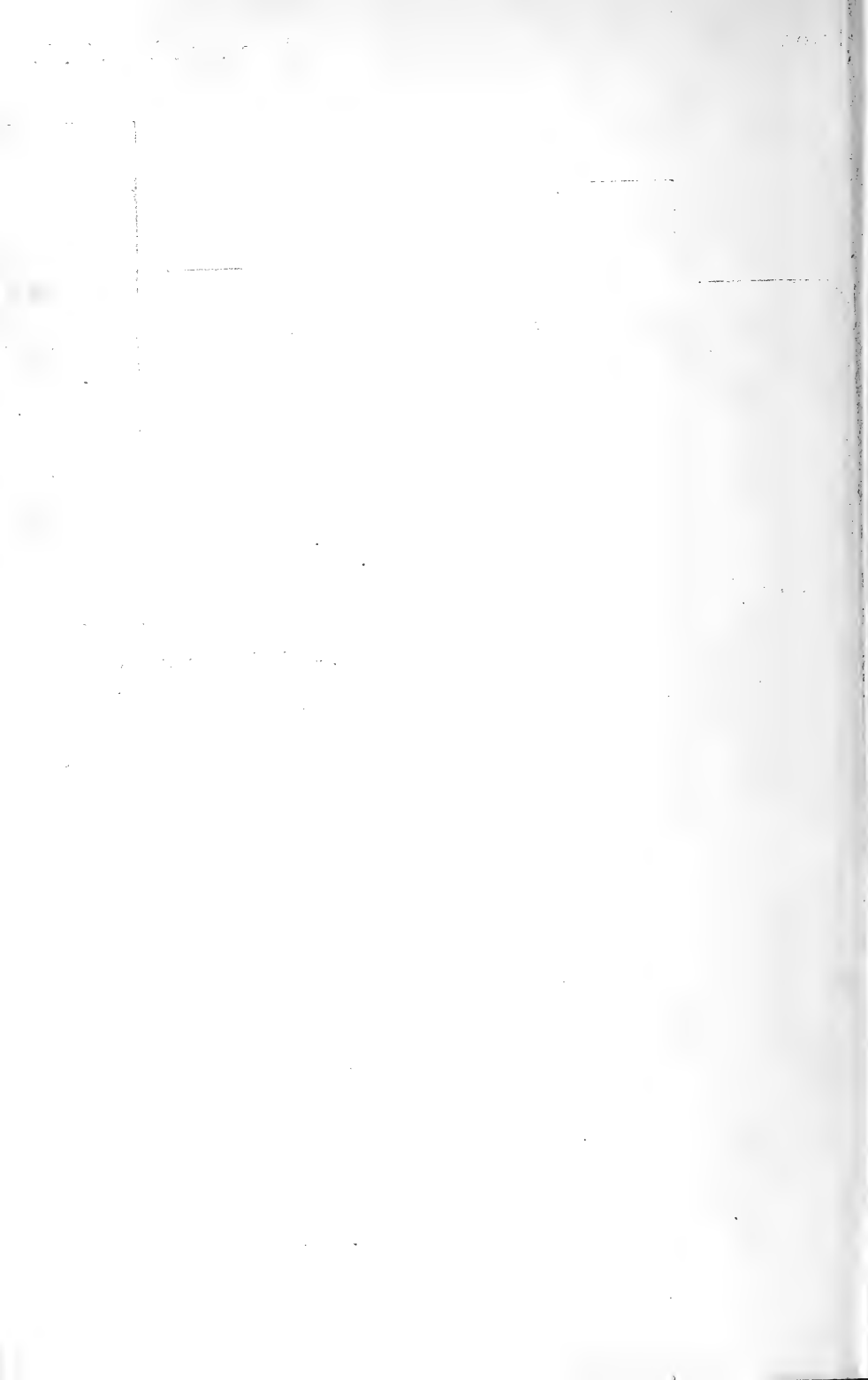
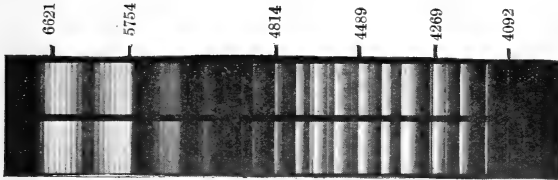

FIG. 3.—Tube diameter 2.695 cm.



NITROGEN.



Frequency = 0.22×10^6 per second.

do. = 1.10×10^6 per second.

Diameter of capillary = 1.4 mm.

Current = 0.2 ampere.

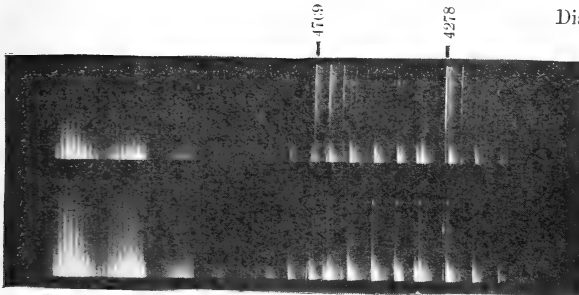

Diameter of capillary = 1.4 mm.

Negative bands clearly visible
Current = 0.16 ampere.

Negative bands just visible :
Current = 0.06 ampere.

Frequency = 1×10^6 per second.

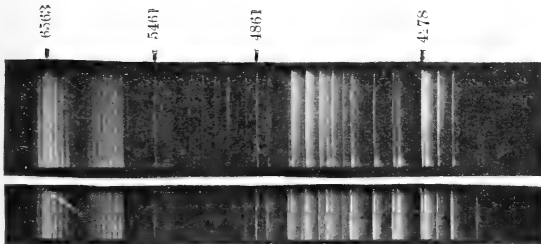

Current = 0.18 ampere.

Frequency = 0.2×10^6 per sec.

Diameter of capillary = 1.4 mm.

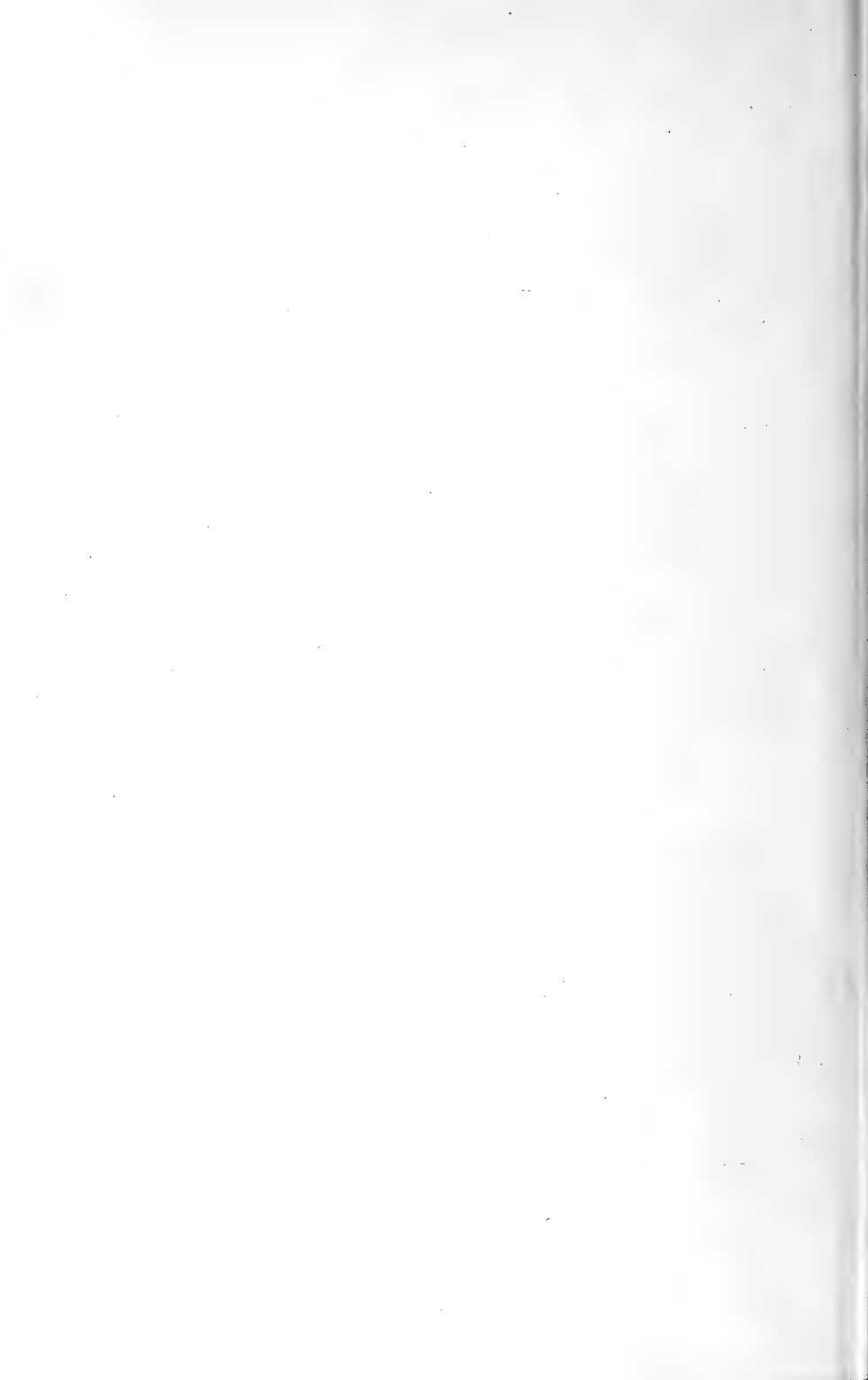

4

AIR.

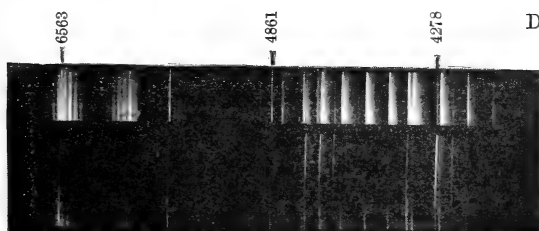

Diameter of capillary = 1.4 mm.

Capillary }
 Bulb. }
 Current = 0.3 amp.
 Volts = 3000.

5

HYDROGEN.

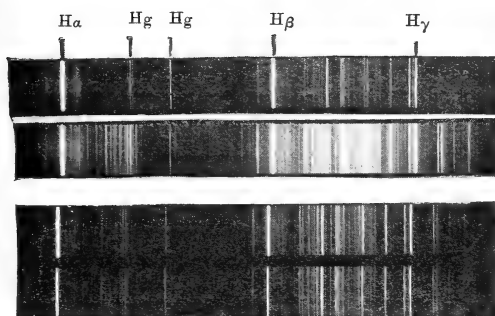

Diameter of capillary = 1.4 mm.

(a) Current = 0.262 amp. : Volts = 3000.

(b) Current = 0.110 amp. : Volts = 800.

(c) Current = 0.134 amp. : Volts = 1250.

(d) Current = 0.075 amp. : Volts = 700.

6

ARGON.

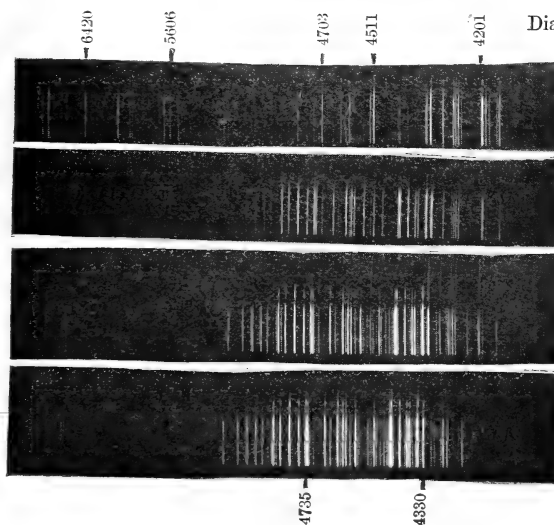

Diameter of capillary = 1.6 mm.

(a) Current = 0.07 amp. : Exposure = 30".

(b) Current = 0.15 amp. : Exposure = 10".

(c) Current = 0.27 amp. : Exposure = 40".

(d) Current = 0.30 amp. : Exposure = 60".

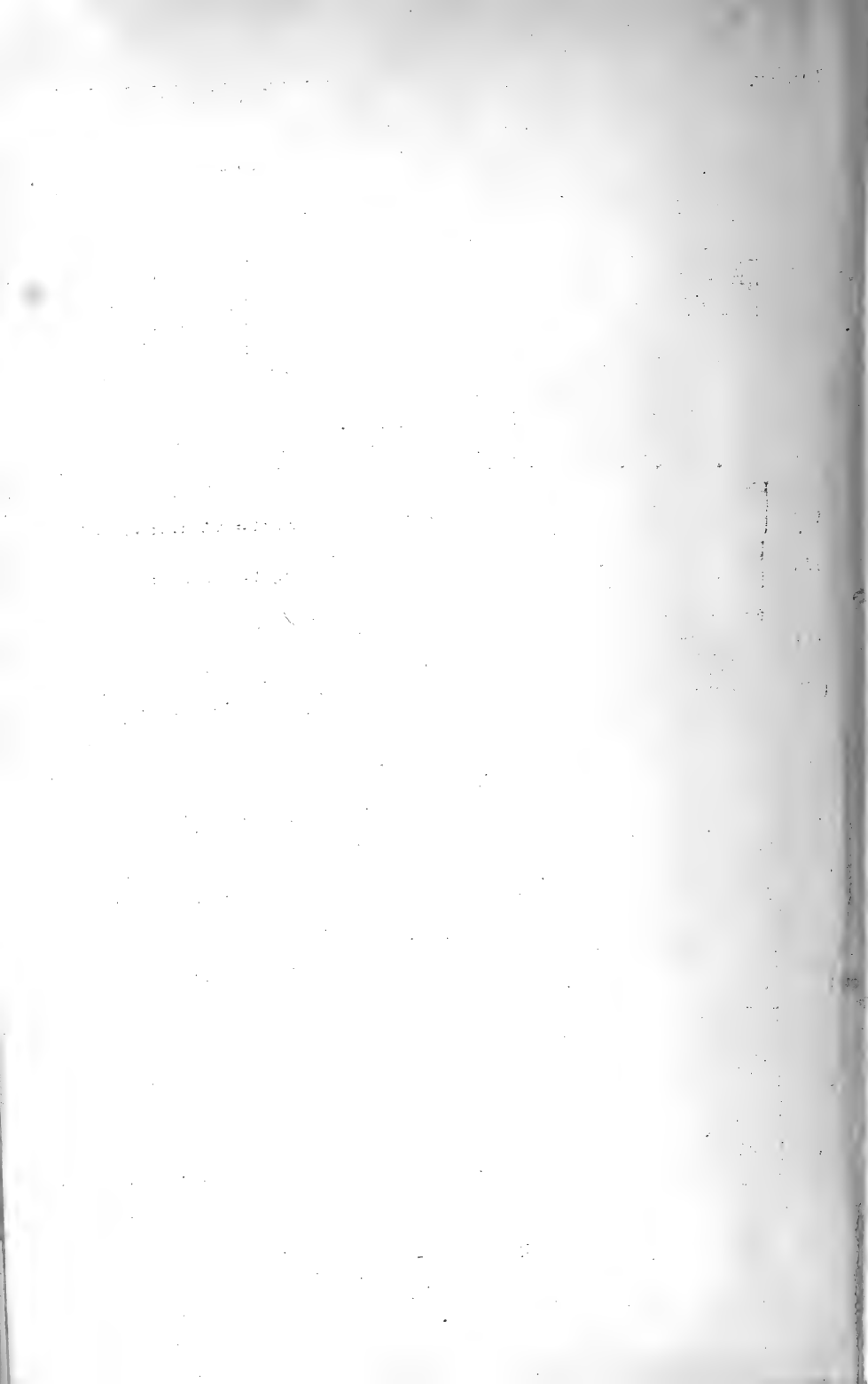

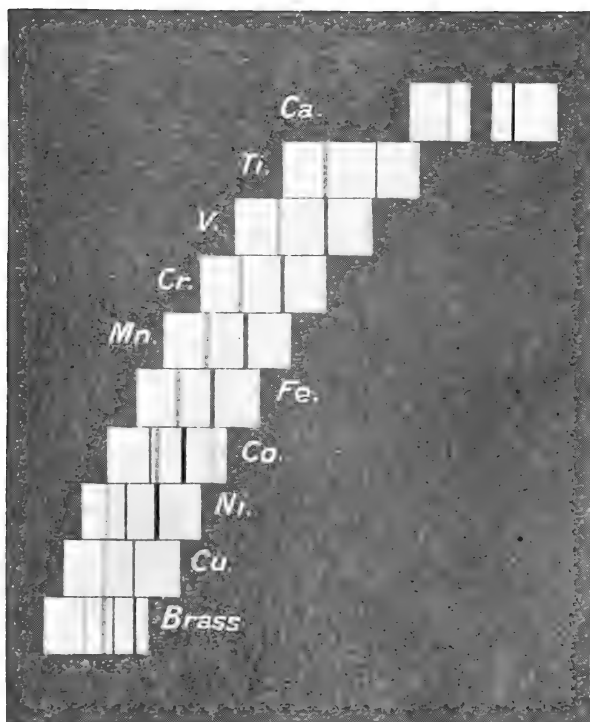

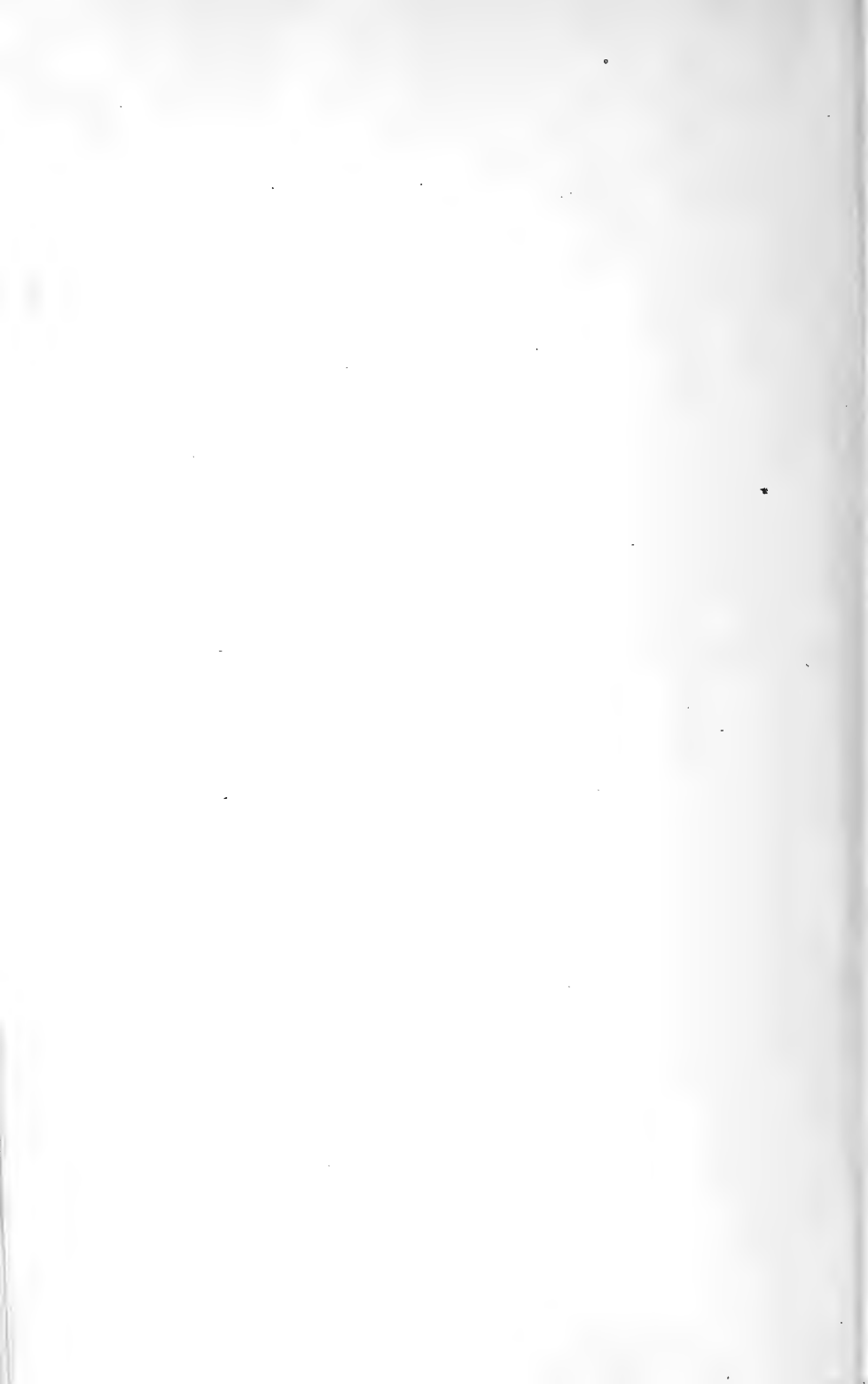

FIG. 4B.—SO₂. a/p X/ p (5 to 90) curve.
 (1) $p=2.84$ mm. (2) $p=20$ mm. (3) $p=16$ mm.

mm.

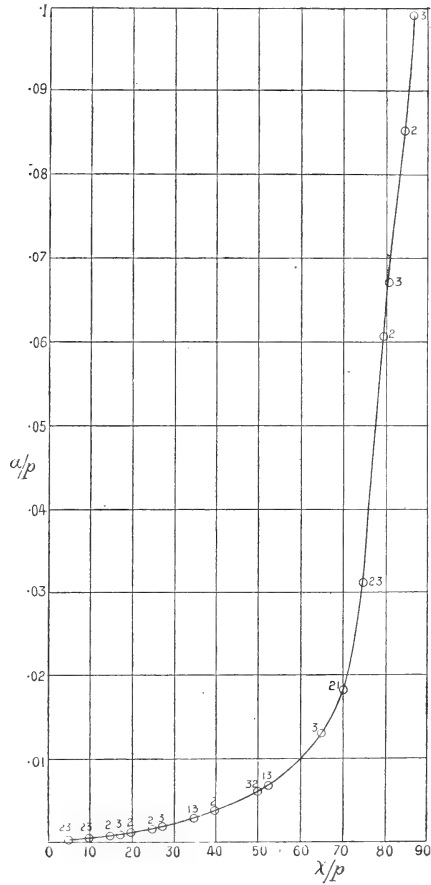

FIG. 1.—AIR.

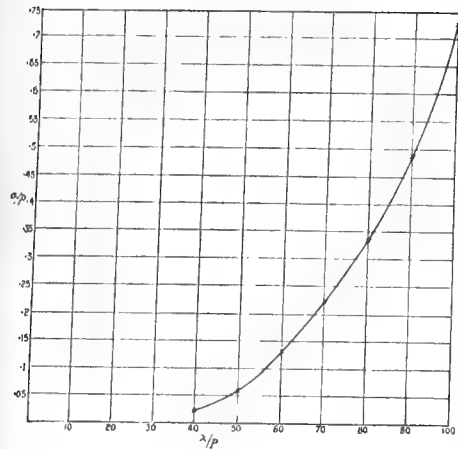

FIG. 2.—SO₂. Pressure 16 mm.

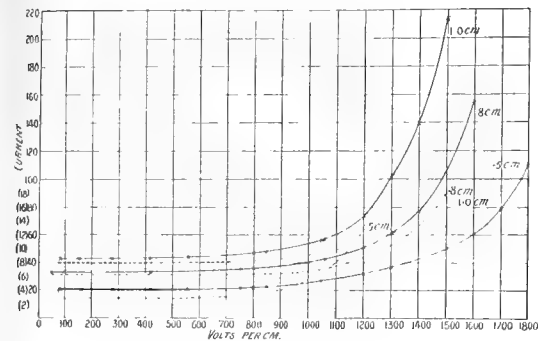

FIG. 3.—SO₂. Pressure 20 mm.

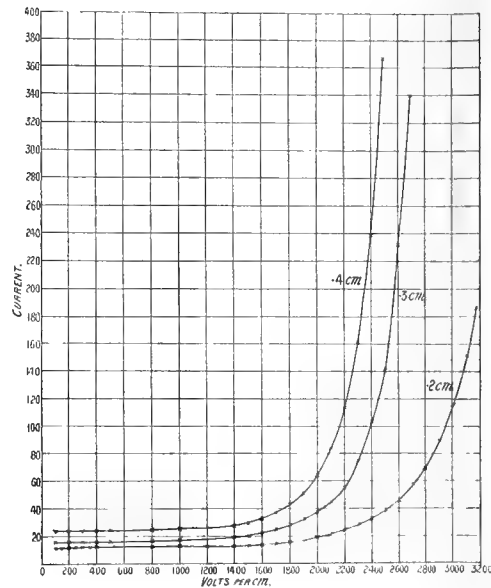

FIG. 4 A.—SO₂. a/p X/p curve.
(1) $p=2.84$ mm. (2) $p=20$ mm. (3) $p=16$ mm.

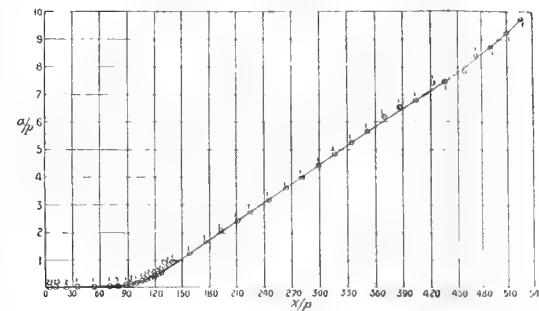
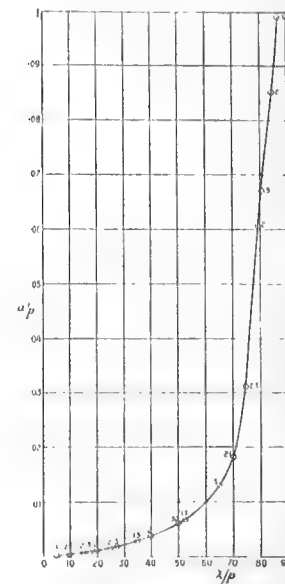

FIG. 4 B.—SO₂. a/p X/p (5 to 90) curve.
(1) $p=2.84$ mm. (2) $p=20$ mm. (3) $p=16$ mm.





INDEX to VOL. XXVI.

- ACTINIUM**, on the distribution of the active deposit of, in electric fields, 381; products, analysis of the gamma rays of the, 937; emanation, on the molecular weight of, 948.
- C, on the range of the recoil atoms from, 586.
- Air**, on the effect of ionization of, on electrical oscillations, 567; on the electrical conductivity imparted to liquid, by alpha rays, 876; on the high frequency discharge in, 976.
- bubbles, on the motion of long, in a vertical tube, 952.
- films, on electric currents through, 351.
- Alcohol and xylol**, on the electrical resistance of mixtures of, 1044.
- Alpha particles**, on the range and ionization of, in simple gases, 402; on the scattering of, by gases, 702.
- rays, on the electrical conductivity imparted to liquid air by, 876; on the recombination of ions made by, 991.
- Anderson (Prof. A.)** on electric currents through air-films, 351.
- Anode**, on the virtual, in the tubes for magnetic rays, 848.
- Antonoff (G. N.)** on the existence of uranium Y, 332, 1058.
- Arcs**, on the deposit on the poles of, 333.
- Argon**, on the high frequency discharge in, 978.
- Atomic weights**, on new multiple relations of the, 732.
- Atoms**, on the constitution of, 1, 476, 792, 857, 1044; on the formation of molecules with, as constituted on the corpuscular-ring theory, 25; on the energy required to ionize, 183.
- Barnett (Prof. S. J.)** on the magnetic field of two electromagnets in rotation, 987.
- Barton (Prof. E. H.)** on range and sharpness of resonance under sustained forcing and their variations with pitch, 111; on the effect of ionization of air on electrical oscillations, 567.
- Bateman (H.)** on corpuscular radiation, 579.
- Beatty (R. T.)** on the energy required to ionize an atom, 183.
- Bergwitz (Dr. K.)** on the electrification of the atmosphere, 375.
- Bessel function of zero order**, on a physical interpretation of the, 427.
- Beta rays**, notes on, 540; on the analysis of the, from radium B and radium C, 717.
- Beth (H. J. E.)** on the oscillations about a position of equilibrium, 268.
- Bohr (Dr. N.)** on the constitution of atoms and molecules, 1, 476, 857.
- Books, new**:—Results of Observations made at the Coast and Geodetic Survey Magnetic Observatory near Tucson, Arizona, 232; Perry's Elementary Practical Mathematics, 544; The Collected Mathematical Papers of James Joseph Sylvester, 545; Tarleton's Introduction to the Mathematical Theory of Attraction, 546; Patterson's Revolving Vectors, 546; Robb's Optical Geometry of Motion, 547; Schott's Electromagnetic Radiation and the Mechanical Reactions arising from it, 547; Silberstein's Vectorial Mechanics, 935; Bulletin of the Bureau of Standards, 936.
- Boon (J. R.)** on the effect of pressure on the electric wind from a discharging point, 694.
- Boswell (P. G. H.)** on the age of the Suffolk valleys, 379.
- Bromwich (Dr. T. J. P.A.)** on the ballistic galvanometer, 186.

- Bryson (F. S.) on the constitution of the mercury green line, 366.
- Bumstead (Prof. H. A.) on the velocities of delta rays, 233.
- Callendar (Prof. H. L.) on radiation and specific heat, 787.
- Campbell (Dr. N.) on the velocity of delta rays, 774; a special case of gaseous conduction, 912; on the electrical resistance of mixtures of xylol and alcohol, 1044.
- Cathode, on heating effects at the, in vacuum tubes, 411.
- Child (C. D.) on the line spectrum from uncharged molecules, 906.
- Compton (K. T.) on the photoelectric effect, 549.
- Conduction, on a case of anomalous, in a solid dielectric, 678; on a special case of gaseous, 912.
- Conway (Prof. A. W.) on an electromagnetic hypothesis as to the origin of series spectra, 1010.
- Cooke (Prof. H. L.) on the absorption of heat produced by the emission of ions from hot bodies, 472.
- Corpuscular radiation, on, 579.
- Crehore (Dr. A. C.) on the formation of the molecules of the elements and their compounds, 25.
- Darwin (C. G.) on the reflexion of the X-rays, 210.
- Deeley (R. M.) on the viscosity of glacier ice, 85.
- Delta rays, on the velocities of, 233, 774.
- Dielectric, on anomalous conduction in a solid, 678.
- Duffield (Prof. W. G.) on the deposit upon the poles of metallic arcs, 333.
- Earth, on the electrification of the surface of the, 375, 800; on the gradient of the penetrating radiation from the, 604; measurements of the penetrating radiation from the, 740; on a new method of determining the horizontal intensity of the magnetic field of the, 752.
- Electric conductivity, on the, imparted to liquid air by alpha rays, 876.
- currents, on the conveyance of, in metals, 345; on, through air films, 351.
- discharge, on the action of a magnetic field on the, through gases, 252; on low potential, in high vacua, 730, 902; on the spectra of high frequency, in Geissler tubes, 966.
- Electric fields, on the distribution of the active deposit of actinium in, 381.
- oscillations, on the effect of ionization of air on, 567.
- resistance of graphite, on the effect of temperature and magnetization on the, 158; of mixtures of xylol and alcohol, on the, 1044.
- wind from a discharging point, on the effect of pressure on the, 694.
- Electromagnetic hypothesis as to the origin of series spectra, on an, 1010.
- Electromagnets in rotation, on the magnetic field of two, 987.
- Electrometer, on a self-recording, 200; measurements on the earth's penetrating radiation with a Wulf, 740.
- Electrons, on the emission of, from tungsten at high temperatures, 345.
- Elements, on the high-frequency spectra of the, 1024.
- Ferguson (A.) on the forces acting on a solid sphere in contact with a liquid surface, 925.
- Fermat's law, on, 144.
- Fleck (A.) on the disintegration of uranium X, 528.
- Fletcher (A. L.) on a method for the determination of radium, 674.
- Flicker photometer and the iris, on the, 180.
- Fluid, on the motion of a viscous, 776; on the stability of the laminar motion of an inviscid, 1001.
- Galvanometer, on the ballistic, 186.
- Gamma rays, on interference phenomena with, 190; analysis of the, from radium D and radium E, 324; notes on, 540; on the scattering and absorption of the, of radium, 611, analysis of the, of the thorium and actinium products, 937.
- Gases, on the action of a magnetic field on the electric discharge through, 252; on the range and ionization of the alpha particles in simple, 402; on the scattering

- of alpha particles by, 702; on the distribution of energy in the spectra of, 801; on a special case of conduction in, 912; on ionization of, by collision, 1034.
- Geissler tubes, on the spectra of high frequency discharges in, 966.
- Geological Society, proceedings of the, 376, 548.
- Geometry, on a new solution to an historical theorem in, 984.
- Gibson (Prof. A. H.) on the motion of long air-bubbles in a vertical tube, 952.
- Glacier ice, on the viscosity of, 85.
- Glass, on the absolute thermal conductivity of, 598.
- Graphite, on the effect of temperature and magnetization on the resistance of, 158.
- Gravity, on a theory of, 636.
- Gray (Prof. A.) on the green mercury line, 366.
- Gray (J. A.) notes on beta and gamma rays, 540; on the scattering and absorption of the gamma rays of radium, 611.
- Heat, on the absorption of, by emission of ions from hot bodies, 472.
- Hodgson (Dr. B.) on heating effects at the cathode in vacuum tubes, 411.
- Hollingworth (J.) on a physical interpretation of the Bessel function of zero order, 427.
- Horton (Dr. F.) on low potential discharges in high vacua, 902.
- Hydrogen, on the high frequency discharge in, 976.
- Ice, on the viscosity of glacier, 85.
- Infinite series, on a method for the summation of a type of, 898.
- Interferometer, on the use of the, for the study of band spectra, 176.
- Inviscid fluid, on the stability of the laminar motion of an, 1001.
- Iodine, on resonance spectra of, under high dispersion, 828.
- Ionization, on columnar, 511; on the effect of, of air on electrical oscillations, 567; on, of gases by collision, 1034.
- Ions, on the, from hot salts, 452; on the absorption of heat produced by the emission of, 472; on the recombination of, made by alpha rays, 991.
- Iris, on the flicker photometer and the, 180.
- Jenkins (W. A.) on a new method of determining the horizontal intensity of the earth's magnetic field, 752.
- Jolly (H. L. P.) on the distribution of energy in the spectra of gases, 801.
- Jowett (A.) on the volcanic rocks of Forfarshire, 380.
- Keene (H. B.) on the transmission of X rays through metals, 712.
- Keys (D. A.) on the electrical conductivity imparted to liquid air by alpha rays, 876.
- Kilby (W. B.) on the effect of ionization of air on electrical oscillations, 567.
- King (L. V.) on the gradient of the penetrating radiation from the earth, 604.
- Lawson (R. W.) on the spectra of high frequency discharges in Geissler tubes, 966.
- Light, on the absorption of in heterogeneous media, 423; on the polarization of, of resonance spectra, 846; on Fermat's law of swiftest propagation of, 145.
- Line spectrum from uncharged molecules, on the, 906.
- Liquid surface, on the forces acting on a solid sphere in contact with a, 925.
- Livens (G. H.) on magneto-optical rotativity, 362; on the intrinsic optical rotativity of solutions, 535.
- Logie (J.) on the constitution of the mercury green line, 366.
- Low potential discharges in high vacua, on, 902.
- McLaren (Prof. S. B.) on a theory of gravity, 636; on the magneton and Planck's universal constant, 800.
- McLennan (Prof. J. C.) measurements on the earth's penetrating radiation with a Wulf electrometer, 740; on the electrical conductivity imparted to liquid air by alpha rays, 876.
- McLeod (A. R.), measurements on the earth's penetrating radiation with a Wulf electrometer, 740.

- Magnetic field, on the action of a, on the discharge through gases, 252; on a new method of determining the horizontal intensity of the earth's, 752; on the, of two electromagnets in rotation, 987.
- rays, on the virtual anode in the tubes for, 848.
- Magnetization, on the effect of, on the resistance of graphite, 158.
- Magneton, on the, and Planck's constant, 800.
- Magneto-optical rotativity, on, 362.
- Mainstone (P. A.) on heating effects at the cathode in vacuum tubes, 411.
- Mallik (Prof. D. N.) on Fermat's law, 144.
- Marsden (E.) on some experiments with the active deposit of thorium, 354; on a method for determining the molecular weights of radioactive emanations, 948.
- Mauchly (S. J.) on the action of a magnetic field upon the electric discharge through gases, 252.
- Mercury green line, on the constitution of the, 366.
- Metallic arcs, on the deposit on the poles of, 333.
- Metals, on the transmission of X rays through, 712.
- Molecular weights of radioactive emanations, on a method for determining the, 948.
- Molecules, on the constitution of atoms, and, 1, 476, 857; on the formation of the, of the elements, 25; on the line spectrum from uncharged, 906.
- More (Prof. L. T.) on the action of a magnetic field upon the electric discharge through gases, 252.
- Moseley (H. G. J.) on the reflexion of the X rays, 210; on the high-frequency spectra of the elements, 1024.
- Neon, on series of lines in the spectrum of, 981.
- Nitrogen, on the high frequency discharge in, 974.
- Nuttall (J. M.) on the scattering of alpha particles by gases, 702.
- Nutting (P. G.) on the absorption of light in heterogeneous media, 423.
- Odling (M.) on the bathonian rocks of the Oxford district, 376.
- Ogden (H.) on the recombination of ions made by alpha rays, 991.
- Oscillations about a position of equilibrium, on, 268.
- Oxygen, on the high frequency discharge in, 977.
- Parkinson (J.) on a group of metamorphosed sediments between Machakos and Lake Magadi, 548.
- Parr (P. H.) on the viscosity of glacier ice, 85.
- Patterson (J.) on a self-recording electrometer, 200.
- Photoelectric effect, on the, 549; on the long-wave limits of the normal, 1017.
- Photographic density, on, 423.
- Photometer, on the flicker, and the iris, 180.
- Pitch, on the variation of resonance with, 111.
- Planck's constant, on, 800.
- Pohl (Dr. R.) on the long-wave limits of the normal photoelectric effect, 1017.
- Potential, on the approximate solution of certain problems relating to the, 195.
- Pringsheim (Dr. P.) on the long-wave limits of the normal photoelectric effect, 1017.
- Radiation, on corpuscular, 579; on the earth's penetrating, 604, 740; on, and specific heat, 787.
- Radioactive emanations, on a method for determining the molecular weights of, 948.
- substances, on a method for the determination of radium in, 674.
- Radium, on the scattering and absorption of the gamma rays of, 611; on the distribution of the active deposit of, in an electric field, 623; on the determination of, in radioactive substances, 674.
- B, on the analysis of the beta rays from, 717.
- C, on the analysis of the beta rays from, 717.
- D, on the analysis of the gamma rays from, 324.
- E, on the analysis of the gamma rays from, 324.
- Rayleigh (Lord) on the approximate solution of certain problems

- relating to the potential, 195; on the motion of a viscous fluid, 776; on the stability of the laminar motion of an inviscid fluid, 1001.
- Resonance, on range and sharpness of, under sustained forcing, 111.
- Richardson (H.) analysis of the gamma rays from radium D and radium E, 324; analysis of the gamma rays of the thorium and actinium products, 937.
- Richardson (Prof. O. W.) on the emission of electrons from tungsten at high temperatures, 345; on the ions from hot salts, 452; on the absorption of heat produced by the emission of ions from hot bodies, 472; on the photoelectric effect, 549.
- Righi (Prof. A.) on the virtual anode in the tubes for magnetic rays, 848.
- Roberts (D. E.) on the effect of temperature and magnetization on the resistance of graphite, 158.
- Robinson (H.) on the analysis of the beta rays from radium B and radium C, 717.
- Rossi (R.) on series of lines in the spectrum of neon, 981.
- Rotativity, on magneto-optical, 362; on the intrinsic optical, of solutions, 535.
- Rudge (Prof. W. A. D.) on the electrification of the atmosphere and surface of the earth, 800.
- Rutherford (Prof. E.) analysis of the gamma rays from radium D and radium E, 324; on the scattering of alpha particles by gases, 702; analysis of the beta rays from radium B and radium C, 717; analysis of the gamma rays of the thorium and actinium products, 937.
- Salts, on the ions from hot, 452.
- Schwatt (Prof. I. J.) on the summation of a type of a family of trigonometric series, 895; on a method for the summation of a type of infinite series, 898.
- Series, on the summation of a type of a family of, 895; on a method for the summation of a type of infinite, 898.
- Shaw (A. N.) on interference phenomena with gamma rays, 190.
- Solutions, on the intrinsic optical rotativity of, 535.
- Sound, on plane waves of, 440.
- Southwell (R. V.) on the collapse of tubes by external pressure, 502.
- Specific heat, on radiation and, 787.
- Spectra, on the distribution of energy in the, of gases, 801; on resonance, of iodine under high dispersion, 328; on the polarization of the light of resonance, 846; on line, from uncharged molecules, 906; on the, of high frequency discharges in Geissler tubes, 966; on the use of the interferometer for the study of band, 176; on an electromagnetic hypothesis as to the origin of series, 1010; on the high frequency, of the elements, 1034.
- Spectrum, on series of lines in the, of neon, 981.
- Sphere, on the forces acting on a solid, in contact with a liquid surface, 925.
- Stevens (H. C.) on the flicker photometer and the iris, 180.
- Stewart (J. W.) on a new solution to an historical theorem in geometry, 984.
- Swann (Dr. W. F. G.) on a case of anomalous conduction in a solid dielectric, 678.
- Taylor (Dr. T. S.) on the range and ionization of the alpha particle in simple gases, 402.
- Thermal conductivity of glass, on the, 598.
- Thomson (Dr. J. A.) on the petrology of the Kalgoorlie goldfield, 377.
- Thomson (Sir J. J.) on the structure of the atom, 792, 1044.
- Thorium, experiments with the active deposit of, 354; analysis of the gamma rays of the, products, 938.
- C, on the range of the recoil atoms from, 586.
- Townsend (Prof. J. S.) on low potential discharges in high vacua, 730.
- Trigonometric series, on the summation of a type of a family of, 895.
- Tubes, on the collapse of, by external pressure, 502.

- Tungsten, on the emission of electrons from, at high temperatures, 345.
- Uranium X, on the disintegration of, 528.
- Y, on the existence of, 332, 1058.
- Vacuum tubes, on heating effects at the cathode in, 411.
- Vibrations of relation, on, 268.
- Viscous fluid, on the motion of a, 776.
- Walmsley (H. P.) on the distribution of the active deposit of actinium in electric fields, 381.
- Water, on the highest wave in deep, 1053.
- Wave, on the highest, in deep water, 1053.
- Wellisch (Prof. E. M.) on experiments on columnar ionization, 511; on the distribution of the active deposit of radium in an electric field, 623.
- Wheatley (F. W.) on ionization of gases by collision with low electric forces, 1634.
- Wilde (Dr. H.) on some new multiple relations of atomic weights, 732.
- Williams (I.) on the absolute thermal conductivity of glass, 598.
- Wilson (R. H.) on experiments with the active deposit of thorium, 354.
- Wilton (J. R.) on plane waves of sound, 440; on the highest wave in deep water, 1053.
- Wireless telegraphy, on ionization and, 567.
- Wood (A. B.) on the range of the recoil atoms from thorium C and actinium C, 586; on a method for determining the molecular weights of radioactive emanations, 948.
- Wood (Prof. R. W.) on the use of the interferometer for the study of band spectra, 176; on resonance spectra of iodine under high dispersion, 828; on the polarization of the light of resonance spectra, 846.
- Woodrow (Dr. J. W.), experiments on columnar ionization, 511.
- X rays, on the reflexion of the, 210; on the transmission of, through metals, 712.
- Xylol and alcohol, on the electrical resistance of mixtures of, 1044.

END OF THE TWENTY-SIXTH VOLUME.

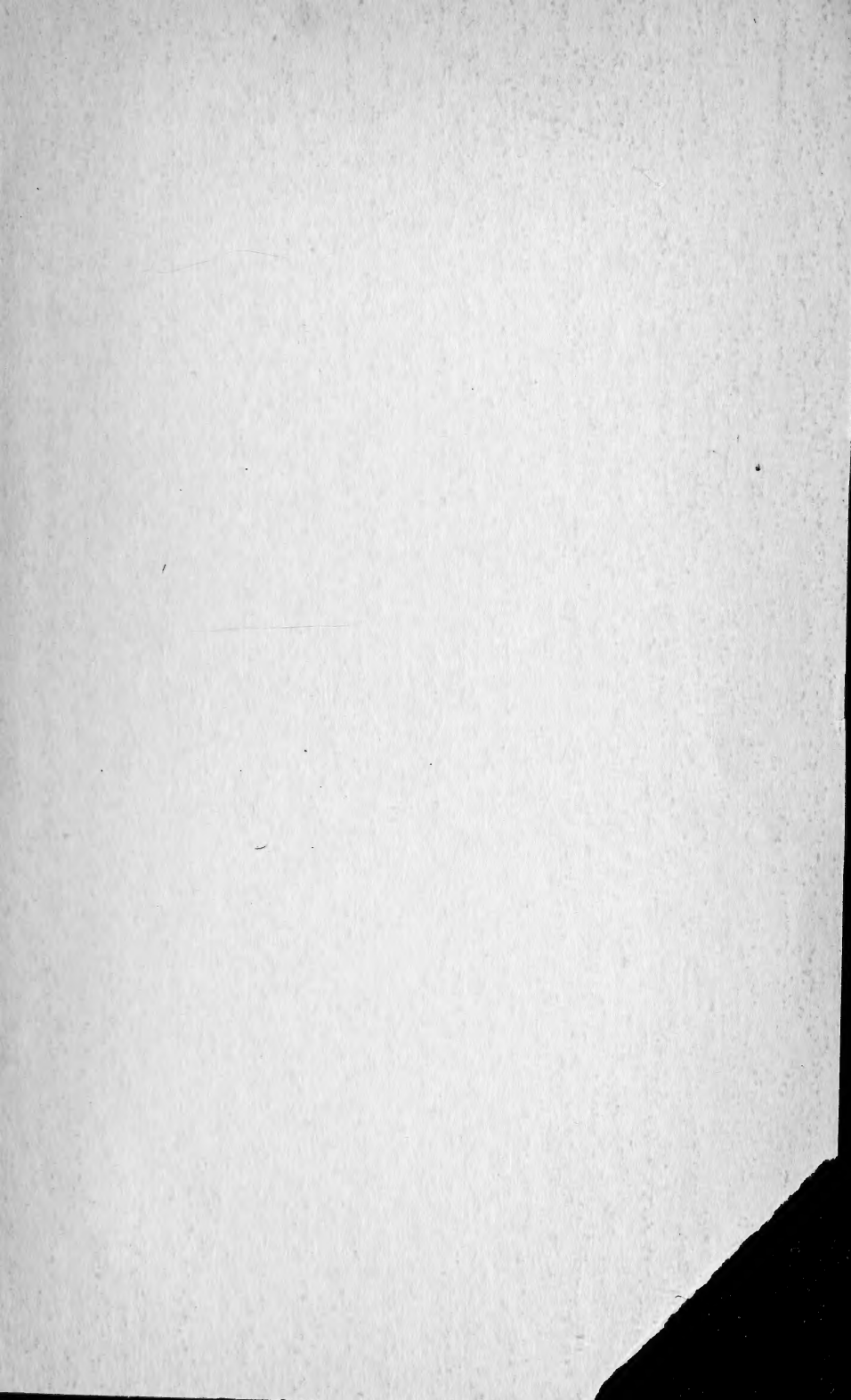

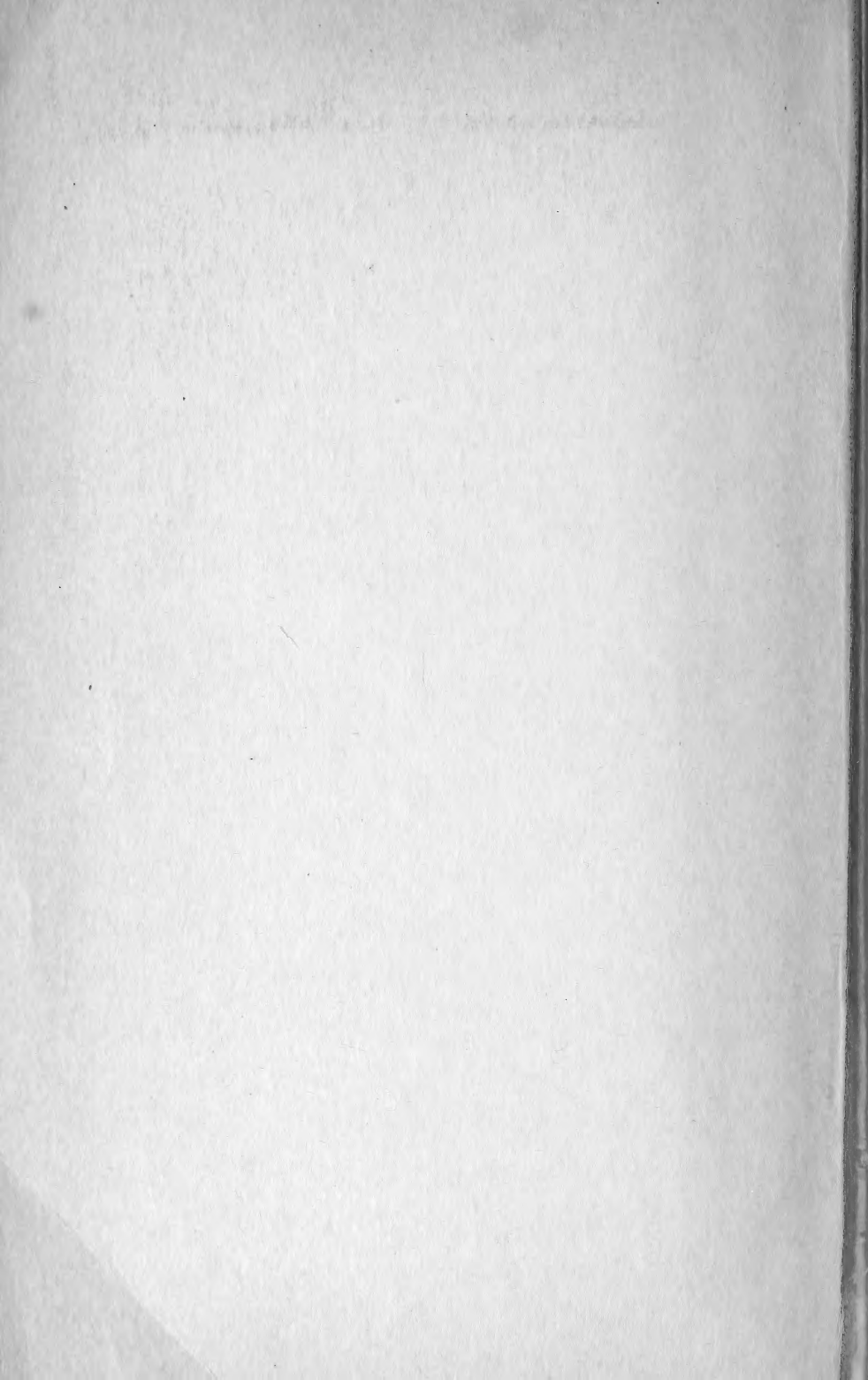

SMITHSONIAN INSTITUTION LIBRARIES



3 9088 01202 4923